

# System 300S

CP | 341-2CH71 | Manual

HB140 | CP | 341-2CH71 | en | 17-16

SPEED7 CP 341S-2RS422/485



YASKAWA Europe GmbH  
Hauptstraße 185  
65760 Eschborn  
Germany  
Tel.: +49 6196 569-300  
Fax: +49 6196 569-398  
Email: [info@yaskawa.eu.com](mailto:info@yaskawa.eu.com)  
Internet: [www.yaskawa.eu.com](http://www.yaskawa.eu.com)

## Table of contents

<b>1</b>	<b>General</b> .....	<b>4</b>
1.1	Copyright © YASKAWA Europe GmbH.....	4
1.2	About this manual.....	5
1.3	Safety information.....	6
<b>2</b>	<b>Basics</b> .....	<b>7</b>
2.1	Safety information for users.....	7
2.2	Hints for the project engineering.....	8
2.3	General data.....	11
2.3.1	Use in difficult operating conditions.....	12
<b>3</b>	<b>Assembly and installation guidelines</b> .....	<b>13</b>
3.1	Overview.....	13
3.2	Installation dimensions.....	14
3.3	Assembly SPEED-Bus.....	15
3.4	Installation guidelines.....	19
<b>4</b>	<b>Hardware description</b> .....	<b>21</b>
4.1	Properties.....	21
4.2	Structure.....	22
4.3	Technical data.....	26
<b>5</b>	<b>Deployment</b> .....	<b>29</b>
5.1	Fast introduction.....	29
5.2	Hardware configuration.....	30
5.2.1	Properties CP 341-2CH71.....	34
5.3	Communication with the user program.....	34
5.4	Firmware update.....	36
<b>6</b>	<b>Communication protocols</b> .....	<b>38</b>
6.1	Overview.....	38
6.2	ASCII.....	39
6.2.1	Basics ASCII.....	39
6.2.2	Proceeding.....	39
6.2.3	ASCII parameters.....	39
6.3	STX/ETX.....	42
6.3.1	Basics STX/ETX.....	42
6.3.2	Proceeding.....	42
6.3.3	STX/ETX parameters.....	42
<b>7</b>	<b>Accessing diagnostics messages</b> .....	<b>45</b>
7.1	Accessing diagnostics messages.....	45
7.2	Diagnostic messages.....	46

# 1 General

## 1.1 Copyright © YASKAWA Europe GmbH

### All Rights Reserved

This document contains proprietary information of Yaskawa and is not to be disclosed or used except in accordance with applicable agreements.

This material is protected by copyright laws. It may not be reproduced, distributed, or altered in any fashion by any entity (either internal or external to Yaskawa) except in accordance with applicable agreements, contracts or licensing, without the express written consent of Yaskawa and the business management owner of the material.

For permission to reproduce or distribute, please contact: YASKAWA Europe GmbH, European Headquarters, Hauptstraße 185, 65760 Eschborn, Germany

Tel.: +49 6196 569 300

Fax.: +49 6196 569 398

Email: [info@yaskawa.eu.com](mailto:info@yaskawa.eu.com)

Internet: [www.yaskawa.eu.com](http://www.yaskawa.eu.com)



*Every effort has been made to ensure that the information contained in this document was complete and accurate at the time of publishing. Nevertheless, the authors retain the right to modify the information.*

*This customer document describes all the hardware units and functions known at the present time. Descriptions may be included for units which are not present at the customer site. The exact scope of delivery is described in the respective purchase contract.*

### EC conformity declaration

Hereby, YASKAWA Europe GmbH declares that the products and systems are in compliance with the essential requirements and other relevant provisions. Conformity is indicated by the CE marking affixed to the product.

### Conformity Information

For more information regarding CE marking and Declaration of Conformity (DoC), please contact your local representative of YASKAWA Europe GmbH.

### Trademarks

VIPA, SLIO, System 100V, System 200V, System 300V, System 300S, System 400V, System 500S and Commander Compact are registered trademarks of YASKAWA Europe GmbH.

SPEED7 is a registered trademark of YASKAWA Europe GmbH.

SIMATIC, STEP, SINEC, TIA Portal, S7-300, S7-400 and S7-1500 are registered trademarks of Siemens AG.

Microsoft and Windows are registered trademarks of Microsoft Inc., USA.

Portable Document Format (PDF) and Postscript are registered trademarks of Adobe Systems, Inc.

All other trademarks, logos and service or product marks specified herein are owned by their respective companies.

### Document support

Contact your local representative of YASKAWA Europe GmbH if you have errors or questions regarding the content of this document. You can reach YASKAWA Europe GmbH via the following contact:

Email: [Documentation.HER@yaskawa.eu.com](mailto:Documentation.HER@yaskawa.eu.com)

**Technical support**

Contact your local representative of YASKAWA Europe GmbH if you encounter problems or have questions regarding the product. If such a location is not available, you can reach the Yaskawa customer service via the following contact:

YASKAWA Europe GmbH,  
European Headquarters, Hauptstraße 185, 65760 Eschborn, Germany  
Tel.: +49 6196 569 500 (hotline)  
Email: support@yaskawa.eu.com

## 1.2 About this manual

**Objective and contents**

This manual describes the CP 341-2CH71 of the System 300S from Yaskawa. It contains a description of the construction, project implementation and usage.

Product	Order number	as of state:	
		CP-HW	CP-FW
CP 341S-2RS422/485	341-2CH71	01	V1.0.0

**Target audience**

The manual is targeted at users who have a background in automation technology.

**Structure of the manual**

The manual consists of chapters. Every chapter provides a self-contained description of a specific topic.

**Guide to the document**

The following guides are available in the manual:

- An overall table of contents at the beginning of the manual
- References with page numbers

**Availability**

The manual is available in:

- printed form, on paper
- in electronic form as PDF-file (Adobe Acrobat Reader)

**Icons Headings**

Important passages in the text are highlighted by following icons and headings:

**DANGER!**

Immediate or likely danger. Personal injury is possible.

**CAUTION!**

Damages to property is likely if these warnings are not heeded.



*Supplementary information and useful tips.*

### 1.3 Safety information

#### Applications conforming with specifications

The system is constructed and produced for:

- communication and process control
- general control and automation tasks
- industrial applications
- operation within the environmental conditions specified in the technical data
- installation into a cubicle



#### **DANGER!**

This device is not certified for applications in

- in explosive environments (EX-zone)

#### Documentation

The manual must be available to all personnel in the

- project design department
- installation department
- commissioning
- operation



#### **CAUTION!**

**The following conditions must be met before using or commissioning the components described in this manual:**

- Hardware modifications to the process control system should only be carried out when the system has been disconnected from power!
- Installation and hardware modifications only by properly trained personnel.
- The national rules and regulations of the respective country must be satisfied (installation, safety, EMC ...)

#### Disposal

**National rules and regulations apply to the disposal of the unit!**

## 2 Basics

### 2.1 Safety information for users

#### Handling of electrostatic sensitive modules

The modules make use of highly integrated components in MOS-Technology. These components are extremely sensitive to over-voltages that can occur during electrostatic discharges. The following symbol is attached to modules that can be destroyed by electrostatic discharges.



The Symbol is located on the module, the module rack or on packing material and it indicates the presence of electrostatic sensitive equipment. It is possible that electrostatic sensitive equipment is destroyed by energies and voltages that are far less than the human threshold of perception. These voltages can occur where persons do not discharge themselves before handling electrostatic sensitive modules and they can damage components thereby, causing the module to become inoperable or unusable. Modules that have been damaged by electrostatic discharges can fail after a temperature change, mechanical shock or changes in the electrical load. Only the consequent implementation of protection devices and meticulous attention to the applicable rules and regulations for handling the respective equipment can prevent failures of electrostatic sensitive modules.

#### Shipping of modules

Modules must be shipped in the original packing material.

#### Measurements and alterations on electrostatic sensitive modules

When you are conducting measurements on electrostatic sensitive modules you should take the following precautions:

- Floating instruments must be discharged before use.
- Instruments must be grounded.

Modifying electrostatic sensitive modules you should only use soldering irons with grounded tips.



#### CAUTION!

Personnel and instruments should be grounded when working on electrostatic sensitive modules.

## 2.2 Hints for the project engineering

### Overview

For the project engineering of a SPEED7 system please follow this approach:

- Project engineering of the SPEED7-CPU and the internal DP master (if existing)
- Project engineering of the real plugged modules at the standard bus
- Project engineering of the internal Ethernet PG/OP channel after the real plugged modules as virtual CP 343-1 (Setting of IP address, subnet mask and gateway for online project engineering)
- Project engineering of an internal CP343 (if existing) as 2. CP 343-1
- Project engineering and connection of the SPEED-Bus-CPs res. -DP master as CP 343-1 (343-1EX11) res. CP 342-5 (342-5DA02 V5.0)
- Project engineering of all SPEED-Bus modules as single DP slaves in a virtual DP master module (SPEEDBUS.GSD required)



*Please do always use the corresponding CPU from Siemens in the hardware catalog to configure a CPU 31xS from Yaskawa. For the project engineering, a thorough knowledge of the SIMATIC manager and the hardware configurator from Siemens is required!*

### Requirements

The hardware configurator is part of the Siemens SIMATIC manager. It serves the project engineering. Please look at the hardware catalog for the modules that may be configured. For the deployment of the System 300S modules at the SPEED-Bus the inclusion of the System 300S modules into the hardware catalog via the GSD-file SPEEDBUS.GSD from Yaskawa is necessary.



**Approach**

**Standard bus**

Slot	Module
1	
2	<b>CPU ...</b>
X...	...
X...	...
3	

real modules at the standard bus

343-1EX11 (PG/OP)

343-1EX11 (only CPU 31xSN)

CPs res. DP master at the SPEED-Bus as 343-1EX11 res. 342-5DA02

342-5DA02 V5.0

virtual DP master for CPU and all SPEED-Bus modules

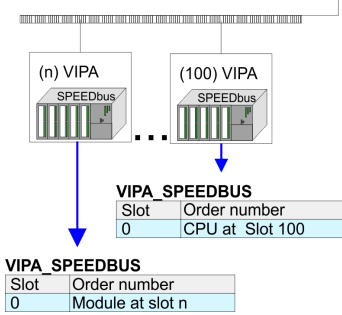

The project engineering of the SPEED7-CPU has the following components: To be compatible with the Siemens SIMATIC manager, the following steps are required:

1. **Preparation**  
Start the hardware configurator from Siemens and include the SPEEDBUS.GSD for the SPEED-Bus from Yaskawa.
2. **Project engineering of the CPU**  
Project the corresponding CPU. If your SPEED7-CPU contains a DP master, you may now connect it with PROFIBUS and configure your DP slaves.
3. **Project engineering of the real plugged modules at the standard bus**  
Set the modules that are at the right side of the CPU at the standard bus starting with slot 4.
4. **Project engineering of the integrated CPs**  
For the internal Ethernet PG/OP channel you have to set a CP 343-1 (343-1EX11) as 1. module at the real plugged modules. If your SPEED7-CPU has additionally an integrated CP 343, this is also configured as CP 343-1 but always below the former placed CP 343-1.
5. **Project engineering of the SPEED-Bus-CPs and -DP master**  
Plug and connect all CPs as 343-1EX11 and DP master as 342-5DA02 V5.0 at the SPEED-Bus below the former configured internal CPU components.

**i** Please regard that the sequence within a function group (CP res. DP master) corresponds the sequence at the SPEED-Bus from right to left.

6. **Project engineering of the CPU and all SPEED-Bus modules in a virtual master system**  
The slot assignment of the SPEED-Bus modules and the parameterization of the in-/output periphery happens via a virtual PROFIBUS DP master system. For this, place a DP master (342-5DA02 V5.0) with master system as last module. The PROFIBUS address must be < 100! Now include the slave "VIPA\_SPEEDBUS" for the CPU and every module at the SPEED-Bus. After the installation of the SPEEDBUS.GSD you may find this under *Profibus-DP / Additional field devices / I/O / VIPA\_SPEEDBUS*. Set the slot number of the module (100...110) as PROFIBUS address and plug the according module at slot 0 of the slave system.

**Bus extension with IM 360 and IM 361**

To extend the bus you may use the IM 360 from Siemens, where 3 further extensions racks can be connected via the IM 361. Bus extensions must be placed at slot 3. More detailed information is to be found in the chapter "Deployment CPU 31xS" at "Addressing".

Summary

The following illustration summarizes all project engineering steps:

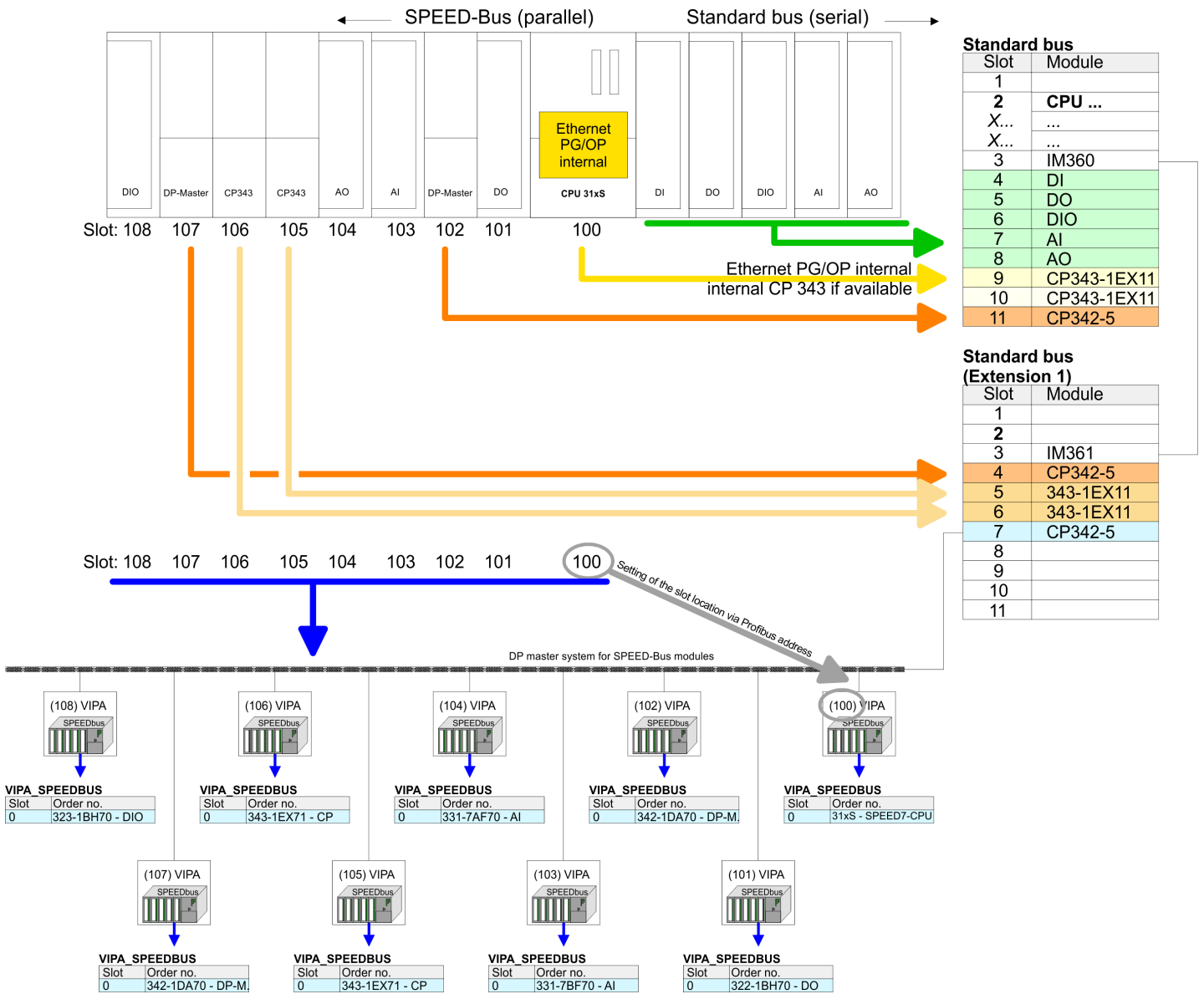

The according module is to be taken over from the HW catalog of VIPA\_SPEEDBUS on slot 0.



The sequence of the DPM and CP function groups is insignificant. You only have to take care to regard the sequence within a function group (DP1, DP2... res. CP1, CP2 ...).



**Hint, valid for all SPEED-Bus modules!**

The SPEED-Bus always requires the Siemens DP master CP 342-5 (342-5DA02 V5.0) as last module to be included, connected and parameterized to the operation mode DP master. Every SPEED-Bus module has to be connected as VIPA\_SPEED-Bus slave into this master system. By setting the SPEED-Bus slot number via the PROFIBUS address and by including the according SPEED-Bus module at slot 0, the SIMATIC manager receives information about the modules at the SPEED-Bus.

## 2.3 General data

### Conformity and approval

Conformity		
CE	2014/35/EU	Low-voltage directive
	2014/30/EU	EMC directive
Approval		
UL		Refer to Technical data
others		
RoHS	2011/65/EU	Restriction of the use of certain hazardous substances in electrical and electronic equipment

### Protection of persons and device protection

Type of protection	-	IP20
Electrical isolation		
to the field bus	-	electrically isolated
to the process level	-	electrically isolated
Insulation resistance		-
Insulation voltage to reference earth		
Inputs / outputs	-	AC / DC 50V, test voltage AC 500V
Protective measures	-	against short circuit

### Environmental conditions to EN 61131-2

Climatic		
Storage / transport	EN 60068-2-14	-25...+70°C
Operation		
Horizontal installation hanging	EN 61131-2	0...+60°C
Horizontal installation lying	EN 61131-2	0...+55°C
Vertical installation	EN 61131-2	0...+50°C
Air humidity	EN 60068-2-30	RH1 (without condensation, rel. humidity 10...95%)
Pollution	EN 61131-2	Degree of pollution 2
Installation altitude max.	-	2000m
Mechanical		
Oscillation	EN 60068-2-6	1g, 9Hz ... 150Hz
Shock	EN 60068-2-27	15g, 11ms

General data > Use in difficult operating conditions

### Mounting conditions

Mounting place	-	In the control cabinet
Mounting position	-	Horizontal and vertical

EMC	Standard	Comment
Emitted interference	EN 61000-6-4	Class A (Industrial area)
Noise immunity zone B	EN 61000-6-2	Industrial area
	EN 61000-4-2	ESD 8kV at air discharge (degree of severity 3), 4kV at contact discharge (degree of severity 2)
	EN 61000-4-3	HF field immunity (casing) 80MHz ... 1000MHz, 10V/m, 80% AM (1kHz) 1.4GHz ... 2.0GHz, 3V/m, 80% AM (1kHz) 2GHz ... 2.7GHz, 1V/m, 80% AM (1kHz)
	EN 61000-4-6	HF conducted 150kHz ... 80MHz, 10V, 80% AM (1kHz)
	EN 61000-4-4	Burst, degree of severity 3
	EN 61000-4-5	Surge, degree of severity 3 *

\*) Due to the high-energetic single pulses with Surge an appropriate external protective circuit with lightning protection elements like conductors for lightning and overvoltage is necessary.

### 2.3.1 Use in difficult operating conditions



*Without additional protective measures, the products must not be used in locations with difficult operating conditions; e.g. due to:*

- *dust generation*
- *chemically active substances (corrosive vapors or gases)*
- *strong electric or magnetic fields*

## 3 Assembly and installation guidelines

### 3.1 Overview

#### SPEED-Bus

- The SPEED-Bus is a 32bit parallel bus developed from Yaskawa.
- Via the SPEED-Bus you may connect up to 10 SPEED-Bus modules to your CPU.
- In opposite to the "standard" backplane bus where the modules are plugged-in at the right side of the CPU by means of single bus connectors, the modules at the SPEED-Bus are plugged-in at the left side of the CPU via a special SPEED-Bus rail.
- Yaskawa delivers profile rails with integrated SPEED-Bus for 2, 6, or 10 SPEED-Bus peripheral modules with different lengths.
- Each SPEED-Bus rail has a slot for an external power supply. This allows you to raise the maximum current at the back plane bus. Only the "SLOT1 DCDC" allows you to plug-in either a SPEED-Bus module or an additional power supply (307-1FB70).

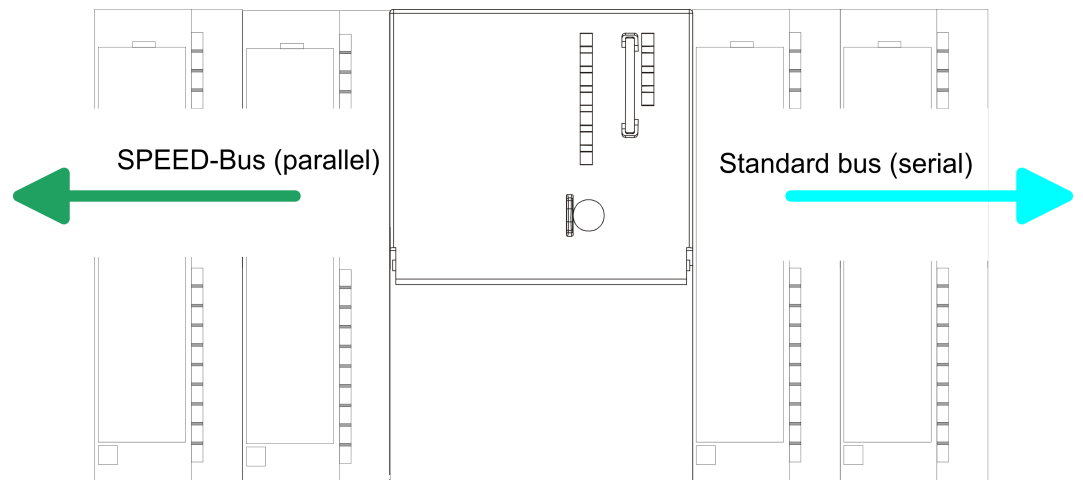

#### SPEED-Bus peripheral modules

The SPEED-Bus peripheral modules may exclusively be plugged into the SPEED-Bus slots at the left side of the CPU. The following SPEED-Bus modules are in preparation:

- Fast fieldbus modules like PROFIBUS DP, Interbus, CANopen master and CANopen slave
- Fast CP 343 (CP 343 Communication processor for Ethernet)
- Fast CP 341 with double RS 422/485 interface
- Fast digital input-/output modules (Fast Digital IN/OUT)

#### Serial Standard bus

The single modules are directly installed on a profile rail and connected via the backplane bus coupler. Before installing the modules you have to clip the backplane bus coupler to the module from the backside. The backplane bus couplers are included in the delivery of the peripheral modules.

#### Parallel SPEED-Bus

With SPEED-Bus the bus connection happens via a SPEED-Bus rail integrated in the profile rail at the left side of the CPU. Due to the parallel SPEED-Bus not all slots must be occupied in sequence.

#### SLOT 1 for additional power supply

At slot (SLOT 1 DCDC) you may plug either a SPEED-Bus module or an additional power supply.

Installation dimensions

**Assembly possibilities**

You may assemble the System 300 horizontally, vertically or lying. Please regard the allowed environment temperatures:

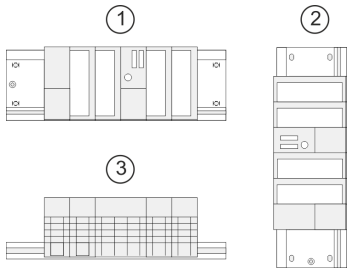

- 1 horizontal assembly: from 0 to 60°C
- 2 vertical assembly: from 0 to 50°C
- 3 lying assembly: from 0 to 55°C

**3.2 Installation dimensions**

**Dimensions Basic enclosure**

1tier width (WxHxD) in mm: 40 x 125 x 120

**Dimensions**

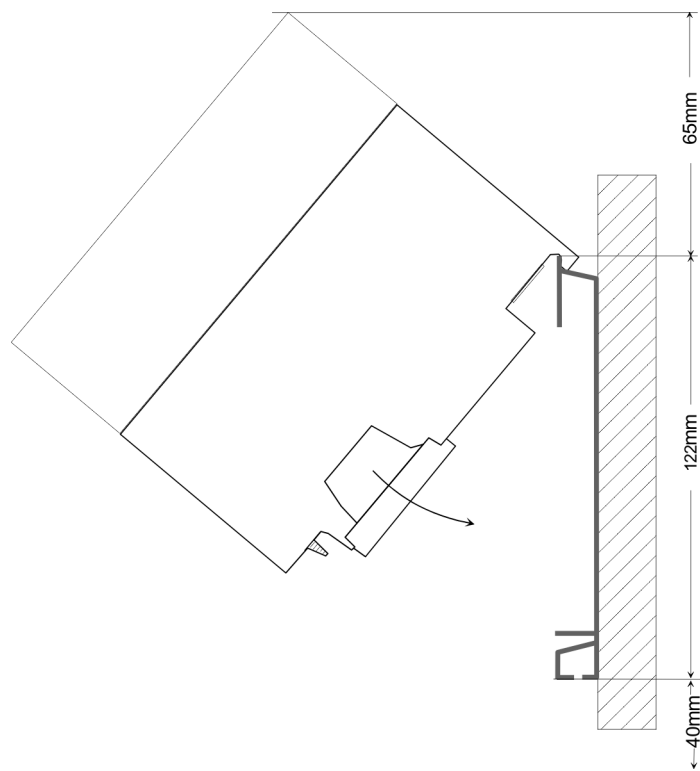

**Installation dimensions**

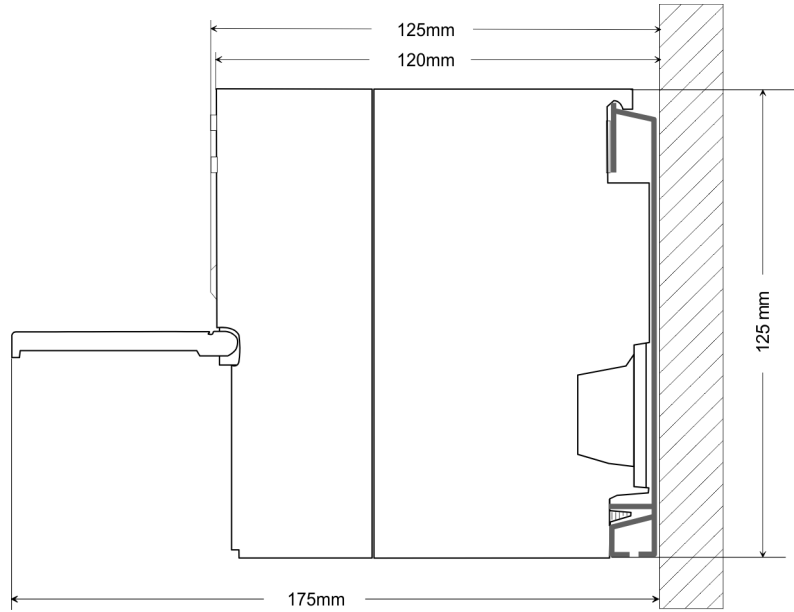

**3.3 Assembly SPEED-Bus**

**Pre-manufactured SPEED-Bus profile rail**

For the deployment of SPEED-Bus modules, a pre-manufactured SPEED-Bus rail is required. This is available mounted on a profile rail with 2, 6 or 10 extension slots.



**Dimensions**

Order number	Number of modules SPEED-Bus/Standard bus	A	B	C	D	E
391-1AF10	2/6	530	100	268	510	10
391-1AF30	6/2	530	100	105	510	10
391-1AF50	10/0	530	20	20	510	10
391-1AJ10	2/15	830	22	645	800	15
391-1AJ30	6/11	830	22	480	800	15
391-1AJ50	10/7	830	22	320	800	15

Measures in mm

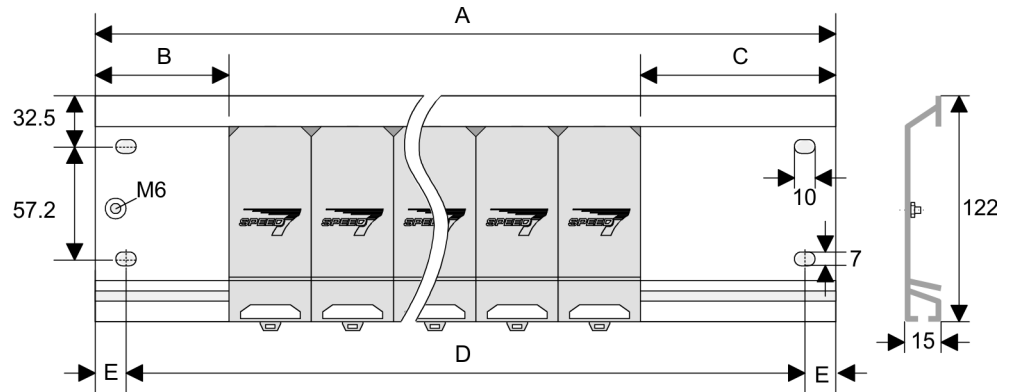

**Installation of the profile rail**

1. Bolt the profile rail with the background (screw size: M6), so that you still have minimum 65mm space above and 40mm below the profile rail. Please look for a low-impedance connection between profile rail and background.

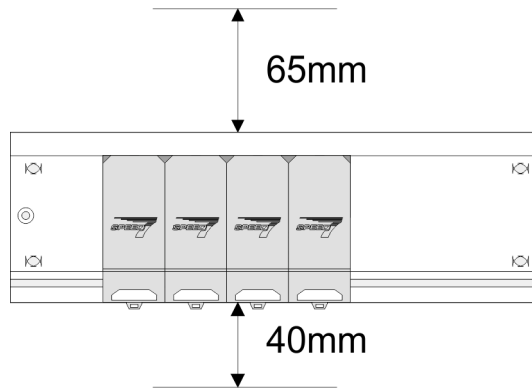

2. Connect the profile rail with the protected earth conductor. The minimum cross-section of the cable to the protected earth conductor has to be 10mm<sup>2</sup>.

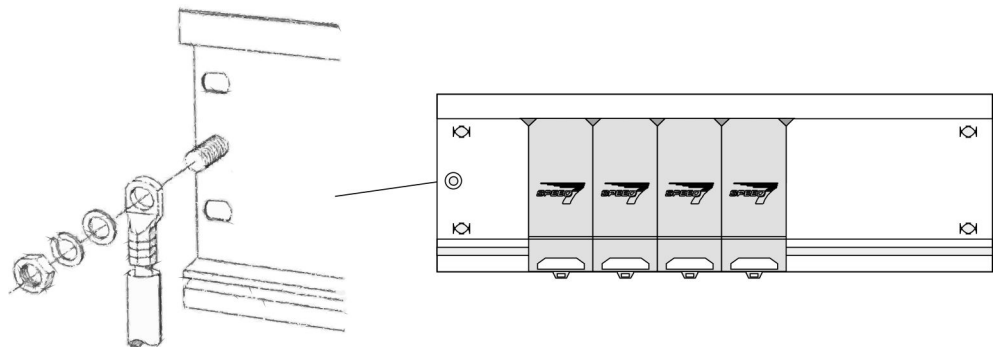



**Installation SPEED-Bus module**

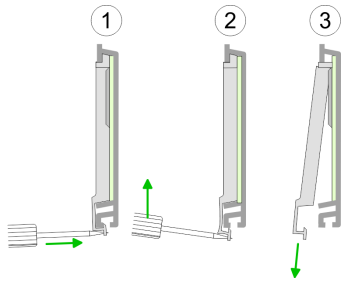

1. Dismantle the according protection flaps of the SPEED-Bus slot with a screw driver (open and pull down).

For the SPEED-Bus is a parallel bus, not every SPEED-Bus slot must be used in series. Leave the protection flap installed at an unused SPEED-Bus slot.

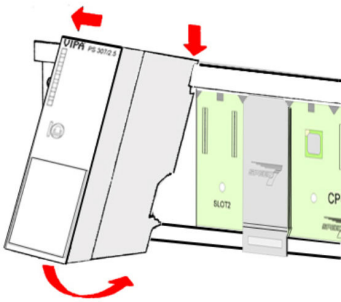

2. At deployment of a DC 24V power supply, install it at the shown position at the profile rail at the left side of the SPEED-Bus and push it to the left to the isolation bolt of the profile rail.
3. Fix the power supply by screwing.

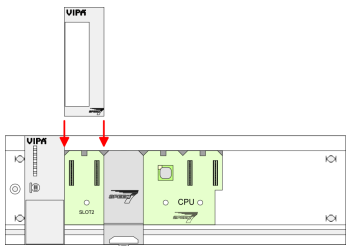

4. To connect the SPEED-Bus modules, plug it between the triangular positioning helps to a slot marked with "SLOT ..." and pull it down.
5. Only the "SLOT1 DCDC" allows you to plug-in either a SPEED-Bus module or an additional power supply.
6. Fix the CPU by screwing.

**Installation CPU without Standard-Bus-Modules**

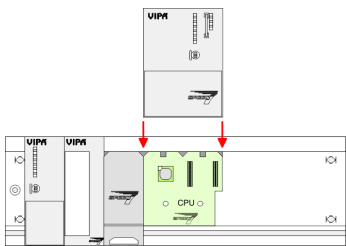

1. To deploy the SPEED7-CPU exclusively at the SPEED-Bus, plug it between the triangular positioning helps to the slot marked with "CPU SPEED7" and pull it down.

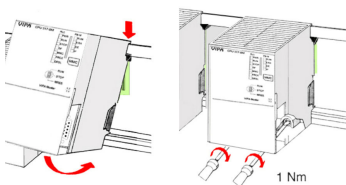

2. Fix the CPU by screwing.

**Installation CPU with Standard-Bus-Modules**

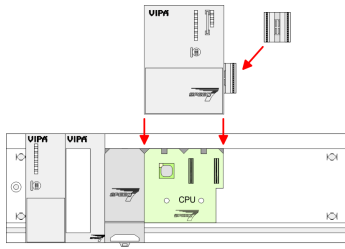

1. ➔ If also standard modules shall be plugged, take a bus coupler and click it at the CPU from behind like shown in the picture. Plug the CPU between the triangular positioning helps to the slot marked with "CPU SPEED7" and pull it down.

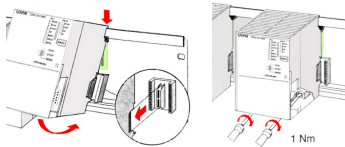

2. ➔ Fix the CPU by screwing.

**Installation Standard-Bus-Modules**

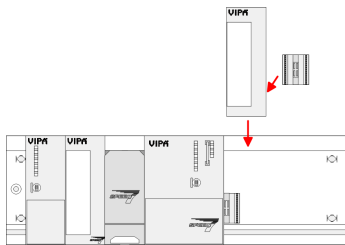

➔ Repeat this procedure with the peripheral modules, by clicking a backplane bus coupler, stick the module right from the modules you've already fixed, click it downwards and connect it with the backplane bus coupler of the last module and bolt it.



**CAUTION!**

- The power supplies must be released before installation and repair tasks, i.e. before handling with the power supply or with the cabling you must disconnect current/voltage (pull plug, at fixed connection switch off the concerning fuse)!
- Installation and modifications only by properly trained personnel!

## 3.4 Installation guidelines

### General

The installation guidelines contain information about the interference free deployment of a PLC system. There is the description of the ways, interference may occur in your PLC, how you can make sure the electromagnetic compatibility (EMC), and how you manage the isolation.

### What does EMC mean?

Electromagnetic compatibility (EMC) means the ability of an electrical device, to function error free in an electromagnetic environment without being interfered respectively without interfering the environment.

The components of Yaskawa are developed for the deployment in industrial environments and meets high demands on the EMC. Nevertheless you should project an EMC planning before installing the components and take conceivable interference causes into account.

### Possible interference causes

Electromagnetic interferences may interfere your control via different ways:

- Electromagnetic fields (RF coupling)
- Magnetic fields with power frequency
- Bus system
- Power supply
- Protected earth conductor

Depending on the spreading medium (lead bound or lead free) and the distance to the interference cause, interferences to your control occur by means of different coupling mechanisms.

There are:

- galvanic coupling
- capacitive coupling
- inductive coupling
- radiant coupling

### Basic rules for EMC

In the most times it is enough to take care of some elementary rules to guarantee the EMC. Please regard the following basic rules when installing your PLC.

- Take care of a correct area-wide grounding of the inactive metal parts when installing your components.
  - Install a central connection between the ground and the protected earth conductor system.
  - Connect all inactive metal extensive and impedance-low.
  - Please try not to use aluminium parts. Aluminium is easily oxidizing and is therefore less suitable for grounding.
- When cabling, take care of the correct line routing.
  - Organize your cabling in line groups (high voltage, current supply, signal and data lines).
  - Always lay your high voltage lines and signal respectively data lines in separate channels or bundles.
  - Route the signal and data lines as near as possible beside ground areas (e.g. suspension bars, metal rails, tin cabinet).

- Proof the correct fixing of the lead isolation.
  - Data lines must be shielded.
  - Analog lines must be shielded. When transmitting signals with small amplitudes the one sided laying of the isolation may be favourable.
  - Cables for frequency inverters, servo and stepper motors must be shielded.
  - Lay the line isolation extensively on an isolation/protected earth conductor rail directly after the cabinet entry and fix the isolation with cable clamps.
  - Make sure that the isolation/protected earth conductor rail is connected impedance-low with the cabinet.
  - Use metallic or metallised plug cases for isolated data lines.
- In special use cases you should appoint special EMC actions.
  - Consider to wire all inductivities with erase links.
  - Please consider luminescent lamps can influence signal lines.
- Create a homogeneous reference potential and ground all electrical operating supplies when possible.
  - Please take care for the targeted employment of the grounding actions. The grounding of the PLC serves for protection and functionality activity.
  - Connect installation parts and cabinets with your PLC in star topology with the isolation/protected earth conductor system. So you avoid ground loops.
  - If there are potential differences between installation parts and cabinets, lay sufficiently dimensioned potential compensation lines.

**Isolation of conductors**

Electrical, magnetically and electromagnetic interference fields are weakened by means of an isolation, one talks of absorption. Via the isolation rail, that is connected conductive with the rack, interference currents are shunt via cable isolation to the ground. Here you have to make sure, that the connection to the protected earth conductor is impedance-low, because otherwise the interference currents may appear as interference cause.

When isolating cables you have to regard the following:

- If possible, use only cables with isolation tangle.
- The hiding power of the isolation should be higher than 80%.
- Normally you should always lay the isolation of cables on both sides. Only by means of the both-sided connection of the isolation you achieve high quality interference suppression in the higher frequency area. Only as exception you may also lay the isolation one-sided. Then you only achieve the absorption of the lower frequencies. A one-sided isolation connection may be convenient, if:
  - the conduction of a potential compensating line is not possible.
  - analog signals (some mV respectively  $\mu\text{A}$ ) are transferred.
  - foil isolations (static isolations) are used.
- With data lines always use metallic or metallised plugs for serial couplings. Fix the isolation of the data line at the plug rack. Do not lay the isolation on the PIN 1 of the plug bar!
- At stationary operation it is convenient to strip the insulated cable interruption free and lay it on the isolation/protected earth conductor line.
- To fix the isolation tangles use cable clamps out of metal. The clamps must clasp the isolation extensively and have well contact.
- Lay the isolation on an isolation rail directly after the entry of the cable in the cabinet. Lead the isolation further on to your PLC and don't lay it on there again!



**CAUTION!**

**Please regard at installation!**

At potential differences between the grounding points, there may be a compensation current via the isolation connected at both sides.

Remedy: Potential compensation line

## 4 Hardware description

### 4.1 Properties

#### CP 341-2CH71

- RS422/485 interface isolated to back plane bus
- The following protocols are supported:
  - ASCII
  - STX/ETX
- Parameterization via GSD file
- Up to 250 telegrams within the 1024byte sized receive and send buffer
- Baud rate parameterizable up to 115.2kbit/s
- Integrated diagnostics buffer each CP
- Power supply via back plane bus

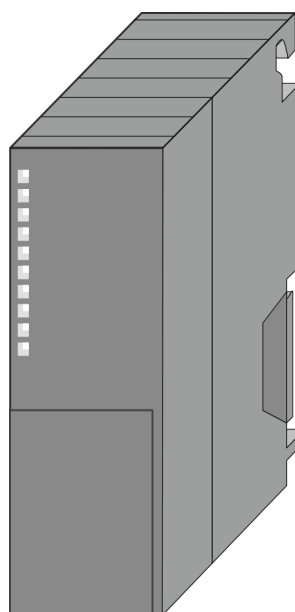

#### Order data

Type	Order No	Description
CP 341S-2RS422/485	341-2CH71	CP 341S with double RS422/485 interface Protocols: ASCII, STX/ETX

## 4.2 Structure

### CP 341-2CH71

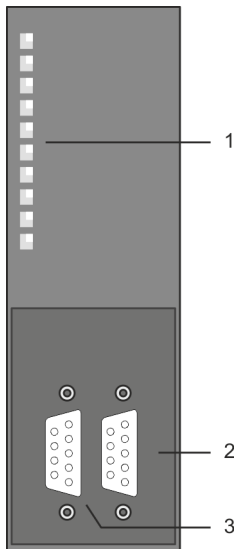

- 1 LED status indicators  
The following components are under the front flap:
- 2 RS422/485 COM1 interface
- 3 RS422/485 COM2 interface

**RS422/485 interface**

- Logical conditions as voltage difference between 2 twisted lines
- Serial bus connection
  - Full-duplex: four-wire operation (RS422)
  - Half-duplex: two-wire operation (RS485)
- Data transfer rate up to 115.2kbit/s

RS422/485  
X2

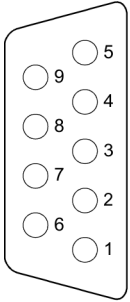

- ① n. c.
- ② T(B)+
- ③ R(B)+
- ④ RTS
- ⑤ M5V (GND\_ISO)
- ⑥ P5V (+5V\_ISO)
- ⑦ T(A)-
- ⑧ R(A)-
- ⑨ n.c.

CP341 - RS422

Periphery

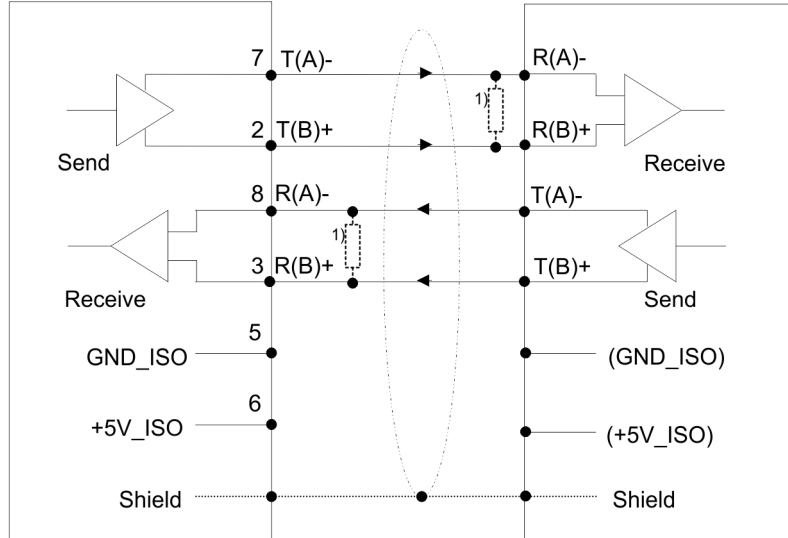

RS422/485  
X3

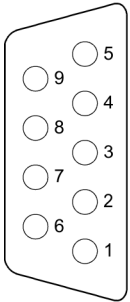

- ① n. c.
- ② T(B)+
- ③ R(B)+
- ④ RTS
- ⑤ M5V (GND\_ISO)
- ⑥ P5V (+5V\_ISO)
- ⑦ T(A)-
- ⑧ R(A)-
- ⑨ n.c.

CP341 - RS485

Periphery

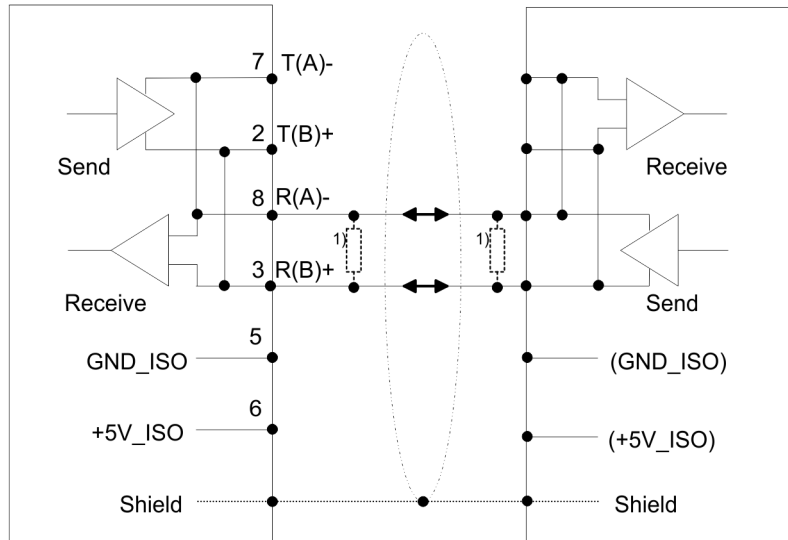

1) In the case of cables > 50m you have to solder in a terminating resistor of approximately 330Ω on the receiver for data free traffic.

Pin	Designation	Input/Output	Signal description
1	n.c.	-	reserved
2	T(B)+	Output	Send data (four-wire)
3	R(B)+R(B)+/T(B)+	Input Input/Output	Receive data (four-wire) Receive/Send data (two-wire)
4	RTS	Output	Request to send: RTS "ON": CP ready to send RTS "OFF": CP is not sending
5	M5V (GND_ISO)	Output	Ground isolated
6	P5V (+5V_ISO)	Output	5V isolated
7	T(A)-	Output	Send data (four-wire)
8	R(A)-R(A)-/T(A)-	Input Input/Output	Receive data (four-wire) Receive/Send data (two-wire)
9	n.c.	-	reserved



*Never connect the shield of the cable with GND\_ISO, as this could destroy the interface!*

*GND\_ISO must always be connected on both sides; otherwise the modules could be destroyed!*

**Isolated voltages P5V, M5V**

Pin 6 (P5V) of the isolated interfaces carries the isolated 5V supply with the respective ground GND on pin 5 (M5V). You may use this isolated voltage to provide defined static voltage levels on the signalling lines by means of resistors and ensure that reflections are reduced to a minimum.

**Defined static voltage levels by parameters**

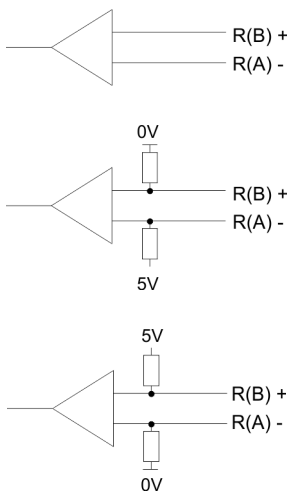

For a connection with minimum reflections and the wire-break recognition at RS422/485 operation, the lines may be preset with defined static voltage levels. At the CP interface the wiring of the receiver is realized as follows:

- None
  - No pre assignment of the receiving lines. This setting only makes sense with bus capable special drivers.
- Signal R(A) 5Volt (Break evaluation)  
Signal R(B) 0Volt
  - With this pre assignment break detection is possible at full-duplex operation (RS422).
- Signal R(A) 0Volt  
Signal R(B) 5Volt
  - This pre assignment corresponds to the idle state (no sender is activated) at half-duplex operation with RS485. Wire-break recognition is not possible, here.











**Power supply**

The CP 341-2CH71 gets its power supply via the SPEED-Bus.

↳ *Chap. 4.3 'Technical data' page 26*



**LEDs** The communication processor is provided with LEDs for the purpose of displaying the operating status. The following table shows the description and the color of these LEDs.

Name	Color	Description
RUN	 green	Blinks at start-up and firmware-update. On at ready for communication.
INTF	 red	On at an internal error of the module. If this error just exists after PowerON, please contact the Yaskawa hotline.
EXTF1	 red	On while wire break at COM1.
FAULT1	 red	On if COM1 is without parameters. Blinks if COM1 has wrong parameters. Flickers on parity error or character frame error at COM1.
TxD1	 green	On if CP is sending user data via COM1.
RxD1	 green	On if CP is receiving user data via COM1.
EXTF2	 red	On while wire break at COM2.
FAULT2	 red	On if COM2 is without parameters. Blinks if COM2 has wrong parameters. Flickers on parity error or character frame error at COM2.
TxD2	 green	On if CP is sending user data via COM2.
RxD2	 green	On if CP is receiving user data via COM2.

**Behavior on firmware update** During firmware update at the corresponding CP the LEDs TxD and RxD are on and the RUN-LED is blinking. The CPU LEDs show the termination of the firmware update.

**Behavior on startup** After PowerON every LED is on for a short time. Then only RUN is blinking. As soon as the CP is ready for communication the RUN LED gets on. As soon as a communication processor is without parameters the corresponding FAULT LED is on.

### 4.3 Technical data

<b>Order no.</b>	<b>341-2CH71</b>
Type	CP 341
SPEED-Bus	✓
<b>Current consumption/power loss</b>	
Current consumption from backplane bus	750 mA
Power loss	3.75 W
<b>Status information, alarms, diagnostics</b>	
Status display	yes
Interrupts	no
Process alarm	no
Diagnostic interrupt	no
Diagnostic functions	yes, parameterizable
Diagnostics information read-out	possible
Supply voltage display	none
Group error display	yes
Channel error display	red LED per channel
<b>Functionality Sub-D interfaces</b>	
Type	X2
Type of interface	RS422/485
Connector	Sub-D, 9-pin, female
Electrically isolated	✓
MPI	-
MP <sup>2</sup> I (MPI/RS232)	-
Point-to-point interface	✓
5V DC Power supply	max. 90mA, isolated
24V DC Power supply	-
<b>Functionality Sub-D interfaces</b>	
Type	X3
Type of interface	RS422/485
Connector	Sub-D, 9-pin, female
Electrically isolated	✓
MPI	-
MP <sup>2</sup> I (MPI/RS232)	-
Point-to-point interface	✓
5V DC Power supply	max. 90mA, isolated
24V DC Power supply	-

<b>Order no.</b>	<b>341-2CH71</b>
<b>Point-to-point communication</b>	
PtP communication	✓
Interface isolated	✓
RS232 interface	-
RS422 interface	✓
RS485 interface	✓
Connector	Sub-D, 9-pin, female
Transmission speed, min.	150 bit/s
Transmission speed, max.	115.2 kbit/s
Cable length, max.	1200 m
<b>Point-to-point protocol</b>	
ASCII protocol	✓
STX/ETX protocol	✓
3964(R) protocol	-
RK512 protocol	-
USS master protocol	-
Modbus master protocol	-
Modbus slave protocol	-
Special protocols	-
<b>Datasizes</b>	
Input bytes	32
Output bytes	32
Parameter bytes	75
Diagnostic bytes	0
<b>Housing</b>	
Material	PPE
Mounting	DIN rail SPEED-Bus
<b>Mechanical data</b>	
Dimensions (WxHxD)	40 mm x 125 mm x 120 mm
Net weight	185 g
Weight including accessories	-
Gross weight	-
<b>Environmental conditions</b>	
Operating temperature	0 °C to 60 °C
Storage temperature	-25 °C to 70 °C
<b>Certifications</b>	

---

Technical data

<b>Order no.</b>	<b>341-2CH71</b>
UL certification	yes
KC certification	-

## 5 Deployment

### 5.1 Fast introduction

#### Overview

The integration of the CP into your SPS system should take place with the following proceeding:

- Assembly and commissioning
- Hardware configuration (integration CP 341-2CH71 in CPU)
- Protocol parameters
- Communication with the user program

#### Assembly and commissioning

1. ➤ Install your SPEED-Bus system with a SPEED7 CPU and a CP 341-2CH71.
2. ➤ Wire-up the system.
  - ↳ *Chap. 3 'Assembly and installation guidelines' page 13*
3. ➤ Switch power ON.
  - ⇒ After a short boot time the CP is in the system without any protocol.
4. ➤ Start the Siemens SIMATIC manager with an online connection to the CPU. More about this may be found in the manual of the CPU.



*For the deployment of the System 300S modules at the SPEED-Bus you have to include the System 300S modules into the hardware catalog via the GSD-file SPEEDBUS.GSD from Yaskawa.*

#### Hardware configuration

1. ➤ Install the SPEEDBUS.GSD from Yaskawa.
2. ➤ For hardware configuration jump within your project to the hardware configurator of the Siemens SIMATIC manager.
3. ➤ Insert a profile rail.
4. ➤ Place the following corresponding Siemens CPU at slot 2 and parameterize the CPU if necessary.
5. ➤ If there are modules at the standard bus right beside the CPU and parameterize the modules if necessary.

The project engineering of the SPEED-Bus modules happens by means of a virtual PROFIBUS DP master system. For this, place as last module a DP master (342-5DA02 V5.0) with master system.

1. ➤ Now include for the CPU and every module at the SPEED-Bus a slave system "VIPA\_SPEEDBUS".
2. ➤ Set as PROFIBUS address the slot no. (100...110) of the module and place the according module from the hardware catalog of VIPA\_SPEEDBUS to slot 0 of the slave system.
3. ➤ In this way place the SPEED-Bus CP 341-2CH71 according to your protocol. In the hardware catalog for each protocol at VIPA\_SPEEDBUS a CP 341-2CH71 is available.

<b>Protocol parameters</b>	Via double-click open the properties of the CP. Here among others the protocol parameters may be preset.
<b>Communication with the user program</b>	<p>For the processing of the connecting jobs at PLC side a user program is necessary in the CPU. Here the Yaskawa specific blocks FB 7 and FB 8 are used for communication between CPU, CP and a communication partner. These blocks are available for download in the service area <a href="http://www.yaskawa.eu.com">www.yaskawa.eu.com</a>.</p> <p>By a cyclic call of these blocks data may be sent and received by the CP. The conversion of the transfer protocols to the communication partner happens at the CP.</p> <p>For each of these FBs an instance DB is necessary. This is to be indicated at the call of the corresponding FB. The data for communication are to be stored in each case in a send respectively receive DB.</p> <p>To control the communication the FBs have control bits. Here the communication may be started, stopped or reset with the appropriate programming for the corresponding CP. There are status bits within the FBs for error evaluation.</p>

## 5.2 Hardware configuration

<b>Preconditions</b>	The hardware configurator is part of the Siemens SIMATIC manager and it serves the project engineering. The modules that may configured here are listed in the hardware catalog. For the deployment of the System 300S modules at the SPEED-Bus you have to include the System 300S modules into the hardware catalog via the GSD-file SPEEDBUS.GSD from Yaskawa.
----------------------	---



*For the project engineering a thorough knowledge of the Siemens SIMATIC manager and the hardware configurator from Siemens is required!*

**Installation of the SPEEDBUS.GSD**

The GSD (Geräte-Stamm-Datei) is online available in the following language versions. Further language versions are available on inquires:

Name	Language
SPEEDBUS.GSD	German (default)
SPEEDBUS.GSG	German
SPEEDBUS.GSE	English

The GSD files may be found at [www.yaskawa.eu.com](http://www.yaskawa.eu.com) at the service area.

The integration of the SPEEDBUS.GSD takes place with the following proceeding:

1. ➤ Go to the service area of [www.yaskawa.eu.com](http://www.yaskawa.eu.com).
2. ➤ Load from the download area at 'Config files → PROFIBUS' the according file for your System 300S.
3. ➤ Extract the file to your work directory.
4. ➤ Start the hardware configurator from Siemens.
5. ➤ Close every project.
6. ➤ Select 'Options → Install new GSD-file'.
7. ➤ Navigate to the directory VIPA\_System\_300S and select **SPEEDBUS.GSD** an.
  - ⇒ The SPEED7 CPUs and modules of the System 300S from Yaskawa may now be found in the hardware catalog at PROFIBUS-DP / Additional field devices / I/O / VIPA\_SPEEDBUS.

**Steps of project engineering**

The following text describes the approach of the project engineering of the CP 341-2CH71 for SPEED-Bus in the hardware configurator from Siemens at an abstract sample. The project engineering is separated into the following parts:

- Project engineering standard bus
- Project engineering SPEED-Bus as virtual PROFIBUS network

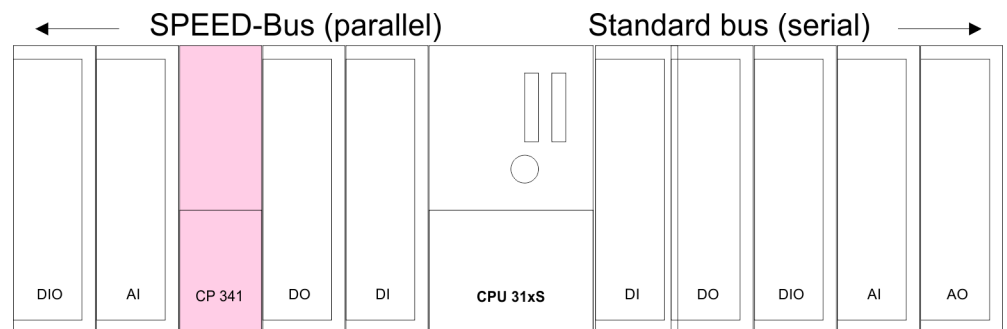

**Project engineering of the modules at the standard bus**

1. ➤ Start the hardware configurator from Siemens with a new project and insert a profile rail from the hardware catalog.
2. ➤ Place in slot 2 the corresponding Siemens CPU.
3. ➤ Parameterize the CPU where appropriate. The parameter window opens by a double click on the according module.

If there are modules at the standard bus right beside the CPU, these are configured with the following approach:

1. ➤ Include your System 300 modules at the standard bus in the plugged sequence starting with slot 4.
2. ➤ Parameterize the modules where appropriate. The parameter window opens by a double click on the according module.
3. ➤ Since as many as 32 modules may be addressed by the SPEED7 CPU in one row, but only 8 modules are supported by the Siemens SIMATIC manager, the IM 360 of the hardware catalog can be used as a virtual bus extension during project engineering. Here 3 further extension racks can be virtually connected via the IM 361. Bus extensions are always placed at slot 3.

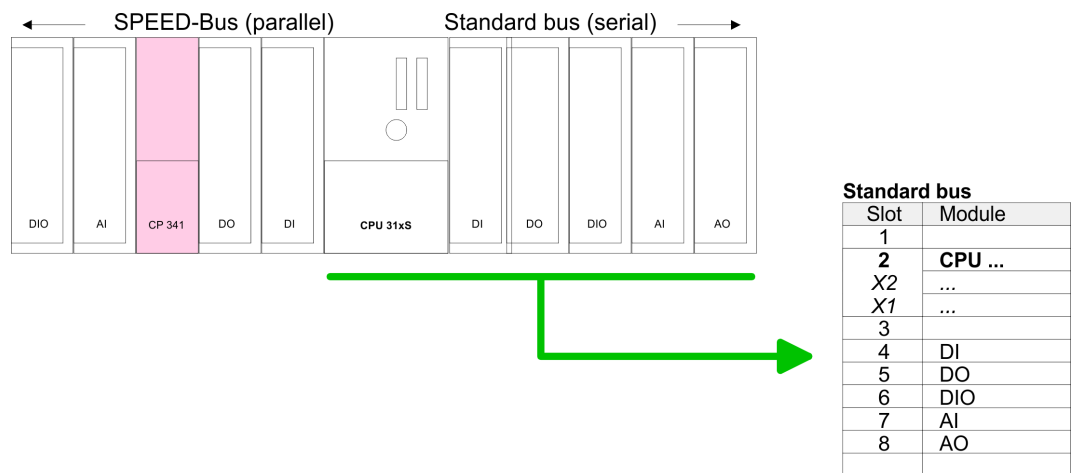

**Project engineering  
SPEED-Bus as virtual  
PROFIBUS network**

The project engineering of the SPEED-Bus modules happens by means of a virtual PROFIBUS DP master system. For this, place as last module a DP master (342-5DA02 V5.0) with master system.

For the deployment of the System 300S modules at the SPEED-Bus the inclusion of the System 300S modules into the hardware catalog via the GSD-file SPEEDBUS.GSD from Yaskawa is required.

After the installation of the SPEEDBUS.GSD you may locate at *PROFIBUS DP / Additional field devices / I/O / VIPA\_SPEEDBUS* the DP slave system VIPA\_SPEEDBUS.

Now include for the CPU and every module at the SPEED-Bus a slave system "VIPA\_SPEEDBUS".

Set as PROFIBUS address the slot no. (100...110) of the module and place the according module from the hardware catalog of VIPA\_SPEEDBUS to slot 0 of the slave system.

In this way place the SPEED-Bus CP 341-2CH71 according to your protocol. In the hardware catalog for each protocol at VIPA\_SPEEDBUS a CP 341-2CH71 is available.



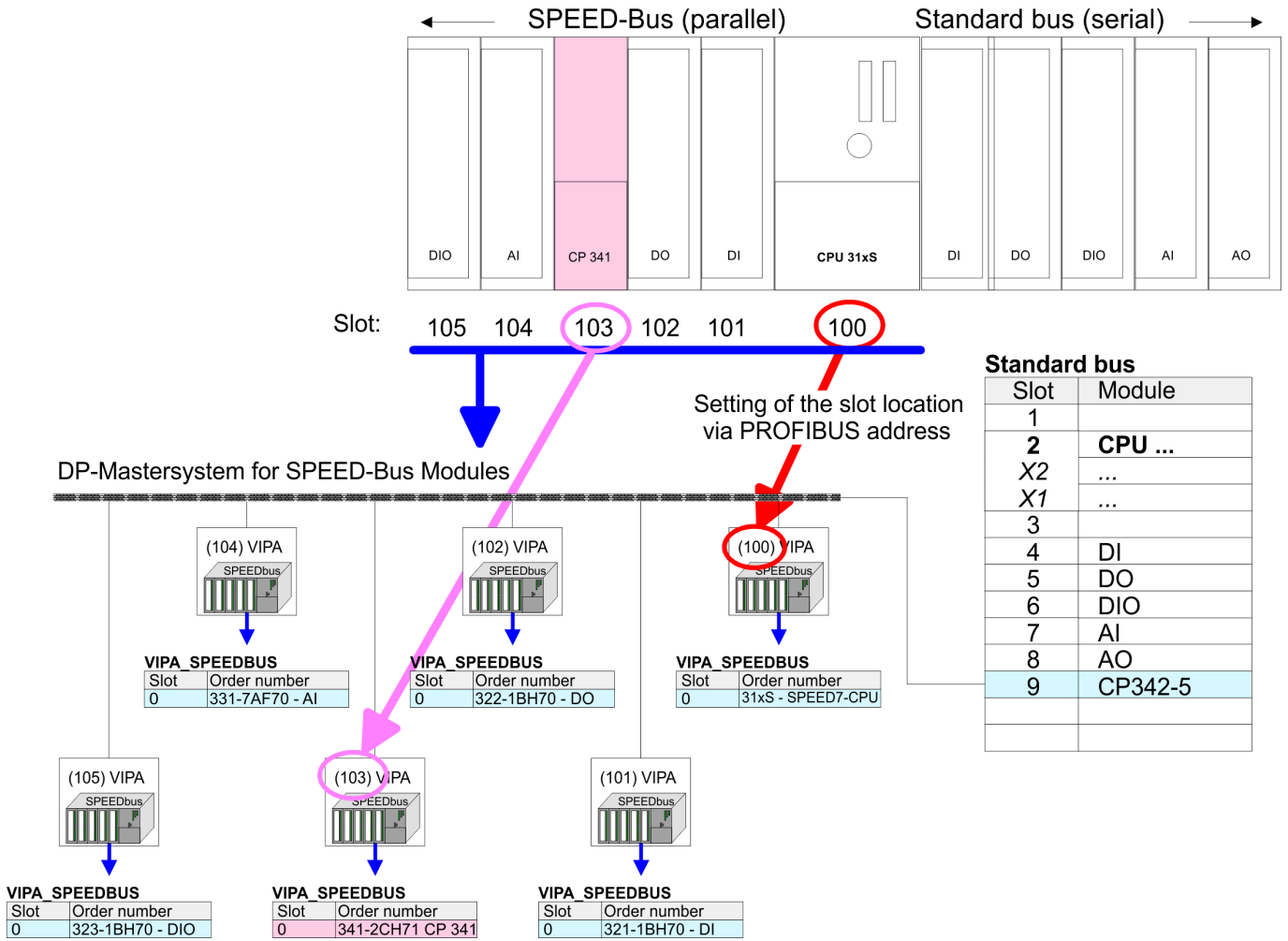

The according module is to be taken over from the hardware catalog of VIPA\_SPEEDBUS to slot 0.

### 5.2.1 Properties CP 341-2CH71

The properties of the CP may be accessed by a double click at the CP, which corresponds to the protocol you want.

Every parameter of the CP may be accessed by the registers *Address/ID* and *Parameter Assignment*.

#### Address/ID

#### Input/Output

- By presetting a start address for the input respectively output area the beginning of the address area of the CPU may be determined, which is mapped by the module. Please regard that the base address for input and output are identical.
- Each interface occupies 16byte. The data of the COM2 interface are allocated with an offset of 16byte.
- The corresponding address value is necessary for integration in the user program. To access the COM2 interface you have to add 16 to the respective address value.

#### Process image

With the process image a consistent image of the process signal may be accessed during the program cycle.

If the field *process image* shows the entry "---" then the set address area is outside the process image. The entry "OB1-PA" indicates that the set address area is within the process image.

#### Parameter Assignment

Here the parameters, which correspond to the protocol, may be preset.

🔗 *Chap. 6 'Communication protocols' page 38*

## 5.3 Communication with the user program

### Overview

For the processing of the connecting jobs at PLC side a user program is necessary in the CPU. Here the following Yaskawa specific blocks are used for communication between CPU, CP and a communication partner:

Block	Symbol	Comment
FB 7	P_RCV_RK	Block for data receipt from a communication partner.
FB 8	P_SND_RK	Block for data send to a communication partner.



*More information about the usage of these blocks may be found in the manual "SPEED7 Operation List" from Yaskawa.*

### Installing blocks

The Yaskawa specific blocks may be found at [www.yaskawa.eu.com](http://www.yaskawa.eu.com) as downloadable library at the service area with Downloads > VIPA LIB.

### Data consistency

The data consistency is limited by the block size of 1024byte during communication between CPU and CP. For the consistent data communication of more than 1024byte the following is to be considered:

- FB 8 - P\_SND\_RK:
  - Access the send DB only again if the data were completely transferred (*DONE* = 1).
- FB 7 - P\_RCV\_RK:
  - Access the receive DB only again if the data were completely received (*NDR* = 1). After that the receive DB should be blocked (*EN\_R* = 0) as long as the data were treated.

**Communication principle**

By a cyclic call of FB 7 and FB 8 data may be cyclic sent and received by the CP. On the CP the transmission of the communication protocols to the communication partner takes place, which may be configured by the hardware configuration.

## 5.4 Firmware update

### Overview

- There is the possibility to execute a firmware update of the CP 341S-2RS422/485 among others via the SPEED7 CPU by means of a memory card.
- So a firmware file may be recognized and assigned with startup, a .pkg file name is reserved for each updateable component and hardware release. This file name begins with "px" and differs in a number with six digits.
- The .pkg file name may be found at a label right down the front flap of the module.

### Latest firmware at [www.yaskawa.eu.com](http://www.yaskawa.eu.com)

The latest firmware versions may be found in the service area at [www.yaskawa.eu.com](http://www.yaskawa.eu.com). For example the following file is necessary for the firmware update of the CP 341-2CH71 with hardware release 01:

- 341-2CH71 hardware release 01: Px000104.pkg



#### CAUTION!

When installing a new firmware you have to be extremely careful. Under certain circumstances you may destroy the CP, for example if the voltage supply is interrupted during transfer or if the firmware file is defective. In this case, please call the Yaskawa-Hotline!

Please regard that the version of the update firmware has to be different from the existing firmware otherwise no update is executed.

### Display the Firmware version of the SPEED7 system via Web Site

- The CPU has an integrated website that monitors information about firmware version of the SPEED7 components. The Ethernet PG/OP channel provides the access to this web site.
- To activate the PG/OP channel you have to enter according IP parameters. This can be made in Siemens SIMATIC manager either by a hardware configuration, loaded by memory card respectively MPI or via Ethernet by means of the MAC address with **PLC > Assign Ethernet Address**.
- After that you may access the PG/OP channel with a web browser via the IP address of the project engineering. More detailed information may be found in the CPU manual at "Access to Ethernet PG/OP channel and webserver".

### Load firmware and transfer it to memory card

1. ➤ Go to [www.yaskawa.eu.com](http://www.yaskawa.eu.com).
2. ➤ Click on Service > Downloads > Firmware.
3. ➤ Click on "Firmware System 300S"
4. ➤ Choose the according CP modules and download the firmware Px000104.pkg.zip to your PC.
5. ➤ Extract the zip-file and copy the extracted file to your memory card. Following this approach, transfer all wanted firmware files to your memory card.



#### CAUTION!

With a firmware update an overall reset is automatically executed. If your program is only available in the load memory of the CPU it is deleted! Save your program before executing a firmware update!

### Transfer firmware from memory card to the CP

1. ➤ Get the RUN-STOP lever of your CPU in position STOP. Turn off the voltage supply. Plug the memory card with the firmware files into the CPU. Please take care of the correct plug-in direction of the memory card. Turn on the voltage supply.
2. ➤ After a short boot-up time, the alternate blinking of the CPU-LEDs SF and FRCE shows that at least a more current firmware file was found on the memory card.
3. ➤ You start the transfer of the firmware to the CP as soon as you tip the RUN/STOP lever downwards to MR within 10s.
4. ➤ During the update process, the CP LEDs RxD, TxD and RUN are on.
5. ➤ The update is successful finished when the LEDs PWR, STOP, SF, FRCE and MCC of the CPU get on. If they are blinking fast, an error has occurred.
6. ➤ Turn Power OFF and ON. Now your CP is ready for operation.



*More about firmware update may be found in the manual of the SPEED7 CPU at chapter "Deployment CPU ..." at "Firmware update".*

## 6 Communication protocols

### 6.1 Overview

#### Serial transfer of a character

The simplest type of information exchange between two stations is the point-to-point link. Here the CP serves for the interface between a host system and a communication partner. The data are serially transferred. During the serial data transfer the individual bits of one byte of an information are transferred after another in a fixed order.

#### Character frame

At bi-directional data transfer it is differentiated between *full-duplex* and half-duplex operation. At *half-duplex* operation at one time data may be sent or received. A simultaneous data exchange is only possible at *full-duplex* operation. Each character to be transferred is preceded by a synchronizing pulse as *start bit*. The end of the transferred character is formed by the *stop bit*. Beside the start and stop bit there are further parameterizable agreements between the communication partners necessary for serial data transfer.

This character frame consists of the following elements:

- Transfer speed (Baud rate)
- Character and acknowledgement delay time
- Parity
- Number of data bits
- Number of stop bits

#### Protocols

The CP serves for an automatic serial data transfer. To do this the CP is equipped with a driver for the corresponding protocols.

The following protocols are described:

- ASCII
- STX/ETX

## 6.2 ASCII

### 6.2.1 Basics ASCII

#### Mode of operation

ASCII data communication is a simple kind of data exchange that may be compared to a multicast/broadcast function. Individual telegrams are separated by means of character delay time (ZVZ). Within this time the transmitter must have sent its telegram to the receiver. A telegram is only passed on to the host system if this was received completely. The receiving station must acknowledge the receipt of the telegram within the "time delay after command" (ZNA) or command window that was defined in the sending station. These time stamps may be used to establish a simple serial communication link. Since during ASCII transmission apart from the usage of the parity bit no further step takes place for data protection, the data transfer is very efficient however not secured. With the parity the inversion of one bit within a character may be secured. If two or more bits of a character are inverted, this error may no longer be detected.

### 6.2.2 Proceeding

For the deployment of the ASCII protocol you have to add to your master system a SPEED-Bus slave and to configure a CP 341-2CH71 (ASCII) as described at "Hardware configuration".

🔗 *Chap. 5.2 'Hardware configuration' page 30*

The properties dialog of the CP may be opened by a double-click. Every parameter of the ASCII protocol may be accessed via the register *Parameter Assignment with Device-specific parameters*. Related to the interface the interface number COM1 respectively COM2 is put in front of the parameter designation.

### 6.2.3 ASCII parameters

#### Baud rate

Here the transfer speed in bit/s may be selected from a selection list.

**Range of values: 150 ... 115200**

- Default: 9600

#### Protocol

Leave this value preset to "ASCII". If "No protocol" is set, the interface is deactivated and on a send job you will get an according error message.

**Range of values: No protocol, ASCII**

- Default: ASCII

#### Data bits

Number of bits onto which a character is mapped.

**Range of values: 5 ... 8**

- Default: 8

#### Parity

The addition of its value "0" or "1" brings the value of all the bits (data bits and parity bit) up to a defined status.

**Range of values: none, odd, even**

- Default: none

#### Stop bit

When data is transmitted, stop bits are appended to each character to be sent in order to signal the end of a character.

**Range of values: 1, 2**

- Default: 1

**Flux control**

Data flux control synchronizes data transmission when one communication partner works faster than the other. Here the type of data flux control may be set.

Value	Description
none	The flux control is deactivated.
hardware	<i>Hardware</i> flux control employs the RTS and CTS lines and these must therefore be wired accordingly.
XON/XOFF	<i>Software</i> flux control employs the control characters XON=11h and XOFF=13h.  Please remember that your data must not contain these control characters!

**Range of values: none, hardware, XON/XOFF**

- Default: none

**Time after order**

- The delay time that must expire before a command is executed.
- The *Time after order* is to be specified in ms.

**Range of values: 0 ... 65535**

- Default: 0

**Character delay time**

- The *Character delay time* defines the maximum time that may expire between two characters of a single message during the reception of the message.
- The *Character delay time* is to be specified in ms.
- When the *Character delay time* = 0 the character delay time will be calculated automatically (about double character time).

**Range of values: 0 ... 65535**

- Default: 200

**Number receive buffers**

Defines the number of receive buffers. When only 1 receive buffer is available no more data may be received while the receive buffer is occupied. The received data may be redirected into an unused receive buffer when you chain up to a maximum of 250 receive buffers.

**Range of values: 1 ... 250**

- Default: 1



**Setting of receive channel**

For a connection with minimum reflections and the break evaluation at RS422/485 operation, the lines may be preset with defined static voltage levels. At the CP interface the wiring of the receiver is realized as follows:

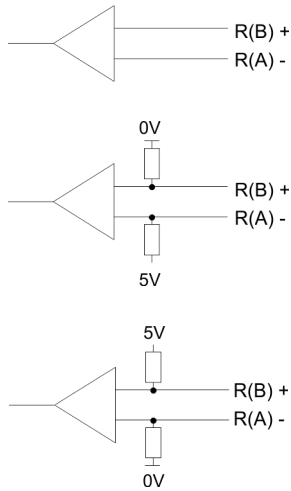

- None
  - No pre assignment of the receiving lines. This setting only makes sense with bus-capable special drivers.
- Signal R(A) 5Volt (Break evaluation)  
Signal R(B) 0Volt
  - With this pre assignment break detection is possible at full-duplex operation (RS422).
- Signal R(A) 0Volt  
Signal R(B) 5Volt
  - This pre assignment corresponds to the idle state (no sender is activated) at half-duplex operation with RS485. Wire-break recognition is not possible, here.

**Range of values: None, R(A) 5Volt R(B) 0Volt, R(A) 0Volt R(B) 5Volt**

- Default: None

**Operating mode**

Via the operating mode you may specify if the interface is operated in *half-* (RS485) or *full-duplex* (RS422) operation.



*At half-duplex parameterization with RS485 software data flow control is not possible.*

Value	Description
Full-duplex	<ul style="list-style-type: none"> <li>■ Four-wire operation (RS422)                             <ul style="list-style-type: none"> <li>– Data is exchanged between the communication partners in both directions simultaneously. In full-duplex operation, therefore, data may be sent and received at the same time. Each communication partner must be able to operate a send and a receive facility simultaneously.</li> </ul> </li> </ul>
Half-duplex	<ul style="list-style-type: none"> <li>■ Two-wire operation (RS485)                             <ul style="list-style-type: none"> <li>– Data is exchanged between the communication partners but only in one direction at a time. In half-duplex operation, therefore, at any one time data is being either sent or received.</li> </ul> </li> </ul>

**Range of values: Full-duplex, Half-duplex**

- Default: Full-duplex

## 6.3 STX/ETX

### 6.3.1 Basics STX/ETX

#### Mode of operation

STX/ETX is a simple protocol employing header and trailer. The STX/ETX procedure is suitable for the transfer of ASCII characters (20h...7Fh). It does not use block checks. Any data transferred from the periphery must be preceded by an STX (Start of Text) followed by the data characters. An ETX (End of Text) must be inserted as the terminating character. The effective data, which includes all the characters between STX and ETX, are transferred to the host system when the ETX has been received. When data is sent any user data is handed to the CP where it is enclosed with an STX start character and an ETX termination character and transferred to the communication partner.

#### Telegram structure

You may define up to 2 start and end characters. It is also possible to specify a ZNA for the sending station.

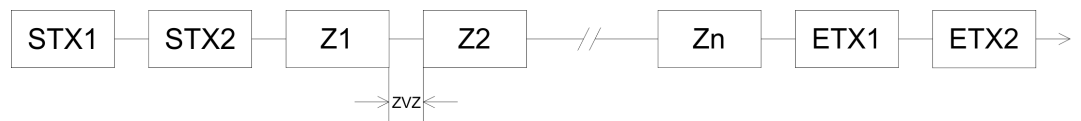

### 6.3.2 Proceeding

For the deployment of the STX/ETX protocol you have to add to your master system a SPEED-Bus slave and to configure a CP 341-2CH71 (STX/ETX)

🔗 *Chap. 5.2 'Hardware configuration' page 30*

The properties dialog of the CP may be opened by a double-click. Every parameter of the STX/ETX protocol may be accessed via the register Parameter Assignment with Device-specific parameters. Related to the interface the interface number COM1 respectively COM2 is put in front of the parameter designation.

### 6.3.3 STX/ETX parameters

#### Transmission rate

Here the transfer speed in bit/s may be selected from a selection list.

**Range of values: 150 ... 115200**

- Default: 9600

#### Protocol

Leave this value preset to "STX/ETX". If "No protocol" is set, the interface is deactivated and on a send job you will get an according error message.

**Range of values: No protocol, STX/ETX**

- Default: STX/ETX

#### Data bits

Number of bits onto which a character is mapped.

**Range of values: 5 ... 8**

- Default: 8

#### Parity

The addition of its value "0" or "1" brings the value of all the bits (data bits and parity bit) up to a defined status.

**Range of values: none, odd, even**

- Default: none

**Stop bit** When data is transmitted, stop bits are appended to each character to be sent in order to signal the end of a character.

**Range of values: 1, 2**

- Default: 1

**Flux control** Data flux control synchronizes data transmission when one communication partner works faster than the other. Here the type of data flux control may be set.

Value	Description
none	The flux control is deactivated.
hardware	<i>Hardware</i> flux control employs the RTS and CTS lines and these must therefore be wired accordingly.
XON/XOFF	<i>Software</i> flux control employs the control characters XON=11h and XOFF=13h. Please remember that your data must not contain these control characters!

**Range of values: none, hardware, XON/XOFF**

- Default: none

**Time after order (ZNA)** The delay time that must expire before a command is executed. The ZNA is to be specified in ms.

**Range of values: 0 ... 65535**

- Default: 0

**Timeout (TMO)** TMO defines the maximum time between two messages. TMO is to be specified in ms.

**Range of values: 0 ... 65535**

- Default: 200

**Number start identifications** You may select 1 or 2 start identifications. When you select "1" as *number of start identifications*, the contents of the 2. start identification is ignored.

**Range of values: 0 ... 2**

- Default: 2

**Start identification 1 and 2** The ASCII value of the start character that precedes a message to signify the start of a data transfer. You may select 1 or 2 start characters. When you are using 2 start characters you have to specify "2" at *Number of start identifications*.

**Range of values: 0 ... 255**

- Default:
  - Start identification 1: 0
  - Start identification 2: 0

**Number end identifications**

You may select 1 or 2 end identifications. When you select "1" as number of end identifications, the contents of the 2. end identification is ignored.

**Range of values: 0 ... 2**

- Default: 1

**End identification 1 and 2**

The ASCII value of the end character that follows a message to signify the end of the data transfer. You may specify 1 or 2 end characters. When you are using 2 end characters you have to enter a "2" at *Number of end flags*.

**Range of values: 0 ... 255**

- Default:
  - End flag 1: 3
  - End flag 2: 0

**Setting of receive channel**

For a connection with minimum reflections and the break evaluation at RS422/485 operation, the lines may be preset with defined static voltage levels. At the CP interface the wiring of the receiver is realized as follows:

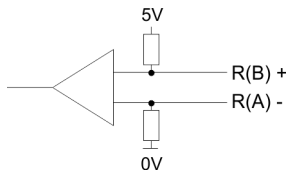
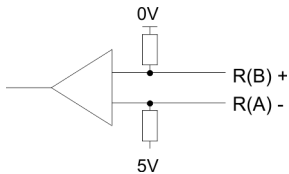
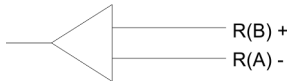

- none
  - No pre assignment of the receiving lines. This setting only makes sense with bus capable special drivers.
- Signal R(A) 5Volt (Break evaluation)  
Signal R(B) 0Volt
  - With this pre assignment break detection is possible at full-duplex operation (RS422).
- Signal R(A) 0Volt  
Signal R(B) 5Volt
  - This pre assignment corresponds to the idle state (no sender is activated) at half-duplex operation with RS485. Wire-break recognition is not possible, here.

**Range of values: none, R(A) 5Volt R(B) 0Volt, R(A) 0Volt R(B) 5Volt**

- Default: none

**Operating mode**

Via the operating mode you may specify if the interface is operated in *half-duplex* (RS485) or *full-duplex* (RS422) operation.

Value	Description
full-duplex	<ul style="list-style-type: none"> <li>■ Four-wire operation (RS422)                             <ul style="list-style-type: none"> <li>– Data is exchanged between the communication partners in both directions simultaneously. In full-duplex operation, therefore, data may be sent and received at the same time. Each communication partner must be able to operate a send and a receive facility simultaneously.</li> </ul> </li> </ul>
half-duplex	<ul style="list-style-type: none"> <li>■ Two-wire operation (RS485)                             <ul style="list-style-type: none"> <li>– Data is exchanged between the communication partners but only in one direction at a time. In half-duplex operation, therefore, at any one time data is being either sent or received.</li> </ul> </li> </ul>

**Range of values: full-duplex, half-duplex**

- Default: full-duplex

## 7 Accessing diagnostics messages

### 7.1 Accessing diagnostics messages

#### Overview

The diagnostics functions enable you to quickly localize any errors, which occur. The following diagnostics options are available:

- Diagnostics via the CP-LEDs
- Diagnostics via diagnostic buffer of the corresponding CP

#### Diagnostics via CP-LEDs

The CP-LEDs give you an initial overview of any internal or external error as well as interface-specific errors.

🔗 *'LEDs' page 25*

#### Diagnosis via diagnostic buffer of the CP

Each CP part has its own diagnostic buffer. There every diagnostic event of the CP is stored in the order, in which they occur. The diagnostic buffer is a ring buffer for a maximum of 100 diagnostic entries. When the diagnostic buffer is full, the oldest entry is deleted when a new entry is recorded. This means that the most recent entry is always the first.

#### Access to the diagnostics buffer

The diagnostics buffer of the corresponding CP may be accessed by means of the handling block SFC 59 RD\_REC "Read record" with the record set 80 for COM1 respectively record set 81 for COM2.

Here every CP part responses with a record set of 200byte.



*More information about the usage of this block may be found in the manual "SPEED7 Operation List" from Yaskawa.*

#### Error messages

The following errors may be reported:

- Hardware respectively firmware errors
- Initialization and parameterization errors
- Errors during execution of a CPU request
- Data transmission error (send and receive errors)



*The contents of the diagnostic buffer is lost in the event of a PowerOFF.*

## 7.2 Diagnostic messages

**Structure** Each diagnostics message has a length of 2byte and the following structure:



0000h indicates no diagnostics entry is available.

**Event classes and event numbers** The table below describes the various event classes and numbers:

Event class 00h "CP start-up"	
Event class / number	Description
00 03h	PtP parameter accepted
00 04h	Parameter already on CP (timers match)
00 07h	Status transition CPU to STOP
00 08h	Status transition CPU to RUN/START-UP
Event class 01h "Hardware fault on CP"	
01 01h	Fault while testing operating system EPROM of CP <i>Remedy: CP defective and must be replaced.</i>
01 02h	RAM test of CP faulty <i>Remedy: CP defective and must be replaced.</i>
01 03h	Request interface of CP defective <i>Remedy: CP defective and must be replaced.</i>
01 10h	Fault in CP firmware <i>Remedy: Switch CP off and on again. If necessary, replace CP.</i>
Event class 02h "Initialization error"	
02 0Fh	Invalid parameterization detected at start of parameterized communication. Interface could not be parameterized. <i>Remedy: Correct the non-permissible parameterization and initialize a start-up.</i>
Event class 03h "Error parameterization of FBs"	
(not displayed in diagnostic buffer)	
03 01h	<ul style="list-style-type: none"> <li>■ Invalid or no source/destination data type</li> <li>■ Invalid area (start address, length)</li> <li>■ DB invalid or no DB (e.g. DB 0) or</li> <li>■ other data type invalid or missing.</li> </ul> <i>Remedy: Check parameterization on CPU and CP and correct if necessary.</i>
Event class 04h "CP detected error in data traffic CP - CPU"	
04 03h	Incorrect, unknown or illegal data type (e.g. wrong parameterization of FB) <i>Remedy: Check program for incorrect parameterization of the FB.</i>

04 07h	<p>Error during data transmission between CPU and CP.</p> <p><i>Remedy: If fault indication persists, check whether function blocks you have called in user program are parameterized correctly.</i></p> <p><i>If error is indicated immediately after PowerON, no connection has yet been set up to the CPU. In the case of the ASCII driver, the receiving CP re-attempts data transfer until the data is transmitted to the CPU.</i></p> <p><i>If fault indication is sporadic in the course of data transfer, the CPU is temporarily unable to accept data. In the case of the ASCII driver the receiving CP re-attempts data transfer until the data is transmitted to the CPU.</i></p>
04 08h	<p>Error during data transmission between CPU and CP (reception).</p> <ul style="list-style-type: none"> <li>■ CPU is temporarily overloaded, request queued for repetition.</li> </ul> <p><i>Remedy: Reduce number of communication calls</i></p> <ul style="list-style-type: none"> <li>■ CPU data area temporarily unavailable for access, for example because receive block is called too infrequently.</li> </ul> <p><i>Remedy: Call the receive block more frequently.</i></p> <ul style="list-style-type: none"> <li>■ CPU data area temporarily unavailable for access, for example because receive block is temporarily locked (EN = false).</li> </ul> <p><i>Remedy: Check whether the receive block is disabled for too long.</i></p>
<b>... Event class 04h "CP detected error in data traffic CP - CPU"</b>	
04 09h	<p>Data cannot be received. Error during data transmission between CPU and CP (reception). Request is canceled in 10s following multiple attempts, because:</p> <ul style="list-style-type: none"> <li>■ Receive block is not called</li> </ul> <p><i>Remedy: Check whether your user program runs the receive block.</i></p> <ul style="list-style-type: none"> <li>■ Receive block is disabled</li> </ul> <p><i>Remedy: Check whether the receive block is disabled.</i></p> <ul style="list-style-type: none"> <li>■ Access to CPU data area denied</li> </ul> <p><i>Remedy: check that the data area to which the data is to be transferred is available.</i></p> <ul style="list-style-type: none"> <li>■ CPU data area too short.</li> </ul> <p><i>Remedy: Check the length of the data area.</i></p>
04 0Ah	<p>Error during data transmission between CPU and CP. Data transfer canceled by RESET because:</p> <ul style="list-style-type: none"> <li>■ Destination DB is not available</li> <li>■ Destination DB is too short</li> <li>■ RESET bit set at FB.</li> </ul> <p><i>Remedy: Create destination DB in the user program or increase the length of the existing destination DB, as applicable.</i></p>
<b>Event class 05h "error while processing CPU request"</b>	
05 00h	<ul style="list-style-type: none"> <li>■ The length of a received message frame was longer than the length agreed upon.</li> </ul> <p><i>Remedy: a correction is necessary at the partner.</i></p> <ul style="list-style-type: none"> <li>■ The length of the parameterized input buffer is too short.</li> </ul> <p><i>Remedy: the length of the input buffer must be enlarged.</i></p>

Diagnostic messages

05 01h	<p>Current request aborted as a result of CP restart.</p> <p><i>Remedy: No remedy is possible at PowerON. When re-parameterization of the CP from the programming device, before writing an interface you should ensure there are no more request running from the CPU.</i></p>
05 02h	<p>Request not permitted in this operating mode of CP (e.g. device interface not parameterized).</p> <p><i>Remedy: Parameterize the device interface.</i></p>
05 14h	<p>Specified start addresses too high for desired data type, or start address or DB/DX number too low.</p> <p><i>Remedy: Obtain from the request tables the permissible start addresses and DB/DX numbers that can be specified in the program.</i></p>
05 17h	<p>Transmission length &gt; 1kbyte too great for CP or too short for interface parameter.</p> <p><i>Remedy: Split the request up into several shorter requests.</i></p>
<b>Event class 07h "Send error"</b>	
07 08h	<p>The waiting time for XON respectively CTS = ON has elapsed.</p> <p><i>Remedy: The communication partner has a fault, is too slow or is switched off-line. Check the communication partner or, if necessary, change the parameterization.</i></p>
<b>Event class 08h "Receive error"</b>	
08 0Ah	<p>There is no free input buffer available.</p> <p><i>Remedy: The FB P_RCV_RK must be called more frequently.</i></p>
08 0Bh	<p>Internal input buffer is full.</p> <p><i>Remedy: The FB P_RCV_RK must be called more frequently.</i></p>
08 0Ch	<p>Transmission error</p> <ul style="list-style-type: none"> <li>■ Transmission error (parity error-, stop bit error or overflow error) detected.</li> </ul> <p><i>Remedy: Disturbances on the transmission line cause message frame repetitions, thus lowering user data throughput. Danger of an undetected error increase. Correct fault by changing system setup or line installation. Check connecting cable of communications partner or check whether both devices have same setting for baud rate, parity and number of stop bits.</i></p>
08 0Dh	<p>BREAK</p> <ul style="list-style-type: none"> <li>■ Receive line to partner is interrupted.</li> </ul> <p><i>Remedy: reconnect or switch partner on again. Check and change the connector pin assignment of the 2-wire receiving line R(A), R(B).</i></p>
<b>... Event class 08h "Receive error"</b>	
08 10h	<p>Parity error</p> <p><i>Remedy: Check the connecting cables of the communication partners or check whether both devices have the same setting for baud rate, parity and number of stop bits.</i></p>
08 11h	<p>Character frame error</p> <p><i>Remedy: Check the connecting cables of the communication partners or check whether both devices have the same setting for baud rate, parity and number of stop bits. Change your system setup or cable wiring.</i></p>
08 15h	<p>Discrepancy between settings for transfer attempts at CP a communication partner.</p> <p><i>Remedy: Parameterize same number of transfer attempts at communication partner as at CP. Check for malfunction at partner device, possible by using interface test device switched into the transmission line.</i></p>



08 16h	<ul style="list-style-type: none"><li>■ The length of a received message frame was longer than the length agreed upon. <i>Remedy: a correction is necessary at the partner.</i></li><li>■ The length of the parameterized input buffer is too short. <i>Remedy: the length of the input buffer must be enlarged.</i></li></ul>
<b>Event class 30 (1Eh) "Error during communication between CP and CPU via backplane bus"</b>	
1E 0Dh	Request aborted due to complete Restart or Reset.