

HMI

PPC | 67S-RRJ0 | Manual

HB160 | PPC | 67S-RRJ0 | en | 23-11

Panel PC - PPC021 EC



YASKAWA Europe GmbH
Philipp-Reis-Str. 6
65795 Hattersheim
Germany
Tel.: +49 6196 569-300
Fax: +49 6196 569-398
Email: info@yaskawa.eu
Internet: www.yaskawa.eu.com

Table of contents

1	General	5
1.1	Copyright © YASKAWA Europe GmbH	5
1.2	About this manual	6
1.3	Safety information	6
2	Hardware description	8
2.1	Safety information for users	8
2.2	Properties	9
2.3	Structure	10
2.3.1	Overview	10
2.3.2	Interfaces	12
2.3.3	Memory management	16
2.4	Dimensions	17
2.5	General data	18
2.6	Use in difficult operating conditions	19
2.7	Technical data	19
3	Deployment Panel PC	22
3.1	Installation	22
3.2	Installation of the CFast card	23
3.3	Commissioning	24
3.3.1	Firmware update	24
3.3.2	Startup-Manager	25
3.4	Connection to a PLC system	28
3.5	Operating system Windows Embedded Compact 7	29
3.5.1	General	29
3.5.2	Structure	30
3.6	Integrated server	32
3.6.1	General	32
3.6.2	ftp server	33
3.6.3	Telnet server	34
3.6.4	VNC server	35
3.7	Access to the network resources	37
4	BIOS setup	38
4.1	Overview	38
4.2	Main	39
4.3	Advanced	40
4.4	Chipset	50
4.5	Boot	55
4.6	Security	56
4.7	Save and Exit	58

5	Industrial Security and Installation guidelines.	59
5.1	Industrial security in information technology.	59
5.1.1	Protection of hardware and applications.	60
5.1.2	Protection of PC-based software.	61
5.2	Installation guidelines.	61
5.2.1	Basic rules for the EMC-equitable assembly of installations.	61
5.2.2	EMC-equitable assembly.	64
5.2.3	EMC-equitable cabling.	65
5.2.4	Special precautions providing high noise immunity.	68
5.2.5	Checklist for the EMC-compliant installation of controllers.	69

1 General

1.1 Copyright © YASKAWA Europe GmbH

All Rights Reserved	<p>This document contains proprietary information of Yaskawa and is not to be disclosed or used except in accordance with applicable agreements.</p> <p>This material is protected by copyright laws. It may not be reproduced, distributed, or altered in any fashion by any entity (either internal or external to Yaskawa) except in accordance with applicable agreements, contracts or licensing, without the express written consent of Yaskawa and the business management owner of the material.</p> <p>For permission to reproduce or distribute, please contact: YASKAWA Europe GmbH, European Headquarters, Philipp-Reis-Str. 6, 65795 Hattersheim, Germany</p> <p>Tel.: +49 6196 569 300 Fax.: +49 6196 569 398 Email: info@yaskawa.eu Internet: www.yaskawa.eu.com</p>
EU conformity declaration	<p>Hereby, YASKAWA Europe GmbH declares that the products and systems are in compliance with the essential requirements and other relevant provisions. Conformity is indicated by the CE marking affixed to the product.</p>
Conformity Information	<p>For more information regarding CE marking and Declaration of Conformity (DoC), please contact your local representative of YASKAWA Europe GmbH.</p>
Trademarks	<p>All Microsoft Windows, Office and Server products mentioned are registered trademarks of Microsoft Inc., USA.</p> <p>All other trademarks, logos and service or product marks specified herein are owned by their respective companies.</p>
General terms of use	<p>Every effort has been made to ensure that the information contained in this document was complete and accurate at the time of publishing. We cannot guarantee that the information is free of errors, and we reserve the right to change the information at any time. There is no obligation to inform the customer about any changes. The customer is requested to actively keep his documents up to date. The customer is always responsible for the deployment of the products with the associated documentation, taking into account the applicable directives and standards.</p> <p>This documentation describes all hardware and software units and functions known today. It is possible that units are described that do not exist at the customer. The exact scope of delivery is described in the respective purchase contract.</p>
Document support	<p>Contact your local representative of YASKAWA Europe GmbH if you have errors or questions regarding the content of this document. You can reach YASKAWA Europe GmbH via the following contact:</p> <p>Email: Documentation.HER@yaskawa.eu</p>
Technical support	<p>Contact your local representative of YASKAWA Europe GmbH if you encounter problems or have questions regarding the product. If such a location is not available, you can reach the Yaskawa customer service via the following contact:</p> <p>YASKAWA Europe GmbH, European Headquarters, Philipp-Reis-Str. 6, 65795 Hattersheim, Germany Tel.: +49 6196 569 500 (hotline) Email: support@yaskawa.eu</p>

1.2 About this manual

Objective and contents

This manual describes the Panel PC 67S-RRJ0-....

- It describes the structure, configuration and application.
- The manual is written for users with basic knowledge of automation technology.
- The manual consists of chapters. Each chapter describes a completed topic.
- The following guides are available in the manual:
 - An overall table of contents at the beginning of the manual.
 - References with pages numbers.

Validity of the documentation

Product	Order number	as of version:		
PPC021 EC	67S-RRJ0-...	HW: 01	FW: V1.0.0	Windows® Embedded Compact 7

Icons and headings

Important passages in the text are highlighted by following icons and headings:



DANGER

Immediate or likely danger. Personal injury is possible.



CAUTION

Damages to property is likely if these warnings are not heeded.



Supplementary information and useful tips.

1.3 Safety information

Applications conforming with specifications

The system is constructed and produced for:

- communication and process control
- general control and automation tasks
- industrial applications
- operation within the environmental conditions specified in the technical data
- installation into a cubicle



DANGER

This device is not certified for applications in

- in explosive environments (EX-zone)

Disposal

National rules and regulations apply to the disposal of the unit!

Documentation

The manual must be available to all personnel in the:

- project design department
- installation department
- commissioning
- operation

**CAUTION**

The following conditions must be met before using or commissioning the components described in this manual:

- Hardware modifications to the process control system should only be carried out when the system has been disconnected from power!
- Installation and hardware modifications only by properly trained personnel.
- The national rules and regulations of the respective country must be satisfied (installation, safety, EMC ...)

2 Hardware description

2.1 Safety information for users

Handling of electrostatic sensitive modules

The modules make use of highly integrated components in MOS-Technology. These components are extremely sensitive to over-voltages that can occur during electrostatic discharges. The following symbol is attached to modules that can be destroyed by electrostatic discharges.



The Symbol is located on the module, the module rack or on packing material and it indicates the presence of electrostatic sensitive equipment. It is possible that electrostatic sensitive equipment is destroyed by energies and voltages that are far less than the human threshold of perception. These voltages can occur where persons do not discharge themselves before handling electrostatic sensitive modules and they can damage components thereby, causing the module to become inoperable or unusable. Modules that have been damaged by electrostatic discharges can fail after a temperature change, mechanical shock or changes in the electrical load. Only the consequent implementation of protection devices and meticulous attention to the applicable rules and regulations for handling the respective equipment can prevent failures of electrostatic sensitive modules.

Shipping of modules

Modules must be shipped in the original packing material.

Measurements and alterations on electrostatic sensitive modules

When you are conducting measurements on electrostatic sensitive modules you should take the following precautions:

- Floating instruments must be discharged before use.
- Instruments must be grounded.

Modifying electrostatic sensitive modules you should only use soldering irons with grounded tips.



CAUTION

Personnel and instruments should be grounded when working on electrostatic sensitive modules.

2.2 Properties

General

The Panel PC is a combination of industrial PC with state of the art performance features and a touch panel with ideal display capabilities. The Panel PC is a compact and modular embedded PC based on Windows® Embedded Compact 7 - WEC7. Besides the extensive WEC7 functions the Panel PC offers varied communication possibilities.



- Windows® Embedded Compact 7
- Movicon 11 CE Standard
- 21.5" 16:9 TFT panel 16.7 M color
- PCAP, multitouch
- Display resolution 1920 x 1080
- Processor: Baytrail Intel® Celeron J1900, Quad core 2GHz
- Work memory: 2x 204Pin DDR3 SO-DIMM Socket, 2GB DDR3
- User memory: 2GB SATA DOM
- CFAST slot
- 2 RS232/RS422/RS485 (switchable), 3 USB-A, 2 Ethernet interfaces, VGA port and Audio out, connector for remote Power switch
- Metal case
- Passive cooling
- Easy mounting via integrated pivoted lever
- Protection class IP66 (frontal)

Order data

Type	Order number	Description
PPC021 EC	67S-RRJ0-...	21.5" TFT color, 2x RS232/RS422/RS485, 3x USB-A, 2x Ethernet RJ45, VGA, Audio out

Structure > Overview

2.3 Structure

2.3.1 Overview

Front view

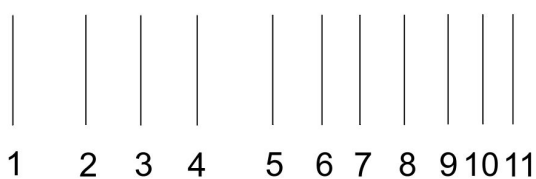
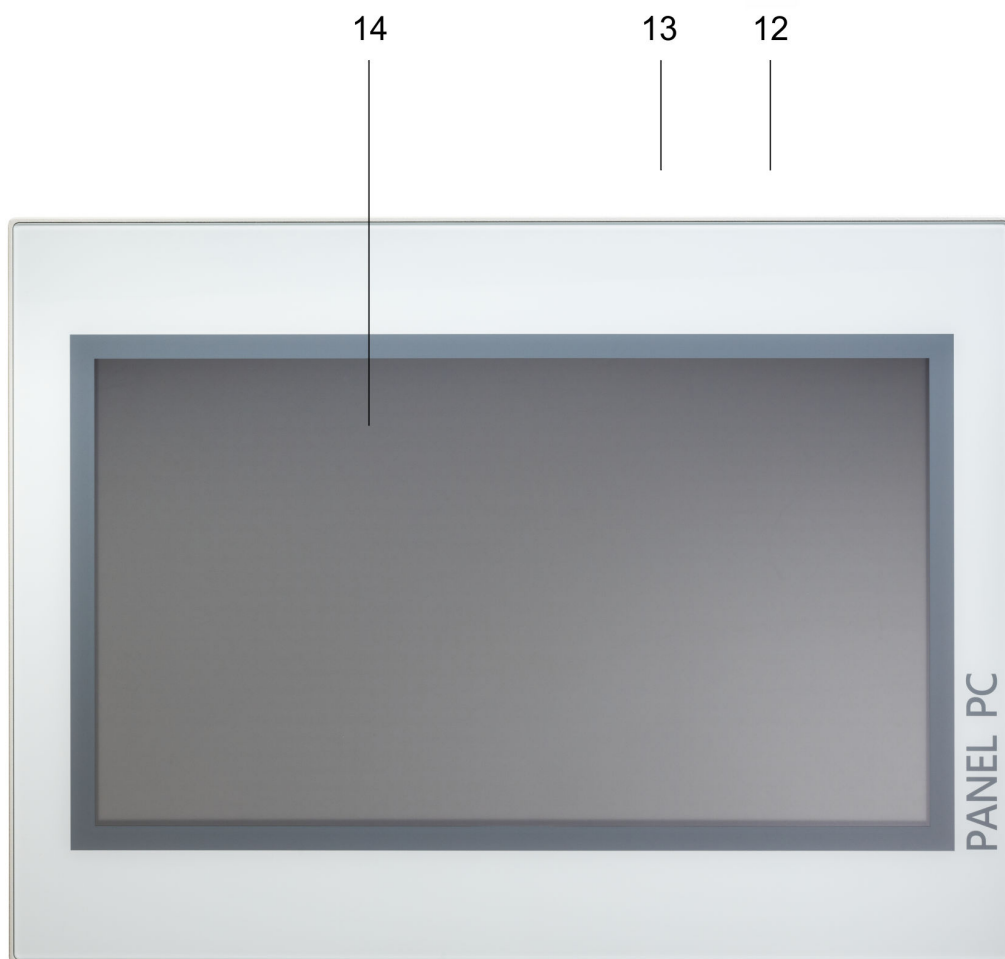

- 1 Slot for voltage supply (DC 12-30V)
- 2 VGA interface
- 3 Reset button
- 4 RS232/RS422/RS485 interface COM 2
- 5 RS232/RS422/RS485 interface COM 1
- 6 USB-A interface USB 3.0
- 7 2x USB-A interface USB 2.0
- 8 RJ45 jack for Ethernet communication LAN 2
- 9 RJ45 jack for Ethernet communication LAN 1
- 10 2 pin connector for remote Power switch
- 11 3.5mm Audio Line out
- 12 Power switch (pushbutton)
- 13 Slot for CFast storage media
- 14 Display with touch sensitive area (touch screen)

Bottom view

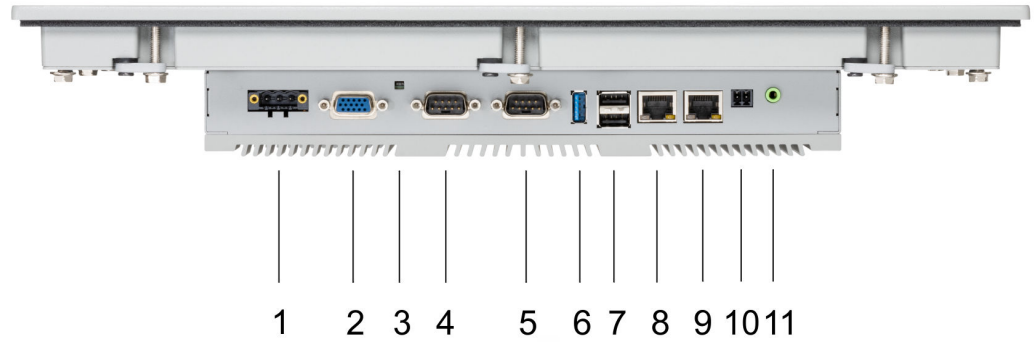

- 1 Slot for voltage supply (DC 12-30V)
- 2 VGA interface
- 3 Reset button
- 4 RS232/RS422/RS485 interface COM 2
- 5 RS232/RS422/RS485 interface COM 1
- 6 USB-A interface USB 3.0
- 7 2x USB-A interface USB 2.0
- 8 RJ45 jack for Ethernet communication LAN 2
- 9 RJ45 jack for Ethernet communication LAN 1
- 10 2 pin connector for remote Power switch
- 11 3.5mm Audio Line out



Please make sure that the Panel PC always has to be supplied with external voltage!

Top view



- 1 Slot for CFast storage media
- 2 Power switch (pushbutton)



The Panel PC starts automatically when the power supply is switched on. It may be switched off by the power switch.

But you can change the configuration in the BIOS setup so that the Panel PC has to be switched on by the power switch. → ['Restore AC Power Loss' ...page 51](#)

2.3.2 Interfaces

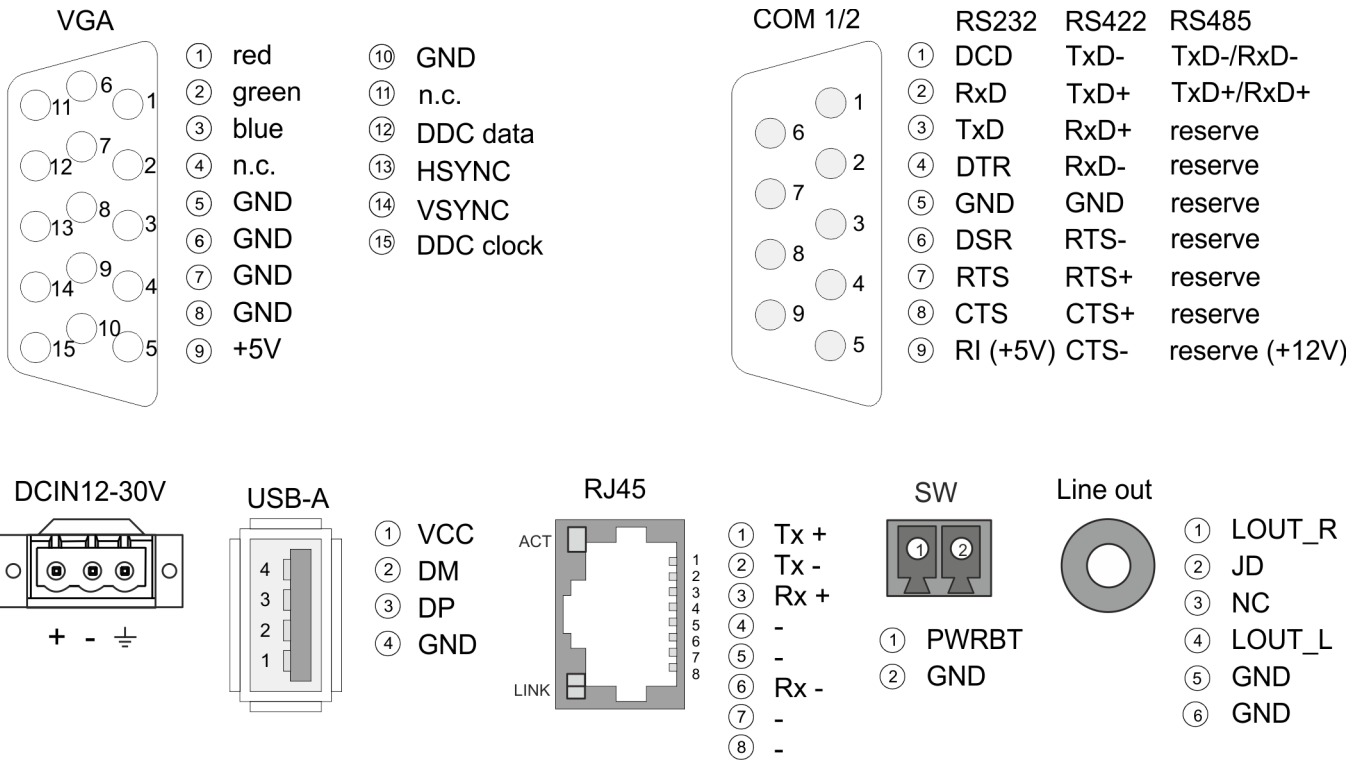

Power supply

The Panel PC has got an integrated power supply. The power supply has to be provided with DC 12... 30V. For this you find an according DC 24V slot at the back. The power supply is protected against inverse polarity and overcurrent. The matching 3-pin plug connector is included in the scope of delivery.

VGA interface

VGA SubD HD15 jack to connect a second display.

RS232/RS422/RS485 interface (switchable)

The 9-pin male SubD connector may be switched with BIOS. Here also the termination resistor of the RS422 and RS485 interface may be activated or deactivated. → [‘Submenu “Serial Port 2 Configuration” ...page 44](#)

RS232 interface

- Logical conditions as voltage level
- Point-to-point connection with serial full-duplex transfer
- Data transfer up to a distance of 15m
- Data transfer rate up to 115.2kbit/s

RS422 interface

- Logical conditions as voltage difference between 2 twisted lines
- Serial bus connection full-duplex four-wire operation
- Line length: 250m at 115.2kbit/s ... 1200m at 19.2kbit/s
- Data transfer rate up to 115.2kbit/s

RS485 interface

- Logical conditions as voltage difference between 2 twisted lines
- Serial bus connection half-duplex two-wire operation
- Line length: 250m at 115.2kbit/s ... 1200m at 19.2kbit/s
- Data transfer rate up to 115.2kbit/s

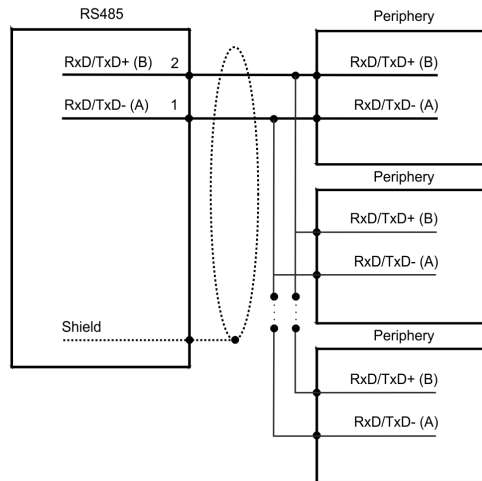
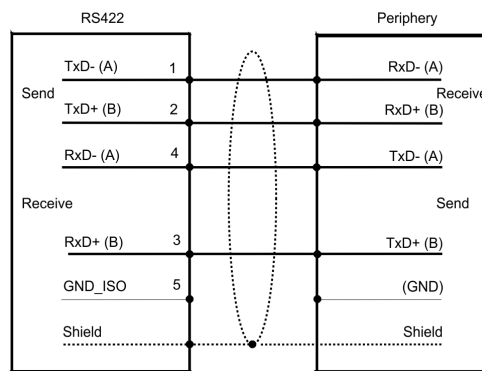
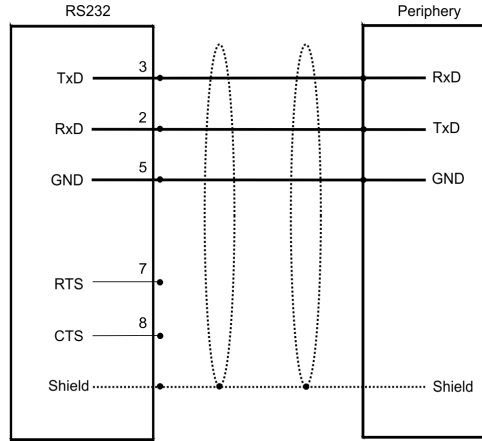















"Host"-USB-A

The Panel PC has a USB 3.0 and two USB 2.0 interfaces. The fast USB 3.0 interface can be recognized by the blue connector. USB 2.0 works half-duplex, the data can only be transmitted in one direction. USB 3.0 works full-duplex, meaning that data can be transferred simultaneously in both directions. Using the "Host"-USB-A interfaces USB mouse, keyboard, stick or USB hard discs can be connected.

Ethernet connection

The two RJ45 jacks provide the interface to the twisted pair cable, required for Ethernet.

LEDs

Activity	Link	Link	Description
 yellow	 green	 orange	
 blinks			1000Mbit/s link
 blinks			100Mbit/s link
 blinks			10Mbit/s link or no link
			not active

Remote Power switch connection (SW)

At this connection, you can connect an additional pushbutton as a remote Power switch to switch the PPC on or off from any location. The matching 2-pin plug connector is included in the scope of delivery. [↪ further information ...page 11](#)

Line out

3.5 mm stereo jack to connect an active speaker system or an earphone.

2.3.3 Memory management

Overview

- 2GB work memory
- 2GB SATA DOM user memory
- USB storage media using "Host"-USB-A interface
- Slot for CFast memory card

Work memory

The Panel PC has a work memory with a size of 2GB. The work memory is not buffered and is deleted after shut down.

User memory

As internal permanent storage medium the Panel PC has a 2GB flash module (1600Mbyte for user data). After the start of Windows® this memory is listed as *Flashdisk* under *My Device*.

USB storage media

The Panel PC has got three USB-A interfaces (1x USB 3.0 and 2x USB 2.0). The connection of USB sticks and USB drives are supported by the Panel PC.

Slot for CFast

At the back of the Panel PC there is a card slot for a memory card. At this slot you can plug storage modules of the type CFast 2.0 - 600 MB/s (6Gbit/s) - SATA protocol - not hot-swap compatible.

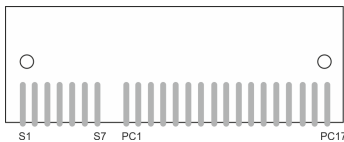

Pin	Assignment	Pin	Assignment
S1	GND	PC6	n.c.
S2	SATA_TX1+	PC7	GND
S3	SATA_TX1-	PC8	CFAST_LED1_C
S4	GND	PC9	CFAST_LED2_C
S5	SATA_RX1+	PC10	n.c.
S6	SATA_RX1-	PC11	n.c.
S7	GND	PC12	n.c.
PC1	CFAST_CDI	PC13	VCC3
PC2	GND	PC14	VCC3
PC3	n.c.	PC15	GND
PC4	n.c.	PC16	GND
PC5	n.c.	PC17	CFAST_CDO



Prior to removing the CFast card, make sure the unit's power is off and disconnected from the power supply.

2.4 Dimensions

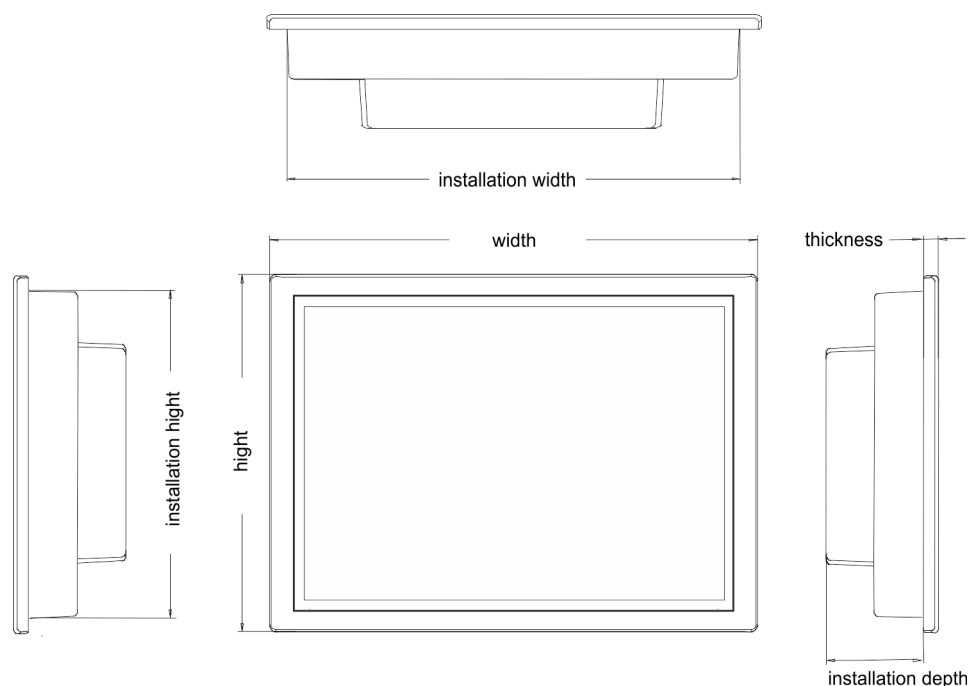

Installation dimensions

For the installation of the Panel PC in control cabinets and desks the following dimensions are necessary:

21.5" - 67S-RRJ0-...

Front panel thickness	3 ... 12mm
Installation cutting (W x H)	547 x 367mm
Front panel (W x H x T)	562.4 x 382.4 x 6.7mm
Rear panel (W x H x D)	542 x 362 x 54.2mm
Installation depth	54.2mm



The degrees of protection are only guaranteed when the following is observed:

- *The material thickness of the installation cut-out is 3 ... 12mm*
- *The deviation from the plane for the panel cut-out is $\leq 0.5\text{mm}$*
- *Permissible surface roughness in the area of the seal: $\leq 120\mu\text{m}$ (friction coefficient 120)*

General data

2.5 General data

Conformity and approval		
Conformity		
CE	2014/30/EU	EMC directive
Approval		
UL		Refer to Technical Data
others		
RoHS	2011/65/EU	Restriction of the use of certain hazardous substances in electrical and electronic equipment
Protection of persons and device protection		
Type of protection	-	IP20
Electrical isolation		
to the field bus	-	electrically isolated
to the process level	-	electrically isolated
Insulation resistance		-
Insulation voltage to reference earth		
Inputs / outputs	-	AC / DC 50V, test voltage AC 500V
Protective measures	-	against short circuit
Environmental conditions to EN 61131-2		
Climatic		
Storage / transport	EN 60068-2-14	-20...+75°C
Operation		
Horizontal installation	EN 61131-2	-10...+60°C
Vertical installation	EN 61131-2	-10...+60°C
Air humidity	EN 60068-2-30	RH1 (without condensation, rel. humidity 10...95%)
Pollution	EN 61131-2	Degree of pollution 2
Mechanical		
Oscillation	EN 60068-2-6	1g, 9Hz ... 150Hz
Shock	EN 60068-2-27	15g, 11ms
Mounting conditions		
Mounting place	-	In the control cabinet
Mounting position	-	Horizontal and vertical

EMC	Standard	Comment	
Emitted interference	EN 61000-6-4	Class A (Industrial area)	
Noise immunity zone B	EN 61000-6-2	Industrial area	
		EN 61000-4-2	ESD 8kV at air discharge (degree of severity 3), 4kV at contact discharge (degree of severity 2)
		EN 61000-4-3	HF field immunity (casing) 80MHz ... 1000MHz, 10V/m, 80% AM (1kHz) 1.4GHz ... 2.0GHz, 3V/m, 80% AM (1kHz) 2GHz ... 2.7GHz, 1V/m, 80% AM (1kHz)
		EN 61000-4-6	HF conducted 150kHz ... 80MHz, 10V, 80% AM (1kHz)
		EN 61000-4-4	Burst, degree of severity 3
	EN 61000-4-5	Surge, degree of severity 3 ¹	

1) Due to the high-energetic single pulses with Surge an appropriate external protective circuit with lightning protection elements like conductors for lightning and overvoltage is necessary.

2.6 Use in difficult operating conditions



Without additional protective measures, the products must not be used in locations with difficult operating conditions; e.g. due to:

- dust generation
- chemically active substances (corrosive vapors or gases)
- strong electric or magnetic fields

2.7 Technical data

Order no.	67S-RRJ0-EB
Type	Panel PC PPC021 CE
Display	
Display size (diagonal)	21.5 "
Display size (width)	478 mm
Display size (height)	269 mm
Resolution	1080 x 1920 / 1920 x 1080
Aspect ratio	16:9
Type of display	TFT color (16.7M colors)
MTBF Backlights (25°C)	50000 h
System properties	
Processor	Intel Celeron Quad core 2 GHz
Operating system	Windows Embedded Compact 7
User software	Movicon 11 CE Standard

Technical data

Order no.	67S-RRJ0-EB
Work memory	2 GB
User memory	2 GB
Available memory (user data)	1600 MB
SD/MMC Slot	-
CF Card Slot Typ II	-
CFast Slot	✓
Time	
Real-time clock buffered	✓
Clock buffered period (min.)	4 y
Type of buffering	lithium battery
Load time for 50% buffering period	-
Load time for 100% buffering period	-
Accuracy (max. deviation per day)	10 s
Operating controls	
Touchscreen	PCAP
Touch function	Dual Touch
Keyboard	external via USB
Mouse	external via USB
Interfaces	
MPI, PROFIBUS-DP	-
MPI, PROFIBUS-DP connector	-
Serial, COM1	RS232 / RS422 / RS485
COM1 connector	Sub-D, 9-pin, male
Serial, COM2	RS232 / RS422 / RS485
COM2 connector	Sub-D, 9-pin, male
Number of USB-A interfaces	3
USB-A connector	USB-A (host)
Number of USB-B interfaces	-
USB-B connector	-
Number of ethernet interfaces	2
Ethernet	Ethernet 10/100/1000 MBit
Ethernet connector	2 x RJ45
Integrated ethernet switch	-
Video connectors	VGA SubD HD15
Audio connections	Line out, stereo jack 3.5 mm
Technical data power supply	
Power supply (rated value)	DC 24 V
Power supply (permitted range)	DC 20.4...28.8 V

Order no.	67S-RRJ0-EB
Reverse polarity protection	✓
Current consumption (no-load operation)	1.2 A
Current consumption (rated value)	1.3 A
Inrush current	1.3 A
I^2t	0.35 A ² s
Power loss	32 W
Status information, alarms, diagnostics	
Status display	none
Supply voltage display	none
Mechanical data	
Housing / Protection class	
Material	coated aluminium steel plate
Mounting	via integrated pivoted lever
Protection class IP front side	IP 66
Protection class IP back side	IP 20
Protection class NEMA front side	-
Protection class NEMA back side	-
Dimensions	
Front panel	562.4 mm x 382.4 mm x 6.7 mm
Rear panel	542 mm x 362 mm x 54.2 mm
Installation cut-out	
Width	547 mm
Height	367 mm
Minimum	3 mm
Maximum front panel thickness	12 mm
Net weight	9.1 kg
Weight including accessories	-
Gross weight	-
Environmental conditions	
Operating temperature	-10 °C to 60 °C
Storage temperature	-20 °C to 75 °C
Certifications	
UL certification	yes
KC certification	-

3 Deployment Panel PC

3.1 Installation

Overview

The Panel PC is suitable for the installation in operating tables and control cabinet fronts. The installation happens via the back. The Panel PC is provided with a fixing technique with not losable screws that allows an easy connection with a crosstip screwdriver. A fast and easy device change is possible. It is also possible to install the Panel PC in a VESA holder (VESA 75/100).

Installation cutting

For the installation into a operating tableau and control cabinet fronts, the Panel PC requires the following front panel cutting:

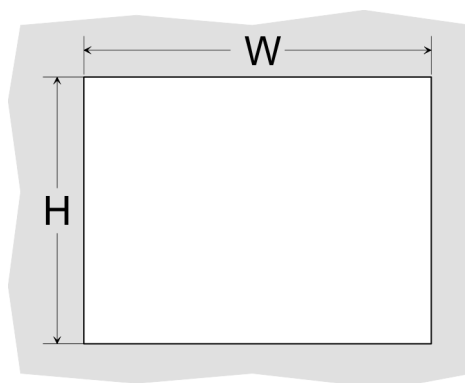

Panel PC	W x H in mm
67S-RRJ0-...	547 x 367mm



The material thickness of the installation cut-out is 3 ... 12mm.

Installation

For the installation of the panel pivoted lever are integrated. For the installation, a crosstip screwdriver is required.

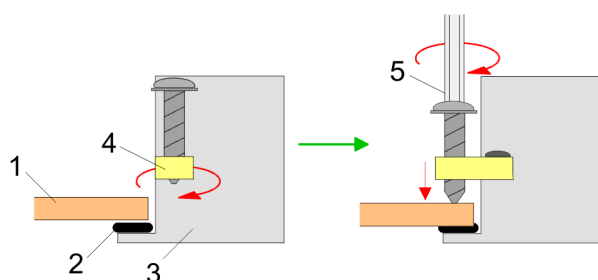

1. → Push the Panel PC [3] from the front side into the front panel cutting [1] until it touches the panel with the seal [2].
2. → Rotate the pivoted lever 90 degrees to the outside [4].
3. → Screw the screws with the crosstip screwdriver [5].

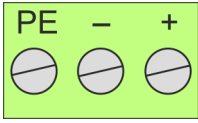
Connect power supply

For the cabling of the power supply DC 12-30V a green plug is used. The connector is a plug with screw contacts. The plug has the following assignment:

- + DC 24V
- DC 0V
- PE Protective earth

3.2 Installation of the CFast card**Installation**

The CFast card slot is located on the rear top side of the Panel PC. It is closed with a cover plate.



1. → Remove the cover plate of the slot by removing the screws and pulling the plate.



2. → With the label facing up, insert the CFast card until it is completely seated in the slot and reinstall the cover plate.

→ After installation the CFast card is automatically recognized.

**Demounting**

1. → Remove the screws.
2. → Pull the holding plate from the card slot.
3. → Push the CFast card to remove the card.
4. → Reinstall the cover plate.

**CAUTION**

Prior to removing the CFast card, make sure the unit's power is off and disconnected from the power supply.

3.3 Commissioning

**CAUTION**

- Before commissioning the device must be brought to room temperature.
- At condensation the device must be absolutely dry before connected to power.
- Avoid using in direct sunlight.
- After opening the control cabinet or desk, there are parts with possible dangerous voltage available.
- For all signal connections only screened cables are permitted.
- Signal cables must not be let within the same cable shaft as high voltage cables.

**CAUTION**

When changing the '*Regional Settings*', please note that only *English* and *German* are supported, other languages can lead to a system crash.

3.3.1 Firmware update

Firmware update without Startup Manager

To execute the firmware update an external keyboard and an USB stick (memory size 4GB) is necessary. The new image file for your Panel PC should be on the USB stick. You will find the file and a detailed description of the firmware update on www.yaskawa.eu.com in the Download Center under 67S-RRJ0-....

Firmware update with Startup Manager

In the "Startup Manager", run the Firmware update of your Panel PCs via the [Info/Update] button.

3.3.2 Startup-Manager

Start screen

As soon as the Panel PC is provided by power supply, the *Startup-Manager* will be loaded. At the first startup of the *Startup-Manager* the following *start screen* appears.

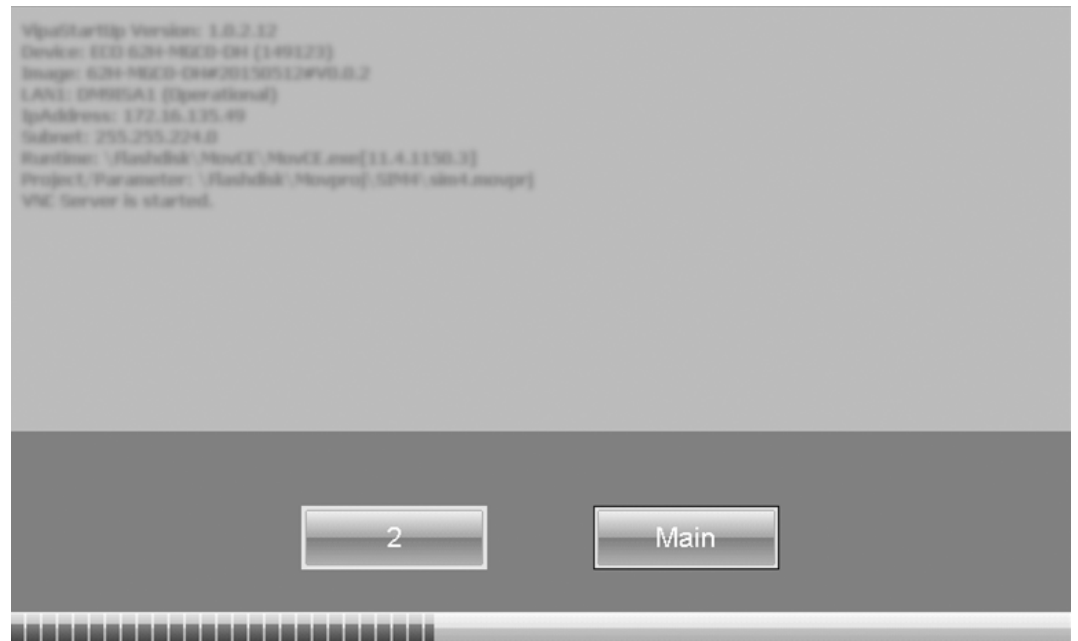

- There is a button on the *initial screen* with a counter, which counts backwards. If you click on this button within this time, the project will start. If the time expires, the project will start automatically. With the button 'Main' you get to the 'selection menu'.
- A delay time of 5 seconds is default. In the *selection menu* under "Autostart" you can adjust this time.

Selection menu

There are following buttons in the *selection menu*:

- Settings
- Info/Update
- Autostart
- Backup
- Exit
- Back

Settings

In [Settings] under *Change Settings* you can set a password for the Startup-Manager. The password will be requested when interrupting the start countdown. By default, no password is defined. In [Settings] the system settings can be set exactly like via Windows 'Start → Settings → Control Panel'.

Info/Update (firmware)

- To execute the firmware update press the button [Info/Update]. After clicking [Info/Update] the current image is displayed under '*Image Version*' with panel name, creation date and version number. With [Create Screenshot] you can make a screen shot of the panel information and select a destination for its storage.
- To execute the firmware update an external keyboard and an USB stick (memory size 4 GB) is necessary. The new image file for your Panel PC should be on the USB stick. You will find the file and a detailed description of the firmware update on www.yaskawa.eu.com in the Download Center under 67S-RRJ0-....

Autostart

With [Autostart] you define which runtime and which project will be started automatically together with the panel startup.

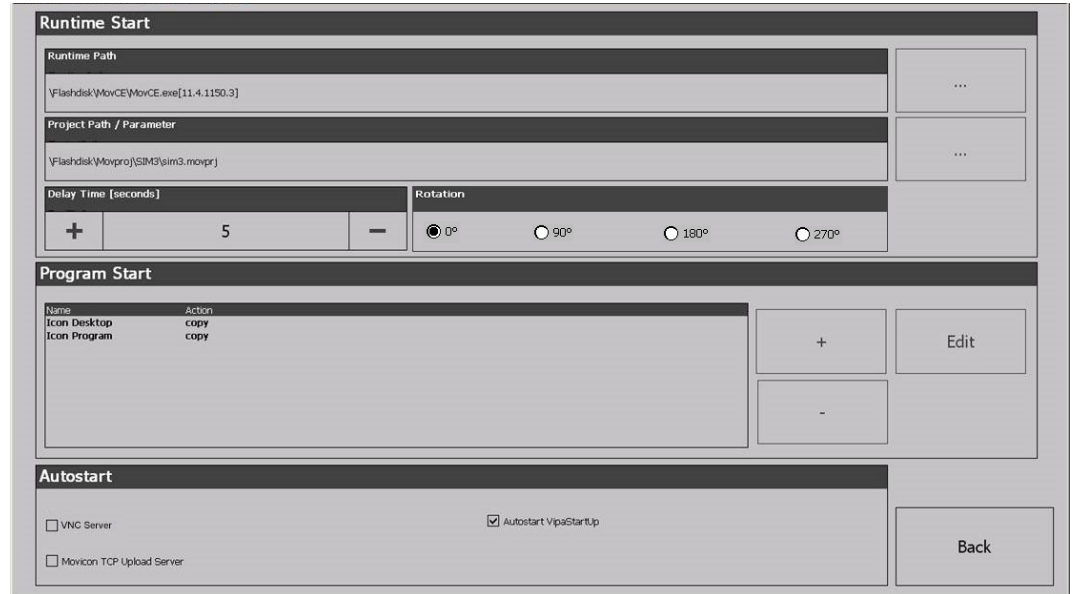

- With [...] at 'Runtime path' res. 'Project path' all existing runtimes res. projects on the panel and the storage media will be listed.
- Under 'Delay Time' you can adjust a delay time > 0 by using the buttons [+] and [-]. 5 seconds are default.
- Via "Program start" with [+] you can add programmes, which have to start automatically.
- Via "Rotation" the orientation of the panel can be changed.

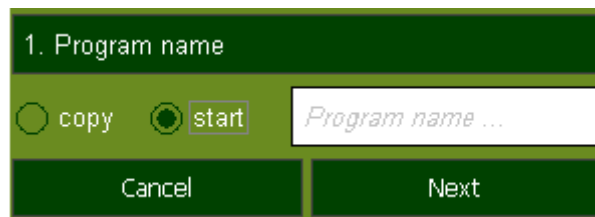

1. Select "start" and assign a name for the program.

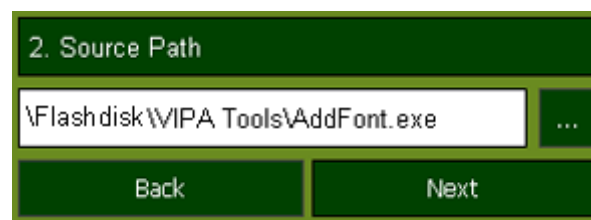

2. Upload your program with [...].

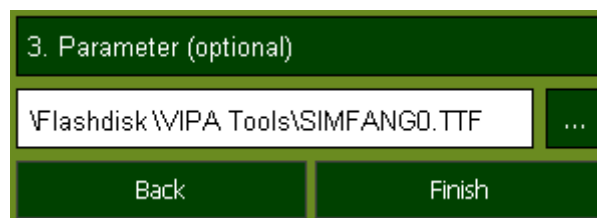

3. You can optionally set parameters.

4. Exit with [Finish].

- With 'Copy' [...] files can be copied on the panel from a source path to a destination path.
- With 'Autostart' you can select the automatic startup of the VNC Server, the Movicon-TCP upload server und the Startup-Manager. With [back] you can return to the *select menu*.

Backup

By default, the configuration of the Startup-Manager, the registry settings for the backlight, the local settings and the LAN settings will be saved by [Backup] in 'Flashdisk → Backup'. The name of the backup file is "backup.bkv". Which settings will be saved and the storage location are defined in the file "ToDoList.xml" under 'Flashdisk → VipaStartup'. These can be adjusted accordingly.

Exit

The Startup-Manager will be closed by [Exit] and the system returns to the Windows® screen.

Back

With [Back] you get back to the start screen of the Startup-Manager.

3.4 Connection to a PLC system

Overview

- For the inclusion into your PLC system several HMI/SCADA project-engineering platforms are at your disposal that has to be installed on an external PC. Here you can create your project, where appropriate simulate it and transfer it to the Panel PC via a connection that you've entered before. Via the on the Panel PC pre-installed runtime version of the HMI/SCADA project engineering platforms your project is run able.
- By using the according communication driver, the Panel PC supports connecting options to the PLC via Ethernet.
- During operation your operating device communicates with the according PLC and reacts to the application courses in the PLC according to the configured processes. Via dialogues configured before, process values can be monitored graphically, altered and evaluated.

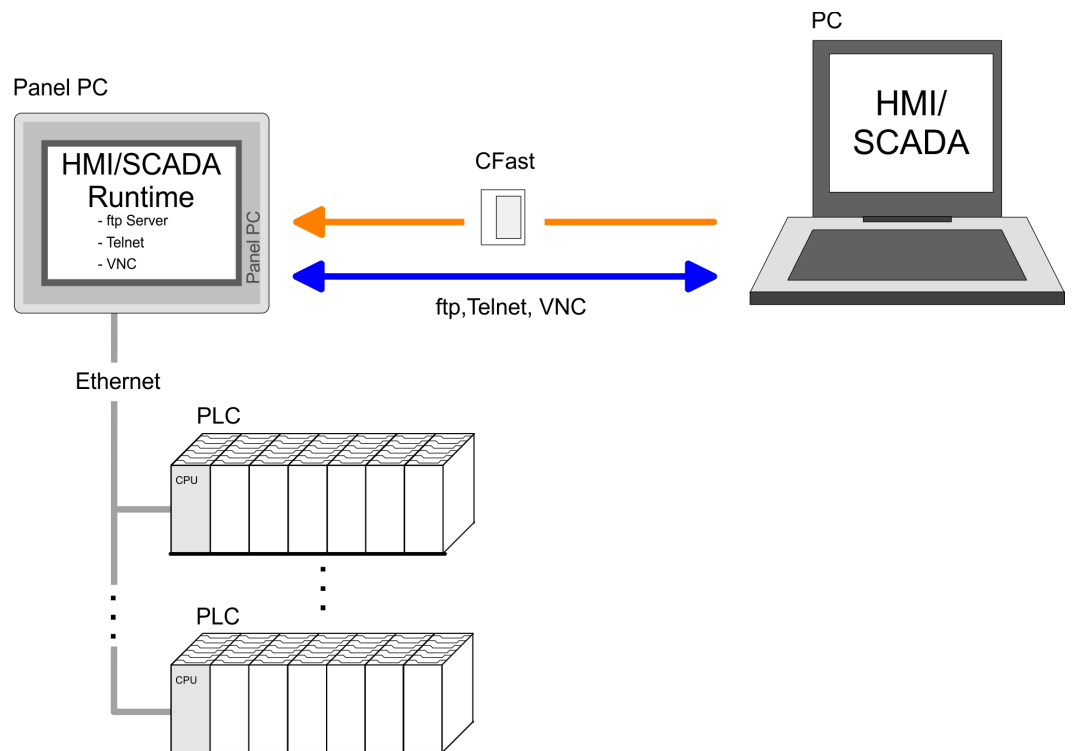

3.5 Operating system Windows Embedded Compact 7

3.5.1 General

Windows® Embedded Compact 7 - WEC7 is the next generation of Windows CE operating systems designed for innovative and small-footprint devices.

Features

- File viewer for Word, Excel, PowerPoint and PDF
- ftp, Telnet and VNC server
- RDP (Remote Desktop Protocol)
- Internet Explorer
- Registry Editor
- WordPad
- USB keyboard driver
- Startup-Manager

Differences to the standard Windows® operation

Please regard that for the deployment of WEC7 a thorough knowledge of operating Windows® are assumed. Here are only shown the differences to a "standard" Windows® operating system.

Pen entry

You're operating the Panel by means of a pencil for capacitive touch screen res. with the finger. The following types of entry are differentiated:

- *Double click*
A double click has to be executed like mouse operation by touching the area on the screen twice. A double click on an object opens res. executes this.
- *Drag*
By tapping on an object and then dragging you can move the object on the screen. If no object is selected, a frame is created by the dragging that selects the touched objects.

Navigation within the dialog window

The windows can be moved via the head bar. Here you can also find the [OK] button to confirm entries and the [X] button for exiting the dialog.

Exit WEC7 (shut down)

You can not exit WEC7. By switching the power supply off and on again you can restart WEC7. Before a reboot you should always save your data res. close all running applications to avoid data loss.

Manual storage

For manual storage please use the "Store" tool via 'Start → Programs → Tools → System Tools'.

Soft reset

To reboot the operating system (soft reset) please use the "Soft-Reset" tool via 'Start → Programs → Tools → System Tools'.

3.5.2 Structure

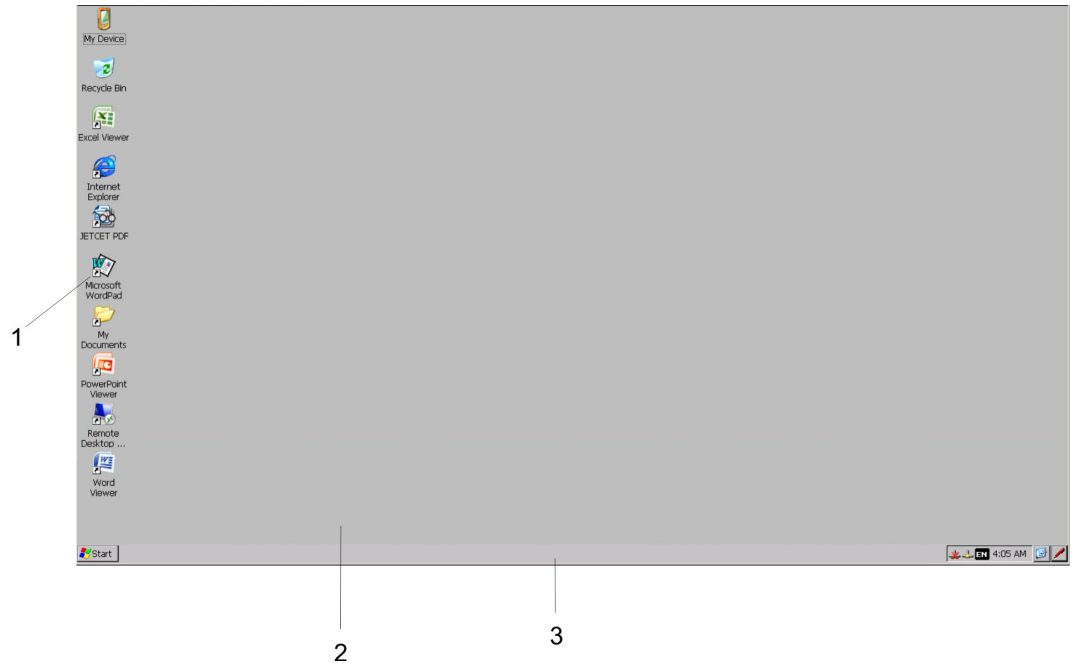

1	<i>Icon</i>	Via icons on the desktop you gain direct access to the application related to the icon.
2	<i>Desktop</i>	The desktop is the screen that is shown after login to Windows ®. It contains e.g. links to the mostly used applications res. system components.
3	<i>Task bar</i>	The task bar is part of the desktop. When opening an application, a document or a window, every running object is displayed as button on the task bar. Via this buttons you can easily change between the open windows.

Task bar

Basically the taskbar has the following structure:



1	<i>Start button</i>	This button offers you access to all components of your Panel PC such as applications, system settings, file browser etc.
2	<i>Open applications</i>	For every open application a button can be found in the task bar. There is no button for minimizing. The switch between the applications is performed via this buttons.
3	<i>Network connection</i>	As soon as your Panel PC is connected via Ethernet you can see here the Ethernet address. If there is no connection via Ethernet, the symbol is displayed crossed out.
4	<i>Keyboard layout</i>	If you've connected a keyboard you can choose the requested language layout via this button.
5	<i>Time</i>	This area shows the time that you can change via double click.
6	<i>Show desktop</i>	All windows are minimized and the desktop is shown.
7	<i>Software keyboard</i>	This button displays a keyboard at the screen. "Hide Input Panel" hides the keyboard again.

Software keyboard

The button  allows you to select one of the available software keyboards. At the moment the following standard keyboards are implemented:

Large Keyboard

Input Panel															
Esc	F1	F2	F3	F4	F5	F6	F7	F8	F9	F10	F11	F12	Home	End	Prop
`	1	2	3	4	5	6	7	8	9	0	-	=	BS		
Tab	q	w	e	r	t	y	u	i	o	p	[]	\		
Caps Lock	a	s	d	f	g	h	j	k	l	;	'		return		
Shift	z	x	c	v	b	n	m	,	.	/	up		pg-up		
Ctrl	win	Alt							ins	del	lt	dn	rt	pgdn	

At pushed Shift key:

Input Panel															
Esc	F1	F2	F3	F4	F5	F6	F7	F8	F9	F10	F11	F12	Home	End	Prop
~	!	@	#	\$	%	^	&	*	()	_	+	BS		
Tab	Q	W	E	R	T	Y	U	I	O	P	{	}			
Caps Lock	A	S	D	F	G	H	J	K	L	:	"		return		
Shift	Z	X	C	V	B	N	M	<	>	?	up		pg-up		
Ctrl	win	Alt							ins	del	lt	dn	rt	pgdn	

- Home Position 1
- End End
- BS Backspace
- up ↑
- dn ↓
- lt ←
- rt →
- pgup Page↑
- pgdn Page↓
- ins Insert
- del Delete
- Tab Tabulator
- Shift
- Caps/Lock

Hide keyboard

The software keyboard allows you to enter key entries without connecting an external keyboard. As soon as an entry is required the software keyboard is automatically shown. *Hide Input Panel* hides the keyboard again.

System setting (Control Panel)

As many components of the *Control Panel* conform with the *System Control* of Windows®, most of the description is not necessary. The description of the control panel components relevant for operating the Panel PC can be found in the following:

- **Set Display**
Via 'Start → Settings → Control Panel → Display' the dialog windows for the display properties opens. Here you can change the settings for the monitor options.
- **Set Ethernet Parameters**
The dialog field for pre-setting an Ethernet address can be found in 'Start → Settings → Network and Dial-up Connections'. The default setting is address assignment via DHCP.



Please consider with the manual assignment of IP addresses that these are not identical for both interfaces.

- **System Properties (System)**

Via 'Start → Settings → Control Panel → System' you receive information about the version of the current Windows® operating system, the memory load and sharing (alterations here are not accepted into the registry) and the copyright. The register 'Device Name' allows you to change the device name that is shown during Ethernet communication for instance.

- **Regional Settings**

Via 'Start → Settings → Control Panel → Regional Settings' you can adjust the regional settings for the display of date, time, numbers and other formatting.



CAUTION

When changing the 'Regional Settings', please note that only *English* and *German* are supported, other languages can lead to a system crash.

3.6 Integrated server

3.6.1 General

Login data

The Panel PC has several integrated server that enable a remote maintenance within a network. Some servers only allow access by means of entering *User name* and *Password*. The following login data are used standardly:

User name: **wince**

Password: **vipatp**

Overview

Per default the following server are integrated:

- ftp server (activated)
- Telnet (activated)
- VNC (not activated)

Phrases

Phrases that are used in the description of the server:

Client

A client is an application that uses the service of a server within a network. For example, a web browser is a client because at every call of a website it sends a request to a web server and receives an answer.

Server

A server is an application that waits for the contact request of a client application and exchanges messages with it after contact start. This communication type is called Client-Server communication.

Host

Computer within a network where at least one server is running.

Download

Data transfer Server → Client

Upload

Data transfer Client → Server

3.6.2 ftp server

By means of a ftp server data between client and server can be exchanged. Here you can copy, delete or create files and directories.

Conditions for ftp access

Depending on the ftp client your PC must have the following conditions for a ftp connection. If there are still problems with the ftp access please ask your system administrator.

Internet Explorer

- ftp access possible with version 5.5 or higher
- activate directory view for ftp sites

For the adjustment choose in the Internet Explorer '*Options* → *Internet options*', register "extended" in the area "Browsing" and set the following settings:

1. activate: "activate directory view for ftp sites"
2. Restart the Internet Explorer.
 - ➔ The settings are saved.

Establishing a ftp connection

Below is explained, how to establish of a ftp connection between a Windows® based PC with Windows Explorer as ftp client and your Panel PC.

1. Connect your Panel PC with the network where your PC is a member via an Ethernet cable.
2. Switch on your Panel PC.
3. As soon as your Panel PC is connected via Ethernet, you can monitor the IP address data via  in the taskbar.

➔

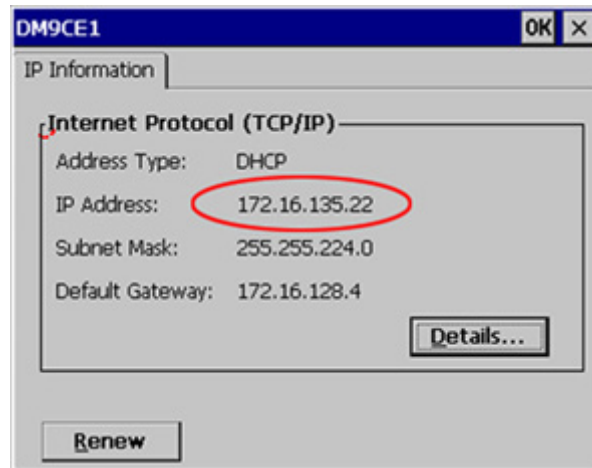

4. After you've confirmed the pre-settings, start your ftp client (e.g. Windows Explorer) and enter the following text into the "address bar":

```
ftp://wince:VIPATP@IP-Adresse
```

- ➔ In the appearing explorer window you can execute the requested file operations.

3.6.3 Telnet server

Telnet is a text based client-server protocol on TCP level. Using of a Telnet client like e.g. the "MS-DOS console" in your Windows® operating system you may execute text based all file remote functions at your Panel PC like copy, delete and create files and directories. You can also start applications. Terminating an application is not possible.

Establishing a Telnet connection

The establishing of a Telnet connection is password protected and has the following approach:

1. Start a Telnet client like for example "MS-DOS console" at your PC and enter the following into the address bar: `telnet IP address`.
 - ➔ When the connection is established, the Panel PC asks for the user name and the password.

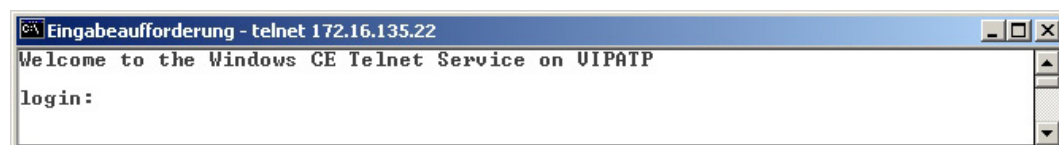

2. Enter the following:
 - Login: **wince**
 - Password: **vipatp** (entry is hidden)
 - ➔ After entering valid user data a command line for entries appears:

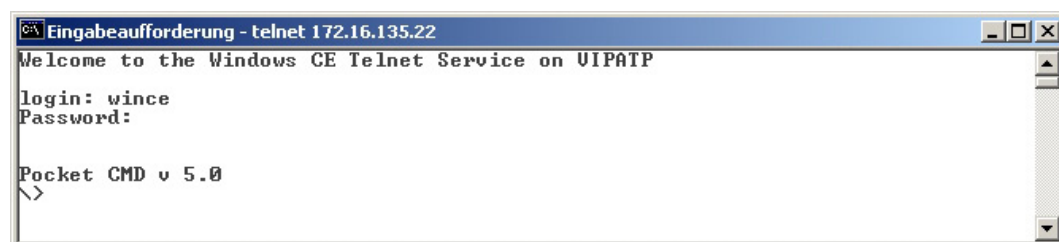

By entering `Exit` res. closing the window you can terminate the Telnet connection at any time.

Commands

After establishment of a Telnet connection the Panel PC provides you with commands. A list of possible commands with a short description is available via the command help. By beginning with "help" before a command you receive help to this command.

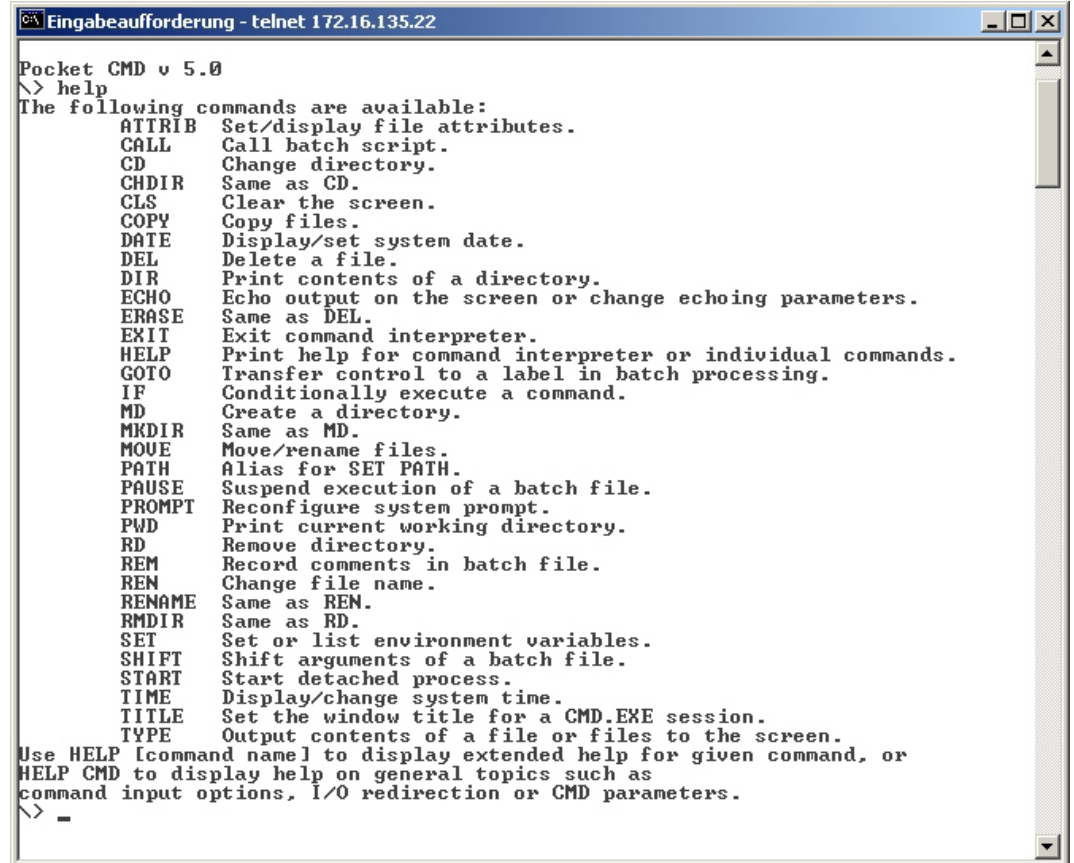

```

Eingabeaufforderung - telnet 172.16.135.22
Pocket CMD v 5.0
\> help
The following commands are available:
ATTRIB Set/display file attributes.
CALL Call batch script.
CD Change directory.
CHDIR Same as CD.
CLS Clear the screen.
COPY Copy files.
DATE Display/set system date.
DEL Delete a file.
DIR Print contents of a directory.
ECHO Echo output on the screen or change echoing parameters.
ERASE Same as DEL.
EXIT Exit command interpreter.
HELP Print help for command interpreter or individual commands.
GOTO Transfer control to a label in batch processing.
IF Conditionally execute a command.
MD Create a directory.
MKDIR Same as MD.
MOVE Move/rename files.
PATH Alias for SET PATH.
PAUSE Suspend execution of a batch file.
PROMPT Reconfigure system prompt.
PWD Print current working directory.
RD Remove directory.
REN Record comments in batch file.
RENAME Change file name.
RENAME Same as REN.
RMDIR Same as RD.
SET Set or list environment variables.
SHIFT Shift arguments of a batch file.
START Start detached process.
TIME Display/change system time.
TITLE Set the window title for a CMD.EXE session.
TYPE Output contents of a file or files to the screen.
Use HELP [command name] to display extended help for given command, or
HELP CMD to display help on general topics such as
command input options, I/O redirection or CMD parameters.
\> -

```

3.6.4 VNC server

The Panel PC has an integrated VNC server (virtual network control) that allows the total control of the Panel PC with a PC via network. For this, a window displays the current Panel PC content for remote control. Operation is performed via PC keyboard and mouse. Condition for the VNC communication is, that the VNC server is started on the Panel PC and a VNC client on the PC. You can download a VNC client as freeware from internet.



Because you can deactivate all safety attitudes with the VNC server, you should use these exclusively for start-up! For this reason the VNC server is on delivery deactivated.

Due to software reasons Yaskawa does not support the VNC server function!

Establishing a VNC connection

The VNC connection establishment has the following approach:

1. Start the VNC server via 'Start → Programs → Tools → winvnc' or activate the VNC server in the *Startup-Manager* under "Autostart".
 - ➔ To show the server has been started, the symbol Efon vnc appears in the task bar.
2. Now start the VNC client vncviewer.exe on your PC.

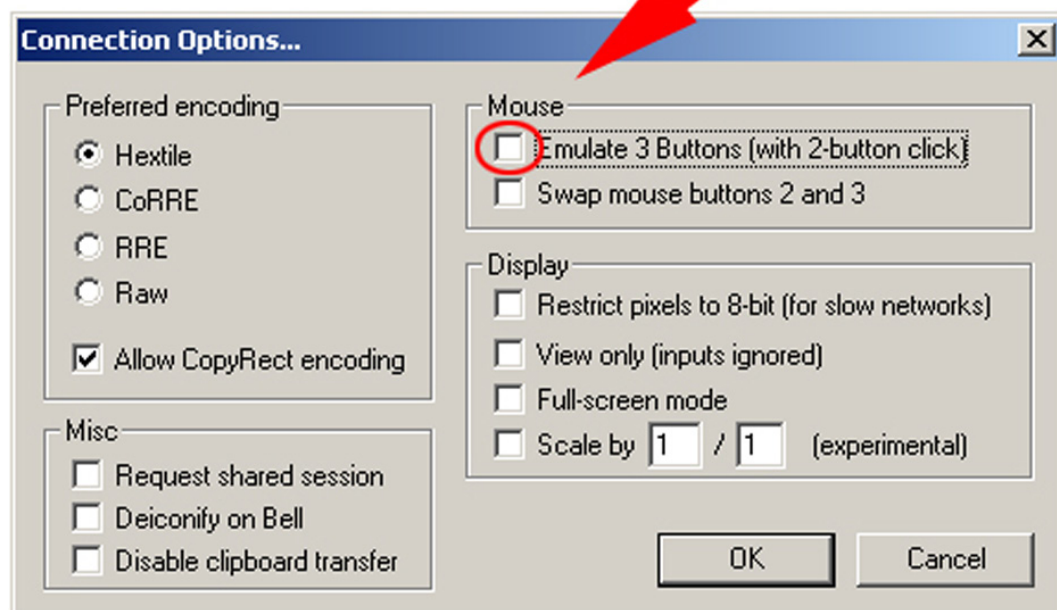
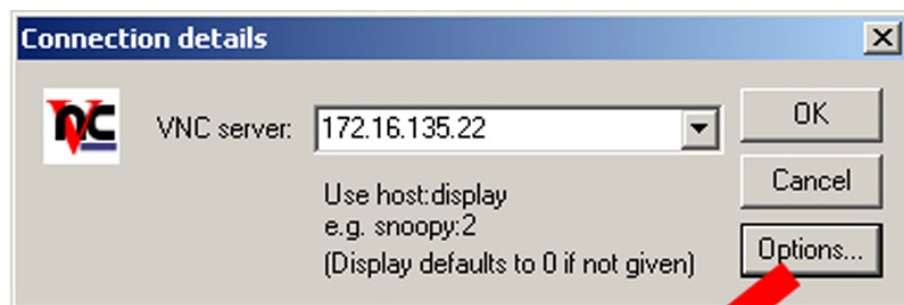

3. Click on [Options] and deactivate the field "Emulate 3 Buttons..." like shown at Mouse.
4. Enter the IP address of the Panel PC at VNC server. Click on [OK] and enter the password vipatp. You can change the password over the configuration file, for this execute vnconfig.exe. Now a VNC connection is established and the screen content of the Panel PC is monitored within a window.

Closing the VNC window terminates the VNC connection, the server keeps running.

3.7 Access to the network resources

Overview

The Panel PC allows you to access shared resources in a Microsoft network like drives and printer. Here you may assign existing public directories or printer in the network to local directories or printer in the Panel PC.

Condition for this is that you are logged in to the network with your user name and password. The assignment of a network resource is performed in the Panel PC via the command console "Command Prompt". Start the command console with 'START → Programs → Command Prompt'.

The access to the network resource is performed with the commands *Net view* and *Net use*.

List released resources

Shared resources of a network PC can be listed by the command: `\> net view PC-Name`

For example `net view testserver` lists all shared resources of the network PC "test server". To test the physical connection a PING to the IP address of the network PC may be executed if there are problems while contacting the network PC.

Connect net drive

The connection of a local name at the Panel PC with a shared drive of the network PC happens with the following approach:

1. → Enter the following in the command prompt: `\> net use local_name \network drive /user:User name`

2. → Enter *user name*, *password* and where app. *user group*.

After successful login the following message appears: '*Successfully mapped to network name*'.

The connected network drive is then available on the Panel PC with the *local name* via *My Device at Network*.

Example:

Local_Name: data, network drive: testserver\archive, Username: guest

Input: `\> net use data \\testserver\archiv /user:guest`. The connected network drive is then available via `\network\data` at the Panel PC.

List network connections

The listing command for all network connections of your Panel PC is `\> net use`.

Terminate network connections

You may terminate already assigned network resources via:

`\> net use local_name /d`

Example: `\> net use data /d` deletes the network connection to the drive "archive" of "test server".

4 BIOS setup

4.1 Overview

- In this chapter you will find information, required for calling the BIOS setup and the possible settings.
- The BIOS (Basic Input and Output System) setup program is a menu driven utility that enables you to make changes to the system configuration and tailor your system to suit your individual work needs. It is a ROM-based configuration utility that displays the system's configuration status and provides you with a tool to set system parameters.
- These parameters are stored in non-volatile battery-backed-up CMOS RAM that saves this information even when the power is turned off. When the system is turned back on, the system is configured with the values found in CMOS.
- With easy-to-use pull down menus, you can configure such items as:
 - Hard drives, diskette drives, and peripherals
 - Video display type and display options
 - Password protection from unauthorized use
 - Power management features

Configure the BIOS

This program should be executed under the following conditions:

- Changing the system configuration
- A configuration error is detected by the system and you are prompted to make changes to the setup program
- Resetting the system clock
- Redefining the communication ports to prevent any conflicts
- Making changes to the power management configuration
- Changing the password or making other changes to the security setup

Normally, CMOS setup is needed when the system hardware is not consistent with the information contained in the CMOS RAM, whenever the CMOS RAM has lost power or the system features need to be changed.

Default Configuration

Most of the configuration settings are either predefined according to the '*Load Optimal Defaults*' settings which are stored in the BIOS or are automatically detected and configured without requiring any actions. There are a few settings that you may need to change depending on your system configuration.

Entering BIOS setup

When the system is powered on, the BIOS will enter the Power-On Self Test (POST) routines. These routines perform various diagnostic checks; if an error is encountered, the error will be reported in one of two different ways:

- If the error occurs before the display device is initialized, a series of beeps will be transmitted.
- If the error occurs after the display device is initialized, the screen will display the error message.

Powering on the computer and immediately pressing *[Del]* allows you to enter Setup.

Selection boot medium

Powering on the computer and immediately pressing *[F7]* allows you, as long as the loading screen is shown, to change to the boot medium selection.

Legends

Key	Function
←→	Moves the highlight left or right to select a menu
↑↓	Moves the highlight up or down between submenus or fields
Ecs	Exits the BIOS setup utility
+ -	Scrolls forward or backward through the values or options of the highlighted field
Tabulator	Selects a field
F1	Displays General Help
F2	Load previous values
F3	Load optimized default values
F4	Saves and exits the setup program
Enter	Enters the highlighted submenu. When ► appears on the left of a particular field, it indicates that a submenu which contains additional options are available for that field.

BIOS setup utility

Main	Basic system configuration
Advanced	Extended system configuration
Chipset	Configuration chipset
Boot	Boot sequence
Security	Security settings
Save and Exit	Save and exit

4.2 Main

The Main menu is the first screen that you will see when you enter the BIOS setup utility.

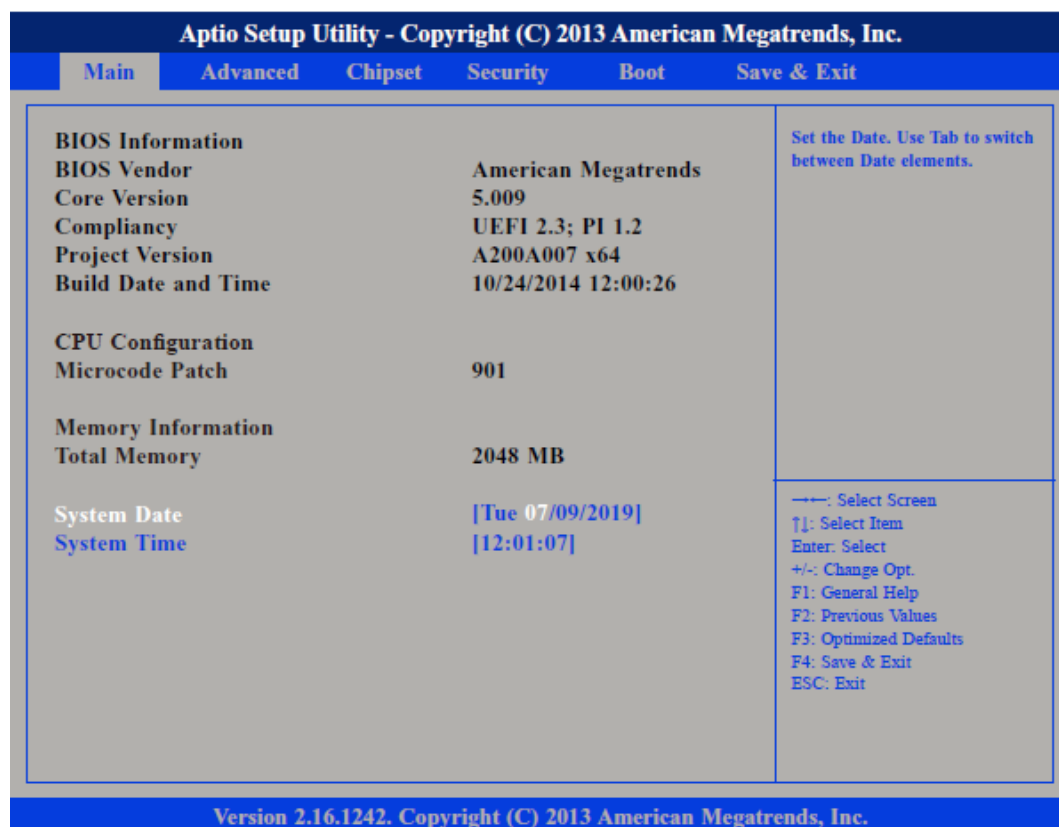
**System Date**

The date format is *day month/date/year* an.

- Day displays a day, from Monday to Sunday.
- Month displays the month, from January to December.
- Date displays the date, from 1 to 31.
- Year displays the year, from 1999 to 2099.

System Time

The time format is *hour:minute:second*.

- hour displays hours from 00 to 23.
- minute displays minutes from 00 to 59.
- second displays seconds from 00 to 59.

4.3 Advanced

This menu allows you to configure the system's extended functions. Here you can configure the CPU and the periphery.

**CAUTION**

Setting incorrect field values may cause the system to malfunction.



Submenu "ACPI Settings"

This section is used to configure *Advanced Configuration and Power Interface (ACPI) Settings*.

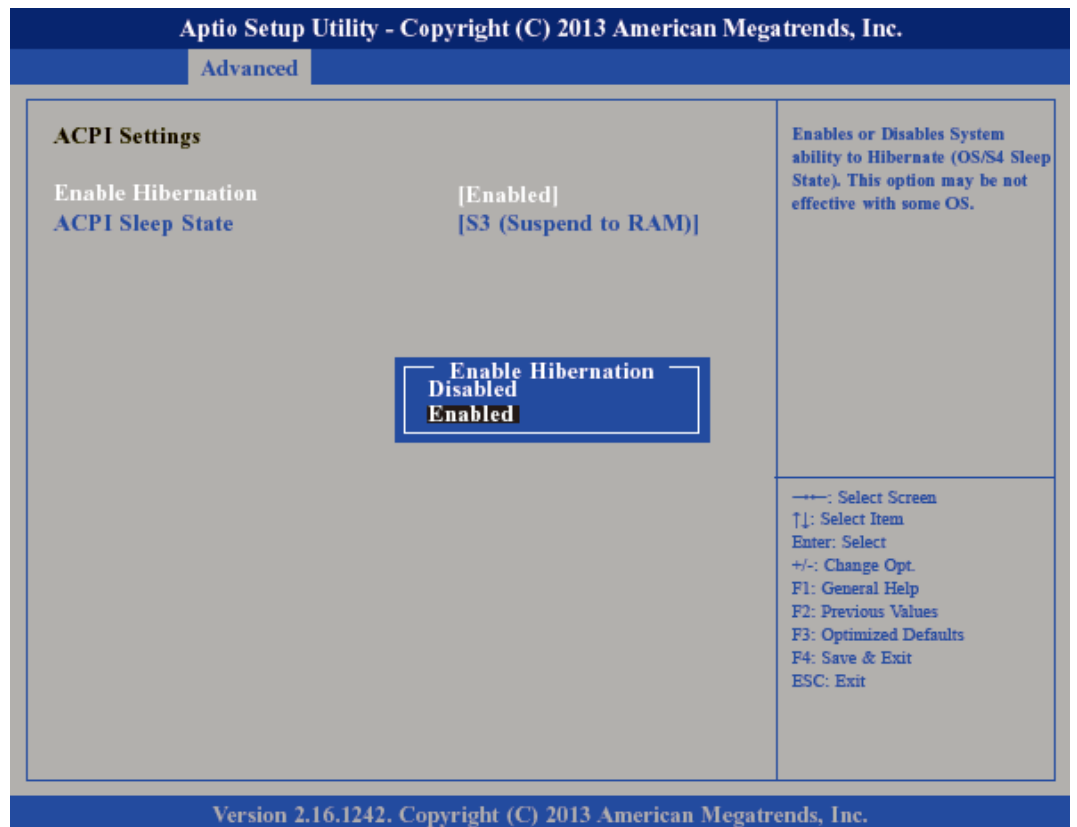

Enable Hibernation

Enables or disables (default) system ability to hibernate (*S4 Sleep State*).

Advanced

ACPI Sleep State



Select the highest *ACPI Sleep State* the system will enter when the suspend button is pressed.

Suspend Disabled Sleep state disabled

S3 (Suspend to RAM) Standby mode enabled, Windows saves the system state in RAM.

Submenu "IT8786E Super IO Configuration"

This section is used to configure serial ports.

**Super IO Chip**

Displays the *Super I/O Chip* used on the board.

Submenu "Serial Port 1 Configuration"

This section is used to configure serial port 1.



Advanced

Serial Port Enables or disables the serial port.
 Disabled Serial port is not available
 Enabled (default) Serial port is available

Device Settings Selects an optimal setting for the *Super IO Device*.

Onboard Serial Port Mode This field is used to configure the mode of serial port 0 as RS232 (default), RS422, RS485 or RS485 AUTO.

Terminal resistor Enables or disables the terminal resistor.
 Disabled Terminal resistor not activated
 Enabled (default) Terminal resistor activated

Submenu "Serial Port 2 Configuration" This section is used to configure serial port 2.



Serial Port Enables or disables the serial port.
 Disabled Serial port is not available
 Enabled (default) Serial port is available

Device Settings Selects an optimal setting for the *Super IO Device*.

Onboard Serial Port Mode This field is used to configure the mode of serial port 1 as RS232, RS422 (default), RS485 or RS485 AUTO.

Terminal resistor

Enables or disables the terminal resistor.

Disabled Terminal resistor not activated

Enabled (default) Terminal resistor activated

Submenu "H/W Monitor"

This section '*Pc Health Status*' is used to configure the hardware temperature and voltages.

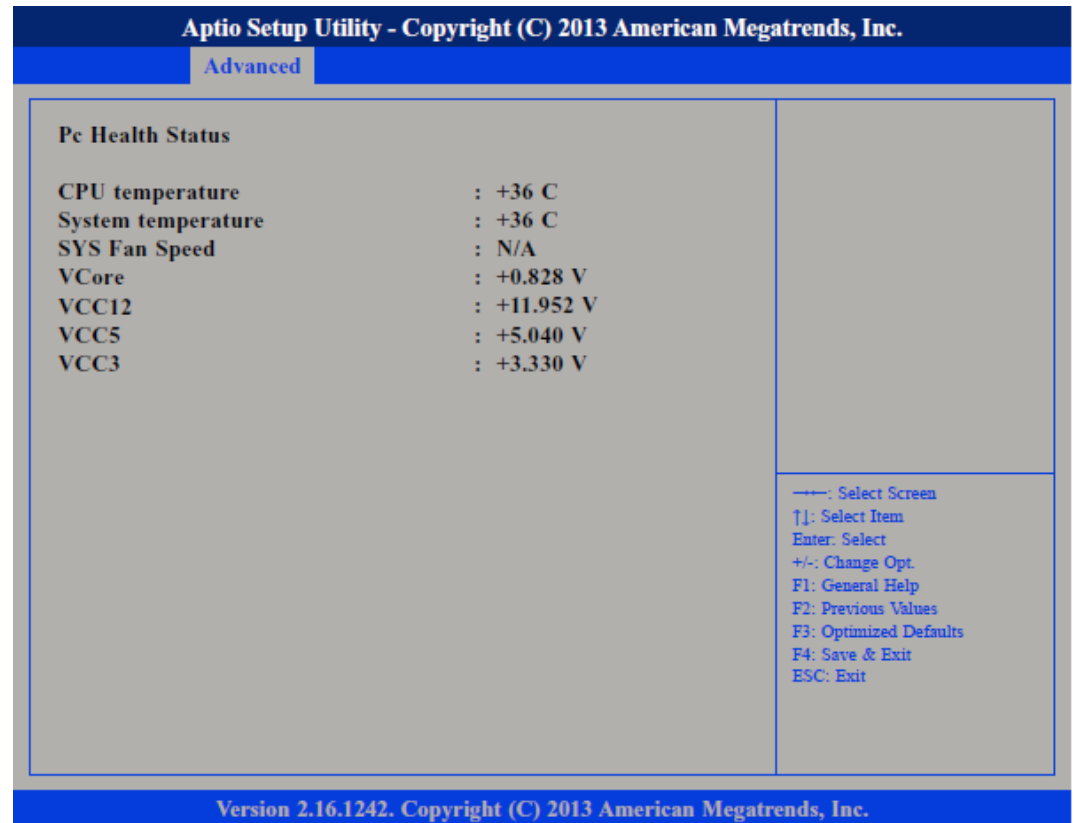
**Submenu "CPU Configuration"**

This section is used to configure the CPU.



Active Processors Cores

Select the number of cores to enable in each processor package.

Limit CPUID Maximum

The *CPUID* instruction of some newer CPUs will return a value greater than 3. The default is disabled because this problem does not exist in the Windows series operating systems. If you are using an operating system other than Windows, this problem may occur. To avoid this problem, enable this field to limit the return value to 3 or less than 3.

Disabled (default) All of the *CPUID* functions are supported.

Enabled Limit the return value to 3 or less than 3.

Execute Disable Bit

XD can prevent certain classes of malicious buffer overflow attacks.

Enabled Permit the switching on of the execute disable function by the OS.

Disabled Prevents the switching on of the execute disable function by the OS; it will force the XD feature flag to always return to 0.

Intel® Virtualization Technology

Enables or disables *Intel Virtualization Technology*.

Submenu "Socket 0 CPU Information"

Display information on the CPU installed on socket 0.

Aptio Setup Utility - Copyright (C) 2013 American Megatrends, Inc.

Advanced

<p>Socket 0 CPU Information</p> <p>Intel(R) Atom(TM) CPU E3826 @ 1.46GHz CPU Signature 30679 Microcode Patch 901 Max CPU Speed 1460 MHz Min CPU Speed 533 MHz Processor Cores 2 Intel HT Technology Not Supported Intel VT-x Technology Supported</p> <p>L1 Data Cache 24 kB x 2 L1 Code Cache 32 kB x 2 L2 Cache 512 kB x 1 L3 Cache Not Present</p>	<p>←→: Select Screen ↑↓: Select Item Enter: Select +/-: Change Opt. F1: General Help F2: Previous Values F3: Optimized Defaults F4: Save & Exit ESC: Exit</p>
--	---

Version 2.16.1242. Copyright (C) 2013 American Megatrends, Inc.

Submenu "PPM Configuration"

This section is used to configure the *Processor Power Management (PPM)* configuration.

Aptio Setup Utility - Copyright (C) 2013 American Megatrends, Inc.

Advanced

<p>PPM Configuration</p> <p>EIST [Disabled]</p>	<p>Enable/Disable Intel SpeedStep</p> <p>←→: Select Screen ↑↓: Select Item Enter: Select +/-: Change Opt. F1: General Help F2: Previous Values F3: Optimized Defaults F4: Save & Exit ESC: Exit</p>
--	---

Version 2.16.1242. Copyright (C) 2013 American Megatrends, Inc.

EIST

Enables or disables *Intel® SpeedStep*.

Advanced

Submenu "IDE Configuration"

This section is used to configure the IDE devices.



Serial-ATA (SATA) Enables or disables SATA controller.

SATA Speed Support Configures the *SATA controller* as Gen1 or Gen2.

SATA Mode Configures the SATA as IDE or AHCI mode.

IDE This option configures the serial ATA drives as parallel ATA physical storage device.

AHCI This option configures the serial ATA drives to use *AHCI (Advanced Host Controller Interface)*. AHCI allows the storage driver to enable the advanced serial ATA features which will increase storage performance.

Serial-ATA Port 0 Enables or disables SATA port 0.

SATA Port0 HotPlug Enables or disables *Hot Pluggable Support* on SATA port 0.

Serial-ATA Port 1 Enables or disables SATA port 1.

SATA Port1 HotPlug Enables or disables *Hot Pluggable Support* on SATA port 1.

Submenu "USB Configuration" This section is used to configure USB devices, such as keyboard, mouse and hub.

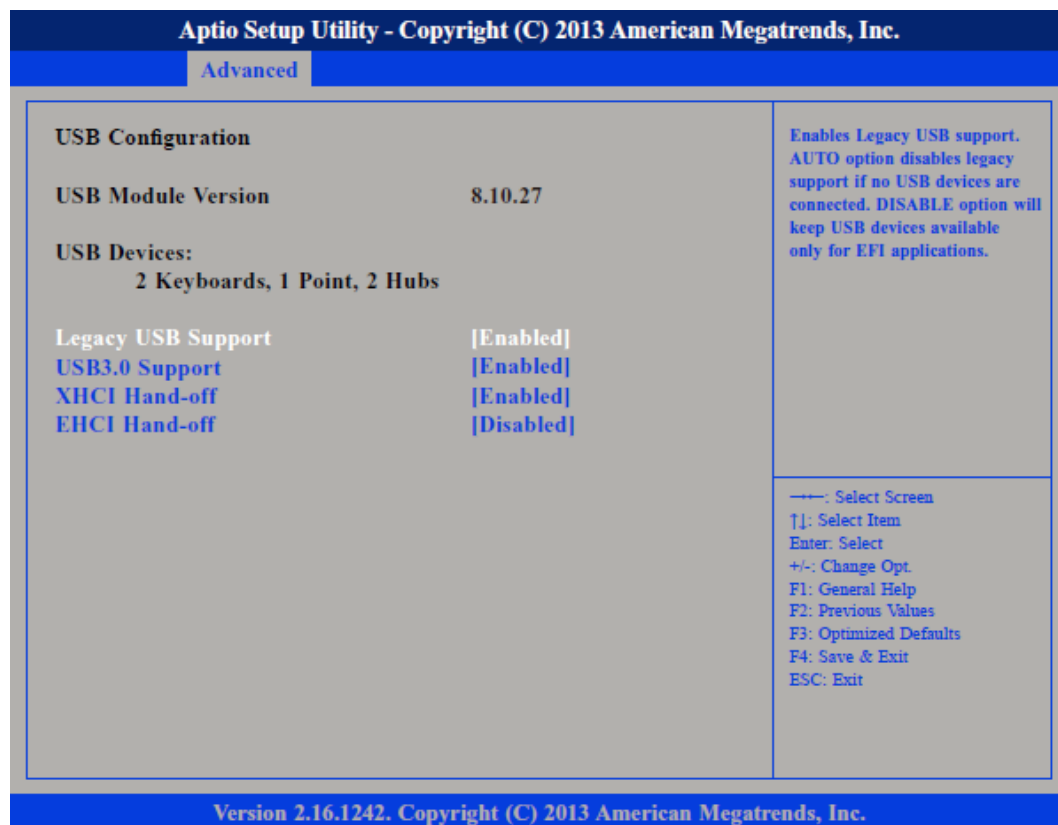
**Legacy USB Support**

Support of USB keyboard, mouse and storage media in EFI and DOS environments.

Enable (Default) Enables *Legacy USB*.

Auto Disables *Legacy USB Support* when no USB devices are connected.

Disable Keeps USB devices available only for EFI applications.

USB3.0 Support

Enabled (Default) Enables USB 3.0 controller support.

Disabled Disables USB 3.0 controller support.

XHCI Hand-off and EHCI Hand-off

Enabled Enables *XHCI* (USB 3.0) or *EHCI* (USB 2.0) support.

Disabled Disables *XHCI* (USB 3.0) or *EHCI* (USB 2.0) support.



When installing Windows 7 from USB, USB 3.0 will not be supported. Please disable XHCI and enable EHCI to allow USB installation of Windows 7.

4.4 Chipset

This section is used to configure the system based on the specific features of the chipset.

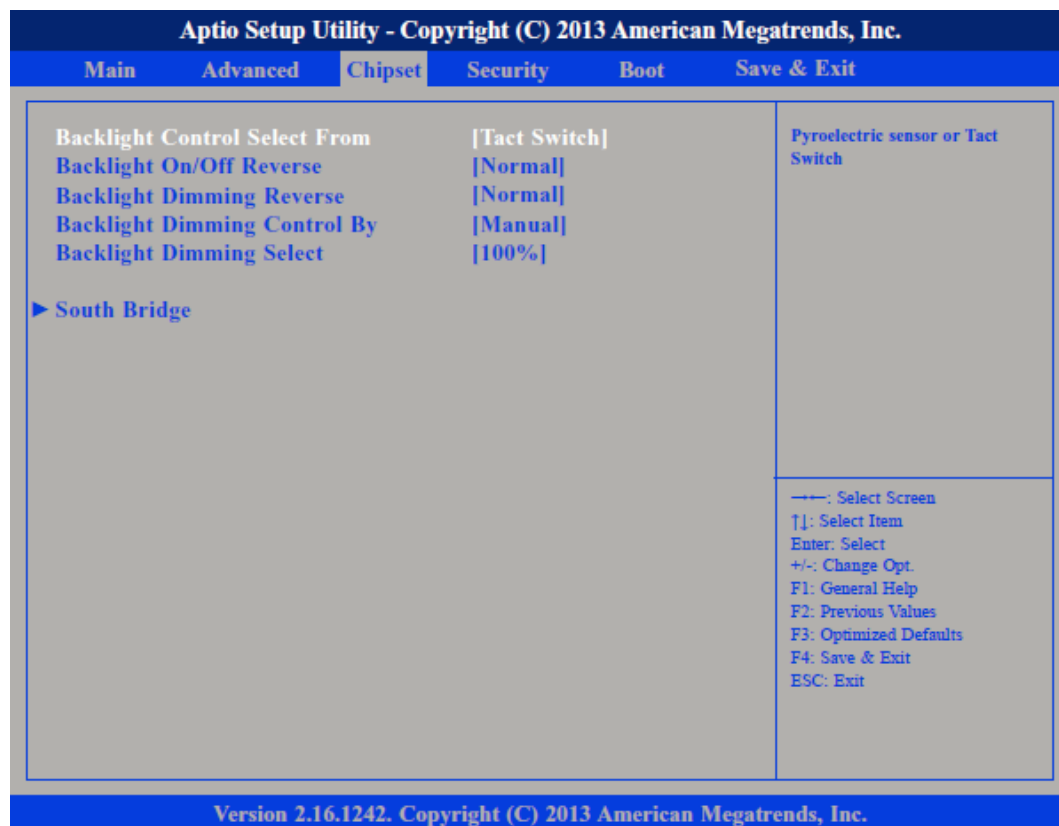

CAUTION

Setting incorrect field values may cause the system to malfunction.

Backlight Control Select From

The available options are 'Pyroelectric sensor' and 'Tact Switch'. The default setting is 'Tact Switch'.

Backlight On/Off Reverse

Please configure this option only when changing the panel, otherwise the display may not work.

Backlight Dimming Control By

The options are 'Tact Switch', 'Manual' and 'Light Sensor'. The default setting is 'Manual' and the Backlight option below will be configurable.

Backlight Dimming Select

Adjust the brightness of the backlight.

Submenu "South Bridge"

This field is used to configure the *South Bridge* chipset.

**High Precision Timer**

This section is used to configure *High Precision Event Timer*.

Restore AC Power Loss

System response when power returns after an AC power failure.

Last State The system will return to the state where you left off before power failure occurs.

Power Off The system's power is off. You must press the power button to Power On the system.

Power On (default) The system will automatically Power On.

Submenu "Azalia HD Audio"

This section disables Azalia or enables HD Audio.

Chipset



Audio Controller

Control detection of the Azalia device.

Disabled Azalia will be unconditionally disabled.

Enabled Azalia will be unconditionally enabled.

Azalia HDMI Codec

Enables or disables internal HDMI Codec for Azalia.

Submenu "USB Configuration"

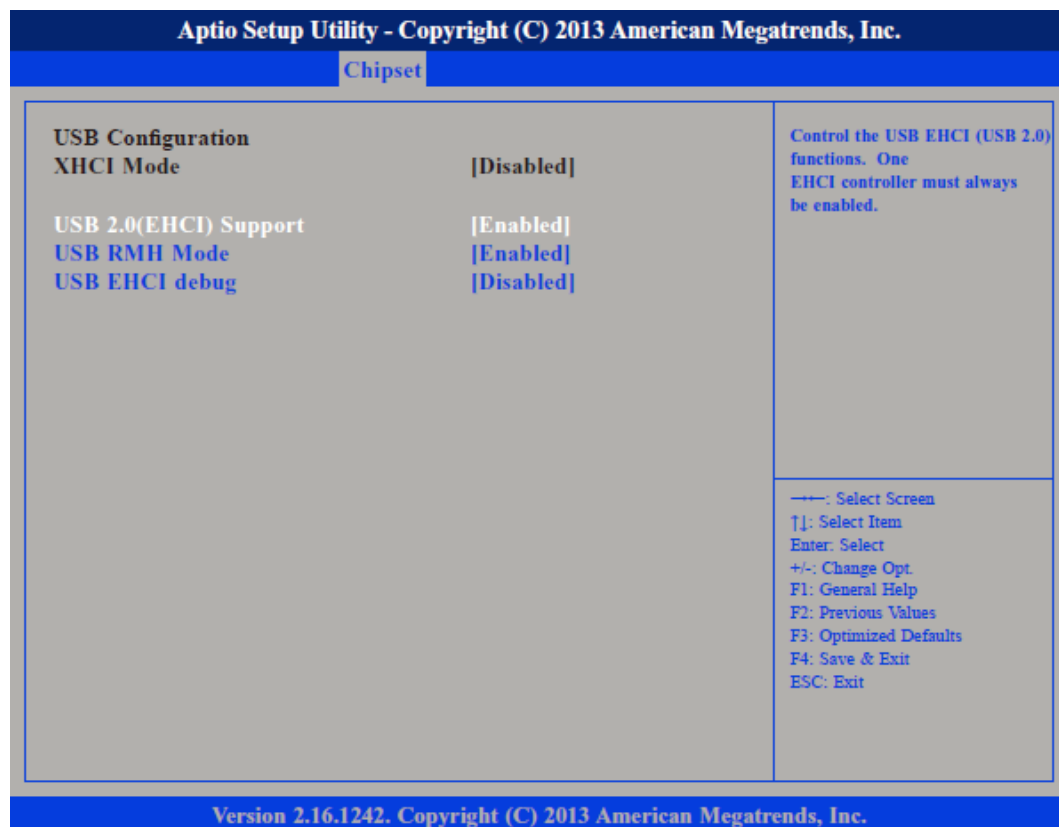
**USB 2.0(EHCI) Support**

Enables or disables the Enhanced Host Controller Interface (USB 2.0), one EHCI controller must always be enabled.

USB RMH Mode

Enables or disables PCH USB rate matching hubs mode.

USB EHCI debug

Enables or disables *PCH EHCI debug* capability.

Chipset

Submenu "PCI Express Configuration"



PCI Express Port 0 ... PCI Express Port 3

Enables or disables the PCI Express ports 0 ... 3 on the chipset.

4.5 Boot

This section is used to configure the boot features.



Bootup NumLock State

This allows you to determine the default state of the numeric keypad.

On (default) The function of the numeric keypad is the number keys.

Off The function of the numeric keypad is the arrow keys.

Fast Boot

When enabled, the BIOS will shorten or skip some check items during POST. This will decrease the time needed to boot the system.

Network

Controls the execution of UEFI and legacy PXE OpROM.

Onboard LAN PXE

Enables or disables the boot option for legacy network devices connected to LAN1 or LAN2.

Disabled (default) Starts no LAN PXE ROM

Enabled Starts the LAN PXE ROM, to be able to boot about PXE

Boot Option Priorities

Adjust the boot sequence of the system.

Hard Drive BBS Priorities

Sets the order of the legacy devices in this group.

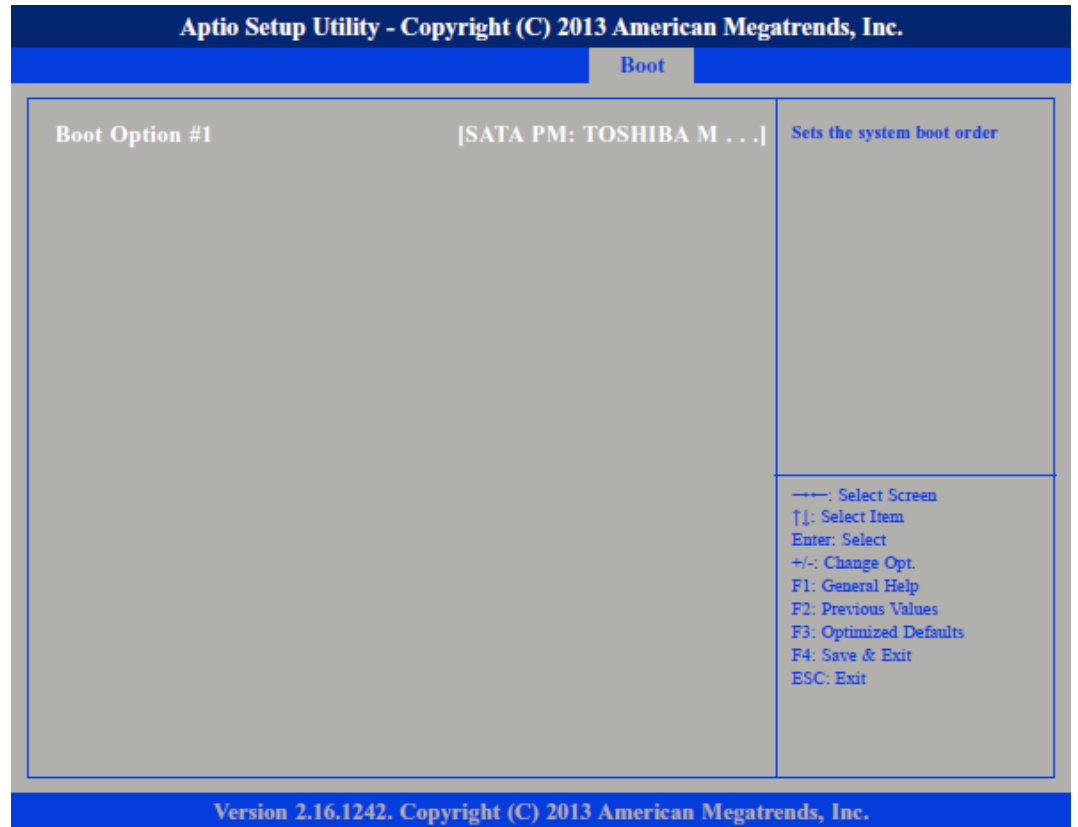

4.6 Security

If ONLY the Administrator's password is set

If only the Administrator's password is set, then this only limits access to setup and is only asked for when entering setup.

If ONLY the User's password is set

If only the User's password is set, then this is a power on password and must be entered to boot or enter setup. In Setup the user will have administrator rights.

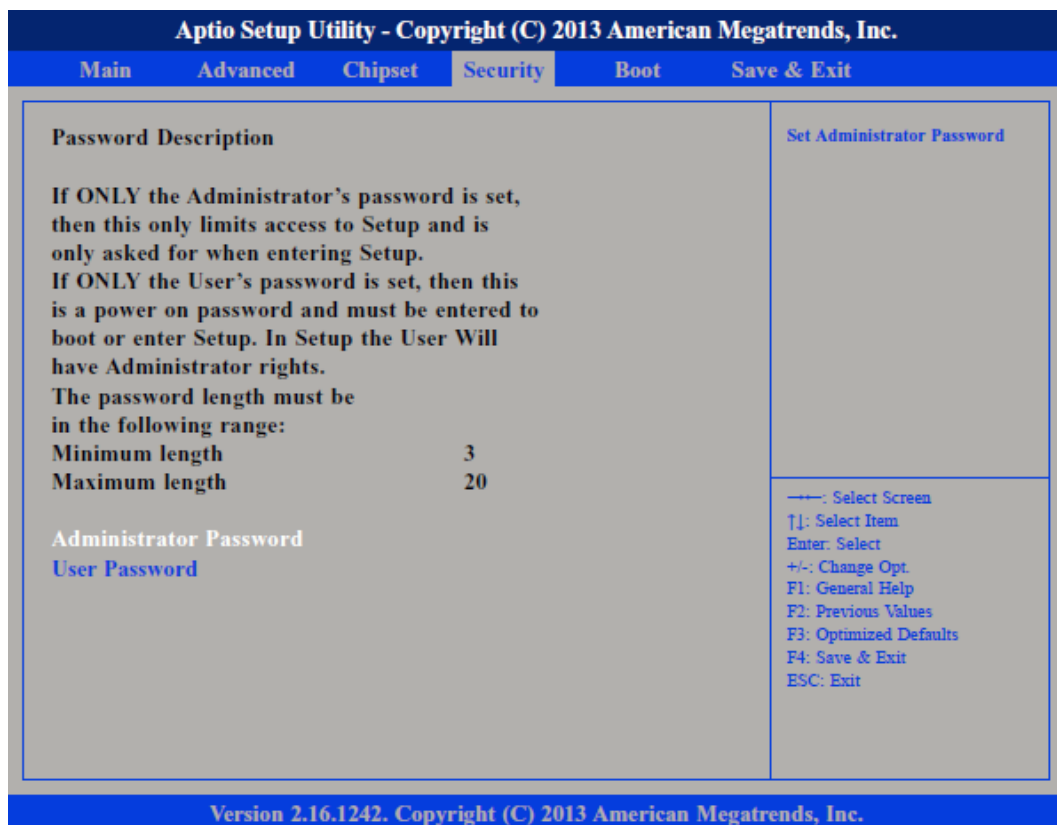

Administrator Password

Select this to reconfigure the administrator's password. Your password must contain at least 3 characters and should be maximal 20 characters long.

User Password

Select this to reconfigure the user's password. Your password must contain at least 3 characters and should be maximal 20 characters long.

4.7 Save and Exit



Save Changes and Reset

To save the changes and reset, select this field then press *[Enter]*. A dialog box will appear. Confirm by selecting *[Yes]*. A restart follows and the new settings become effective.

Discard Changes and Reset

To exit the Setup utility and reboot the system without saving the changes, select this field then press *[Enter]*. You may be prompted to confirm again before exiting. The BIOS setup exits and a restart follows.

Restore Defaults

To restore the BIOS to default settings, select this field then press *[Enter]*. A dialog box will appear. Confirm by selecting *[Yes]*.

Save Changes and Exit

To save the changes and exit the setup utility press *[F4]*.

Discard Changes and Exit

To exit the Setup utility without saving the changes *[Esc]*. The BIOS setup exits and the POST continued.

5 Industrial Security and Installation guidelines

5.1 Industrial security in information technology

Latest version	This chapter can also be found as a guide ' <i>Industrial IT Security</i> ' in the ' <i>Download Center</i> ' of www.yaskawa.eu.com
Hazards	<p>The topic of data security and access protection has become increasingly important in the industrial environment. The increased networking of entire industrial systems to the network levels within the company together with the functions of remote maintenance have all served to increase vulnerability. Hazards can arise from:</p> <ul style="list-style-type: none">■ Internal manipulation such as technical errors, operating and program errors and deliberate program or data manipulation.■ External manipulation such as software viruses, worms and trojans.■ Human carelessness such as password phishing.
Precautions	<p>The most important precautions to prevent manipulation and loss of data security in the industrial environment are:</p> <ul style="list-style-type: none">■ Encrypting the data traffic by means of certificates.■ Filtering and inspection of the traffic by means of VPN - "Virtual Private Networks".■ Identification of the user by "Authentication" via save channels.■ Segmenting in protected automation cells, so that only devices in the same group can exchange data.■ Deactivation of unnecessary hardware and software.
Further Information	<p>You can find more information about the measures on the following websites:</p> <ul style="list-style-type: none">■ Federal Office for Information Technology → www.bsi.bund.de■ Cybersecurity & Infrastructure Security Agency → us-cert.cisa.gov■ VDI / VDE Society for Measurement and Automation Technology → www.vdi.de

5.1.1 Protection of hardware and applications

Precautions

- Do not integrate any components or systems into public networks.
 - Use VPN "Virtual Private Networks" for use in public networks. This allows you to control and filter the data traffic accordingly.
- Always keep your system up-to-date.
 - Always use the latest firmware version for all devices.
 - Update your user software regularly.
- Protect your systems with a firewall.
 - The firewall protects your infrastructure internally and externally.
 - This allows you to segment your network and isolate entire areas.
- Secure access to your plants via user accounts.
 - If possible, use a central user management system.
 - Create a user account for each user for whom authorization is essential.
 - Always keep user accounts up-to-date and deactivate unused user accounts.
- Secure access to your plants via secure passwords.
 - Change the password of a standard login after the first start.
 - Use strong passwords consisting of upper/lower case, numbers and special characters. The use of a password generator or manager is recommended.
 - Change the passwords according to the rules and guidelines that apply to your application.
- Deactivate inactive communication ports respectively protocols.
 - Only the communication ports that are used for communication should be activated.
 - Only the communication protocols that are used for communication should be activated.
- Consider possible defence strategies when planning and securing the system.
 - The isolation of components alone is not sufficient for comprehensive protection. An overall concept is to be drawn up here, which also provides defensive measures in the event of a cyber attack.
 - Periodically carry out threat assessments. Among others, a comparison is made here between the protective measures taken and those required.
- Limit the use of external storage media.
 - Via external storage media such as USB memory sticks or SD memory cards, malware can get directly into a system while bypassing a firewall.
 - External storage media or their slots must be protected against unauthorized physical access, e.g. by using a lockable control cabinet.
 - Make sure that only authorized persons have access.
 - When disposing of storage media, make sure that they are safely destroyed.
- Use secure access paths such as HTTPS or VPN for remote access to your plant.
- Enable security-related event logging in accordance with the applicable security policy and legal requirements for data protection.

5.1.2 Protection of PC-based software

Precautions

Since PC-based software is used for programming, configuration and monitoring, it can also be used to manipulate entire systems or individual components. Particular caution is required here!

- Use user accounts on your PC systems.
 - If possible, use a central user management system.
 - Create a user account for each user for whom authorization is essential.
 - Always keep user accounts up-to-date and deactivate unused user accounts.
- Protect your PC systems with secure passwords.
 - Change the password of a standard login after the first start.
 - Use strong passwords consisting of upper/lower case, numbers and special characters. The use of a password generator or manager is recommended.
 - Change the passwords according to the rules and guidelines that apply to your application.
- Enable security-related event logging in accordance with the applicable security policy and legal requirements for data protection.
- Protect your PC systems by security software.
 - Install virus scanners on your PC systems to identify viruses, trojans and other malware.
 - Install software that can detect phishing attacks and actively prevent them.
- Always keep your software up-to-date.
 - Update your operating system regularly.
 - Update your software regularly.
- Make regular backups and store the media at a safe place.
- Regularly restart your PC systems. Only boot from storage media that are protected against manipulation.
- Use encryption systems on your storage media.
- Perform security assessments regularly to reduce the risk of manipulation.
- Use only data and software from approved sources.
- Uninstall software which is not used.
- Disable unused services.
- Activate a password-protected screen lock on your PC systems.
- Always lock your PC systems as soon as you leave your PC workstation.
- Do not click any links that come from unknown sources. If necessary ask, e.g. on e-mails.
- Use secure access paths such as HTTPS or VPN for remote access to your PC system.

5.2 Installation guidelines

5.2.1 Basic rules for the EMC-equitable assembly of installations

General

The installation guidelines contain information about the interference free deployment of a PLC system. There is the description of the ways, interference may occur in your PLC, how you can make sure the electromagnetic compatibility (EMC), and how you manage the isolation.

What does EMC mean?

Electromagnetic compatibility (EMC) means the ability of an electrical device, to function error free in an electromagnetic environment without being interfered respectively without interfering the environment.

The components are developed for the deployment in industrial environments and meets high demands on the EMC. Nevertheless you should project an EMC planning before installing the components and take conceivable interference causes into account.

Possible interference causes

Electromagnetic interferences may interfere your control via different ways:

- Electromagnetic fields (RF coupling)
- Magnetic fields with power frequency
- Bus system
- Power supply
- Protected earth conductor

Depending on the spreading medium (lead bound or lead free) and the distance to the interference cause, interferences to your control occur by means of different coupling mechanisms.

There are:

- galvanic coupling
- capacitive coupling
- inductive coupling
- radiant coupling

Coupling mechanisms and interference sources

The following table shows the four different coupling mechanisms, their causes and possible interference sources.

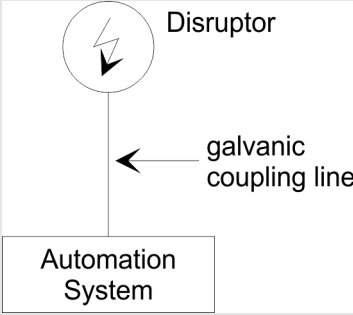
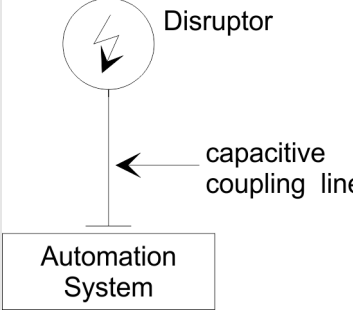
Coupling mechanism	Cause	Typical source
<p>Galvanic coupling</p> 	Galvanic or metallic coupling always occurs, when two current circuits have a common line.	<ul style="list-style-type: none"> ■ Pulsed devices (Net influence from transducers and foreign net devices) ■ Starting motors ■ Different potential of component cubicles with common current supply ■ Static discharges
<p>Capacitate coupling</p> 	Capacitate or electric coupling occurs between conductors with different potential. The coupling is proportionate to the temporal change of the voltage.	<ul style="list-style-type: none"> ■ Interference through parallel signal lines ■ Static discharge of the personnel ■ Contactors

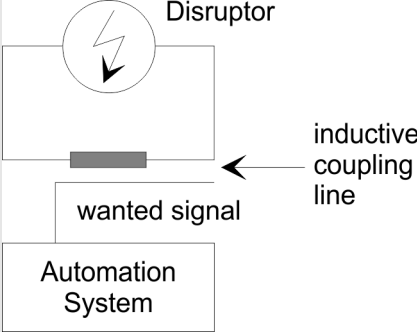
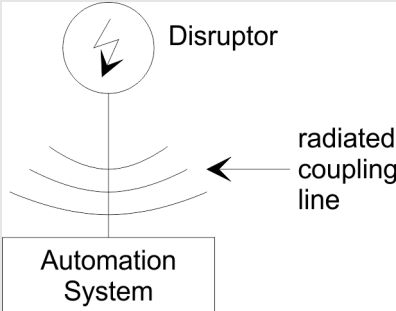
Coupling mechanism	Cause	Typical source
<p>Inductive coupling</p> 	<p>Inductive or magnetic coupling occurs between two current active line loops. The magnetic flows associated with the currents induct interference voltages. The coupling is proportional to the time related change of the current.</p>	<ul style="list-style-type: none"> ■ Transducers, motors, electric welding devices ■ Parallel net cables ■ Cables with toggled currents ■ Signal cable with high frequency ■ Unused coils
<p>Radiate power coupling</p> 	<p>One talks of radiate power coupling, when an electromagnetic wave meets a line circuit. The hit of the wave inducts currents and voltages.</p>	<ul style="list-style-type: none"> ■ Sender in the neighbourhood (e.g. walkie-talkie) ■ Sparking lines (sparking plugs, collector of electric motors, welding devices)

Basic rules for EMC

In the most times it is enough to take care of some elementary rules to guarantee the EMC. Please regard the following basic rules when installing your PLC.

- Take care of a correct area-wide grounding of the inactive metal parts when installing your components.
 - Install a central connection between the ground and the protected earth conductor system.
 - Connect all inactive metal extensive and impedance-low.
 - Please try not to use aluminium parts. Aluminium is easily oxidizing and is therefore less suitable for grounding.
- When cabling, take care of the correct line routing.
 - Organize your cabling in line groups (high voltage, current supply, signal and data lines).
 - Always lay your high voltage lines and signal respectively data lines in separate channels or bundles.
 - Route the signal and data lines as near as possible beside ground areas (e.g. suspension bars, metal rails, tin cabinet).
- Proof the correct fixing of the lead isolation.
 - Data lines must be shielded.
 - Analog lines must be shielded. When transmitting signals with small amplitudes the one sided laying of the isolation may be favourable.
 - Cables for frequency inverters, servo and stepper motors must be shielded.
 - Lay the line isolation extensively on an isolation/protected earth conductor rail directly after the cabinet entry and fix the isolation with cable clamps.
 - Make sure that the isolation/protected earth conductor rail is connected impedance-low with the cabinet.
 - Use metallic or metallised plug cases for isolated data lines.

- In special use cases you should appoint special EMC actions.
 - Consider to wire all inductivities with erase links.
 - Please consider luminescent lamps can influence signal lines.
- Create a homogeneous reference potential and ground all electrical operating supplies when possible.
 - Please take care for the targeted employment of the grounding actions. The grounding of the PLC serves for protection and functionality activity.
 - Connect installation parts and cabinets with your PLC in star topology with the isolation/protected earth conductor system. So you avoid ground loops.
 - If there are potential differences between installation parts and cabinets, lay sufficiently dimensioned potential compensation lines.

5.2.2 EMC-equitable assembly

Mostly, measures for suppressing interference voltages are only taken, when the control is already in commission and the perfect receive of a wanted signal is disturbed. Causes for such interference's are in the most cases inadequate reference potentials, coming from mistakes at the device assembly and installation.

Guidelines for assembling and grounding of inactive metal parts

When assembling the devices, you have to ensure the large-surface grounding of the inactive metal parts. A correctly done grounding supports an unambiguous reference potential for the control and reduces the impact of coupled interferences.

Grounding means the conducting connection of all inactive metal parts. The sum of all interconnected inactive parts is called ground.

Inactive parts are all conductive parts electrically separated from all active parts by means of a basic isolation and that may only get voltage in case of an error.

The ground must not adopt dangerous contact voltage even in case of an error. Thus you have to connect the ground with the protected earth conductor. To avoid ground loops, local distant ground constructions (cubicles, construction and machine parts) have to be connected with the protected earth conductor system in star-topology.

Please regard at grounding:

- Connect the inactive metal parts as carefully as the active ones.
- Take care of impedance-low metal-metal-connections, e.g. with large-surface and well conductive contacts.
- If you include coated or anodized metal parts in the grounding, you have to come through the isolating protection layers. For this you may use special contact washers or remove the isolation layer.
- Protect the connection points from corrosion, e.g. with grease.
- Moveable grounding parts (e.g. cubicle doors) have to be connected via flexible ground strips. The ground strips should be short and have a large surface, because the surface is decisive for the diversion of high frequency interferences.

5.2.3 EMC-equitable cabling

Line routing

Content of this section is the line routing of bus, signal and supply lines. Object of the line routing is to suppress the "slurring" at parallel lines.

Line routing inside and outside of cubicles

For an EMC-equitable routing of the lines it is convenient to divide the cables in different groups and install each group itself:

Group A

- screened bus and data lines
- screened analog lines
- unshielded lines for direct voltage $\leq 60V$
- unshielded lines for alternating voltage $\leq 25V$
- Coaxial cables for monitors

Group B

- unshielded lines for direct voltage $> 60V$ and $\leq 400V$
- unshielded lines for alternating voltage $> 25V$ and $\leq 400V$

Group C

- unshielded lines for direct and alternating voltage $> 400V$

Group D

- Lines for H1 respectively TCP/IP

Combination of groups

Following the table you may see the conditions for the cabling of the line groups by combining the single groups:

	Group A	Group B	Group C	Group D
Group A	[1]	[2]	[3]	[4]
Group B	[2]	[1]	[3]	[4]
Group C	[3]	[3]	[1]	[4]
Group D	[4]	[4]	[4]	[1]

[1]	The lines may be installed in common bundles or cable trusses.
[2]	The lines have to be installed in different bundles or cable trusses (without min. distance).
[3]	The lines have to be installed in different bundles or cable trusses inside of cubicles and outside of the cubicle but inside the building in separated cable trusses with a min. distance of 10cm.
[4]	The lines have to be installed in different bundles or cable trusses with a min. distance of 50cm.

Line routing outside of buildings

Wherever possible, exterior cabling should be installed on metallic cable trays. A galvanic connection must be provided for joints between cable trays. You must abide by the applicable lightning protection and grounding regulations when installing exterior cables.

Lightning protection**CAUTION**

Where cables and signal lines for PLC equipment are installed outside of buildings, the conditions for internal and external lightning protection must be satisfied.

- Exterior lines should either be installed in metallic conduit pipes that is grounded on both ends or in steel-reinforced concrete cable trunks with continuously connected reinforcing.
- Signal lines should be protected against overvoltage by varistors or by lightning arrester filled with rare gas.
- Install these protective elements at the location where the cables enter the building.



Any lightning protection system must be based on an individual assessment of the entire plant. For questions please contact Yaskawa.

Equipotential bonding

Potential differences can occur between different sections when controllers and peripheral equipment are connected by means of non-isolated connections or the screens of screened cables are connected at both ends and grounded on different sections of the plant. One reason for a potential difference can be that different sections of the plant are powered from different power sources. These potential differences must be reduced by means of equipotential bonding conductors to ensure that the electronic equipment employed on the plant operates properly.

Rules for equipotential bonding

- The lower the impedance of the equipotential bonding conductor, the higher the effectiveness of potential equalization.
- The impedance of the equipotential bonding conductor must not exceed 10% of the impedance of the screen where screened signal lines are connected between the different sections of the plant and the screening is connected to ground/neutral on both sides.
- The cross-sectional area of the equipotential bonding conductor must be calculated to carry the maximum equalization current. The following cross-sections have been successfully employed:
 - 16mm² Cu for equipotential bonding conductors up to 200m
 - 25mm² Cu equipotential bonding conductors exceeding 200m.
- Use copper or galvanized steel for equipotential bonding conductors. These must be connected to ground/neutral by means of large-surface connections that are protected from corrosion.
- The equipotential bonding conductor should be installed in such a manner that it includes the smallest surface between the bonding conductor and the signal lines.

Screening of lines and cables

Screening is one method commonly used to reduce (attenuate) the interference pick-up from magnetic, electrical or electromagnetic fields.

- Interference on screens is conducted to ground by the conductive connection between the screen and the screening rain/enclosure. To avoid interference from these currents it is very important that the neutral connection is a low-impedance connection.
- You should only use cables that are provided with a braided screen. The degree of screening should be more than 80%.

- Avoid cables with foil-type screens as the foil can be easily damaged by tension and pressure at the point of attachment; this can result in reduced effectiveness of the screening action.
- As a rule you should always ground the screens of cables on both ends. This is the only way in which you can ensure that high frequency interference is attenuated properly.

One-sided grounding of screens

In exceptional cases it may be necessary to ground the screen on one side only. However, this will only attenuate the lowest frequencies. The one-sided grounding of screens may provide advantages when:

- It is not possible to install an equipotential bonding conductor
- Analogue signals (a few mV or mA) must be transmitted
- Foil-type screening (static screening) is employed.

You should always use metallic or metallised covers for serial data lines. Connect the screen of the data line to the cover. Do **not** connect the screen to PIN 1 of the connector! In case of stationary operations it is recommended that the remove the insulation from the screened cable without cutting the screen and to attach this point to the screening/neutral rail.



Potential differences can give rise to an equalization current via the screen connected between the two ground connections. In this case you must install an additional equipotential bonding conductor.

Connecting the screen

Please observe the following points when you handle the screens:

- Use only metallic cable clamps when connecting the screening of cables. These clamps must provide a good electrical contact and a large-surface connection to the screen.
- Attach the screens to the screening rail directly at the point where the cables enter the enclosure. The screening conductor must be continued to the module without interruption, however, it must not be connected to the module!

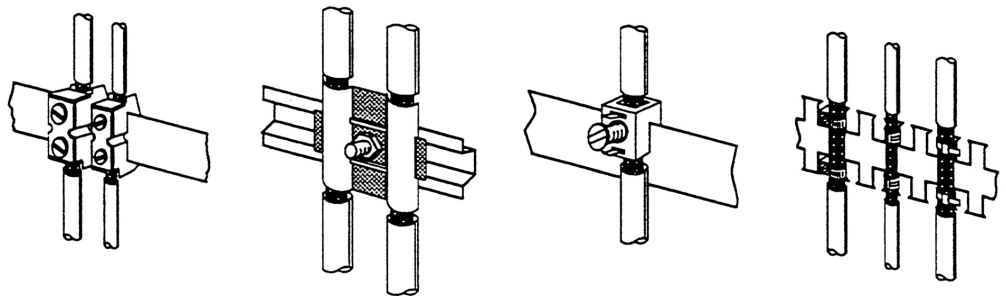

5.2.4 Special precautions providing high noise immunity

Inductors require snubber networks

Inductors controlled by your programmable controller (e.g. contactors and relays) do not normally require additional snubber networks or suppressors as the respective modules have been provided with the required components.

Equipotential bonding

Snubber networks must only be connected to inductors when output circuits can be disabled by means of additional contacts (e.g. relay contacts). In this case the integrated suppressors on the module are also disabled. You can connect diodes to suppress back-emf, varistors or RC-networks to the inductors.

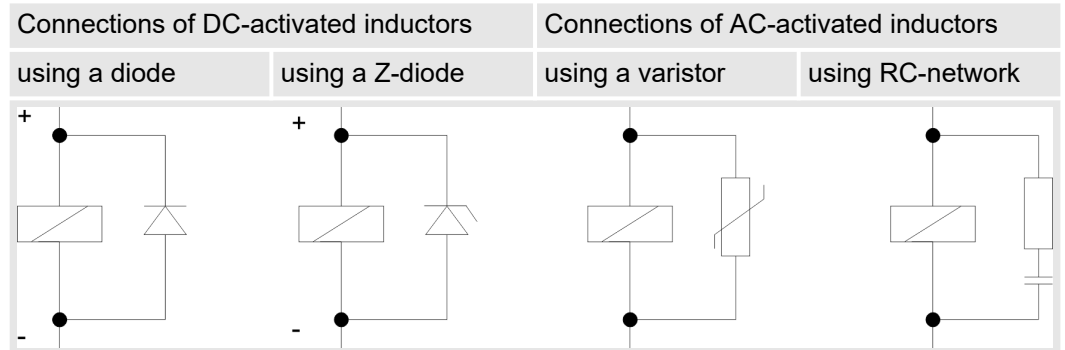

Power outlet for PGs

Every cubicle must be provided with a power outlet for the PU. These outlets must be wired to the distribution system, which is also used to connect the neutral conductor for the cubicle.

Cubicle illumination

The cubicle illumination should consist of incandescent lights, e.g. LINESTRA-lamps. Avoid using fluorescent lamps as these lamps can cause interference. If you can not avoid using fluorescent lamps you should implement the steps outlined in the following figure.

Suppression of fluorescent lamps in cubicles

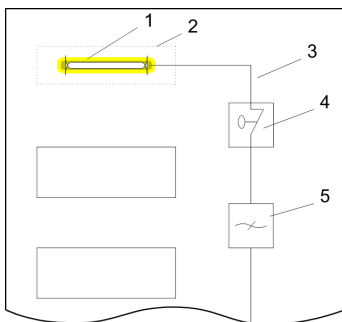

- 1 Fluorescent lamp
- 2 Screen above the lamp
- 3 Screened cable
- 4 Switch with metallic cover
- 5 Line filter or screened power cable

5.2.5 Checklist for the EMC-compliant installation of controllers

EMC-measures	Space for Notes
Connection of the inactive parts	
You should take special care to check the connections of:	
<ul style="list-style-type: none"> ■ Module racks ■ Frames ■ Screen and protected earth conductor 	
Are all the inactive metal parts interconnected by means of large-surface and low-impedance connections?	
Has a proper connection been installed with respect to the ground/protected earth conductor system?	
Has the isolation been removed from varnished and anodized surfaces or have these connections been fitted with special contact washer?	
Have the connection been protected from corrosion, e.g. by means of grease?	
Have doors been grounded by means of grounding straps connected to the body of the cubicle?	
Cable routing	
Cabling divided into groups?	
Power cables (230 ... 400V) and signal lines installed in separate channels or bunches?	
Potential compensating	
When installing the equipment at separate locations, check the installation of the potential compensating line.	
Cable screen	
All covers of plugs are metallic?	
All analog and data lines installed screened?	
Line screens attached to the screening or the protected earth conductor?	
Have the screens been connected by means of large-surface and low-impedance cable clamps?	
Cable screens grounded both-sided where possible?	
Inductors	
Have the coils of contactors controlled by means of contacts been connected to snubber networks?	