

# VIPA Accessories

**306-1UE00 | Manual**

HB37E\_IM | RE\_306-1UE00 | Rev. 15/22

May 2015

## **Copyright © VIPA GmbH. All Rights Reserved.**

This document contains proprietary information of VIPA and is not to be disclosed or used except in accordance with applicable agreements.

This material is protected by the copyright laws. It may not be reproduced, distributed, or altered in any fashion by any entity (either internal or external to VIPA), except in accordance with applicable agreements, contracts or licensing, without the express written consent of VIPA and the business management owner of the material.

For permission to reproduce or distribute, please contact:  
VIPA, Gesellschaft für Visualisierung und Prozessautomatisierung mbH  
Ohmstraße 4, D-91074 Herzogenaurach, Germany  
Tel.: +49 (91 32) 744 -0  
Fax.: +49 9132 744 1864  
EMail: [info@vipa.de](mailto:info@vipa.de)  
<http://www.vipa.com>

## **Note**

Every effort has been made to ensure that the information contained in this document was complete and accurate at the time of publishing. Nevertheless, the authors retain the right to modify the information. This customer document describes all the hardware units and functions known at the present time. Descriptions may be included for units which are not present at the customer site. The exact scope of delivery is described in the respective purchase contract.

## **CE Conformity Declaration**

Hereby, VIPA GmbH declares that the products and systems are in compliance with the essential requirements and other relevant provisions.

Conformity is indicated by the CE marking affixed to the product.

## **Conformity Information**

For more information regarding CE marking and Declaration of Conformity (DoC), please contact your local VIPA customer service organization.

## **Trademarks**

VIPA, SLIO, System 100V, System 200V, System 300V, System 300S, System 400V, System 500S and Commander Compact are registered trademarks of VIPA Gesellschaft für Visualisierung und Prozessautomatisierung mbH.

SPEED7 is a registered trademark of profichip GmbH.

SIMATIC, STEP, SINEC, TIA Portal, S7-300 and S7-400 are registered trademarks of Siemens AG.

Microsoft und Windows are registered trademarks of Microsoft Inc., USA.

Portable Document Format (PDF) and Postscript are registered trademarks of Adobe Systems, Inc.

All other trademarks, logos and service or product marks specified herein are owned by their respective companies.

## **Information product support**

Contact your local VIPA Customer Service Organization representative if you wish to report errors or questions regarding the contents of this document. If you are unable to locate a customer service center, contact VIPA as follows:

VIPA GmbH, Ohmstraße 4, 91074 Herzogenaurach, Germany

Telefax: +49 9132 744 1204  
EMail: [documentation@vipa.de](mailto:documentation@vipa.de)

## **Technical support**

Contact your local VIPA Customer Service Organization representative if you encounter problems with the product or have questions regarding the product. If you are unable to locate a customer service center, contact VIPA as follows:

VIPA GmbH, Ohmstraße 4, 91074 Herzogenaurach, Germany

Telephone: +49 9132 744 1150 (Hotline)  
EMail: [support@vipa.de](mailto:support@vipa.de)

## Contents

<b>About this manual .....</b>	<b>1</b>
<b>Safety information .....</b>	<b>2</b>
<b>Chapter 1 Basics .....</b>	<b>1-1</b>
Safety information for users .....	1-2
System conception .....	1-3
Basics PROFIBUS .....	1-5
<b>Chapter 2 Assembly and installation guidelines.....</b>	<b>2-1</b>
Assembly possibilities.....	2-2
Installation guidelines .....	2-3
PROFIBUS installation guidelines .....	2-6
<b>Chapter 3 Hardware description .....</b>	<b>3-1</b>
Properties.....	3-2
Structure .....	3-3
Technical data.....	3-5
<b>Chapter 4 Deployment .....</b>	<b>4-1</b>
Fast introduction.....	4-2
Power supply.....	4-4
Installation .....	4-5
Project engineering DP slave .....	4-6
DP-V0 slave parameterization .....	4-7
DP-V1 slave parameterization .....	4-9
Configure DP slave .....	4-12
Determine rack periphery address .....	4-14
Hardware configuration - S5 modules .....	4-16
DP-V1 - Services.....	4-20
Diagnostic functions .....	4-21
Firmware update .....	4-26



## About this manual

This manual describes the VIPA IM 306-1UE00 DP-Slave for the AG-135U/155U. Here you may find every information for commissioning and operation.

### Overview

#### **Chapter 1: Basics**

With this basics you get hints for the usage of the module. After the description of the system conception you get basics concerning PROFIBUS DP-V1.

#### **Chapter 2: Assembly and installation guidelines**

In this chapter you will find all information, required for the installation and the PROFIBUS cabling.

#### **Chapter 3: Hardware description**

Here the hardware components of the IM 306 DP slave are more described. The technical data may be found at the end of this chapter.

#### **Chapter 4: Deployment**

This chapter describes the deployment of the IM 306 DP Slave. With the fast introduction you get a fast overview of the approach to convert your Siemens S5 PLC to S7. The steps of the fast introduction are more described at the following pages.

Further the DP-V1 services and the diagnostics possibilities with PROFIBUS are specified.

There is the possibility to establish a firmware update at the module. For this the approach may be found at the end of this chapter..

**Objective and contents**

This manual describes the VIPA IM 306-1UE00 DP-Slave for the AG-135U/155U. It contains a description of the construction, project implementation and usage.

This manual is part of the documentation package with order number HB37E\_IM and relevant for:

Product	Order number	as of state:	
		HW	FW
IM 306 DP slave 135U/155U EG	VIPA 306-1UE00	01	V1.0.6

**Target audience**

The manual is targeted at users who have a background in automation technology.

**Structure of the manual**

The manual consists of chapters. Every chapter provides a self-contained description of a specific topic.

**Guide to the document**

The following guides are available in the manual:

- an overall table of contents at the beginning of the manual
- an overview of the topics for every chapter

**Availability**

The manual is available in:

- printed form, on paper
- in electronic form as PDF-file (Adobe Acrobat Reader)

**Icons Headings**

Important passages in the text are highlighted by following icons and headings:



**Danger!**

Immediate or likely danger.  
Personal injury is possible.



**Attention!**

Damages to property is likely if these warnings are not heeded.



**Note!**

Supplementary information and useful tips.

## Safety information

### Applications conforming with specifications

The IM 306-1UE00 DP slave is constructed and produced for:

- deployment at the IM slot of an AG-135U/155U
- communication and process control
- general control and automation applications
- industrial applications
- operation within the environmental conditions specified in the technical data
- installation into a cubicle



### Danger!

This device is not certified for applications in

- in explosive environments (EX-zone)

### Documentation

The manual must be available to all personnel in the

- project design department
- installation department
- commissioning
- operation



### The following conditions must be met before using or commissioning the components described in this manual:

- Hardware modifications to the process control system should only be carried out when the system has been disconnected from power!
- Installation and hardware modifications only by properly trained personnel.
- The national rules and regulations of the respective country must be satisfied (installation, safety, EMC ...)

### Disposal

**National rules and regulations apply to the disposal of the unit!**





## Chapter 1 Basics

**Overview** With this basics you get hints for the usage of the module.  
After the description of the system conception you get basics concerning PROFIBUS DP-V1.

<b>Content</b>	<b>Topic</b>	<b>Page</b>
	<b>Chapter 1 Basics .....</b>	<b>1-1</b>
	Safety information for users .....	1-2
	System conception .....	1-3
	Basics PROFIBUS .....	1-5

## Safety information for users

### Handling of electrostatic sensitive modules

VIPA modules make use of highly integrated components in MOS-technology. These components are extremely sensitive to over-voltages that can occur during electrostatic discharges.

The following symbol is attached to modules that can be destroyed by electrostatic discharges:



The symbol is located on the module, the module rack or on packing material and it indicates the presence of electrostatic sensitive equipment.

It is possible that electrostatic sensitive equipment is destroyed by energies and voltages that are far less than the human threshold of perception. These voltages can occur where persons do not discharge themselves before handling electrostatic sensitive modules and they can damage components thereby, causing the module to become inoperable or unusable. Modules that have been damaged by electrostatic discharges may fail after a temperature change, mechanical shock or changes in the electrical load.

Only the consequent implementation of protection devices and meticulous attention to the applicable rules and regulations for handling the respective equipment can prevent failures of electrostatic sensitive modules.

### Shipping of electrostatic sensitive modules

Modules have to be shipped in the original packing material.

### Measurements and alterations on electrostatic sensitive modules

When you are conducting measurements on electrostatic sensitive modules you should take the following precautions:

- Floating instruments must be discharged before use.
- Instruments must be grounded.

Modifying electrostatic sensitive modules you should only use soldering irons with grounded tips.



### Attention!

Personnel and instruments should be grounded when working on electrostatic sensitive modules.

## System conception

**Field of application**

With the deployment of this module existing PLC-System of the AG-135U/155U series may be changed step by step to Siemens S7.

Here each central controller respectively expansion unit is connected via PROFIBUS to a subordinate master system by means of the IM 306 DP slave.

Since you have to replace your CPU respectively IM interface connection by the IM 306 DP slave, a new wiring of the I/O periphery is not necessary.

For the AG-135U/155U the following IM 306 DP slaves from VIPA are possible:

Order number	Deployment at ...	interrupt capability
VIPA 306-1UZ00	... AG-135U/155U CPU slot	yes
VIPA 306-1UE00	... AG-135U/155U IM slot	no

**In principle is valid**

- Each AG-135U/155U is treated as a central controller, which is to be connected via PROFIBUS to a subordinate master system by means of the IM 306 DP slave.
- In each rack besides the IM 306 DP slave only digital respectively analog modules are allowed. No further IM interface connections are permitted.
- Due to the data transfer via PROFIBUS maximally 244byte of input data and 244byte of output data may be transferred.
- The interrupt capability is only supported by deployment of the Module with order number 306-1UZ00.

**Deployment IM 306-1UE00 (no interrupt capability)**

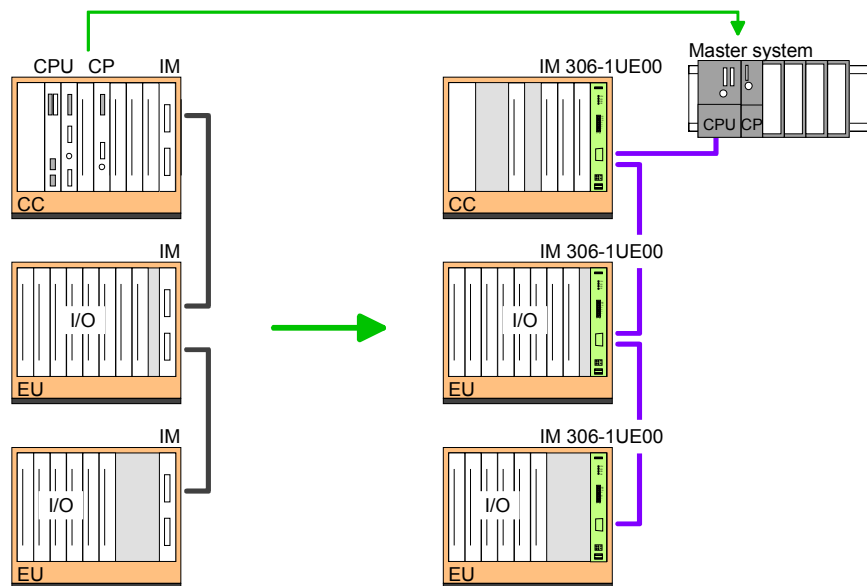

Deployment  
IM 306-1UZ00  
IM 306-1UE00  
(interrupt capability)

If you want the support of modules with interrupt capability, this structure is to be used:

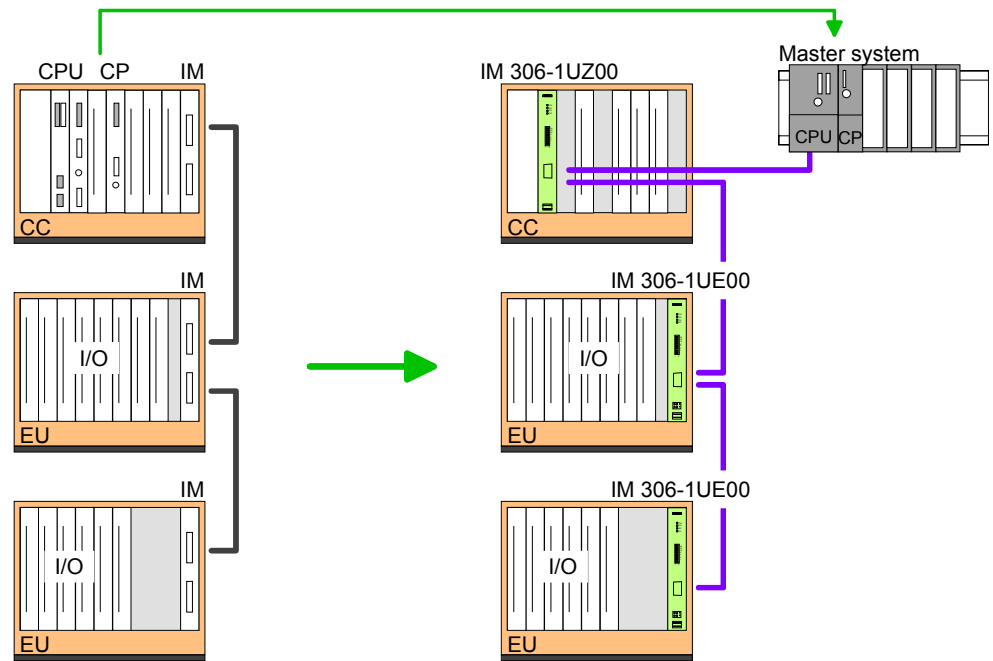

## Basics PROFIBUS

### General

PROFIBUS is an international standard applicable to an open field bus for building, manufacturing and process automation. PROFIBUS defines the technical and functional characteristics of a serial field bus system that can be used to create a low (sensor-/actuator level) or medium (process level) performance network of programmable logic controllers.

Together with other field bus systems, PROFIBUS has been standardized in **IEC 61158** since 1999. *IEC 61158* bears the title "Digital data communication for measurement and control - Field bus for use in industrial control systems".

PROFIBUS comprises an assortment of compatible versions. The following details refer to PROFIBUS DP.

### PROFIBUS DP-V0

PROFIBUS DP-V0 (**D**ecentralized **P**eripherals) provides the basic functionality of DP, including cycle data exchange as well as station diagnostic, module diagnostic and channel-specific diagnostic.

PROFIBUS DP is a special protocol intended mainly for automation tasks in a manufacturing environment. DP is very fast, offers plug'n'play facilities and provides a cost-effective alternative to parallel cabling between PLC and remote I/O. PROFIBUS DP was designed for high-speed cyclical data communication between bus master and slave systems.

### PROFIBUS DP-V1

The original version, designed DP-V0, has been expanded to include version DP-V1, offering acyclic data exchange between master and slave.

*DP-V1* contains enhancements geared towards process automation, in particular acyclic data communication for parameter assignment, operation, visualization and alarm handling of intelligent field devices, parallel to cycle user data communication. This permits online access to station using engineering tools. In addition, DP-V1 defines alarms. Examples for different types of alarms are status alarm, update alarm and a manufacturer-specific alarm.

Please note in operating the DP V1 functionality that your DP master supports DP-V1 as well. For this you find details in the documentation to your DP master.

**Master and slaves** PROFIBUS distinguishes between active stations (master) and passive stations (slave).

*Master devices*

Master devices control the data traffic at the bus. It is also possible to operate with multiple masters on a PROFIBUS. This is referred to as multi-master operation. The protocol on the bus establishes a logical token ring between intelligent devices connected to the bus. Only the master, which that has the token, can communicate with its slaves.

A master is able to issue unsolicited messages if it is in possession of the access key (token). The PROFIBUS protocol also refers to masters as active participants.

*Slave devices*

A PROFIBUS slave acquires data from peripheral equipment, sensors, actuators and transducers. The PROFIBUS couplers are modular slave devices, which transfer data between linked periphery and the high-level master.

In accordance with the PROFIBUS standards these devices have no bus-access rights. They are only allowed to acknowledge messages or return messages to a master when this has issued a request. Slaves are also referred to as passive participants.

**Master class 1  
MSAC\_C1**

The master of the class 1 is a central control that exchanges cyclically information with the decentral stations (slaves) in a defined message cycle. Typical MSAC\_C1 devices are controls (PLC) or PCs. MSAC\_C1 devices gain active bus access, which allows them to read the measuring values (inputs) of the field devices and to write the set points (outputs) of the actuators at a fixed time.

**Master class 2  
MSAC\_C2**

MSAC\_C2 are employed for service and diagnostic. Here connected devices may be configured, measuring values and parameters are evaluated and device states can be requested. MSAC\_C2 devices don't need to be connected to the bus system permanently. These also have active bus access.

Typical MSAC\_C2 devices are engineering, project engineering or operator devices.

---

**Communication**

The bus transfer protocol provides two alternatives for the access to the bus:

**Master with master**

Master communication is also referred to as token-passing procedure. The token-passing procedure guarantees the accessibility of the bus. The permission to access the bus is transferred between individual devices in the form of a "token". The token is a special message that is transferred via the bus.

When a master is in possession of the token it has the permission to access the bus and it can communicate with any active or passive device. The token retention time is defined when the system is configured. Once the token retention time has expired, the token is passed to the following master which now has permission to access the bus and may therefore communicate with any other device.

**Master-slave procedure**

Data communication between a master and the slaves assigned to it, is conducted automatically in a predefined and repetitive cycle by the master. You assign a slave to a specific master when you define the project. You can also define which DP slaves are included and which are excluded from the cyclic exchange of data.

Data communication between master and slave can be divided into a parameterization, a configuration and a data transfer phase. Before a DP slave is included in the data transfer phase the master checks whether the defined configuration corresponds with the actual configuration. This check is performed during the definition and configuration phase. The verification includes the device type, format and length information as well as the number of inputs and outputs. In this way a reliable protection from configuration errors is achieved.

The master handles the transfer of application related data independently and automatically. You can, however, also send new configuration settings to a bus coupler.

When the status of the master is DE "Data Exchange" it transmits a new series of output data to the slave and the reply from the slave contains the latest input data.

**Data consistency**

Consistent data is the term used for data that belongs together by virtue of its contents. This is the high and the low byte of an analog value (word consistency) as well as the control and status byte along with the respective parameter word for access to the registers.

The data consistency as applicable to the interaction between the periphery and the controller is only guaranteed for 1Byte. This means that input and output of the bits of a byte occurs together. This byte consistency suffices when digital signals are being processed.

Where the data length exceeds a byte, for example in analog values, the data consistency must be extended.

**Restrictions**

- Max. 125 DP slaves at one DP master - max. 32 slaves/segment.
- You can only install or remove peripheral modules when you have turned the power off!
- The max. distance for RS485 cables between two stations is 1200m (depending on the baud rate).
- The maximum baud rate is 12Mbaud.
- The PROFIBUS address of operational modules must never be changed.

**Diagnostic**

PROFIBUS DP provides an extensive set of diagnostic functions for fast error localization. Diagnostic messages are transferred via the bus and collected by the master.

**Function cyclic data communication (DP-V0)**

DP-V0 provides the basic functionality of DP, including cycle data exchange as well as station diagnostic, module diagnostic and channel-specific diagnostic.

Data is transferred cyclically between the DP master and the DP slave by means of transmit and receive buffers.

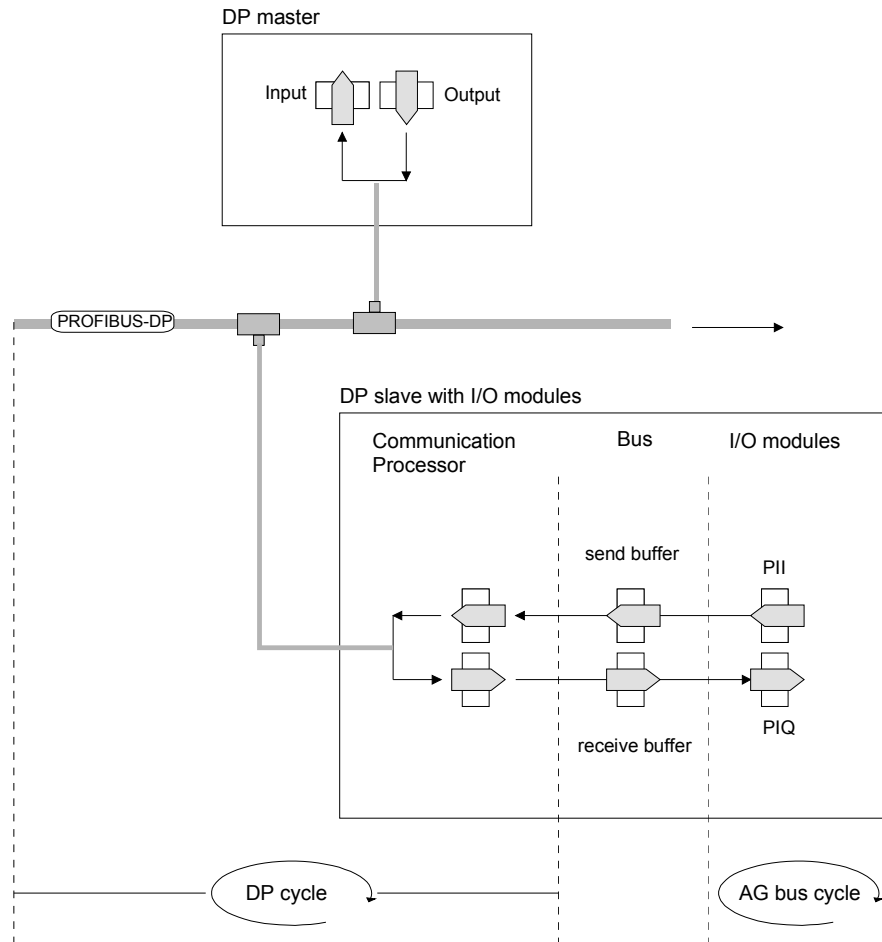

PII: process image of the inputs  
 PIQ: process image of the outputs



**Function**  
**Acyclic data communication (DP-V1)**

The key feature of version DP-V1 is the extended function for acyclic data communication. This forms the requirement for parameterization and calibration of the field devices over the bus during runtime and for the introduction of confirmed alarm messages.

Transmission of acyclic data is executed parallel to cycle data communication, but with lower priority.

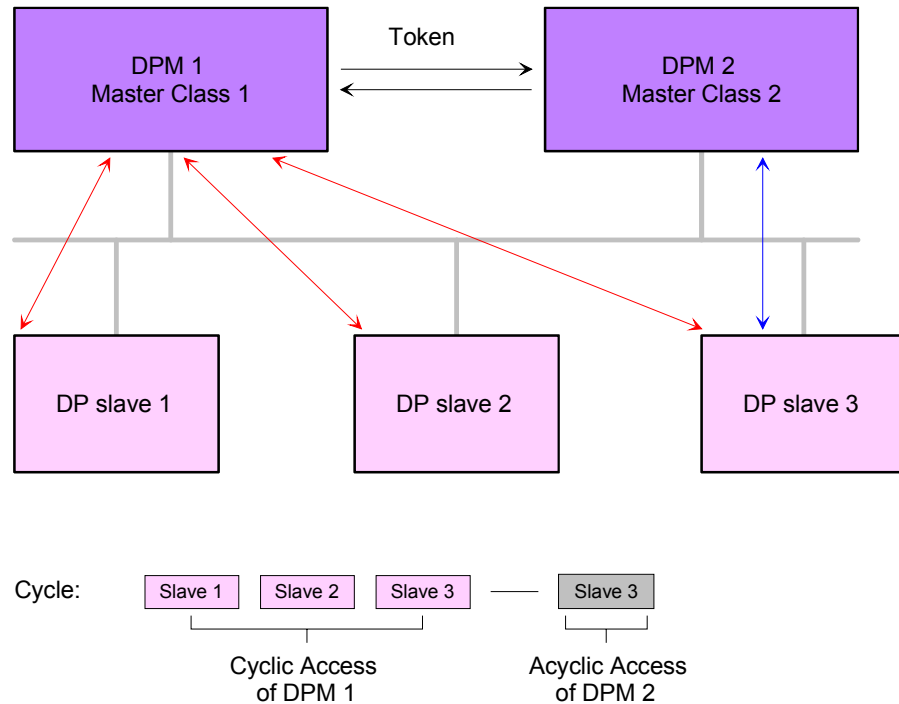

The DPM 1 (Master Class 1) has the token and is able to send messages to or retrieve them from slave 1, then slave 2, etc. in a fixed sequence until it reaches the last slave of the current list (MS0 channel); it then passes on the token to the DPM 2 (Master Class 2). This master can then use the remaining available time ("gap") of the programmed cycle to set up an acyclic connection to *any* slave (e.g. slave 3) to exchange records (MS2 channel); at the end of the current cycle time it returns the token to the DPM1.

The acyclic exchange of records can last for several scan cycles on their "gaps"; at the end, the DPM 2 uses the gap to clear the connection. Similarly as well as the DPM 2, the DPM 1 can also execute acyclic data exchange with slaves (MS1 channel).

**Addressing with Slot and Index**

When addressing data, PROFIBUS assumes that the physical structure of the slaves is *modular* or it can be structured internally in logical functional units, so-called *modules*. This model is also used in the basic DP functions for cyclic data communication where each module has a constant number of input-/output bytes that are transmitted in a fixed position in the user data telegram. The addressing procedure is based on identifiers, which characterize a module type as input, output or a combination of both. All identifiers combined produce the *configuration* of the slave, which is also checked by the DPM when the system starts up.

The acyclic data communication is also based on this model. All data blocks enabled for read/write access are also regarded as assigned to the modules and can be addressed using slot number and index.

The *Slot\_Number* addresses the module and the *index* addresses the data blocks of a module. The Slot\_Number = 0 addresses data of the PROFIBUS coupler, Slot\_Number > 0 addresses the data of the function modules.

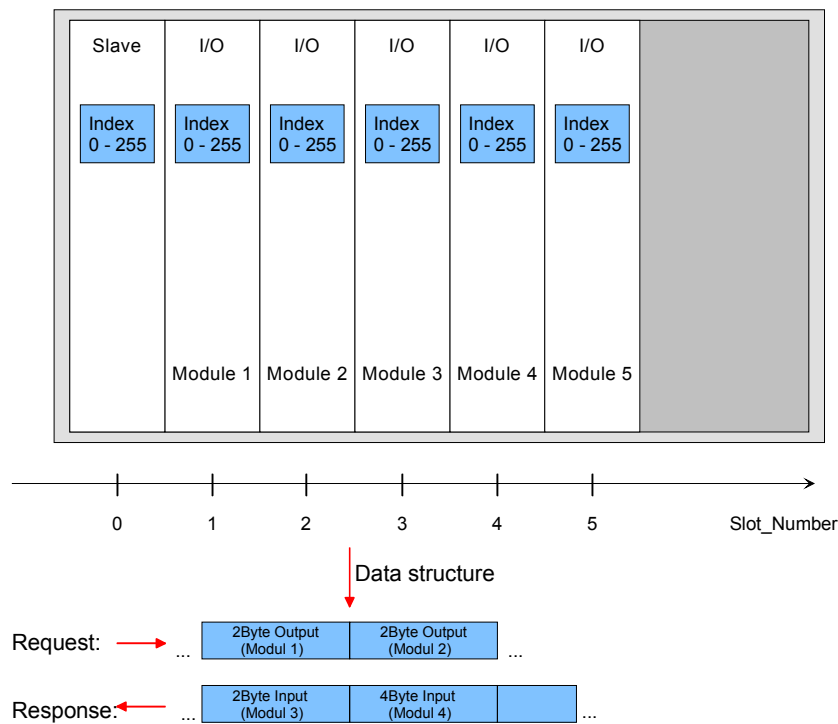

Each data block can be up to 244bytes. In the case of modular devices, the slot number is assigned to the modules. Compact devices are regarded as a unit of virtual modules. These can also be addressed with slot number and index. Through the length specification in the read/write request, it is also possible to read/write parts of a data block.



**Note!**

For the addressing at the deployment of the Siemens SIMATIC manager the following conventions are valid:

DP slave coupler: Setting of the *diagnostic address* as ID.

Modules of the DP slave coupler: Setting of the *module address* as ID. For an output module you have to set additionally bit 15 of the module address (e.g. address 0004h becomes 8004h). With a combination module you have to set the lower one of the two addresses.

**Services  
Acyclic data  
communication**

Additional available services are shown in following table.

More detailed information to the services and the DP-V0/1 communication - principles is to find in the PROFIBUS norm IEC 61158.

DPM 1 (MSAC-C1)

Services for Acyclic data communication between the DPM 1 and Slaves	
Read	The master reads a data block from the slave.
Write	The master writes a data block to the slave.
Alarm	An alarm is transmitted from the slave to the master, which explicitly acknowledges receipt. The slave can only send a new alarm message after it has received this acknowledgment; this prevents any alarms being overwritten.
Alarm_Acknowledge	The master acknowledges receipt of an alarm to the slave.
Status	A status message is transmitted from the slave to the master. There is no acknowledgment.
Data transmission is connection-oriented over a MS1 connection. This is set up by the DPM 1 and is closely linked to the connection for cyclic data communication. It can be used by the master, which has parameterized and configured the respective slave.	

DPM 2 (MSAC-C2)

Services for Acyclic data communication between the DPM 2 and Slaves	
Initiate Abort	Setup and termination of a connection for acyclic data communication between the DPM 2 and the Slave
Read	The master reads a data block from the slave.
Write	The master writes a data block to the slave.
Data_Transport	The master can write application-specific data (specified in profiles) acyclically to the slave and if required, read data from the slave in the same cycle.
Data transmission is connection-oriented over a MS2 connection. This is set up before the start of the acyclic data communication by the DPM 2 using the Initiate service. The connection is then available for Read, Write and Data_Transport services. The connection is terminated correspondingly. A slave can maintain several active MS2 connections simultaneously. A limitation is given by the resources available in the slave.	

---

### RS485 interface as data transfer medium

PROFIBUS employs screened twisted pair cable on the basis of the RS485 interface. The data transfer rate of the system is limited to a max. of 12Mbaud.

The RS485 interface uses differential voltages. For this reason this kind of interface is less susceptible to interference than a plain voltage or current based interface. The network may be configured as linear or as tree structure. Your PROFIBUS coupler carries a 9pin socket. This socket is used to connect the PROFIBUS coupler to the PROFIBUS network as a slave.

Due to the bus structure of RS485, any station may be connected or disconnected without interruptions and a system can be commissioned in different stages. Extensions to the system do not affect stations that have already been commissioned. Any failures of stations or new devices are detected automatically.

---

### Addressing

Every device on the PROFIBUS is identified by an address. This address must be an unique number in the bus and with the IM 306 DP slave between 2 and 125.

At the IM 306 DP slave the PROFIBUS address may be set by the address switch located at the front side of the module. This address must be assigned during hardware configuration of the master system in the properties dialog of the slave system.

---

### GSD file

For the IM 306 DP slave there are GSD files available from VIPA. These may be downloaded from the "Service" area of [www.vipa.com](http://www.vipa.com).

The IM 306 DP slave may be configured as DP-V0 or as DP-V1 slave. Each slave type has its own GSD file.

The assignment of the slave type is shown in the following table:

IM 306-1UE00

Slave type	GSD file
DP-V0	VI300BB4.GSD
DP-V1	VI310BB4.GSD

Please install the required files in your configuration tool. Details on the installation of the GSD files are available from the manual supplied with your configuration tool.

After the installation of the GSD file the IM 306 DP slave may be found in the hardware catalog from Siemens at:

*Profibus DP > Additional field devices > I/O > VIPA\_306\_1XX00*

## Chapter 2 Assembly and installation guidelines

**Overview** In this chapter you will find all information, required for the installation and the PROFIBUS cabling.

<b>Content</b>	<b>Topic</b>	<b>Page</b>
	<b>Chapter 2 Assembly and installation guidelines</b> .....	<b>2-1</b>
	Assembly possibilities.....	2-2
	Installation guidelines .....	2-3
	PROFIBUS installation guidelines .....	2-6

## Assembly possibilities

### Slots

The module IM 306-1UE00 may be used with an AG-135U/155U and here exclusively at an IM slot. Interrupts of modules with interrupt capability are not supported.

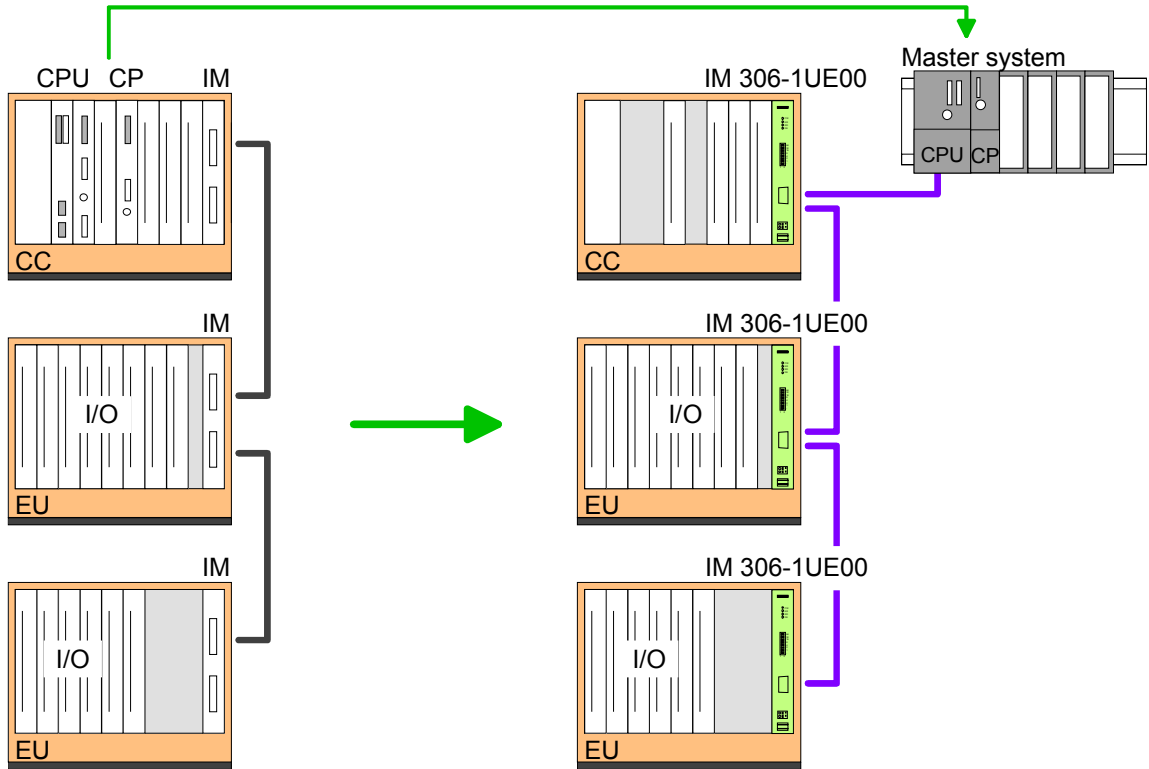

Slots in the AG-135U/155U

In the following for the IM 306-1UE00 DP slave the possible slots at the racks are shown. Possible positions are identified by X .

Slot	3	11	19	27	35	43	51	59	67	75	83	91	99	107	115	123	131	139	147	155	163		
ZG-135U																						X	
ZG-188U																							X
EG-183U																							X
EG-184U																							X
EG-185U																							X
EG-187U																							X



### Note!

If you want interrupt capability, you have to use the module IM 306-1UZ00. This exclusively may be used in the central controller and here only at the CPU slot.

## Installation guidelines

<b>General</b>	<p>The installation guidelines contain information about the interference free deployment of System SLIO. There is the description of the ways, interference may occur in your control, how you can make sure the electromagnetic digestibility (EMC), and how you manage the isolation.</p>
<b>What means EMC?</b>	<p>Electromagnetic digestibility (EMC) means the ability of an electrical device, to function error free in an electromagnetic environment without being interferenced res. without interfering the environment.</p> <p>All System SLIO components are developed for the deployment in industrial environments and fulfill high demands on the EMC. Nevertheless you should project an EMC planning before installing the components and take conceivable interference causes into account.</p>
<b>Possible interference causes</b>	<p>Electromagnetic interferences may interfere your control via different ways:</p> <ul style="list-style-type: none"><li>• Electromagnetic fields (RF coupling)</li><li>• Magnetic fields with power frequency</li><li>• I/O signal conductors</li><li>• Bus system</li><li>• Current supply</li><li>• Protected earth conductor</li></ul> <p>Depending on the spreading medium (lead bound or lead free) and the distance to the interference cause, interferences to your control occur by means of different coupling mechanisms.</p> <p>One differs:</p> <ul style="list-style-type: none"><li>• galvanic coupling</li><li>• capacitive coupling</li><li>• inductive coupling</li><li>• radiant coupling</li></ul>

**Basic rules for EMC**

In the most times it is enough to take care of some elementary rules to guarantee the EMC. Please regard the following basic rules when installing your PLC.

- Take care of a correct area-wide grounding of the inactive metal parts when installing your components.
  - Install a central connection between the ground and the protected earth conductor system.
  - Connect all inactive metal extensive and impedance-low.
  - Please try not to use aluminum parts. Aluminum is easily oxidizing and is therefore less suitable for grounding.
- When cabling, take care of the correct line routing.
  - Organize your cabling in line groups (high voltage, current supply, signal and data lines).
  - Always lay your high voltage lines and signal res. data lines in separate channels or bundles.
  - Route the signal and data lines as near as possible beside ground areas (e.g. suspension bars, metal rails, tin cabinet).
- Proof the correct fixing of the lead isolation.
  - Data lines must be laid isolated (for details see below).
  - Analog lines must be laid isolated. When transmitting signals with small amplitudes the one sided laying of the isolation may be favorable.
  - Lay the line isolation extensively on an isolation/protected earth conductor rail directly after the cabinet entry and fix the isolation with cable clamps.
  - Make sure that the isolation/protected earth conductor rail is connected impedance-low with the cabinet.
  - Use metallic or metalized plug cases for isolated data lines.
- In special use cases you should appoint special EMC actions.
  - Wire all inductivities with erase links, which are not addressed by the System SLIO modules.
  - For lightening cabinets you should avoid luminescent lamps.
- Create a homogeneous reference potential and ground all electrical operating supplies when possible.
  - Please take care for the targeted employment of the grounding actions. The grounding of the PLC is a protection and functionality activity.
  - Connect installation parts and cabinets with the System SLIO in star topology with the isolation/protected earth conductor system. So you avoid ground loops.
  - If potential differences between installation parts and cabinets occur, lay sufficiently dimensioned potential compensation lines.



**Isolation of conductors**

Electrical, magnetically and electromagnetic interference fields are weakened by means of an isolation, one talks of absorption.

Via the isolation rail, that is connected conductive with the rack, interference currents are shunt via cable isolation to the ground. Hereby you have to make sure, that the connection to the protected earth conductor is impedance-low, because otherwise the interference currents may appear as interference cause.

When isolating cables you have to regard the following:

- If possible, use only cables with isolation tangle.
- The hiding power of the isolation should be higher than 80%.
- Normally you should always lay the isolation of cables on both sides. Only by means of the both-sided connection of the isolation you achieve high quality interference suppression in the higher frequency area.  
Only as exception you may also lay the isolation one-sided. Then you only achieve the absorption of the lower frequencies. A one-sided isolation connection may be convenient, if:
  - the conduction of a potential compensating line is not possible
  - analog signals (some mV res.  $\mu\text{A}$ ) are transferred
  - foil isolations (static isolations) are used.
- With data lines always use metallic or metalized plugs for serial couplings. Fix the isolation of the data line at the plug rack. Do not lay the isolation on the PIN 1 of the plug bar!
- At stationary operation it is convenient to strip the insulated cable interruption free and lay it on the isolation/protected earth conductor line.
- To fix the isolation tangles use cable clamps out of metal. The clamps must clasp the isolation extensively and have well contact.
- Lay the isolation on an isolation rail directly after the entry of the cable in the cabinet. Lead the isolation further on to the System SLIO module and **don't** lay it on there again!

**Please regard at installation!**

At potential differences between the grounding points, there may be a compensation current via the isolation connected at both sides.

Remedy: Potential compensation line

## PROFIBUS installation guidelines

### PROFIBUS in general

- A PROFIBUS DP network may only be built up in linear structure.
- PROFIBUS DP consists of minimum one segment with at least one master and one slave.
- A master is always to be deployed together with a CPU.
- PROFIBUS supports max. 126 participants.
- Per segment a max. of 32 participants is permitted.
- The max. segment length depends on the baud rate:
 

9.6 ... 187.5kBaude	→	1000m
500kBaude	→	400m
1.5Mbaude	→	200m
3 ... 12Mbaude	→	100m
- Max. 10 segments may be built up. The segments are connected via repeaters. Every repeater counts for one participant.
- All participants are communicating with the same baudrate. The slaves adjust themselves automatically on the baudrate.
- The bus has to be terminated at both ends.
- Master and slaves are free combinable.

### Transfer medium

As transfer medium PROFIBUS uses an isolated twisted-pair cable based upon the RS485 interface.

The RS485 interface is working with voltage differences. Though it is less irritable from influences than a voltage or a current interface. You are able to configure the network as well linear as in a tree structure.

At the front side of the module there is a 9pin jack designated as "PB-DP", By means of this jack your PROFIBUS coupler is directly connected as slave to your PROFIBUS network.

Max. 32 participants per segment are permitted. The segments are connected via repeaters. The maximum segment length depends on the transfer rate.

PROFIBUS DP uses a transfer rate between 9.6kbaud and 12Mbaud, the slaves are following automatically. All participants are communicating with the same baudrate.

The bus structure under RS485 allows an easy connection res. disconnection of stations as well as starting the system step by step. Later expansions don't have any influence on stations that are already integrated. The system realizes automatically if one partner had a fail down or is new in the network.

**Bus connection**

The following picture illustrates the terminating resistors of the respective start and end station.

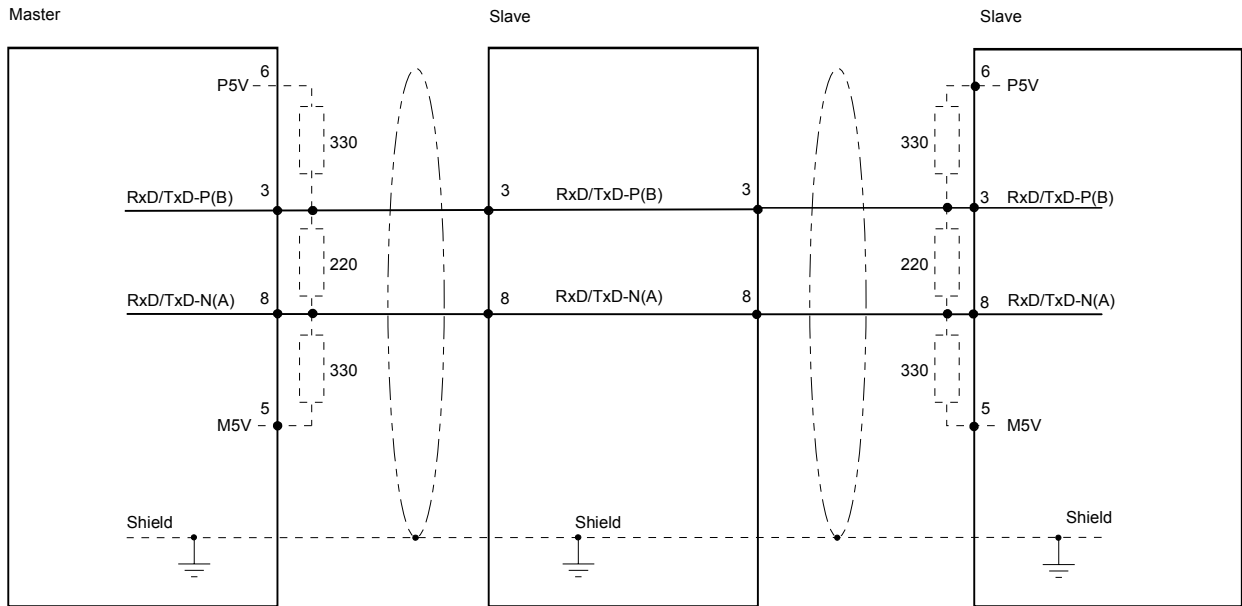

**Note!**

The PROFIBUS line has to be terminated with its ripple resistor. Please make sure to terminate the last participants on the bus at both ends by activating the terminating resistor.

**EasyConn bus connector**



In PROFIBUS all participants are wired parallel. For that purpose, the bus cable must be feed-through.

Via the order number VIPA 972-0DP10 you may order the bus connector "EasyConn". This is a bus connector with switchable terminating resistor and integrated bus diagnostic.

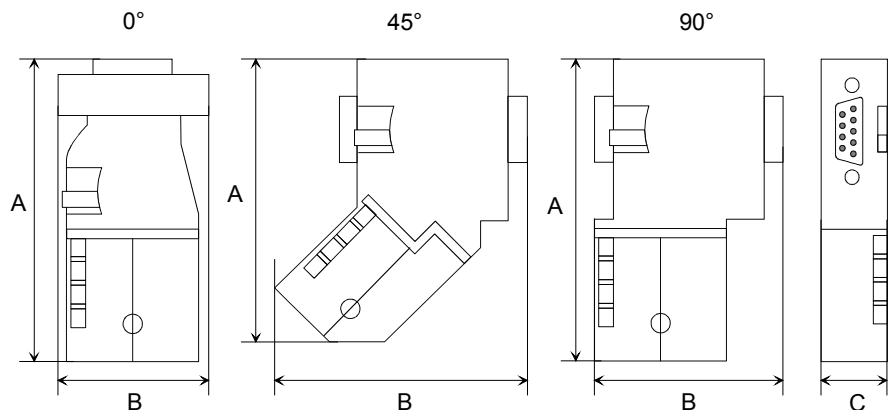

	0°	45°	90°
A	64	61	66
B	34	53	40
C	15.8	15.8	15.8

all in mm



**Note!**

To connect this EasyConn plug, please use the standard PROFIBUS cable type A (EN50170). Starting with release 5 you also can use highly flexible bus cable: Lapp Kabel order no.: 2170222, 2170822, 2170322. Under the order no. 905-6AA00 VIPA offers the "EasyStrip" de-isolating tool that makes the connection of the EasyConn much easier.



Dimensions in mm

Termination with "EasyConn"

The "EasyConn" bus connector is provided with a switch that is used to activate a terminating resistor.

Wiring

1./last bus participant

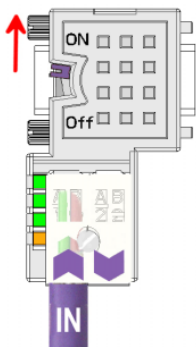

further participants

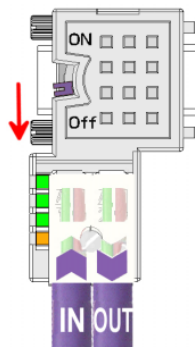

**Attention!**

The terminating resistor is only effective, if the connector is installed at a bus participant and the bus participant is connected to a power supply.

**Note!**

A complete description of installation and deployment of the terminating resistors is delivered with the connector.

Assembly

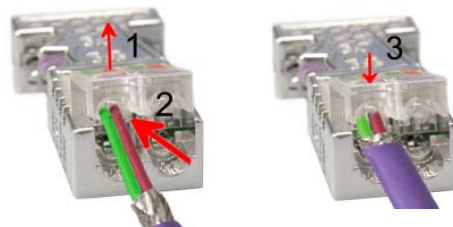

- Loosen the screw.
- Lift contact-cover.
- Insert both wires into the ducts provided (watch for the correct line color as below!)
- Please take care not to cause a short circuit between screen and data lines!
- Close the contact cover.
- Tighten screw (max. tightening torque 4Nm).

**Please note:**

The green line must be connected to A, the red line to B!

## Chapter 3 Hardware description

**Overview** Here the hardware components of the IM 306 DP slave are more described. The technical data may be found at the end of this chapter.

<b>Content</b>	<b>Topic</b>	<b>Page</b>
	<b>Chapter 3 Hardware description .....</b>	<b>3-1</b>
	Properties.....	3-2
	Structure .....	3-3
	Technical data.....	3-5

## Properties

### IM 306-1UE00

- Converting Siemens S5 PLCs to S7
- Exclusively suited for AG-135U/155U central controller and expansion units
- Supports digital and analog I/O modules
- PROFIBUS DP slave 9,6kbaud up to 12Mbaud
- Supports PROFIBUS DP-V0 and DP-V1
- Max. 244byte input data and 244byte output data
- LEDs for bus diagnostics
- Integrated DC 24V power supply to supply the back plane bus if necessary



### Ordering data

Type	Order number	Description
IM 306	VIPA 306-1UE00	DP slave for IM slots in the AG-135U/155U

## Structure

### IM 306-1UE00

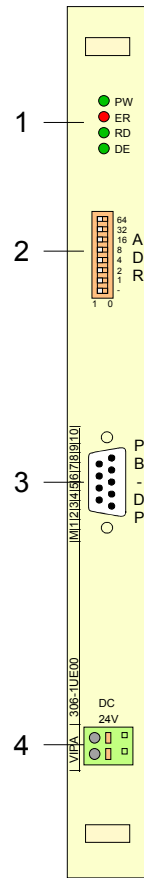

- [1] LED status display
- [2] Address switch
- [3] RS485 interface
- [4] Jack for DC 24V power supply

### LEDs

The IM 306 DP slave has a number of LEDs, which are available for diagnostic purposes on the bus and for displaying the local state. With the following scheme they inform about the operating state of the DP Slave:

PW green	ER red	RD green	DE green	Meaning
●	○	○	○	Module is power supplied. Slave has no project.
●	●	○	○	Error in configuration. QVZ occurred.
●	☀	○	○	Initialization error
●	☀	☀	○	Blinks alternately at faulty project of the master.
●	☀	☀	○	Blinks simultaneously at faulty parameters.
●	○	●	●	DP slave is in state "Data Exchange".
●	○	☀	○	Positive self-test and initialization

on: ●      off: ○      blinking: ☀

**Address switch**

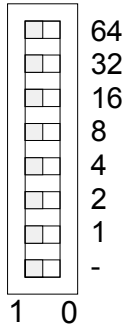

The PROFIBUS address of the slave may be adjusted by this address switch. Permitted addresses are 2 to 125.

Please regard with VIPA components the address 1 is system-dependently reserved.

Each address may only once be assigned at the bus. Before the startup the PROFIBUS address is to be preset.

**RS485 interface**

The IM 306 DP slave is connected to PROFIBUS by the 9pin RS485 interface. The RS485 interface has the following pin assignment:

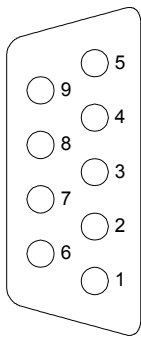

Pin	Assignment	Bus termination
1	n.c.	
2	M24V	
3	RxD/TxD-P (Line B)	
4	RTS	
5	M5V	
6	P5V	
7	P24V	
8	RxD/TxD-N (Line A)	
9	n.c.	



**Note!**

Please regard to terminate the bus at its ends by means of a terminating resistor!

**Power supply**

Depending on the used Siemens S5 rack the power supply happens via backplane bus or via the front supply.

Turn the power on, only after you have firmly fixed all modules in the rack.



**Attention!**

The power supply happens either via the backplane bus or via the front-side.

**Simultaneous infeed should absolutely be avoided.**



## Technical data

<b>Order no.</b>	<b>306-1UE00</b>
Type	IM 306 DP slave 135U/155U
<b>Technical data power supply</b>	
Power supply (rated value)	DC 24 V
Power supply (permitted range)	DC 20.4...28.8 V
Reverse polarity protection	✓
Current consumption (no-load operation)	0.1 A
Current consumption (rated value)	1 A
Inrush current	4 A
I <sup>2</sup> t	0.5 A <sup>2</sup> s
Max. current drain at backplane bus	3.5 A
Max. current drain load supply	-
Power loss	4 W
<b>Status information, alarms, diagnostics</b>	
Status display	yes
Interrupts	yes, parameterizable
Process alarm	no
Diagnostic interrupt	yes, parameterizable
Diagnostic functions	yes, parameterizable
Diagnostics information read-out	possible
Supply voltage display	green LED
Service Indicator	-
Group error display	red LED
Channel error display	none
<b>Hardware configuration</b>	
Racks, max.	1
Modules per rack, max.	18
Number of digital modules, max.	18
Number of analog modules, max.	18
<b>Communication</b>	
Fieldbus	PROFIBUS-DP to EN 50170
Type of interface	RS485 isolated
Connector	Sub-D, 9-pin, female
Topology	Linear bus with bus termination at both ends
Electrically isolated	✓
Number of participants, max.	125
Node addresses	1 - 125
Transmission speed, min.	9.6 kbit/s
Transmission speed, max.	12 Mbit/s
Address range inputs, max.	244 Byte
Address range outputs, max.	244 Byte
Number of TxPDOs, max.	-
Number of RxPDOs, max.	-
<b>Housing</b>	
Material	PC GF20
Mounting	-
<b>Mechanical data</b>	
Dimensions (WxHxD)	20 x 233.4 x 160 mm
Weight	220 g
<b>Environmental conditions</b>	
Operating temperature	0 °C to 60 °C
Storage temperature	-25 °C to 70 °C

<b>Order no.</b>	<b>306-1UE00</b>
<b>Certifications</b>	
UL508 certification	-

If the module is power supplied by backplane bus, the module has a current consumption of 400mA.

## Chapter 4 Deployment

### Overview

This chapter describes the deployment of the IM 306 DP Slave. With the fast introduction you get a fast overview of the approach to convert your Siemens S5 PLC to S7. The steps of the fast introduction are more described at the following pages.

Further the DP-V1 services and the diagnostics possibilities with PROFIBUS are specified.

There is the possibility to establish a firmware update at the module. For this the approach may be found at the end of this chapter.

### Content

Topic	Page
<b>Chapter 4 Deployment</b> .....	<b>4-1</b>
Fast introduction.....	4-2
Power supply.....	4-4
Installation .....	4-5
Project engineering DP slave .....	4-6
DP-V0 slave parameterization.....	4-7
DP-V1 slave parameterization.....	4-9
Configure DP slave .....	4-12
Determine rack periphery address.....	4-14
Hardware configuration - S5 modules.....	4-16
DP-V1 - Services.....	4-20
Diagnostic functions .....	4-21
Firmware update .....	4-26

## Fast introduction

- In principle is valid**
- The module 306-1UE00 may only be used at the IM slot of the AG-135U/155U. Here the module is to be connected via PROFIBUS to a master system.
  - In the rack besides the IM 306 DP slave at the IM slot only digital respectively analog modules are allowed.
  - Due to the data transfer via PROFIBUS maximally 244byte of input data and 244byte of output data may be transferred.
  - The interrupt capability is only supported by deployment of the module with order number 306-1UZ00.

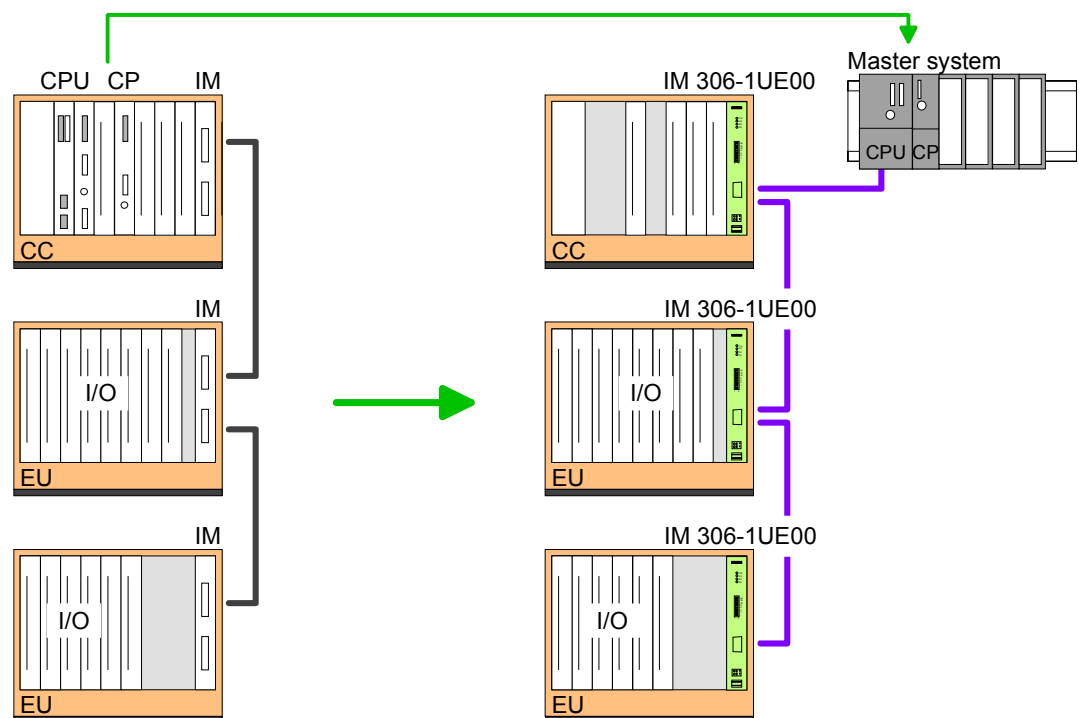

### Installation

- Isolate the AG from the supply voltage.
- Remove the cover strap of the upper locking bar, by releasing the two fixing screws.
- With exception of the digital and analog modules remove every module from the rack.
- Plug at the IM slot the IM 306-1UE00 DP slave module.
- Fix the module with its screw.
- Preset the PROFIBUS address via the DIP switch at the front. This address must be identical to the PROFIBUS address you have preset during hardware configuration.
- Fix again the cover strap of the upper locking bar with its screws.

**Power supply**

Depending on the used Siemens S5 rack the power supply happens via backplane bus or via the front supply.



**Attention!**

Please only supply the module via the front-side if there is no supply by backplane bus.

**Simultaneous infeed should absolutely be avoided.**

**Configuration**

The configuration happens as hardware configuration in the PROFIBUS DP master engineering tool by assigning the IM 306 DP slave module.

VIPA serves GSD files for the IM 306 DP slave. These may be downloaded from the "Service area" of [www.vipa.com](http://www.vipa.com). The IM 306 DP slave may be configured as DP-V0 or as DP-V1 slave. There is a GSD file for each type.

The assignment to the slave type is shown at the following table:

GSD file

Slave type	GSD file
DP-V0	VI300BB4.GSD
DP-V1	VI310BB4.GSD

By installing the corresponding GSD file the IM 306 DP slave is listed as "VIPA 306-1UE00 (DPVx) at:

*PROFIBUS-DP > Additional Field Devices > I/O > VIPA\_306\_1XX00*

Proceeding

- Install your PROFIBUS system.
- Start your project engineering tool with a new project.
- Configure a master system and create a new PROFIBUS subnet.
- For the project engineering of the IM 306 DP-Slave choose the corresponding "VIPA 306-1UE00 (DPVx)" from the hardware catalog, according to the functionality you want, and pull it to the DP master subnet.
- Enter at properties of the DP slave a PROFIBUS address between 2 and 125 and set the same address at the address switch. Please regard with VIPA system dependent the PROFIBUS address 1 is reserved.
- Parameterize the DP slave. More information may be found at "DP-Vx slave parameterization".
- Open the configuration table by clicking to the placed DP slave. In the hardware configurator starting with the 1. slot connect every module of the Siemens S5 rack with the plugged sequence of the hardware catalog. For each module enter the *Rack periphery address* and the *Periphery address* in the master system.
- Save and transfer your project to the PLC.

## Power supply

### Overview

Depending on the used Siemens S5 rack the power supply happens via backplane bus or with the integrated DC 24V power supply via front jack.

If your rack may power supply your module via backplane bus, the module automatically starts-up when snapped to the rack. Otherwise the module is to be power supplied by the internal DC 24V power supply.



### Attention!

The power supply happens either via the backplane bus or by the integrated DC 24V power supply.

**Simultaneous infeed should absolutely be avoided.**

### Cabling of the internally DC 24V power supply

If the module may power supplied by the internal DC 24V power supply, a green plug with CageClamp technology is deployed. The connection clamp is realized as plug that may be clipped off carefully if it is still cabled.

Here wires with a cross-section of 0.08mm<sup>2</sup> to 2.5mm<sup>2</sup> may be connected. You can use flexible wires without end case as well as stiff wires.

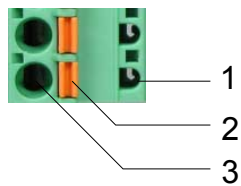
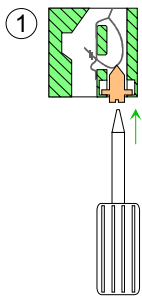

- [1] Test point for 2mm test tip
- [2] Locking (orange) for screwdriver
- [3] Round opening for wires

The picture on the left side shows the cabling step by step from top view.

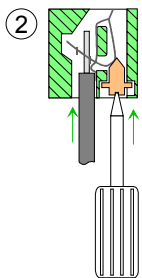

- For cabling you push the locking vertical to the inside with a suiting screwdriver and hold the screwdriver in this position.
- Insert the de-isolated wire into the round opening. You may use wires with a cross-section from 0.08mm<sup>2</sup> to 2.5mm<sup>2</sup>.
- By removing the screwdriver the wire is connected safely with the plug connector via a spring.

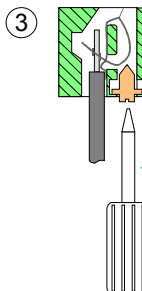

## Installation

- In principle is valid**
- The module 306-1UE00 may only be used at the IM slot of the AG-135U/155U. Here the module is to be connected via PROFIBUS to a master system.
  - In the rack besides the IM 306 DP slave at the IM slot only digital respectively analog modules are allowed.
  - Due to the data transfer via PROFIBUS maximally 244byte of input data and 244byte of output data may be transferred.
  - The interrupt capability is only supported by deployment of the module with order number 306-1UZ00.

- Proceeding**
- The installation happens with the following proceeding:
- Isolate the AG from the supply voltage.
  - Remove the cover strap of the upper locking bar, by releasing the two fixing screws.
  - With exception of the digital and analog modules remove every module from the rack.
  - Plug at the IM slot the IM 306-1UE00 DP slave module.
  - Fix the module with its screw.
  - Preset the PROFIBUS address via the DIP switch at the front. This address must be identical to the PROFIBUS address you have preset during hardware configuration.
  - Fix again the cover strap of the upper locking bar with its screws.
  - Connect the AG to the supply voltage again.

Slots in the AG-135U/155U

In the following for the IM 306-1UE00 DP slave the possible slots at the racks are shown.

Possible positions are identified by **X** .

Slot	3	11	19	27	35	43	51	59	67	75	83	91	99	107	115	123	131	139	147	155	163	
ZG-135U																						X
ZG-188U												X										X
EG-183U																						X
EG-184U																						X
EG-185U																						X
EG-187U																						X

## Project engineering DP slave

### General

For project engineering a DP master engineering tool may be used like the Siemens SIMATIC manager. Here you assign the according PROFIBUS DP slave modules to the DP master. A direct assignment takes place via the PROFIBUS address that you set at the DP slave address selector.

By installing the according GSD file the IM 306 DP slave is listed at the hardware catalog as "VIPA\_306-1UE00 [DPV...]":

*PROFIBUS DP > Additional Field devices > I/O VIPA\_306\_1XX00*

### DP-V0/DP-V1 functionality by GSD file

VIPA serves GSD files for the IM 306 DP slave. Depending on the installed GSD file the following modules are embedded to the hardware catalog:

IM 306-1UE00

Slave type	GSD file
DP-V0	VI300BB4.GSD
DP-V1	VI310BB4.GSD

Install the appropriate GSD file in your engineering tool. For more information see the manual of you engineering tool.

### Project engineering

- Mount your PROFIBUS system.
- Start your project engineering tool with a new project.
- Configure a master system and create a new PROFIBUS subnet.
- For the project engineering of the IM 306 DP slave take the "VIPA 306-1UE00 (DPVx)" for each functionality from the hardware catalog and drag it to the DP master subnet.
- Enter a PROFIBUS address between 2 and 125 into the properties of the DP slave and set the same address at the address lever.
- Parameterize the DP slave. More may be found at "DP-Vx slave parameterization".
- Configure your Siemens S5 rack. More may be found at "DP slave configuration".
- Transfer your project to the CPU.



## DP-V0 slave parameterization

### Calling the parameter dialog

Via a double-click on the placed DP-V0 slave its parameter dialog may be accessed. Here module specific data may be read or changed. In the following these parameters are described.

---

### General

#### Module

Order number  
GSD file

Order number and GSD file name of the IM 306 DP slave.

Family

Shows the DP slave family

DP slave type

As DP slave type the order number added with DPV0 is shown.

Designation

The designation is generated by the system and may be changed at any time.

#### Addresses

Diagnostic address

This is a diagnostics address generated by the system, which may be changed at any time. Failure and return of the DP slave is reported to the master by means of this address.

#### Node/ Master system

[PROFIBUS...]

The PROFIBUS interface of the DP slave may be accessed via this button. Here you may assign a PROFIBUS address to the DP slave and you may change the properties of the corresponding subnet.

If you have already assigned a PROFIBUS address to the DP slave, the address appears beside the button.

Information about the DP master system, to which your slave is connected, may be found below the button.

SYNC/FREEZE  
capabilities

The SYNC- and FREEZE control commands of the master are supported by the IM 306 DP slave from VIPA.

The DP master sends the SYNC control command to a group of DP slaves causing the DP slaves to freeze the states of their outputs at their current value.

The current state of the inputs is frozen by the *FREEZE* control command.

**Watchdog** If activated the DP slave may react on a master failure or an interruption at the bus.

*Default value: activated*

After the Watchdog expires, the DP slave leaves the state of Data Exchange (DE) and the outputs switch to "0".



**Attention!**

Please regard, if you de-activate the watchdog, the outputs of the appropriate DP slave may not be set to "0" in the event of an error.

Consequently, it is strongly recommended that the watchdog is deactivated during commissioning.

**Comment** Here the DP slave may more be commented.

---

## Parameterization

**Identifier related diagnostics** If activated (enable) information are embedded to the diagnostics data, concerning the slot (module) an error has occurred.

**Module state** If activated (enable) information are embedded to the diagnostics data, concerning the error within the module an error has occurred.

**Channel related diagnostics** If activated (enable) information are embedded to the diagnostics data, concerning the channel error within the module an error has occurred.

**DPV0: Diagnostic interrupt** If activated (enable) the diagnostics function of the DP slave is active. By deactivation the diagnostics function may be switched off.

**Data format** This parameter is only evaluated during deployment of analog modules and concerns how a value is stored in the CPU address area.

In the *Motorola-Format* (default) the bytes are stored in descending significance, this means the 1. byte contains the high byte and the 2. byte the low byte.

In the *Intel-Format* the value is turned and it is worked with ascending significance, this means the 1. byte contains the low byte and the 2. byte the high byte.

## DP-V1 slave parameterization

### Calling the parameter dialog

Via a double-click on the placed DP-V1 slave its parameter dialog may be accessed. Here module specific data may be read or changed. In the following these parameters are described.

---

### General

#### Module

Order number  
GSD file

Order number and GSD file name of the IM 306 DP slave.

Family

Shows the DP slave family.

DP slave type

As DP slave type the order number added with DPV1 is shown.

Designation

The designation is generated by the system and may be changed at any time.

#### Addresses

Diagnostic address

This is a diagnostics address generated by the system, which may be changed at any time. Failure and return of the DP slave is reported to the master by means of this address.

With DP-V1 this address is assigned to the virtual slot 0.

#### Node/ Master system

[PROFIBUS...]

The PROFIBUS interface of the DP slave may be accessed via this button. Here you may assign a PROFIBUS address to the DP slave and you may change the properties of the corresponding subnet.

If you have already assigned a PROFIBUS address to the DP slave, the address appears beside the button.

Information about the DP master system, to which your slave is connected, may be found below the button.

SYNC/FREEZE  
capabilities

The SYNC- and FREEZE control commands of the master are supported by the IM 306 DP slave from VIPA.

The DP master sends the *SYNC* control command to a group of DP slaves causing the DP slaves to freeze the states of their outputs at their current value. The current state of the inputs is frozen by the *FREEZE* control command.

**Watchdog** If activated the DP slave may react on a master failure or an interruption at the bus.

*Default value: activated*

After the Watchdog expires, the DP slave leaves the state of Data Exchange (DE) and the outputs switch to "0".



**Attention!**

Please regard, if you de-activate the watchdog, the outputs of the appropriate DP slave may not be set to "0" in the event of an error.

Consequently, it is strongly recommended that the watchdog is deactivated during commissioning.

**Comment** Here the DP slave may more be commented.

---

## Parameterization

**DP interrupt mode** Here as "DPV1" is shown as interrupt mode.

**DPV1 interrupts, general DP parameters** These parameters listed here serve exclusively for information and may not respectively must not be changed!

### Device specific parameters

**Identifier related diagnostics** If activated (enable) information are embedded to the diagnostics data, concerning the slot (module) an error has occurred.

**Module state** If activated (enable) information are embedded to the diagnostics data, concerning the error within the module an error has occurred.

**Channel related diagnostics** If activated (enable) information are embedded to the diagnostics data, concerning the channel error within the module an error has occurred.

**Data format** This parameter is only evaluated during deployment of analog modules and concerns how a value is stored in the CPU address area.

In the *Motorola-Format* (default) the bytes are stored in descending significance, this means the 1. byte contains the high byte and the 2. byte the low byte.

In the *Intel-Format* the value is turned and it is worked with ascending significance, this means the 1. byte contains the low byte and the 2. byte the high byte.

Behavior at QVZ      Here you may define, how the DP slave will behave on failure respectively on missing a module at the back plane bus.

There are the following setting options:

*Software reset, WaitPrm*  
The DP slave executes a reset and waits for parameter of the master.

*Data Exchange + BASP*  
The DP slave remains still in Data Exchange and command output disable (BASP) is activated, this means every output at the backplane bus are switched to 0.

*Data Exchange*  
The DP slave remains still in Data Exchange mode.

### **Hex parameterization**

DPV1\_Status  
(0 to 2)      Below the folder "Hex parameter assignment" the parameter data are listed in hex format.

At DPV1 slave the parameter "DPV1\_Status" is listed. This designates the bytes 0...2 of the parameter telegram, which content is preset by the system.

## Configure DP slave

### Please regard

- Please regard exclusively digital and analog modules may be configured. Other types of modules are not supported and may lead to malfunction of your system!
- For configuration refer to the current documentation of your system. Here you may find the Siemens "Rack periphery address".

### Precondition

- GSD file is installed.
- IM 306 DP slave is connected to the DP master.

### Configuration

Precondition is you have connected the IM 306 DP slave to the DP master then the configuration of the DP slave system takes place with the following approach:

- In the hardware configurator place the modules of the Siemens rack in the plugged sequence starting with the 1. slot. For this go to the Siemens hardware catalog, click at *Additional field devices > I/O > VIPA\_306\_1XX00 > VIPA 306-1...* at the corresponding DP slave and pull it from the hardware catalog to the corresponding slot. The module is placed at the corresponding slot and is assigned to a periphery address. Please regard you have to place the modules gap-free in the hardware configuration
- Open the properties dialog by double-clicking the module.
- Enter at "Address/ID" the address, by which the module is accessed by the master system.
- Change to "Parameter assignment" and enter at "Rack periphery address" the address of the module in the rack. More about this may be found on the following pages.
- Save your project.

**Configuration via I/O area**

If your module is not listed at the Siemens hardware catalog there is the possibility to use a substitution module, which corresponds to the I/O area of your module. Please consider that you may only use 1 slot for each module! A combination of these areas for one module is not possible.

**Caution!**

**Contrary to the periphery address in the master system, the allocation of the "Rack periphery address" does not take place automatically. Here always a manual address allocation is necessary (see "Hardware configuration S5 modules").**

**The "Universal module" at the Siemens hardware configurator is not supported.**

## Determine rack periphery address

**Overview** To get access with your master system to a module in the rack, the *Rack Periphery Address* of the module is to be determined and entered to the properties dialog of this module, during hardware configuration.

**Rack Periphery Address AG-135U/155U** There are the following possibilities to determine the *Rack Periphery Address*:

- Documentation of the plant
- Address switch
- Show 135U process image

**Documentation of the plant** Take the address from the documentation of your plant.

**Address switch** On each module there is an address switch. Pull the corresponding module and determine the address by means of the switch positions.

**Show 135U process image** You may configure the virtual module "Show 135U process image" as lonely module in your slave system.  
 During operation this virtual module determines each occupied address in the rack and shows this by means of a bit pattern in the set input periphery address area of the master system.  
 Here each 32byte are available for input and output modules.

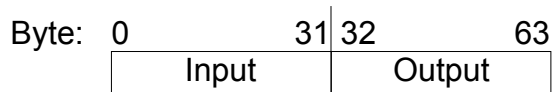

Address input module	Address output module
Byte 0 Bit 7 ... 0 → Address 0 ... 7	Byte 32 Bit 7 ... 0 → Address 0 ... 7
Byte 1 Bit 7 ... 0 → Address 8 ... 15 ....	Byte 33 Bit 7 ... 0 → Address 8 ... 15 ....
Byte 16 Bit 7 ... 0 → Address 128 ... 135 ....	Byte 48 Bit 7 ... 0 → Address 128 ... 135 ....
Byte 31 Bit 7 ... 0 → Address 248 ... 255	Byte 63 Bit 7 ... 0 → Address 248 ... 255



**Example** Variables table of the function: "Show 135U process image"

Operand	Symbol	Display format	Status value	Status value
<i>//slave 7 306-1UE00</i>				
<i>//input address range</i>				
			4 0 12 8 20 16 28 24	<b>&lt;- start address containing address bytes</b>
ED 0		BIN	2#0000_1111_0000_0000_0000_0000_0000_0000	0 - 31
ED 4		BIN	2#0000_0000_0000_0000_0000_0000_0000_0000	32 - 63
ED 8		BIN	2#0000_0000_0000_0000_0000_0000_0000_0000	64 - 95
ED 12		BIN	2#0000_0000_0000_0000_0000_0000_0000_0000	96 - 127
ED 16		BIN	2#1111_1111_1111_1111_0000_0000_0000_0000	128 - 159
ED 20		BIN	2#0000_0000_0000_0000_0000_0000_0000_0000	160 - 191
ED 24		BIN	2#0000_0000_0000_0000_0000_0000_0000_0000	192 - 223
ED 28		BIN	2#0000_0000_0000_0000_0000_0000_0000_0000	224 - 255
<i>//output address range</i>				
ED 32		BIN	2#0000_1111_0000_0000_0000_0000_0000_0000	0 - 31
ED 36		BIN	2#0000_0000_0000_0000_0000_0000_0000_0000	32 - 63
ED 40		BIN	2#0000_0000_0000_0000_0000_0000_0000_0000	64 - 95
ED 44		BIN	2#0000_0000_0000_0000_0000_0000_0000_0000	96 - 127
ED 48		BIN	2#0000_0000_0000_0000_0000_0000_0000_0000	128 - 159
ED 52		BIN	2#0000_0000_0000_0000_0000_0000_0000_0000	160 - 191
ED 56		BIN	2#0000_0000_0000_0000_0000_0000_0000_0000	192 - 223
ED 60		BIN	2#0000_0000_0000_0000_0000_0000_0000_0000	224 - 255
<i>//slave 6 306-1LE00</i>				
<i>//input address range</i>				
ED 64		BIN	2#0000_0000_0000_0000_0000_0000_0000_0000	0 - 31
ED 68		BIN	2#0000_1111_0000_0000_0000_0000_0000_0000	32 - 63
ED 72		BIN	2#0000_0000_0000_0000_0000_0000_0000_0000	64 - 95
ED 76		BIN	2#0000_0000_0000_0000_0000_0000_0000_0000	96 - 127
ED 80		BIN	2#1111_1111_1111_1111_0000_0000_0000_0000	128 - 159
ED 84		BIN	2#0000_0000_0000_0000_0000_0000_0000_0000	160 - 191
ED 88		BIN	2#0000_0000_0000_0000_0000_0000_0000_0000	192 - 223
ED 92		BIN	2#0000_0000_0000_0000_0000_0000_0000_0000	224 - 255
<i>//output address range</i>				
ED 96		BIN	2#0000_0000_0000_0000_1111_1111_1111_1111	0 - 31
ED 100		BIN	2#0000_1111_0000_0000_0000_0000_0000_0000	32 - 63
ED 104		BIN	2#0000_0000_0000_0000_0000_0000_0000_0000	64 - 95
ED 108		BIN	2#0000_0000_0000_0000_0000_0000_0000_0000	96 - 127
ED 112		BIN	2#0000_0000_0000_0000_0000_0000_0000_0000	128 - 159
ED 116		BIN	2#0000_0000_0000_0000_0000_0000_0000_0000	160 - 191
ED 120		BIN	2#0000_0000_0000_0000_0000_0000_0000_0000	192 - 223
ED 124		BIN	2#0000_0000_0000_0000_0000_0000_0000_0000	224 - 255

Containing address bytes

- ED 0: DI 4: address 4
- ED 16: AI 4: address 128
- ED 32: DO 4: address 0
- ED 68: DI 4: address 32
- ED 80: AI 8: address 128
- ED 96: 4xDO 4: address 16, 20, 24, 28
- ED 100: DO 4: address 32

## Hardware configuration - S5 modules

### Hardware configuration of the modules

After placing the IM 306 slaves place the S5 modules in the plugged sequence.



#### Note!

Please consider that the hardware configuration contains no gaps. Gaps must be ignored!

address	Module	Order number	Firmware	Diagnostic address	Comment
	VIPA 306-1LE00 (DP)	VIPA 306-1LE00		8189	
	VIPA 306-1UE00 (DP)	VIPA 306-1UE00		8188	

In the picture the following modules are color coded:

- Not useable modules
- Modules for diagnostic issues
- User defined modules, for configuration of modules, which do not exist in the GSD file.
- Standard Siemens SIMATIC module types



#### Note!

Please consider that you can only configure digital and analog modules. All other modules are not supported and can lead to a malfunction of your system!

**X-Byte DI/DO**

If you can not find your module in the hardware catalog, you have the possibility to reproduce the module by means of the X-Byte DI/DO Modules according to its address assignment.

Please consider that you may only use 1 slot for each module!  
 A combination of these areas for one module is not possible.



**Caution!**

**Never use the "Universal Module" from the Siemens hardware configurator. This can lead to a configuration error!**

**Configuration**

The screenshot shows the SIMATIC Manager interface. On the left, a hardware rack is configured with a CPU 318-2, DP, MPI/DP, and CP 343-1. A PROFIBUS(6) DP-Mastersystem (1) is connected to two VIPA 30 modules. A 'Properties - DP slave' dialog box is open, showing the 'Parameters' tab. The 'module type' parameter is set to 'SS-135U/155U'. Below the dialog, a table lists the DP ID, Order Number / Designation, I Address, and Q Address for various modules.

DP ID	Order Number / Designation	I Address	Q Address
32	8 Byte DA	4...11	
32	8 Byte DA	12...19	
35	DEA-BG07 32DE/DA	4...7	20...23
3	6ES5 465-4UA11/12 8AE	316...331	
3	6ES5 460-7LA12 8AE	300...315	
3	6ES5 465-7LA11/12/13 16AE	332...363	
3	6ES5 420-7LA11 32DE	8...11	
32	6ES5 441-7LA11/12/13 32DO		24...27

Parameter

For parameterization double-click at the slot overview on the module you want to parameterize. In the appearing dialog window you may set the wanted parameters.

Parameterize in the properties dialog at *Device-specific parameters* the module type "S5-135U/155U" and enter the periphery address.

Conversion  
S5 > S7 format

With the IM 306 DP slave (as from FW 117) and GSD file (as from GSD V2.23) at the analog modules a data conversion S5 > S7 is possible.

Here in the properties of an analog module in the *Device-specific parameters* the parameter *S7 format* may be activated.

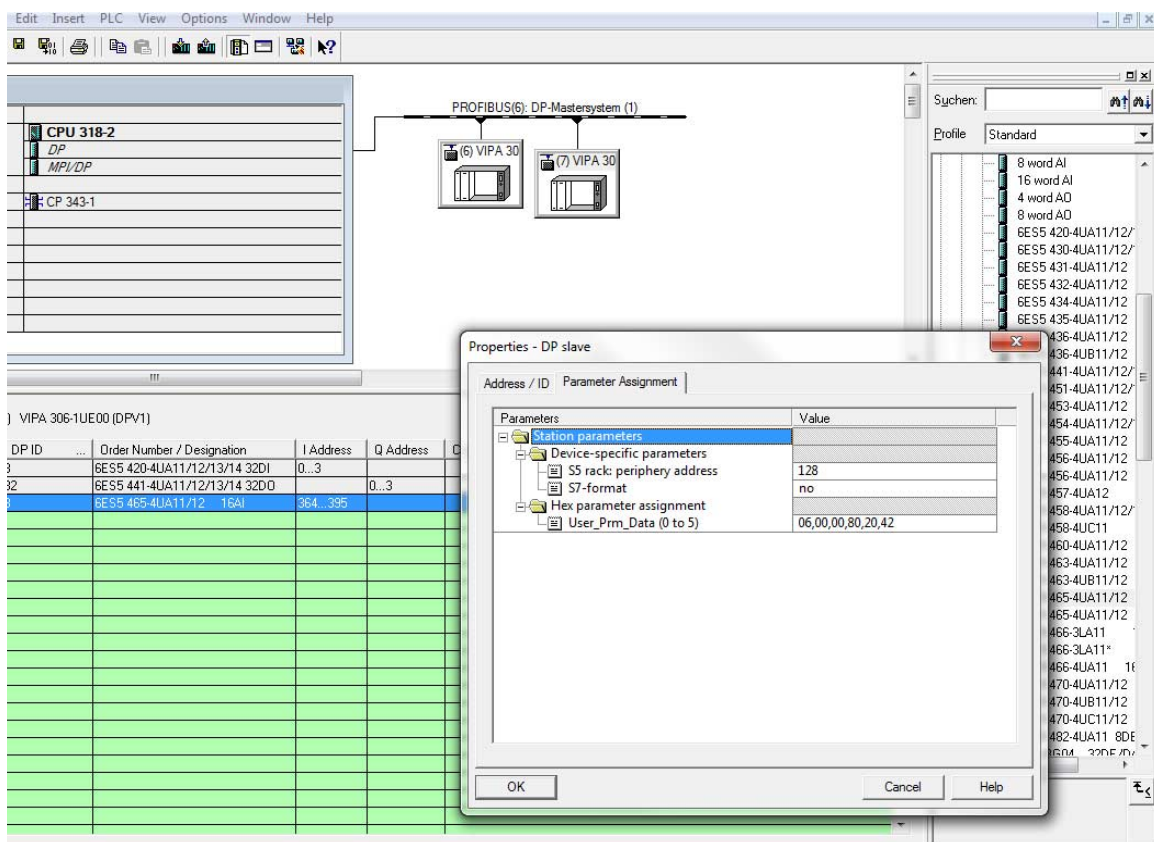

**Data conversion analog input module:**

$$S7: \quad D = U \cdot \frac{27648}{10}, \quad U = D \cdot \frac{10}{27648}$$

$$S5: \quad D = U \cdot \frac{16384}{10}, \quad U = D \cdot \frac{10}{16384}$$

$$\text{Data conversion } S5 > S7: \quad DS7 = DS5 \cdot \frac{27648}{16384} = DS5 \cdot \frac{27}{16}$$

DS7: Decimal value S7 format

DS5: Decimal value S5 format

*U*: Voltage value

*D*: Decimal value

**Data conversion analog output module:**

$$S7: \quad D = U \cdot \frac{27648}{10}, \quad U = D \cdot \frac{10}{27648}$$

$$S5: \quad D = U \cdot \frac{16384}{10}, \quad U = D \cdot \frac{10}{16384}$$

$$\text{Data conversion } S7 > S5: \quad DS5 = DS7 \cdot \frac{16384}{27648} = DS7 \cdot \frac{16}{27}$$

DS7: Decimal value S7 format

DS5: Decimal value S5 format

*U*: Voltage value

*D*: Decimal value

Special  
4 ... 20mA

*Measurement value: 4 ... 20mA*

S5 format: 4mA = 512 ... 20mA = 2560

S7 format: 4mA = 6912 ... 20mA = 34546 (displayed as DWORD)

Should with the measuring range 4 ... 20mA in S5 format 0 ... 2048 or in S7 format 0 ... 27648 are displayed, so a software-based scaling (e.g. scale) must be carried out.

**Backward  
Compatibility****Note!**

If the IM 306 DP slave (< FW 117) with current GSD file (as from GSD V2.23) is used with activated S7 format, this can lead to a configuration error!

## DP-V1 - Services

### Overview

For the deployment of the DP-V1 services you have to take care that your CPU supports DP-V1 communication. More detailed information about this is to be found in the description of your CPU. The following system function blocks are available for this:

SFB 52	Read record set from a DP slave
SFB 53	Write record set to a DP slave
SFB 54	Receive interrupt from a DP slave

Per default, one class-1 master connection and max 3 class-2 master connections with 244byte data (4byte DP-V1 header plus 240byte user data) are supported.

The class-1 master connection is established together with the cyclic connection and is activated via the parameterization.

The class-2 master connection can be used by a class-2 master that then communicates with the slave only acyclical and provides an own connection establishment.

### Data from DP-V1 slave

To access the DP-V1 slave with the Siemens SIMATIC Manager the *diagnostic address*, which can be set by properties, is used as *ID*.

Using the following record set no. as *Index* you get access for reading (R) to the listed DP slave elements:

Index	Access	Description
A0h	R	Device name as ASCII code (VIPA 306-1...)
A1h	R	Hardware Version as ASCII code (V1.00)
A2h	R	Software Version as ASCII code (V1.00)
A3h	R	Serial number of the device as ASCII code (e.g. 000347 = 30h, 30h, 30h, 33h, 34h, 37h)
80h	R	Rack periphery assignment outputs
81h	R	Rack periphery assignment inputs
F1h	R	Process image output module
F2h	R	Process image input module S5 format
F3h	R	Process image input module S5 format + S7 format

### Read process image input periphery

To access the process image of an input module in the rack, for the SFB 52 as *ID* the *start address* is to be used. The *start address* may be preset during hardware configuration of the corresponding module with its properties at "Address/ID".

With the record set number F2h or F3h as *Index* you have reading access to the process image of the appropriate input module.

The access to the output modules is acknowledged by an error message.



## Diagnostic functions

### Overview

PROFIBUS DP provides an extensive set of diagnostic functions for quick error localization. Diagnostic messages are transferred via the bus and collected by the master.

In the case of a diagnostic with DP-V1 the DP slave gets a feedback from the DP master. With DP-V1 the device related diagnostic has been improved as further function and is subdivided into the categories *interrupts* and *status messages*.

### Structure of the diagnostic data

The diagnostic messages, which were created by the PROFIBUS slave, have depending on the parameterization, a maximum length of 127byte.

The structure of the diagnostics data may be influenced by the properties dialog of the IM 306 DP slave. Here the *Identifier/Channel related diagnostic* and the *Module status* may be activated respect. deactivated.

Byte 0 ... 5	Standard diagnostic data	may be enabled or disabled via parameterization
Byte x ... x+3	Identifier related diagnostic	
Byte x ... x+8	Module status	
Byte max. 40·(x ... x+2)	Channel related diagnostic	
Byte x ... x+11	Interrupt	

### Standard diagnostic data

More detailed information about the structure of the slave *Standard diagnostic data* may be found in the standard papers of the PROFIBUS User Organization.

#### Standard diagnostic

Byte	Bit 7 ... Bit 0
0	Bit 0: 0 (fix) Bit 1: Slave is not yet ready for exchange data Bit 2: Configuration data does not correspond to current configuration Bit 3: External slave diagnostic available Bit 4: Requested function is not supported by slave Bit 5: 0 (fix) Bit 6: Wrong parameterization Bit 7: 0 (fix)
1	Bit 0: New parameters have to be assigned to slave Bit 1: Static diagnostic Bit 2: 1 (fix) Bit 3: Response monitoring has been enabled Bit 4: "FREEZE" control command received Bit 5: "SYNC" control command received Bit 6: reserved Bit 7: 0 (fix)
2	Bit 6 ... 0: reserved Bit 7: Diagnostic data overflow
3	Master address after parameterization FFh: Slave has not been parameterized
4	Ident number high byte
5	Ident number low byte

**Identifier related diagnostic**

Via the *Identifier related diagnostic* you gain information at which slot (module) an error has occurred.

More detailed information about the error is available via the *Module state* and the *Channel related diagnostic*.

The *Identifier related diagnostic* may be activated via the parameterization and has the following structure:

*Identifier related diagnostic*

Byte	Bit 7 ... Bit 0
X	Bit 5 ... 0: 000101 (fix) Length of the <i>Identifier related diagnostic</i> Bit 7 ... 6: 01 (fix) Code for <i>Identifier related diagnostic</i>
X+1	The bit is set if one of the following occurs: - a module is removed - a module is connected, which is not configured - a connected module may not be accessed - a module reports a diagnostic interrupt Bit 0: Entry for module at slot 1 Bit 1: Entry for module at slot 2 Bit 2: Entry for module at slot 3 Bit 3: Entry for module at slot 4 Bit 4: Entry for module at slot 5 Bit 5: Entry for module at slot 6 Bit 6: Entry for module at slot 7 Bit 7: Entry for module at slot 8
X+2	Bit 0: Entry for module at slot 9 Bit 1: Entry for module at slot 10 Bit 2: Entry for module at slot 11 Bit 3: Entry for module at slot 12 Bit 4: Entry for module at slot 13 Bit 5: Entry for module at slot 14 Bit 6: Entry for module at slot 15 Bit 7: Entry for module at slot 16
X+3	Bit 0: Entry for module at slot 17 Bit 1: Entry for module at slot 18 Bit 2: Entry for module at slot 19 Bit 3: Entry for module at slot 20 Bit 7 ... 4: reserved



**Module status**

The *Module status* gives you detailed information about the error that occurred at a module.

The *Module status* may be activated via the parameterization and has the following structure:

*Module status*

Byte	Bit 7 ... Bit 0
X	Bit 5 ... 0: 001100 (fix) Length of the Module status Bit 7 ... 6: 00 (fix) Code for Module status
X+1	82h (fix) Status type: Module status
X+2	00h (fix)
X+3	00h (fix)
X+4	For slot 1 ... 20 the following error are specified: 00: Module has valid data 01: Module error - invalid data (Module defective) 10: Incorrect module - invalid data 11: No Module - invalid data Bit 1, 0: Module status module at slot 1 Bit 3, 2: Module status module at slot 2 Bit 5, 4: Module status module at slot 3 Bit 7, 6: Module status module at slot 4
X+5	Bit 1, 0: Module status module at slot 5 Bit 3, 2: Module status module at slot 6 Bit 5, 4: Module status module at slot 7 Bit 7, 6: Module status module at slot 8
X+6	Bit 1, 0: Module status module at slot 9 Bit 3, 2: Module status module at slot 10 Bit 5, 4: Module status module at slot 11 Bit 7, 6: Module status module at slot 12
X+7	Bit 1, 0: Module status module at slot 13 Bit 3, 2: Module status module at slot 14 Bit 5, 4: Module status module at slot 15 Bit 7, 6: Module status module at slot 16
X+8	Bit 1, 0: Module status module at slot 17 Bit 3, 2: Module status module at slot 18 Bit 5, 4: Module status module at slot 19 Bit 7, 6: Module status module at slot 20

**Channel-related Diagnostic**

With the *Channel related diagnostic* you gain detailed information about the channel error within a module. For the usage of the *Channel related diagnostic* you have to release the diagnostic interrupt for every module via the parameterization. The *Channel related diagnostic* may be activated via the parameterization and has the following structure:

*Channel related diagnostic for one channel*

Byte	Bit 7 ... Bit 0
X	Bit 5 ... 0: ID number of the module that delivers the <i>Channel specific diagnostic</i> (000001 ... 010011) e.g.: Slot 1 has ID no. 0 Slot 20 has ID no. 19 Bit 7, 6: 10 (fix) Code for channel-related diagnostic
X+1	Bit 5 ... 0: Number of the channel or the channel group that delivers the diagnostic (00000 ... 11111) Bit 7 ... 6: 01=Input Module 10=Output Module 11=In-/Output Module
X+2	Bit 4 ... 0: <i>Error messages to PROFIBUS standard</i> 00001: Short circuit 00010: Undervoltage (Supply voltage) 00011: Overvoltage (Supply voltage) 00100: Output Module is overloaded 00101: Temperature rise output Module 00110: Open circuit sensors or actors 00111: Upper limit violation 01000: Lower limit violation 01001: Error - Load voltage at the output - Sensor supply - Hardware error in the Module <i>Error messages - manufacturer-specific</i> 10000: Rack periphery address not occupied 10001: Address overlapping in <i>Prm-Data</i> 10010: QVZ - acknowledgement delay Bit 7 ... 5: Channel type 001: bit 010: 2bit 011: 4bit 100: byte 101: word 110: 2words

The maximum number of *Channel related diagnostic* is limited by the total length of 127byte for diagnostic. By de-activating of other diagnostic ranges you may release these areas for further *Channel related diagnostics*. For each channel always 3byte are used.

**Interrupts**

The interrupt section of the slave diagnostic shows information about interrupt type and cause. It consists of max. 12bytes. For every slave diagnostic max. 1 interrupt may be sent. The interrupt section is always the last part of the diagnostic telegram if activated in the parameterization.

## Interrupt status

If there is a diagnostic event for a channel of a module, there may be a module error as well as a channel error.

*Interrupt status*

Byte	Bit 7 ... Bit 0
x	Bit 5 ... 0: 010100: Length of the interrupt section incl. byte x Bit 7 ... 6: 00 (fix) Code for module-related diagnostic
x+1	Bit 6 ... 0: Type of interrupt 0000001: Diagnostic interrupt Bit 7: Code for interrupt
x+2	Bit 7 ... 0: Slot of the module that is producing interrupt 1 ... 20
x+3	Bit 1,0: 00: reserved 01: Diagnostic interrupt <sub>incoming</sub> 10: Diagnostic interrupt <sub>outgoing</sub> 11: reserved Bit 2: 0 (fix) Bit 7 ... 3: interrupt sequence number 1 ...32
x+4	Bit 0: QVZ - acknowledgement delay: Module at rack has malfunction respectively is missing Bit 7 ... 1: reserved
x+5	Bit 3 ... 0: Module class 1111: Digital module 0101: Analog module Bit 7 ... 4: reserved
x+6	70h: Module with digital inputs 71h: Module with analog inputs 72h: Module with digital outputs 73h: Module with analog outputs
x+7	Number of channels per module
x+8	High byte rack periphery address
x+9	Low byte rack periphery address
x+10	Diagnostic event for channel 7 ... 0
x+11	Diagnostic event for channel 15 ... 8

## Firmware update

### Overview

The firmware update for the IM 306 DP slave happens via PROFIBUS and is only available with CPUs with DP-V1 capability like SPEED7 CPUs from VIPA or Siemens CPUs.

For this your firmware is online transferred from the hardware configurator to the CPU, which passes the firmware on to the according DP slave via the connected DP master using PROFIBUS.

### Approach

- Make firmware file available
- Load project into the hardware configurator
- Transfer firmware

### Supply firmware file *header.upd*

The most recent firmware for the IM 306 DP slave may be found at [www.vipa.com](http://www.vipa.com) in the service area at "Firmware for system components" as IM306\_135U.zip. Within the ZIP file the package file Px000096\_Vxxx.zip with xxx=version may be found.

Extract and copy the file *header.upd* into your work directory.

### Load project into hardware configurator

- Open the hardware configurator with the configured DP slave.
- Click on the DP slave and choose **PLC > Update Firmware**.  
This menu option is only available if you have a DP-V1 configuration and the function "Update firmware" is supported by the master system.  
→ The dialog window "Update firmware" appears.
- Choose your work directory via the button "Search" where the file *header.upd* is stored. Choose *header.upd*.  
→ You will see information for which modules and from which firmware version on the chosen file is convenient.
- Activate the control field "Activate firmware after loading" because only then the new firmware is copied to the Flash and click then on [Execute].  
→ It is proofed if the chosen file is valid and at positive result the file is transferred to the DP slave.



### Note!

During runtime the firmware update at the DP slave is executed after app. 3s. Please regard that the DP slave executes a reboot, which may cause the DP master to remain in STOP respectively may influence your user application.