

YASKAWA AC Drive Option LCD Keypad Installation Manual

Type: JVOP-KPLCA04Axx, JVOP-KPLCA04Mxx, JVOP-KPLCA04Kxx

To properly use the product, read this manual thoroughly and retain for easy reference, inspection, and maintenance. Ensure the end user receives this manual.

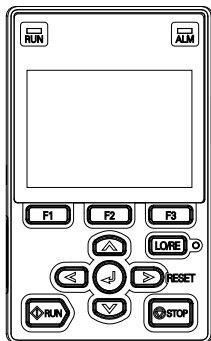

This Page Intentionally Blank

Table of Contents

| | | |
|----|--|----|
| 1. | Preface and Safety | 5 |
| | Applicable Documentation | 5 |
| | Glossary | 5 |
| | Registered Trademarks | 6 |
| | Supplemental Safety Information | 6 |
| 2. | Overview | 7 |
| 3. | Receiving | 7 |
| 4. | Keypad: Names and Functions | 9 |
| | Indicator LEDs and Drive Status | 14 |
| 5. | Installation Procedure | 16 |
| | Section Safety | 16 |
| | Installing the Keypad on the Drive | 16 |
| | Methods to Install a Remote Keypad | 17 |
| | External Dimensions of Keypad | 20 |
| | Procedure A | 21 |
| | Procedure B | 30 |
| | Replace the Keypad Battery | 40 |
| 6. | Keypad Operation | 43 |
| | Check after You Energize the Drive | 43 |
| | Perform the Initial Settings | 44 |

| | |
|---|----|
| Home Screen Display Selection | 46 |
| Use the Keypad to Operate the Drive | 48 |
| Showing the Monitor | 49 |
| Change Parameter Setting Values | 51 |
| Save a Backup of Parameters | 53 |
| Write Backed-up Parameters to the Drive | 56 |
| Verify Keypad Parameters and Drive Parameters | 59 |
| Delete Parameters Backed Up to the Keypad | 62 |
| Check Modified Parameters | 64 |
| Set Backlight to Automatically Turn OFF | 67 |
| Show Information about the Drive | 70 |
| 7. Fault Diagnostics and Measures | 71 |
| 8. Disposal Instructions | 73 |
| WEEE Directive | 73 |
| 9. Specification | 74 |
| 10. Warranty | 75 |
| Warranty Period and Scope | 75 |
| About Application of This Product | 77 |
| Revision History | 78 |

1 Preface and Safety

◆ Applicable Documentation

| Document | Description |
|--|---|
| YASKAWA AC Drive Option LCD Keypad Installation Manual | Read this manual first. The manual contains basic information required to install and wire the keypad. This manual is packaged with the keypad. |
| YASKAWA AC Drive Manuals | Refer to the manuals for the drive to which you are installing this product for information about drive settings. The manuals provide detailed information on basic installation, wiring, operation procedures, functions, troubleshooting, and maintenance. The manuals also include important information about parameter settings and tuning the drive. This manuals can be downloaded from Yaskawa's product and technical information websites printed on the back cover. |

Note:

This manual shows typical examples. Different drive models can have different functions. Refer to the drive manuals for more information.

◆ Glossary

- Drive:
 - YASKAWA AC Drive GA500
 - YASKAWA AC Drive GA700
 - YASKAWA AC Drive GA800
 - YASKAWA AC Drive CR700
 - YASKAWA AC Drive CH700
- Keypad: YASKAWA AC Drive Option LCD Keypad

◆ Registered Trademarks

- Company names and product names mentioned in this manual are trademarks of those companies.

◆ Supplemental Safety Information

Read and understand this manual before you install, operate, or do maintenance on the option. Use this option as specified by this manual and local codes.

The symbol marks in this section identify safety messages in this manual. If you do not obey these safety messages, the hazards can cause serious injury, death, or damage to the products and related equipment and systems.

▲ DANGER *This signal word identifies a hazard that will cause serious injury or death if you do not prevent it.*

▲ WARNING *This signal word identifies a hazard that can cause death or serious injuries if you do not prevent it.*

▲ CAUTION *Identifies a hazardous situation, which, if not avoided, can cause minor or moderate injury.*

NOTICE *This signal word identifies a property damage message that is not related to personal injury.*

■ General Safety

General Precautions

- The figures in this manual can possibly include options and drives without covers or safety shields to show detail. Install missing covers or safety shields before you operate the drive. Use the option only as specified by the instructions in this manual.
- The diagrams in this manual are only examples and are not always related to all the products included in this manual.
- Yaskawa can change the products and specifications in this manual or the content and presentation of the manual without notice to improve the product and/or the manual.
- If you damage or lose manuals, contact a Yaskawa representative or the nearest Yaskawa sales office shown on the rear cover of the manual, and tell them the document number on the front cover to order new copies.

⚠ DANGER

Do not ignore the safety messages in this manual. If you ignore the safety messages in this manual, it will cause serious injury or death. The manufacturer is not responsible for injuries or damage to equipment.

2 Overview

Connect the keypad option to the drive to do these basic operations:

- Read and modify drive parameter settings
- Back up, restore, and verify drive parameters
- Operate and stop the drive
- Monitor drive operation status

◆ Compatible Products

| Product Series | Drive Software Version *1 |
|----------------|------------------------------|
| GA500 | All |
| GA700 | All |
| GA800 | All |
| CR700 | All |
| CH700 | All |

*1 Refer to "PRG" on the drive nameplate for the software version number.

3 Receiving

1. Make sure that the keypad is not damaged and no parts are missing.
Immediately contact the shipping company if the option or other parts are damaged. The Yaskawa warranty does not cover damage from shipping.
2. Make sure that the model number on the option nameplate and the model shown in the purchase order are the same.

Immediately contact the distributor where you purchased the option or the Yaskawa sales office about problems with the option.

◆ Option Package Contents

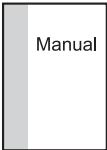
| Option Contents | | Quantity |
|---------------------|---|----------|
| LCD Keypad |  | 1 |
| Installation Manual |  | 1 |

4 Keypad: Names and Functions

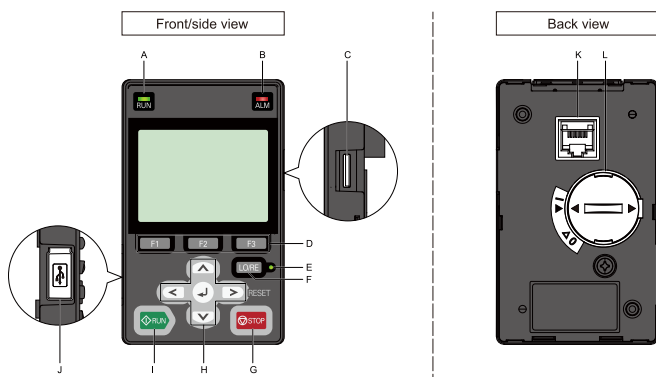



















Figure 4.1 Keypad

Table 4.1 Keypad: Names and Functions

| - | Name | Function |
|---|---|--|
| A | RUN LED  | Illuminates to show that the drive is operating the motor. The LED turns OFF when the drive stops. Flashes to show that: <ul style="list-style-type: none"> The drive is decelerating to stop. The drive received a Run command with a frequency reference of 0 Hz, but the drive is not set for zero speed control. Flashes quickly to show that: <ul style="list-style-type: none"> The drive received a Run command from the MFDI terminals and is switching to REMOTE Mode while the drive is in LOCAL Mode. The drive received a Run command from the MFDI terminals when the drive is not in Drive Mode. The drive received a Fast Stop command. The safety function shut off the drive output. You pushed  on the keypad while the drive is operating in REMOTE Mode. The drive is energized with an active Run command and $b1-17 = 0$ [Run Command at Power Up = Disregard Existing RUN Command]. |
| B | ALM LED  | Illuminates when the drive detects a fault. Flashes when the drive detects: <ul style="list-style-type: none"> An alarm An oPE parameter setting error A fault or alarm during Auto-Tuning The light turns off during regular drive operation. There are no alarms or faults. |
| C | microSD Card Insertion Slot | The insertion point for a microSD card. |



| - | Name | Function |
|---|--|---|
| D | Function Keys F1, F2, F3  | The menu shown on the keypad sets the functions for function keys. The name of each function is in the lower half of the display window. |
| E | LO/RE LED  | Illuminated: The keypad controls the Run command (LOCAL Mode). OFF: The control circuit terminal or serial transmission device controls the Run command (REMOTE Mode). Note: <ul style="list-style-type: none"> • LOCAL: Use the keypad to operate the drive. Use the keypad to enter Run/Stop commands and the frequency reference command. • REMOTE: Use the control circuit terminals or serial transmission to operate the drive. Use the frequency reference source in <i>b1-01</i> and the Run command source in <i>b1-02</i>. |
| F | LO/RE Selection Key  | Switches drive control for the Run command and frequency reference between the keypad (LOCAL) and an external source (REMOTE). Note: <ul style="list-style-type: none"> • The LOCAL/REMOTE Selection Key continuously stays enabled after the drive stops in Drive Mode. If the application must not switch from REMOTE to LOCAL because it will have a negative effect on system performance, set <i>o2-01 = 0</i> [<i>LO/RE Key Function Selection = Disabled</i>] to disable . • If the drive is receiving a Run command from an external source, it will not switch between LOCAL and REMOTE. |
| G | STOP Key  | Stops drive operation. Note: Push  to stop the motor. This will also apply when a Run command (REMOTE Mode) is active at an external Run command source. Set <i>o2-02 = 0</i> [<i>STOP Key Function Selection = Disabled</i>] to disable  in REMOTE Mode. |



4 Keypad: Names and Functions

| - | Name | Function |
|---|---|---|
| H | Left Arrow Key  | <ul style="list-style-type: none"> Moves the cursor to the left. Goes back to the previous screen. |
| | Up Arrow Key/Down Arrow Key  /  | <ul style="list-style-type: none"> Scrolls up or down to show the next item or the previous item. Selects parameter numbers, and increments or decrements setting values. |
| | Right Arrow Key (RESET)  | <ul style="list-style-type: none"> Moves the cursor to the right. Continues to the next screen. Restarts the drive to clear a fault. |
| | ENTER Key  | <ul style="list-style-type: none"> Enters parameter values and settings. Selects menu items to move between keypad displays. Selects each mode, parameter, and setting value. |
| I | RUN Key  | Starts the drive in LOCAL Mode. Starts the operation in Auto-Tuning Mode. Note: Before you use the keypad to operate the motor, push  on the keypad to set the drive to LOCAL Mode. |
| J | USB Terminal | Insertion point for a USB cable. Uses a USB cable (USB standard 2.0, type A - mini-B) to connect the keypad to a PC. |
| K | RJ-45 Connector | Connects to the drive using an RJ-45 8-pin straight through UTP CAT5e extension cable or keypad connector. |
| L | Clock Battery Cover | Remove this cover to install or replace the clock battery. Note: <ul style="list-style-type: none"> You must supply the clock battery. It is not included with the keypad. For information about the correct battery and the installation procedure, refer to "Replacing the Keypad Battery" (page 40). |

⚠ WARNING *Sudden Movement Hazard. If you change the control source when b1-07 = 1 [LOCAL/REMOTE Run Selection = Accept Existing RUN Command], the drive can start suddenly. Before you change the control source, remove all personnel from the area around the drive, motor, and load. Sudden starts can cause serious injury or death.*

◆ Indicator LEDs and Drive Status

| LED | Display | Drive Status |
|--|------------------|---|
| RUN LED  | Illuminated | The drive is operating the motor. |
| | Flashing | <ul style="list-style-type: none"> The drive is decelerating to stop. The drive received a Run command with a frequency reference of 0 Hz, but the drive is not set for zero speed control. The drive received a DC Injection Braking command. |
| | Flashing Quickly | <ul style="list-style-type: none"> The drive received a Run command from the MFDI terminals and is switching to REMOTE Mode while the drive is in LOCAL Mode. The drive received a Run command from an external source and the drive is not in Drive Ready (READY) condition. The drive received a Fast Stop command. The safety function shut off the drive output. You pushed  on the keypad while the drive is operating in REMOTE Mode. The drive is energized with an active Run command and $b1-17 = 0$ [Run Command at Power Up = Disregard Existing RUN Command]. When $b1-03 = 3$ [Stopping Method Selection = Coast to Stop with Timer], the Run command is disabled then enabled during the Run wait time. The drive received a DC Injection Braking command. The voltage of the main circuit power supply decreased, and the 24 V power supply is supplying power only the the drive. |
| | OFF | The motor is stopped. |

| LED | Display | Drive Status |
|--|-------------|--|
| ALM LED  | Illuminated | The drive detects a fault. |
| | Flashing | The drive detected one of the following: <ul style="list-style-type: none"> • An alarm • An oPE parameter setting error • A fault or error during Auto-Tuning Note: The digital characters displayed on the keypad will also flash. |
| | OFF | There are no drive faults or alarms. |
| LO/RE LED  | Illuminated | The keypad controls the Run command (LOCAL Mode). |
| | OFF | The control circuit terminal or serial transmission device controls the Run command (REMOTE Mode). |

■ LED Flashing Statuses

Refer to [Figure 4.2](#) for information about the differences between flashing and “flashing quickly”.

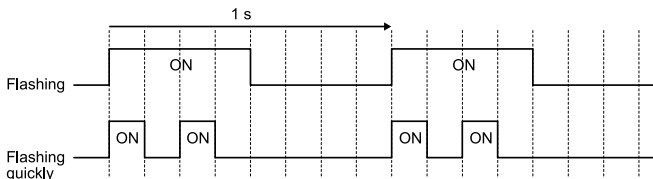

Figure 4.2 LED Flashing Statuses

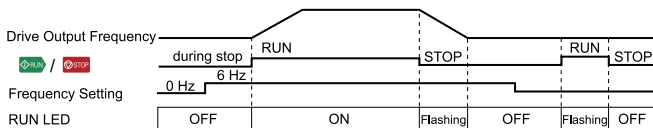

Figure 4.3 Relation between RUN indicator and Drive Operation

5 Installation Procedure

◆ Section Safety

NOTICE *Damage to Equipment.* Correctly connect all pins and connectors. If the pins and connectors are incorrect, it can cause damage to equipment and incorrect operation.

NOTICE *Damage to Equipment.* Do not bend the communication cables more than the bend radius specifications. If you bend the cables too much, it can break the wires and loosen connections.

Note:

Use Yaskawa connection cables or recommended cables only. Incorrect cables can cause the drive or option to function incorrectly.

◆ Installing the Keypad on the Drive

1. Remove the keypad that shipped with the drive.

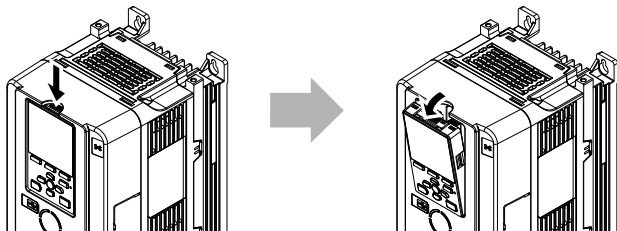

Figure 5.1 Remove the Keypad

- Put the bottom of the keypad into position first, then carefully push on the top of the keypad until the hook clicks into place.

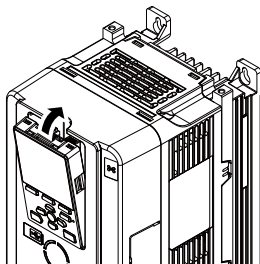

Figure 5.2 Attach the Keypad

◆ Methods to Install a Remote Keypad

| Installation Method | Description | Required Tools |
|----------------------|---|---|
| External/Face-Mount | Installs the option on the outside of the panel. An optional installation bracket is not necessary for this installation. | Phillips screwdriver #2 (M3) |
| Internal/Flush-Mount | Encloses the keypad in the panel. The front of the keypad is flush with the outside of the panel. | <ul style="list-style-type: none"> Phillips screwdriver #2 (M3, M4) Installation support set A (for mounting with screws, model: 900-192-933-001) |
| | | <ul style="list-style-type: none"> Phillips screwdriver #2 (M3) Wrench (M4) Installation support set B (for mounting with nut clamp, model: 900-192-933-002) |

Note:

Installation support sets are sold separately. When there are weld studs on the interior of the control panel, use installation support set B.

■ Installation Procedure

The installation procedure is different for different drives.

| Drive | Procedure | Page |
|-------------------------------|-----------|------|
| GA700, GA800, CR700, CH700 | A | 21 |
| GA500 | B | 30 |

■ Optional Items

The optional extension cable and installation support set are necessary for Internal/Flush-Mount installation.

Contact Yaskawa or your nearest sales representative to order optional items.

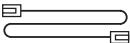
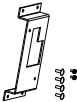
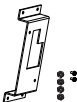
| Item | Part Number | Notes |
|--|-----------------|--|
| Extension cable (1 m (3.3 ft.))  | WV001 *1 | Connects the keypad for remote operation. <ul style="list-style-type: none"> • RJ-45 8-pin straight through • UTP CAT5e cable (1 m (3.3 ft.)/3 m (9.8 ft.)) |
| Extension cable (3 m (9.8 ft.))  | WV003 *1 | <div style="background-color: #0070C0; color: white; padding: 2px;">NOTICE</div> <i>Damage to Equipment. Do not use this cable to connect the drive to a PC. Failure to obey will cause damage to the PC.</i> |
| Installation support set A (screw clamp)  | 900-192-933-001 | Encloses the keypad in the panel. <ul style="list-style-type: none"> • M3 screws: 6 mm (0.24 in.) depth Phillips recessed pan head machine screws (2) • M4 screws: 10 mm (0.39 in.) depth Phillips truss head screws (4) (for panel thickness of 1 to 1.6 mm (0.04 to 0.06 in.)) |
| Installation support set B (nut clamp)  | 900-192-933-002 | Encloses the keypad in the panel. When there are weld studs on the interior of the control panel, use the installation support set B (nut clamp). <ul style="list-style-type: none"> • M3 screws: 6 mm (0.24 in.) depth Phillips recessed pan head machine screws (2) |

*1 Part numbers for the U.S.A. are UWR0051 and UWR0052. Contact Yaskawa or your nearest sales representative for more information.

External Dimensions of Keypad

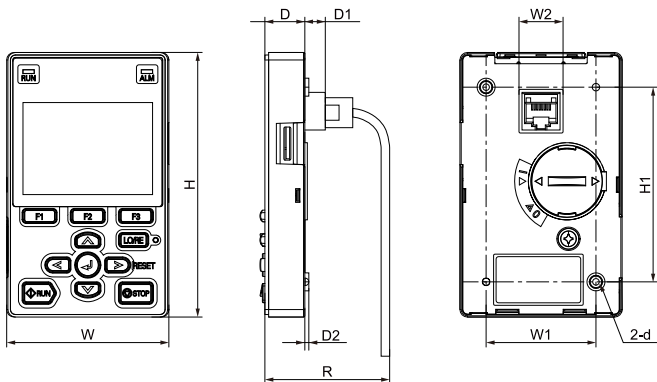

Figure 5.3 Exterior and Mounting Dimensions

Table 5.1 Dimensions mm (in)

| W | H | D | D1 | D2 | R *1 | W1 | W2 | H1 | d |
|--------------|---------------|--------------|---------------|---------------|------------------|--------------|--------------|--------------|----|
| 65 (2.56) | 106 (4.17) | 16 (0.63) | 8.2 (0.32) | 1.6 (0.06) | ≥ 53.8 (2.12) | 44 (1.73) | 15 (0.59) | 78 (3.07) | M3 |

*1 Minimum bending radius

NOTICE *Damage to Equipment. Do not bend the communication cables more than the bend radius specifications. If you bend the cables too much, it can break the wires and loosen connections.*

■ Procedure A

External/Face-Mount Installation

1. Use the dimensions in [Table 5.2](#) and [Figure 5.4](#) to cut an opening and tap two holes in the enclosure panel.

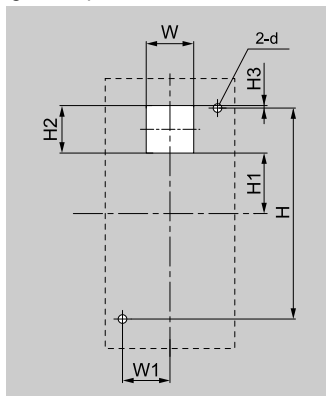
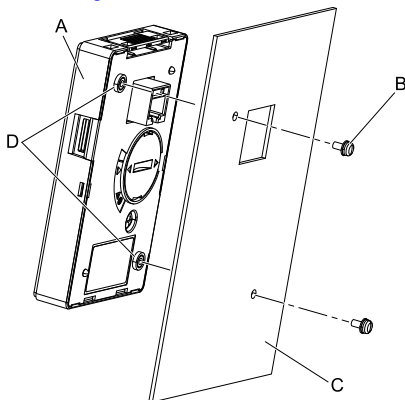

Figure 5.4 External/Face Mount Enclosure Panel Cut-Out Dimensions

Table 5.2 Enclosure Panel Cut-Out Dimensions mm (in.)

| W | H | W1 | H1 | H2 | H3 | d |
|--------------|--------------|--------------|--------------|--------------|-------------|---------------|
| 22 (0.87) | 78 (3.07) | 22 (0.87) | 29 (1.14) | 22 (0.87) | 1 (0.04) | 3.6 (0.14) |

2. Use M3 screws (6 mm (0.24 in) depth cross-recessed pan head screws) to attach the keypad from the inside as shown in [Figure 5.5](#).



A - Keypad

B - M3 screws

C - Enclosure panel

D - Screw mounting hole

Figure 5.5 External/Face-Mount Installation

3. Push the tab on the top of the drive keypad and carefully pull forward to remove the keypad from the drive.

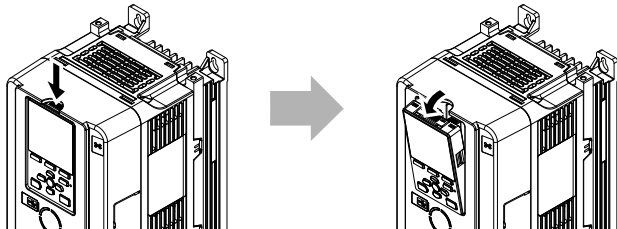

Figure 5.6 Removing the Included Drive Keypad

4. Remove the keypad connector and put the keypad connector in the holder on the front cover.

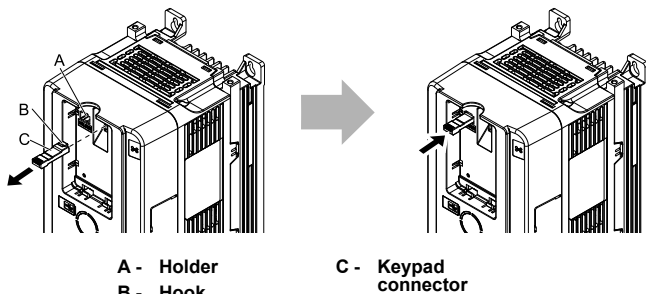
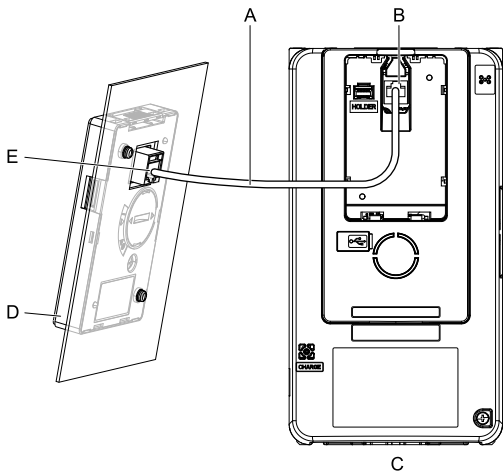

Figure 5.7 Moving the Keypad Connector to the Holder

- Use the extension cable to connect the drive to the keypad.



- | | |
|------------------------------|---------------------|
| A - Extension cable | D - Keypad |
| B - Communications connector | E - Cable connector |
| C - Drive | |

Figure 5.8 Connecting the Drive and Keypad with the Extension Cable

Internal/Flush-Mount Installation

Installation support sets A or B (sold separately) are necessary for Internal/Flush-Mount installation. The installation procedure is the same for installation support sets A and B. Contact Yaskawa or your nearest sales representative to order optional items.

- Use the dimensions in [Table 5.3](#) and [Figure 5.9](#) to cut an opening and tap two holes in the enclosure panel. The panel cut-out dimensions are the same for installation support sets A and B.

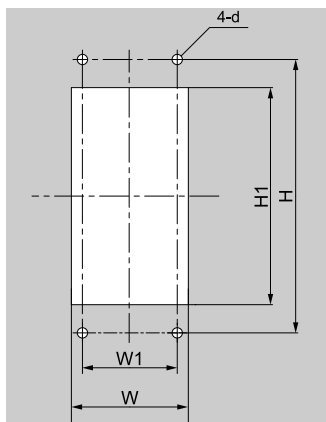
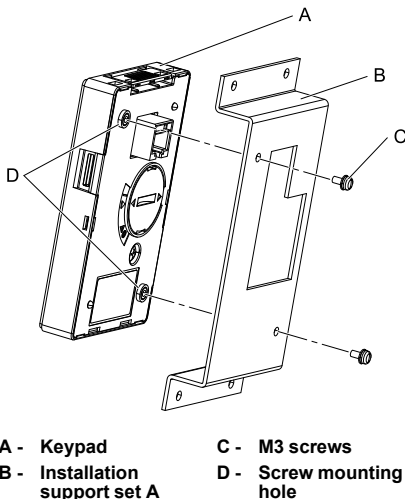

Figure 5.9 Internal/Flush-Mount Enclosure Panel Cut-Out Dimensions

Table 5.3 Enclosure Panel Cut-Out Dimensions mm (in.)

| W | H | W1 | H1 | d |
|---------------------------|---------------|--------------|----------------------------|---------------|
| 64 + 0.5 (2.52 + 0.02) | 130 (5.12) | 45 (1.77) | 105 + 0.5 (4.13 + 0.02) | 4.8 (0.19) |

2. Use the screws included in the support set as shown in [Figure 5.10](#) to attach the keypad to the installation support.



- A - Keypad** **C - M3 screws**
B - Installation support set A **D - Screw mounting hole**

Figure 5.10 Mounting the Keypad to Installation Support Set A

3. Use the M4 screws included in the support set as shown in [Figure 5.11](#) to attach the installation support and keypad to the enclosure panel.

Note:

Use a gasket between the control panel and the keypad in areas where dust or other airborne unwanted materials could cause damage to the drive.

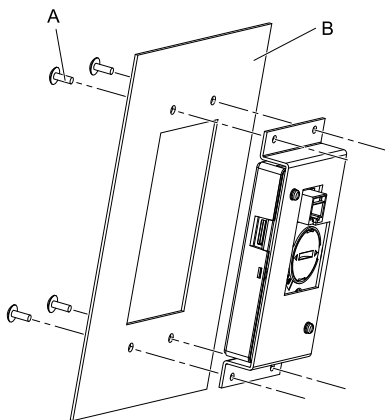

A - M4 screws

B - Enclosure panel

Figure 5.11 Internal/Flush-Mount Installation

4. Push the tab on the top of the drive keypad and carefully pull forward to remove the keypad from the drive.

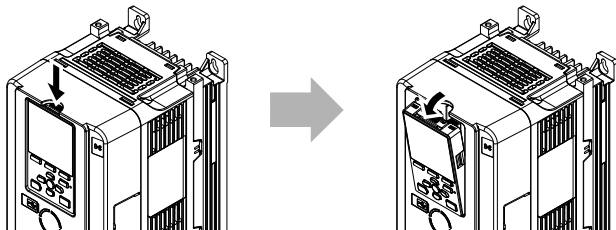

Figure 5.12 Removing the Included Drive Keypad

5. Remove the keypad connector and put the keypad connector in the holder on the front cover.

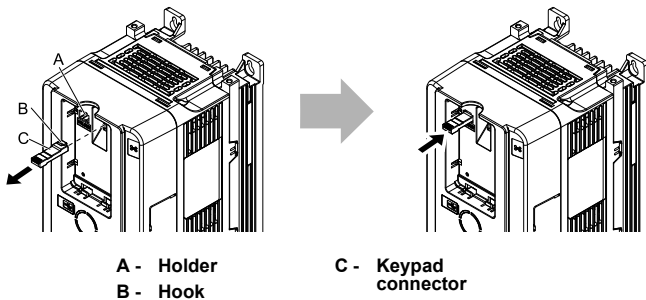
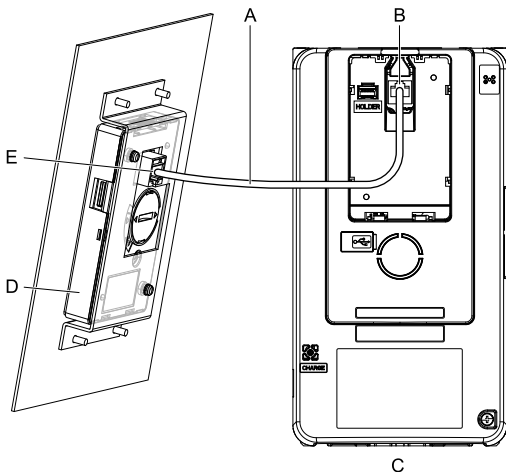

Figure 5.13 Moving the Keypad Connector to the Holder

6. Use the extension cable to connect the drive to the keypad.



- A - Extension cable D - Keypad
B - Communications connector
E - Cable connector
C - Drive

Figure 5.14 Connecting the Drive and Keypad with the Extension Cable

■ Procedure B

External/Face-Mount Installation

1. Use the dimensions in [Table 5.4](#) and [Figure 5.15](#) to cut an opening and tap two holes in the enclosure panel.

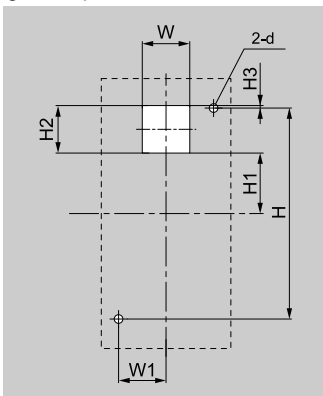
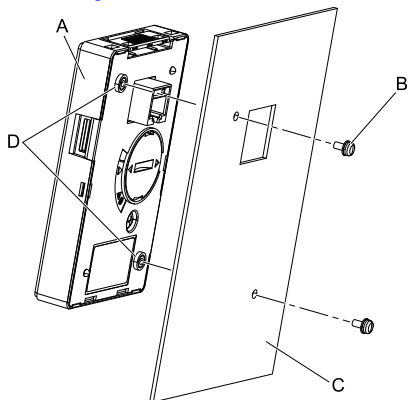

Figure 5.15 External/Face Mount Enclosure Panel Cut-Out Dimensions

Table 5.4 Enclosure Panel Cut-Out Dimensions mm (in.)

| W | H | W1 | H1 | H2 | H3 | d |
|--------------|--------------|--------------|--------------|--------------|-------------|---------------|
| 22 (0.87) | 78 (3.07) | 22 (0.87) | 29 (1.14) | 22 (0.87) | 1 (0.04) | 3.6 (0.14) |

2. Use M3 screws (6 mm (0.24 in) depth cross-recessed pan head screws) to attach the keypad from the inside as shown in [Figure 5.16](#).



A - Keypad
B - M3 screws

C - Enclosure panel
D - Screw mounting holes

Figure 5.16 External/Face-Mount Installation

3. Use a slotted screwdriver to unlock the front cover of the drive.

Use a slotted screwdriver with a tip width of 2.5 mm (0.1 in) or less and a thickness of 0.4 mm (0.02 in) or less.

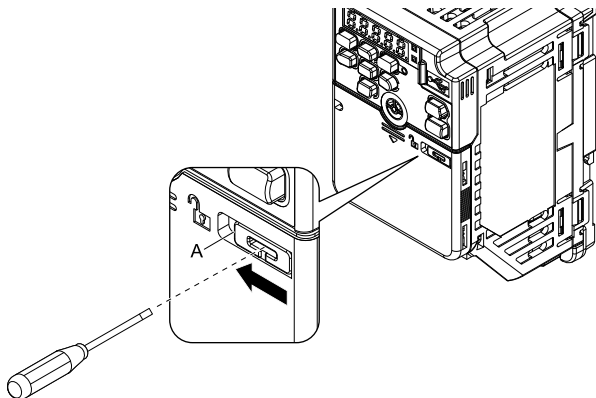

A - Front cover lock

Figure 5.17 Unlocking

4. Slide the front cover down and remove it from the drive.

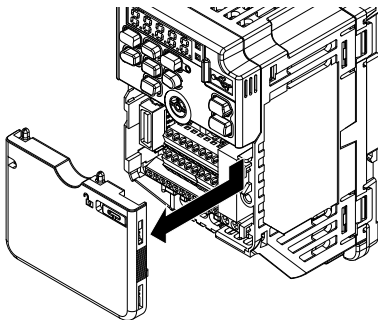

Figure 5.18 Remove the Front Cover

5. Push on the tab on the right side of the keypad, then pull the keypad forward to remove it from the drive.

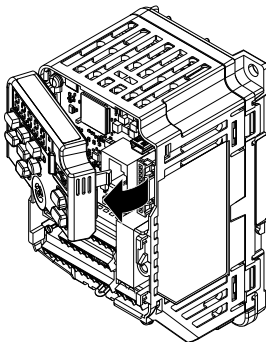
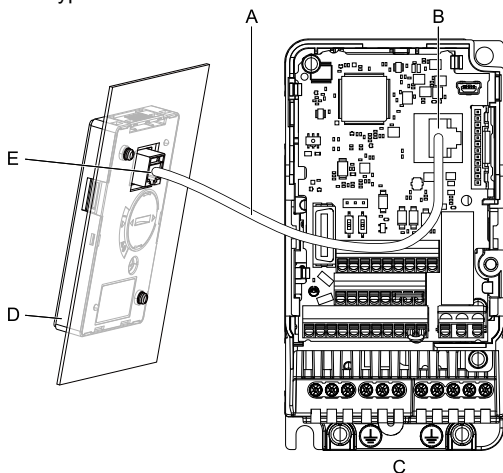

Figure 5.19 Removing the Included Drive Keypad

- Use the extension cable to connect the drive to the keypad.



- A - Extension cable D - Keypad
 B - Communications connector E - Cable connector
 C - Drive

Figure 5.20 Connecting the Drive and Keypad with the Extension Cable

Internal/Flush-Mount Installation

Installation support sets A or B (sold separately) are necessary for Internal/Flush-Mount installation. The installation procedure is the same for installation support sets A and B. Contact Yaskawa or your nearest sales representative to order optional items.

- Use the dimensions in [Table 5.5](#) and [Figure 5.21](#) to cut an opening in the control panel for the keypad.
 The panel cut-out dimensions are the same for installation support sets A and B.

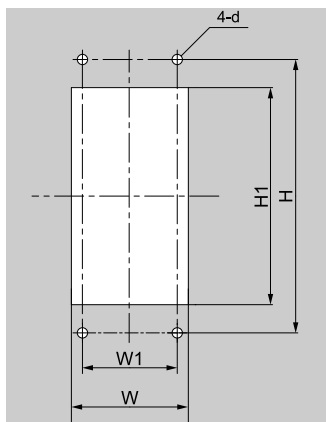
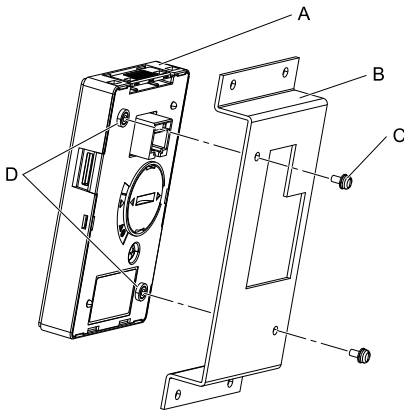

Figure 5.21 Internal/Flush-Mount Enclosure Panel Cut-Out Dimensions

Table 5.5 Enclosure Panel Cut-Out Dimensions mm (in.)

| W | H | W1 | H1 | d |
|---------------------------|---------------|--------------|----------------------------|---------------|
| 64 + 0.5 (2.52 + 0.02) | 130 (5.12) | 45 (1.77) | 105 + 0.5 (4.13 + 0.02) | 4.8 (0.19) |

2. Use the screws included in the support set as shown in [Figure 5.22](#) to attach the keypad to the installation support.



- | | |
|--------------------------------|-------------------------|
| A - Keypad | C - M3 screws |
| B - Installation support set A | D - Screw mounting hole |

Figure 5.22 Mounting the Keypad to Installation Support Set A

3. Use the M4 screws included in the support set as shown in [Figure 5.23](#) to attach the installation support and keypad to the enclosure panel.

Note:

Use a gasket between the control panel and the keypad in areas where dust or other airborne unwanted materials could cause damage to the drive.

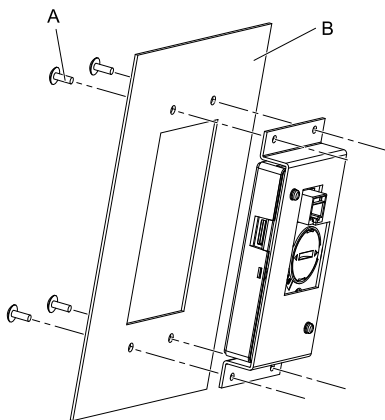

A - M4 screws

B - Enclosure panel

Figure 5.23 Internal/Flush-Mount Installation

4. Use a slotted screwdriver to unlock the front cover of the drive.

Use a slotted screwdriver with a tip width of 2.5 mm (0.1 in) or less and a thickness of 0.4 mm (0.02 in) or less.

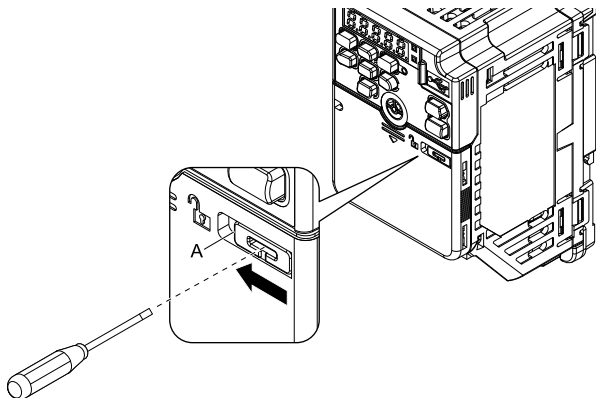

A - Front cover lock

Figure 5.24 Unlocking

5. Slide the front cover down and remove it from the drive.

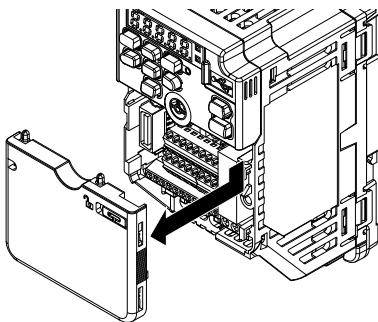

Figure 5.25 Remove the Front Cover

6. Push on the tab on the right side of the keypad, then pull the keypad forward to remove it from the drive.

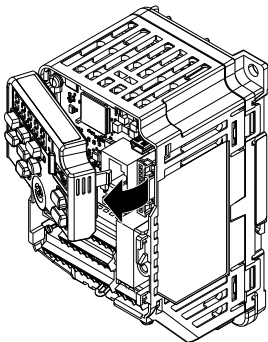
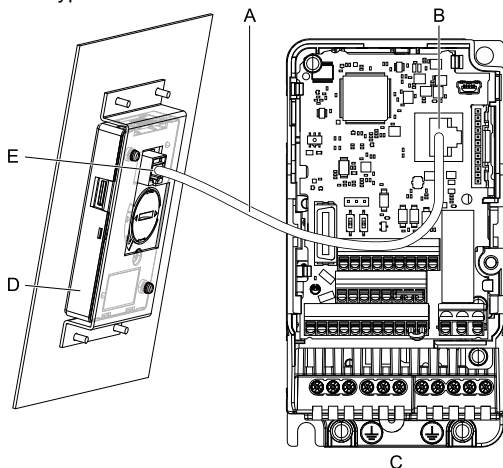

Figure 5.26 Removing the Included Drive Keypad

7. Use the extension cable to connect the drive to the keypad.



- A - Extension cable D - Keypad
B - Communications connector E - Cable connector
C - Drive

Figure 5.27 Connecting the Drive and Keypad with the Extension Cable

◆ Replace the Keypad Battery

When the keypad battery is expired, the date and time go back to the default settings. Use this procedure to replace the battery.

⚠ WARNING *Fire Hazard. Handle keypad batteries properly. Do not charge the battery or disassemble the keypad. If the battery explodes, it can cause a fire.*

To replace the battery, use a Hitachi Maxell “CR2016 Lithium Manganese Dioxide Lithium Battery” or an equivalent battery with these properties:

- Nominal voltage: 3 V
- Operating temperature range: -20 °C to + 85°C (-4 °F to +185 °F)

⚠ WARNING *Fire Hazard. Do not disassemble batteries. Do not expose batteries to heat or fire. If the battery explodes, it can cause a fire.*

NOTICE *Damage to Equipment. The keypad battery stays in use after you de-energize the drive. When you will keep the drive de-energized for long periods of time, remove the battery from the keypad. When the expected life of the battery is complete, replace the battery immediately. A dead battery in the keypad can leak and cause damage to the keypad and drive.*

The performance life estimate of a new battery is:

- Ambient temperature 20 °C (68 °F): 5 years
- Ambient temperature -10 °C to +50 °C (14 °F to 122 °F): 3.5 years

1. De-energize the drive and remove the keypad.

2. Use a slotted screwdriver or other tool to turn the battery cover counterclockwise and remove the cover.

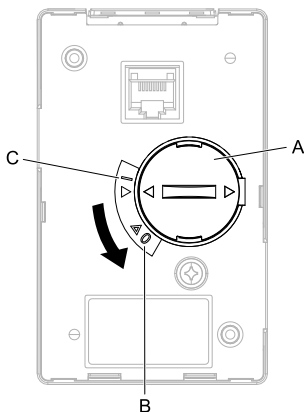

- A - Battery cover** **C - Closed**
B - Opened

Figure 5.28 Remove the Battery Cover

3. Remove the used battery from the keypad.
4. Insert the new battery.

Note:

- The battery cover side is the positive pole. Make sure that the polarity is correct when you put the battery in the keypad.
- Discard the used battery as specified by local regulations.

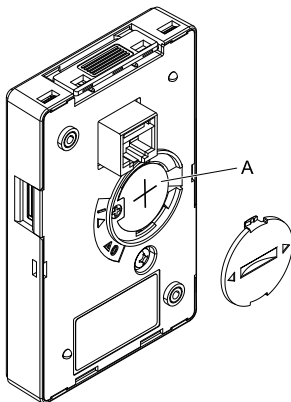

A - Battery

Figure 5.29 Insert the New Battery





5. Put the battery cover on the keypad and use a slotted screwdriver to turn the battery cover clockwise to close it.
6. Install the keypad on the drive.

6 Keypad Operation

◆ Check after You Energize the Drive

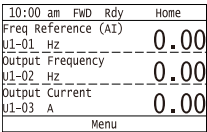
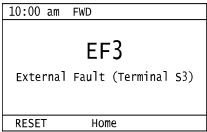
Check the items in [Table 6.1](#) after you energize the drive. The keypad will show these screens depending on the drive status.

Table 6.1 Display Status after Energizing the Drive

| Status | Display | Description |
|--------------------------------|---|--|
| During Usual Operation |  <p>Initial Setup Screen or</p>  <p>HOME Screen</p> | <ul style="list-style-type: none"> The data display area will show the Initial Setup screen or the HOME screen Energize the drive with factory defaults to show the Initial Setup screen. Select [No] from the [Show Initial Setup Screen] settings to show the HOME screen without showing the Initial Setup screen. |
| When the Drive Detects a Fault |  | <p>The display is different for different faults. Refer to “Troubleshooting” to remove the cause of the fault.  will illuminate.</p> <p>Note: If the screen shows a different screen, do these steps to show the fault content again:</p> <ol style="list-style-type: none"> Push  from the HOME screen. Push  (Home) from a different screen than the HOME screen. |

◆ Perform the Initial Settings

The keypad will show the Initial Setup screen when you energize the drive the first time. You can set the date and time or the language shown on the keypad. The Setup Wizard prepares sets

basic parameters and does Auto-Tuning to prepare the drive for operation.

Note:

If the keypad does not show the Initial Setup screen, or shows a different screen, select [Initial Setup] from the Main Menu to show the Initial Setup screen.

1. Make the initial settings for each item.

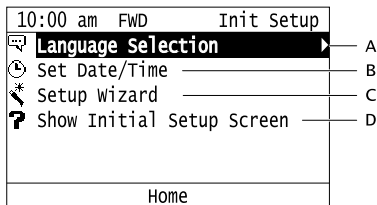

A - Language Selection

C - Setup Wizard

B - Set Date/Time

D - Show Initial Setup Screen

Note:

When you select [Yes] from the [Show Initial Setup Screen] setting, the keypad will show the Initial Setup screen each time you energize the drive. When you select [NO], the keypad will not show the Initial Setup screen when you energize the drive, starting with the next time.

2.  Push (Home).

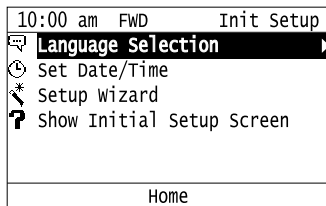

The display shows the HOME screen.

◆ Home Screen Display Selection



This section gives information about the functions that you can control from the HOME screen and the content shown on the HOME screen.

| | | |
|---------------------|---------|---------|
| 10:00 am | FWD Rdy | Home |
| Freq Reference(KPD) | | 0.00 |
| U1-01 | Hz | |
| Output Frequency | | 0.00 |
| U1-02 | Hz | |
| Output Current | | 0.00 |
| U1-03 | A | |
| JOG | Menu | FWD/REV |

■ View Monitors Shown in Home Screen

This figure shows monitor data in the data display area of the HOME screen.

| | | | |
|----------------------|---------|---------|-----------|
| 10:00 am | FWD Rdy | Home | |
| Freq Reference (KPD) | | 0.00 | — Monitor |
| U1-01 | Hz | | |
| Output Frequency | | 0.00 | |
| U1-02 | Hz | | |
| Output Current | | 0.00 | |
| U1-03 | A | | |
| JOG | Menu | FWD/REV | |

- To change what the screen shows, change the setting for *o1-40* [*Home display selection*].
- When *o1-40* [*Home display selection*] is set to “Custom Monitor”, and there is more than one screen, use  or  to switch between screens.

■ JOG Operation

Push **LO/RE** to illuminate . Push and hold **F1** (JOG) to run the motor. Release **F1** to stop the motor.



■ Change Motor between Forward/Reverse Run

You can change the direction of motor rotation when you use the keypad to operate the drive. Push **LO/RE** to illuminate . Push and hold **F3** (FWD/REV) to toggle the direction of motor rotation between forward and reverse.







■ Show the Standard Monitor

Push  to show the standard monitor (*Ux-xx*). Push **F2** (HOME) to go back to the HOME screen.

Note:

When a fault, minor fault, or an error occurs, push  to show the content of the fault. Push  again to show the standard monitor (*Ux-xx*).



■ Change the Frequency Reference Value

1. Push  to access the screen to change the frequency.
2. Push  or  to select the digit, then push  or  to change the value.
3. Push  to keep the changes.

Note:

The HOME screen must show *UI-01 [Frequency Reference]* or you must set the keypad as the Run command source (REMOTE) to use this function.





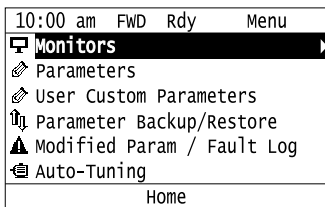



■ Show the Main Menu

Push  to show the main menu. Push  (HOME) to go back to the HOME screen.



◆ Use the Keypad to Operate the Drive

This section gives information about how to use the keypad to operate the drive.

1. Energize the drive, or push  (Home) to show the HOME screen.
If [Home] is not shown on , push  (Back) to show [Home] on .
2. Push  to illuminate the LOCAL/REMOTE LED.
3. Push  to show *d1-01 [Reference 1]*, and set it to 6.00 Hz.
4. Push .
The RUN LED illuminates, and the motor runs at 6.00 Hz in the forward direction.
5. Push  to increase the frequency reference value.
6. Push .
The RUN LED will flash. When the motor stops, the LED will go out.

◆ Showing the Monitor

This section shows how to show the standard monitors (*Ux-xx*).

1. Push **F2** (Home) to show the HOME screen.







Note:



- When the drive is in HOME Mode, the screen shows [Home] in the upper right-hand corner of the screen.
- If the screen does not show [Home] for **F2**, push **F1** (Back), and then push **F2** to show [Home].

2. Push **F2** (Menu).



| | | | |
|---------------------|-----|-----|------|
| 10:00 am | FWD | Rdy | Home |
| Freq Reference (AI) | | | 0.00 |
| U1-01 | Hz | | 0.00 |
| Output Frequency | | | 0.00 |
| U1-02 | Hz | | 0.00 |
| Output Current | | | 0.00 |
| U1-03 | A | | 0.00 |
| Menu | | | |

3. Push  or  to select [Monitors], then push .



| | | | |
|---|----------------------------|-----|---|
| 10:00 am | FWD | Rdy | Menu |
|  | Monitors | |  |
|  | Parameters | | |
|  | User Custom Parameters | | |
|  | Parameter Backup/Restore | | |
|  | Modified Param / Fault Log | | |
|  | Auto-Tuning | | |
| Home | | | |

4. Push  or  to select [Standard Monitor], then push .

| | | | |
|-------------------------|-----|------|---------|
| 10:00 am | FWD | Rdy | Monitor |
| Standard Monitor | | | ▶ |
| Custom Monitor | | | |
| Bar Graph | | | |
| Analog Gauge | | | |
| Trend Plot | | | |
| Back | | Home | |

5. Push  or  to select monitor group, then push .

| | | | |
|-------------------------------------|-----|------|---------|
| 10:00 am | FWD | Rdy | Monitor |
| U1 Operation Status Monitors | | | ▶ |
| U2 Fault Trace | | | |
| U3 Fault History | | | |
| U4 Maintenance Monitors | | | |
| U5 PID Monitors | | | |
| U6 Operation Status Monitors | | | |
| Back | | Home | |

6. Push  or  to change the monitor number to show the monitor item.

Note:

Push  to go back to the previous page.

| | | | |
|----------------------|---------|-----|---------|
| 10:00 am | FWD | Rdy | Monitor |
| Terminal A1 Input Lv | U1-13 % | | 0.0 |
| Terminal A2 Input Lv | U1-14 % | | 0.0 |
| Terminal A3 Input Lv | U1-15 % | | 0.0 |
| Home | | | |

◆ Change Parameter Setting Values

This example shows how to change the setting value for *C1-01* [Acceleration Time 1]. Do the steps in this procedure to set parameters for the application.

1. Push **F2** (Home) to show the HOME screen.







Note:



- When the drive is in HOME Mode, the screen shows [Home] in the upper right-hand corner of the screen.
- If [Home] is not shown above the **F2**, push **F1** (Back).

2. Push **F2** (Menu).



| | | |
|---------------------|---------|------|
| 10:00 am | FWD Rdy | Home |
| Freq Reference (AI) | | |
| U1-01 | Hz | 0.00 |
| ----- | | |
| Output Frequency | | |
| U1-02 | Hz | 0.00 |
| ----- | | |
| Output Current | | |
| U1-03 | A | 0.00 |
| ----- | | |
| Menu | | |

3. Push  or  to select [Parameters], then push .



| | | |
|---|----------------------------|---|
| 10:00 am | FWD | Menu |
| Monitors | | |
|  | Parameters |  |
|  | User Custom Parameters | |
|  | Parameter Backup/Restore | |
|  | Modified Param / Fault Log | |
|  | Auto-Tuning | |
| ----- | | |
| Home | | |

4. Push  or  to select [C Tuning], then push .





| | | |
|-----------------------------|------|------------|
| 10:00 am | FWD | Parameters |
| A Initialization Parameters | | |
| b Application | | |
| C Tuning ▶ | | |
| d References | | |
| E Motor Parameters | | |
| F Options | | |
| Back | Home | |

5. Push  or  to select [C1 Accel & Decel Time], then push .



| | | |
|------------------------------------|------|------------|
| 10:00 am | FWD | Parameters |
| C1 Accel & Decel Time ▶ | | |
| C2 S-Curve Characteristics | | |
| C3 Slip Compensation | | |
| C4 Torque Compensation | | |
| C6 Duty & Carrier Frequency | | |
| Back | Home | |

6. Push  or  to select C1-01, then push .

| | | |
|----------------------------|-------------|------------------|
| 10:00 am | FWD | Parameters |
| Acceleration Time 1 | | |
| C1-01 | 10.0 | (10.0)sec |
| Deceleration Time 1 | | |
| C1-02 | 10.0 | (10.0)sec |
| Acceleration Time 2 | | |
| C1-03 | 10.0 | (10.0)sec |
| Back | Home | |



7. Push  or  to select the specified digit, then push  or  to select the correct number.

| | | |
|---------------------|---------|------------|
| 10:00 am | FWD | Parameters |
| Acceleration Time 1 | | |
| C1-01 | 0010.0 | sec |
| Default : 10.0sec | | |
| Range : 0.0~6000.0 | | |
| Back | Default | Min/Max |

- Push  [Default] to set the parameter to factory default.
- Push  [Min/Max] to show the minimum value or the maximum value on the display.

8. Push  to keep the changes.

| | | |
|---------------------|---------|------------|
| 10:00 am | FWD | Parameters |
| Acceleration Time 1 | | |
| C1-01 | 0020.0 | sec |
| Default : 10.0 sec | | |
| Range : 0.0~6000.0 | | |
| Back | Default | Min/Max |

9. Continue to change parameters, then push  [Back],  [Home] to go back to the home screen after you change all the applicable parameters.

◆ Save a Backup of Parameters

You can save a backup of the drive parameters to the keypad. The keypad can store parameter setting values for a maximum of four drives in different storage areas. Parameter setting backups can save time when you set parameters after you replace a drive. If you

set up more than one drive, you can copy the parameter settings from a drive that completed a test run to the other drives.

Note:

- Stop the motor before you back up parameters.
- While you back up parameters, the drive will not accept Run commands.
- The DriveWorksEZ PC software password is necessary to back up *qx-xx* [DriveWorksEZ Parameters] and *rx-xx* [DWEZ Connection Parameters]. If you enter an incorrect password, the drive detects *PWEr* [DWEZ Password Mismatch].



1. Push **F2** (Home) to show the HOME screen.







Note:



- When the drive is in HOME Mode, the screen shows [Home] in the upper right-hand corner of the screen.
- If the screen does not show [Home] for **F2**, push **F1** (Back), and then push **F2** to show [Home].

2. Push **F2** (Menu).



| | | | |
|---------------------|-----|-----|------|
| 10:00 am | FWD | Rdy | Home |
| Freq Reference (AI) | | | 0.00 |
| U1-01 | Hz | | 0.00 |
| Output Frequency | | | 0.00 |
| U1-02 | Hz | | 0.00 |
| Output Current | | | 0.00 |
| U1-03 | A | | 0.00 |
| Menu | | | |

3. Push  or  to select [Parameter Backup/Restore], then push .



| | | |
|---|---------------------------------|------|
| 10:00 am | FWD | Menu |
|  | Monitors | |
|  | Parameters | |
|  | User Custom Parameters | |
|  | Parameter Backup/Restore | ▶ |
|  | Modified Param / Fault Log | |
|  | Auto-Tuning | |
| Home | | |

4. Push  or  to select the items to back up, then push .

| | | |
|--------------------------------|----------------------------|--------|
| 10:00 am | FWD | Backup |
| Select Items to Backup/Restore | | |
| | Standard Parameters | ▶ |
| | | |
| Back | | Home |

5. Push  or  to select [Backup (drive → keypad)], then push .

| | | |
|-----------------------|--------------------------------|--------|
| 10:00 am | FWD | Backup |
| Select Desired Action | | |
| | Backup (drive → keypad) | ▶ |
| | Restore (keypad → drive) | |
| | Verify (check for mismatch) | |
| | Erase (backup data of keypad) | |
| Back | | Home |

6. Push  or  to select a memory location, then push .

| | | |
|--------------------------------|---------|---|
| 10:00 am | FWD | Backup |
| Select Backup/Restore Location | | |
| #1 | No Data |  |
| #2 | No Data | |
| #3 | No Data | |
| #4 | No Data | |
| Back | Home | |

The keypad shows “End” when the backup procedure completes successfully.

◆ Write Backed-up Parameters to the Drive



You can back up parameters on the keypad and write them to different drives.

Note:

- Always stop the drive before you start to restore the parameter backups.
- While you verify parameters, the drive will not accept Run commands.



1. Push  (Home) to show the HOME screen.







Note:



- When the drive is in HOME Mode, the screen shows [Home] in the upper right-hand corner of the screen.
- If the screen does not show [Home] for , push  (Back), and then push  to show [Home].

2. Push **F2** (Menu).



| | | |
|---------------------|---------|------|
| 10:00 am | FWD Rdy | Home |
| Freq Reference (AI) | | |
| U1-01 | Hz | 0.00 |
| Output Frequency | | |
| U1-02 | Hz | 0.00 |
| Output Current | | |
| U1-03 | A | 0.00 |
| Menu | | |

3. Push  or  to select [Parameter Backup/Restore], then push .



| | | |
|---|---------------------------------|------|
| 10:00 am | FWD | Menu |
|  | Monitors | |
|  | Parameters | |
|  | User Custom Parameters | |
|  | Parameter Backup/Restore | |
|  | Modified Param / Fault Log | |
|  | Auto-Tuning | |
| Home | | |

4. Push  or  to select the item to restore, then push .

| | | |
|--------------------------------|------|--------|
| 10:00 am | FWD | Backup |
| Select Items to Backup/Restore | | |
| Standard Parameters | | |
| | | |
| | | |
| Back | Home | |

5. Push  or  to select [Restore (keypad → drive)], then push .

| | | |
|-----------------------------------|------|--------|
| 10:00 am | FWD | Backup |
| Select Desired Action | | |
| Backup (drive → keypad) | | |
| Restore (keypad → drive) ▶ | | |
| Verify (check for mismatch) | | |
| Erase (backup data of keypad) | | |
| Back | Home | |

6. Push  or  to select the backed-up parameter data, then push .

| | | |
|-----------------------------------|------|--------|
| 10:00 am | FWD | Backup |
| Select Backup/Restore Location | | |
| #1 2016/01/01 13:00 0-62 ▶ | | |
| #2 No Data | | |
| #3 No Data | | |
| #4 No Data | | |
| Back | Home | |

The keypad will show the “End” message when the write process is complete.

Note:

The keypad display changes when the settings and conditions change.

| | | A | B | C |
|---|-----------------------|---|----|----------|
| | 10:00 am FWD | | | Backup |
| | Select Backup/Restore | | | Location |
| F | #1 2016/01/01 14:10 | 0 | 62 | ▶ |
| | #2 2016/01/01 02:10pm | 1 | 62 | * |
| E | #3 ----/--/-- --:-- | 2 | 62 | * |
| D | #4 No Data | | | |
| | Back | | | Home |

A - A1-02 [Control Method Selection] settings

B - o2-04 [Drive Model (KVA) Selection] settings (2 or 3 digits)

C - Presence of DriveWorksEZ parameter backup

D - Parameter backup data is not registered

E - Backup data does not contain the date information

F - Backup date

◆ Verify Keypad Parameters and Drive Parameters

This procedure makes sure that the parameter setting values that you backed up in the keypad agree with the parameter setting values in the drive.

Note:

- Always stop the drive before you start to verify the parameters.
- While you restore parameters, the drive will not accept Run commands.



1. Push **F2** (Home) to show the HOME screen.







Note:



- When the drive is in HOME Mode, the screen shows [Home] in the upper right-hand corner of the screen.
- If the screen does not show [Home] for **F2**, push **F1** (Back), and then push **F2** to show [Home].

2. Push **F2** (Menu).



| | |
|---------------------|------|
| 10:00 am FWD Rdy | Home |
| Freq Reference (AI) | 0.00 |
| U1-01 Hz | 0.00 |
| Output Frequency | 0.00 |
| U1-02 Hz | 0.00 |
| Output Current | 0.00 |
| U1-03 A | 0.00 |
| Menu | |

3. Push  or  to select [Parameter Backup/Restore], then push .



| | |
|---|------|
| 10:00 am FWD | Menu |
|  Monitors | |
|  Parameters | |
|  User Custom Parameters | |
|  Parameter Backup/Restore ▶ | |
|  Modified Param / Fault Log | |
|  Auto-Tuning | |
| Home | |

4. Push  or  to select the item to verify, then push .

| | | |
|--------------------------------|------|--------|
| 10:00 am | FWD | Backup |
| Select Items to Backup/Restore | | |
| Standard Parameters ▶ | | |
| | | |
| Back | Home | |

5. Push  or  to select [Verify (drive → keypad)], then push .

| | | |
|--------------------------------------|------|--------|
| 10:00 am | FWD | Backup |
| Select desired action. | | |
| ----- | | |
| Backup (drive → keypad) | | |
| Restore (keypad → drive) | | |
| Verify (check for mismatch) ▶ | | |
| Erase (backup data of keypad) | | |
| Back | Home | |

6. Push  or  to select the data to verify, then push .

| | | |
|-----------------------------------|------|--------|
| 10:00 am | FWD | Backup |
| Select Backup/Restore Location | | |
| #1 2016/01/01 13:00 0-62 ▶ | | |
| #2 No Data | | |
| #3 No Data | | |
| #4 No Data | | |
| Back | Home | |

The keypad shows “End” when the parameter settings backed up in the keypad agree with the parameter settings copied to the drive.

Note:

The keypad shows *vFyE [Parameters do not Match]* when the parameter settings backed up in the keypad do not agree with the parameter settings copied to the drive. Push one of the keys to return to the screen in Step 6.

◆ Delete Parameters Backed Up to the Keypad

This procedure deletes the parameters that you backed up to the keypad.



1. Push **F2** (Home) to show the HOME screen.







Note:



- When the drive is in HOME Mode, the screen shows [Home] in the upper right-hand corner of the screen.
- If the screen does not show [Home] for **F2**, push **F1** (Back), and then push **F2** to show [Home].

2. Push **F2** (Menu).



| | |
|---------------------|------|
| 10:00 am FWD Rdy | Home |
| Freq Reference (AI) | 0.00 |
| U1-01 Hz | 0.00 |
| Output Frequency | 0.00 |
| U1-02 Hz | 0.00 |
| Output Current | 0.00 |
| U1-03 A | 0.00 |
| Menu | |

3. Push  or  to select [Parameter Backup/Restore], then push .



| | |
|---|------|
| 10:00 am FWD | Menu |
|  Monitors | |
|  Parameters | |
|  User Custom Parameters | |
|  Parameter Backup/Restore ▶ | |
|  Modified Param / Fault Log | |
|  Auto-Tuning | |
| Home | |

4. Push  or  to select the item to delete, then push .

| | | |
|--------------------------------|------|--------|
| 10:00 am | FWD | Backup |
| Select Items to Backup/Restore | | |
| Standard Parameters ▶ | | |
| | | |
| Back | Home | |

5. Push  or  to select [Erase (backup data of keypad)], then push .

| | | |
|--|------|--------|
| 10:00 am | FWD | Backup |
| Select desired action. | | |
| ----- | | |
| Backup (drive → keypad) | | |
| Restore (keypad → drive) | | |
| Verify (check for mismatch) | | |
| Erase (backup data of keypad) ▶ | | |
| | | |
| Back | Home | |

6. Push  or  to select the data to delete, then push .

| | | |
|--------------------------------|--------------------|--------|
| 10:00 am | FWD | Backup |
| Select Backup/Restore Location | | |
| #1 | 2016/01/01 14:10 | 0-62 ▶ |
| #2 | 2016/01/01 02:10pm | 1-62 |
| #3 | ----/--/-- --:-- | 2-62 |
| #4 | No Data | |
| Back | Home | |



The keypad will show the “End” message when the write process is complete.

◆ Check Modified Parameters

This procedure will show all parameters that are not at their default values. You can also use this procedure to quickly access and edit changed parameters and is very useful when you replace a drive. When all parameters are at their default values, the keypad will show “0 Parameters”.



1. Push  (Home) to show the HOME screen.







Note:



- The keypad will show [Home] in the top right corner when the HOME screen is active.
- If [Home] is not shown on , push  (Back) to show [Home] on .



2. Push  (Menu).

| | |
|---------------------|------|
| 10:00 am FWD Rdy | Home |
| Freq Reference (AI) | 0.00 |
| U1-01 Hz | 0.00 |
| Output Frequency | 0.00 |
| U1-02 Hz | 0.00 |
| Output Current | 0.00 |
| U1-03 A | 0.00 |
| Menu | |

3. Push  or  to select [Modified Param / Fault Log], then push .



| | |
|---|------|
| 10:00 am FWD | Menu |
|  Monitors | |
|  Parameters | |
|  User Custom Parameters | |
|  Parameter Backup/Restore | |
|  Modified Param / Fault Log ▶ | |
|  Auto-Tuning | |
| Home | |

4. Push  or  to select [Modified Parameters], then push .



| | | |
|---|----------------------------|---|
| 10:00 am | FWD | History |
|  | Modified Parameters |  |
|  | Fault Log | |
| | | |
| Back | Home | |

5. Push .





| | | |
|----------------------------|------|----------|
| 10:00 am | FWD | Modified |
| User Modified Parameters | | |
| Standard Parameters | | |
| 2 Parameters | | |
| | | |
| Back | Home | |

6. Push  or  to show the parameter to check.

| | | |
|----------------------------|-------------|------------------|
| 10:00 am | FWD | Modified |
| Acceleration Time 1 | | |
| c1-01 | 20.0 | (10.0)sec |
| Motor Rated Current (FLA) | | |
| E2-01 | 97.2 | (77.2)A |
| | | |
| Back | Home | |

7. To re-edit a parameter, push  or , select the parameter to edit, then push .

| | | |
|----------------------------|-------------|------------------|
| 10:00 am | FWD | Modified |
| Acceleration Time 1 | | |
| C1-01 | 20.0 | (10.0)sec |
| Motor Rated Current (FLA) | | |
| E2-01 | 97.2 | (77.2)A |
| Back | Home | |

8. Push  or  to select the digit, then push  or  to change the value.

| | | |
|---------------------|----------------|------------|
| 10:00 am | FWD | Parameters |
| Acceleration Time 1 | | |
| C1-01 | 00 20.0 | sec |
| Default : 10.0sec | | |
| Range : 0.0~6000.0 | | |
| Back | Default | Min/Max |

9. When you are done changing the value, push .

| | | |
|---------------------|-----------------|------------|
| 10:00 am | FWD | Parameters |
| Acceleration Time 1 | | |
| C1-01 | 00 30 .0 | sec |
| Default : 10.0sec | | |
| Range : 0.0~6000.0 | | |
| Back | Default | Min/Max |



The parameter revision procedure is complete.

◆ Set Backlight to Automatically Turn OFF

You can set the backlight of the keypad screen to automatically turn OFF after a set length of time since the last key operation on the keypad. The procedure in this section shows how to turn ON and turn OFF the backlight.



1. Push  (Home) to show the HOME screen.







Note:



- The keypad will show [Home] in the top right corner when the HOME screen is active.
- If [Home] is not shown on , push  (Back) to show [Home] on .

2. Push  (Menu).



| | |
|---------------------|------|
| 10:00 am FWD Rdy | Home |
| Freq Reference (AI) | 0.00 |
| U1-01 Hz | 0.00 |
| Output Frequency | 0.00 |
| U1-02 Hz | 0.00 |
| Output Current | 0.00 |
| U1-03 A | 0.00 |
| Menu | |

3. Push  or  to select [Diagnostic Tools], then push .

| | |
|--|------|
| 10:00 am FWD | Menu |
|  User Custom Parameters | |
|  Parameter Backup/Restore | |
|  Modified Param / Fault Log | |
|  Auto-Tuning | |
|  Initial Setup | |
|  Diagnostic Tools | |
| Home | |

4. Push  or  to select [Backlight], then push .

| | | |
|--------------------|------|-------|
| 10:00 am | FWD | Tools |
| Data Logger | | |
| Backlight ▶ | | |
| Drive Information | | |
| Back | Home | Setup |

5. Push  or  to select [ON] or [OFF], then push .

| | | |
|--------------------------------|------|-------|
| 10:00 am | FWD | Tools |
| LCD backlight ON/OFF Selection | | |
| OFF | | |
| ON | | |
| Back | Home | |





- [ON]: Backlight is always ON
- [OFF]: Backlight turns OFF after set length of time.

6. Push  (Setup).

| | | |
|--------------------|------|-------|
| 10:00 am | FWD | Tools |
| Data Logger | | |
| Backlight ▶ | | |
| Drive Information | | |
| Back | Home | Setup |

7. Push .

| | | |
|--------------------------------|------|---------|
| 10:00 am | FWD | Setup |
| Energy Saving | | |
| Time to turn off LCD backlight | | |
| 01-38 | 60 | (60)sec |
| | | |
| Back | Home | |

8. Push  or  to select the digit, then push  or  to change the value.

| | | |
|--------------------------------|-------------|------------|
| 10:00 am | FWD | Parameters |
| Time to turn off LCD backlight | | |
| 01-38 | 0 60 | sec |
| Default : 60sec | | |
| Range : 10~300 | | |
| Back | Default | Min/Max |

9. When you are done changing the value, push .

| | | |
|--------------------------------|--------------|------------|
| 10:00 am | FWD | Parameters |
| Time to turn off LCD backlight | | |
| 01-38 | 0 3 0 | sec |
| Default : 60sec | | |
| Range : 10~300 | | |
| Back | Default | Min/Max |

The procedure to set the backlight to turn OFF automatically is complete.

◆ Show Information about the Drive

The procedure in this section shows how to show the drive model, maximum applicable motor output (HD/ND), rated output current (HD/ND), software version, and the serial number on the keypad.



1. Push **F2** (Home) to show the HOME screen.







Note:



- The keypad will show [Home] in the top right corner when the HOME screen is active.
- If [Home] is not shown on **F2**, push **F1** (Back) to show [Home] on **F2**.

2. Push **F2** (Menu).

| | | | |
|---------------------|-----|-----|------|
| 10:00 am | FWD | Rdy | Home |
| Freq Reference (AI) | | | 0.00 |
| U1-01 | Hz | | |
| Output Frequency | | | 0.00 |
| U1-02 | Hz | | |
| Output Current | | | 0.00 |
| U1-03 | A | | |
| Menu | | | |

3. Push  or  to select [Diagnostic Tools], then push .

| | | |
|---|----------------------------|------|
| 10:00 am | FWD | Menu |
|  | User Custom Parameters | |
|  | Parameter Backup/Restore | |
|  | Modified Param / Fault Log | |
|  | Auto-Tuning | |
|  | Initial Setup | |
|  | Diagnostic Tools ▶ | |
| Home | | |

4. Push  or  to select [Drive Information], then push .

| | | |
|----------------------------|------|-------|
| 10:00 am | FWD | Tools |
| Data Logger | | |
| Backlight | | |
| Drive Information ▶ | | |
| | | |
| Back | Home | |

The keypad will show the drive information.

| | | |
|----------------------|------|-------|
| 10:00 am | FWD | Tools |
| GA700 | | |
| 200v, 22.0/30.0kw | | |
| 88.00/110.0A | | |
| <VSAA01010> | | |
| S/N: J0065F575310100 | | |
| Back | Home | |

- A - Drive Series
 B - Maximum Applicable Motor Output (HD/ND)
 C - Rated Output Current (HD/ND)
 D - Drive Software Version
 E - Serial Number

7 Fault Diagnostics and Measures

◆ Fault Display

If a drive fault occurs when the keypad is connected to the drive, the keypad will show the fault code.

This section shows fault codes related to the keypad. For information regarding fault codes that do not appear in this table, refer to the instruction manual for the drive.

| Code | Name | Causes | Possible Solutions |
|-------|-------------------------|--|---|
| CPF00 | Control Circuit Error | Communication with the keypad is not possible seven seconds after power is turned on. | Refer to the following causes and solutions. |
| | | Keypad cable connector is not connected properly | <ul style="list-style-type: none"> Remove the keypad and connect it again. Replace the cable if damaged. |
| | | Faulty keypad | Replace the keypad. |
| | | Drive control circuit error | <ul style="list-style-type: none"> Re-energize the drive. Replace the drive. |
| CPF01 | Control Circuit Error | After start of communication with the keypad, a communication error occurred for approximately five seconds. | Refer to the following causes and solutions. |
| | | Keypad cable connector is not connected properly | Remove the keypad and connect it again. |
| | | Faulty keypad | Replace the keypad. |
| | | Drive control circuit error | <ul style="list-style-type: none"> Re-energize the drive. Replace the drive. |
| oPr | Keypad Connection Fault | The keypad is not securely connected to the connector on the drive. | Examine the connection between the keypad and the drive. |
| | | The connection cable between the drive and the keypad is disconnected. | <ul style="list-style-type: none"> Remove the keypad and then reconnect it. Replace the cable if damaged. |

| | | | |
|---|----------------------|--|---|
| - | - (No Error Message) | The cable is not securely connected. | Make sure that the cable is securely connected. |
| | | The connection cable between the drive and the keypad is disconnected. | Replace the cable if damaged. |
| | | Faulty keypad | Replace the keypad. |

8 Disposal Instructions

Correctly discard these parts and materials as specified by regional, local, and municipal laws and regulations for this product:

- Battery
- microSD card

⚠ CAUTION *Fire Hazard. Put electrical tape fully around the battery before you discard it. If you do not correctly discard the battery, it can cause a fire.*

Note:

- Remove the battery and microSD card from the keypad.
- You cannot recycle the battery. Discard used batteries as specified by the battery manufacturer.
- Customers are responsible for microSD card data protection. PC functions that format and delete the data may not be sufficient to fully erase the microSD card data. Yaskawa recommends that customers physically destroy the microSD card in a shredder or use data wipe software to fully erase the card.

◆ WEEE Directive



The wheelee bin symbol on this product, its manual, or its packaging identifies that you must recycle it at the end of its product life.

You must discard the product at an applicable collection point for electrical and electronic equipment (EEE). Do not discard the product with usual waste.

9 Specification

Table 9.1 Option Hardware Specifications (Common)

| Item | Description |
|---|---|
| Model | <ul style="list-style-type: none"> • Standard specifications: JVOP-KPLCA04Axx • Moisture resistance and dust resistance specifications: JVOP-KPLCA04Mxx • Gas resistance specifications: JVOP-KPLCA04Kxx |
| Port | RJ-45 |
| Power Supply | Supply from drive (DC +5 V \pm 5%) |
| Operating Ambient Temperature | -10 °C to +50 °C (14 °F to 122 °F) |
| Operating Ambient Humidity | 95% RH or less (no condensation) |
| Storage Ambient Temperature | -20 °C to +70 °C (-4 °F to +158 °F) (short-term storage temperature during transport) |
| Area of Use | Indoor (the area without corrosive gas, or dust) |
| Altitude | 1000 m (3281 ft.) maximum |
| Vibration | 10 to under 20 Hz: 1 G (9.8 m/s ²) 20 to under 55 Hz: 0.6 G (5.9 m/s ²) |
| Approximately Number of Parameter Reads | 100,000 or less |

Table 9.2 Moisture Resistance and Dust Resistance Specifications

| Item | Description |
|---------------|---|
| Model | JVOP-KPLCA04Mxx |
| Specification | Board surface: Apply insulating varnish (HumiSeal) to entire surface of the board excluding connectors. |

Table 9.3 Gas Resistance Specifications

| Item | Description |
|---------------|--|
| Model | JVOP-KPLCA04Kxx |
| Specification | <p>Board surface: Apply insulating varnish (HumiSeal) to entire surface of the board excluding connectors.</p> <p>Note:</p> <ul style="list-style-type: none"> • The gas resistance specifications have been tested and proper operation has been confirmed assuming the following environment. Pay sufficient attention to confirming that there are no problems with the installation environment. <ul style="list-style-type: none"> –Sulfurized gas (H₂S) Concentration <ul style="list-style-type: none"> –Maximum: 0.5 ppm –Average: 0.1 ppm –10 year equivalent • The battery and SD card do not apply gas resistance specifications. |

10 Warranty

◆ Warranty Period and Scope

■ Warranty Period

The warranty period is 12 months from the date the product is first used by the buyer, or 18 months from the date of shipment, whichever occurs first.

■ Post-Warranty Repair Period

The post-warranty repair period applies to products that are not in the standard warranty period. During the post-warranty repair period, Yaskawa will repair or replace damaged parts for a fee.

There is a limit to the period during which Yaskawa will repair or replace damaged parts. Contact Yaskawa or your nearest sales representative for more information.

■ Warranty Scope

- Failure diagnosis

In principle, Yaskawa requests that the primary fault diagnosis be conducted by your company. However, Yaskawa or our service network can conduct a fault diagnosis on behalf of your company for a fee, if requested. In this case, if the cause of the failure is determined to be the result of Yaskawa workmanship or materials based on discussions with the customer, this fault diagnosis will be free of charge.

- Repairs

If a Yaskawa product is found to be defective during the warranty period, Yaskawa will repair the defective product, provide a replacement, or visit the site free of charge. However, the customer will be responsible for the cost of any necessary repairs in the following cases.

- Problems due to improper storage or handling, carelessness, design content, or other reasons where you or your customers are determined to be responsible.
- Problems due to additions or modifications made to a Yaskawa product without Yaskawa's consent.
- Problems due to the use of a Yaskawa product under conditions that do not meet the range of recommended specifications for the product.
- Problems caused by events out of Yaskawa's control, such as natural disasters or fires.
- Problems after the free warranty period elapses.

- Defective products due to packaging or fumigation.
- Other problems not attributable to Yaskawa.

The above service is only available in Japan. After-sales service is available for overseas customers for a reasonable fee if using an overseas service contract.

■ Exceptions

Any opportunity loss to your company or damage to non-Yaskawa products, such as to you or your customers due to the failure of our products, or compensation for other business whether within or outside of the warranty period are not covered by warranty.

◆ About Application of This Product

This product is not designed or manufactured for use in life-support machines or systems.

Contact a Yaskawa representative or your Yaskawa sales representative if you are considering the application of this product for special purposes, such as machines or systems used for passenger cars, medicine, airplanes and aerospace, nuclear power, electric power, or undersea relaying.

⚠ WARNING *Injury to Personnel. When you use this product in applications where its failure could cause the loss of human life, a serious accident, or physical injury, you must install applicable safety devices. If you do not correctly install safety devices, it can cause serious injury or death.*

Revision History

| Date of Publication | Revision Number | Section | Revised Content |
|---------------------|---------------------------------|-----------|--|
| March 2019 | 2 | All | Revision: Reviewed and corrected entire documentation. |
| | | Chapter 1 | Addition: Compatible Models GA500 |
| | | Chapter 2 | |
| | | Chapter 5 | |
| Chapter 8 | Addition: Disposal Instructions | | |
| March 2019 | 1 | All | Revision: Reviewed and corrected entire documentation. |
| | | Chapter 1 | Addition: Compatible Models GA800 |
| | | Chapter 2 | |
| June 2017 | - | - | First Edition |

YASKAWA AC Drive Option LCD Keypad Installation Manual

DRIVE CENTER (INVERTER PLANT)

2-13-1, Nishimiyaichii, Yukuhashi, Fukuoka,
824-8511, Japan
Phone: +81-930-25-2548 Fax: +81-930-25-3431
<http://www.yaskawa.co.jp>

YASKAWA ELECTRIC CORPORATION

New Pier Takeshiba South Tower, 1-16-1, Kaigan,
Minatoku, Tokyo, 105-6891, Japan
Phone: +81-3-5402-4502 Fax: +81-3-5402-4580
<http://www.yaskawa.co.jp>

YASKAWA AMERICA, INC.

2121, Norman Drive South, Waukegan, IL 60085, U.S.A.
Phone: +1-800-YASKAWA (927-5292) or +1-847-887-7000
Fax: +1-847-887-7310
<http://www.yaskawa.com>

YASKAWA ELÉTRICO DO BRASIL LTDA.

777, Avenida Piraporinha, Diadema, São Paulo,
09950-000, Brasil
Phone: +55-11-3585-1100 Fax: +55-11-3585-1187
<http://www.yaskawa.com.br>

YASKAWA EUROPE GmbH

Hauptstraße 185, 65760 Eschborn, Germany
Phone: +49-6196-569-300 Fax: +49-6196-569-398
E-mail: info@yaskawa.eu.com
<http://www.yaskawa.eu.com>

YASKAWA ELECTRIC KOREA CORPORATION

35F, Three IFC, 10 Gukjegeumyung-ro,
Yeongdeungpo-gu, Seoul, 07326, Korea
Phone: +82-2-784-7844 Fax: +82-2-784-8495
<http://www.yaskawa.co.kr>

YASKAWA ASIA PACIFIC PTE. LTD.

30A, Kallang Place, #06-01, 339213, Singapore
Phone: +65-6282-3003 Fax: +65-6289-3003
<http://www.yaskawa.com.sg>

YASKAWA ELECTRIC (THAILAND) CO., LTD.

59, 1st-5th Floor, Flourish Building, Soi Ratchadapisek 18,
Ratchadapisek Road, Huaykwang, Bangkok, 10310,
Thailand
Phone: +66-2-017-0099 Fax: +66-2-017-0799
<http://www.yaskawa.co.th>

YASKAWA ELECTRIC (CHINA) CO., LTD.

22F, Link Square 1, No.222, Hubin Road, Shanghai,
200021, China
Phone: +86-21-5385-2200 Fax: +86-21-5385-3299
<http://www.yaskawa.com.cn>

YASKAWA ELECTRIC (CHINA) CO., LTD. BEIJING OFFICE

Room 1011, Tower W3 Oriental Plaza, No. 1,
East Chang An Ave.,
Dong Cheng District, Beijing, 100738, China
Phone: +86-10-8518-4086 Fax: +86-10-8518-4082

YASKAWA ELECTRIC TAIWAN CORPORATION

12F, No. 207, Sec. 3, Beishin Rd., Shindian Dist.,
New Taipei City 23143, Taiwan
Phone: +886-2-8913-1333
Fax: +886-2-8913-1513 or +886-2-8913-1519
<http://www.yaskawa.com.tw>

YASKAWA INDIA PRIVATE LIMITED

#17/A, Electronics City, Hosur Road, Bangalore,
560 100 (Karnataka), India
Phone: +91-80-4244-1900 Fax: +91-80-4244-1901
<http://www.yaskawaindia.in>

YASKAWA

YASKAWA ELECTRIC CORPORATION

In the event that the end user of this product is to be the military and said product is to be employed in any weapons systems or the manufacture thereof, the export will fall under the relevant regulations as stipulated in the Foreign Exchange and Foreign Trade Regulations. Therefore, be sure to follow all procedures and submit all relevant documentation according to any and all rules, regulations and laws that may apply.

Specifications are subject to change without notice for ongoing product modifications and improvements.

© 2017 YASKAWA Electric Corporation



T0EJPC73060097

MANUAL NO. TOEP C730600 97C <2>-0
Published in Japan March 2019
18-11-20