

Σ -7-Series AC Servo Drive

Σ -7S SERVOPACK

Command Option Attachable Type with INDEXER Module

Product Manual

SERVOPACK Model: SGD7S
Option Module Model: SGD7-OCA03A

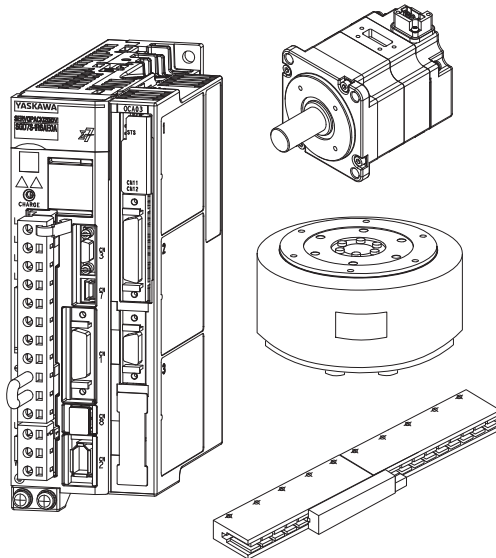

Basic Information	1
Selecting a SERVOPACK	2
Installation	3
Wiring and Connecting	4
Basic Functions That Require Setting before Operation	5
Application Functions	6
Trial Operation	7
Tuning	8
Monitoring	9
Fully-Closed Loop Control	10
Safety Functions	11
Settings for the INDEXER Module	12
Operation with Digital I/O	13
Operation with Serial Command Communications	14
Maintenance	15
Parameter Lists	16
Appendices	17

Copyright © 2015 YASKAWA ELECTRIC CORPORATION

All rights reserved. No part of this publication may be reproduced, stored in a retrieval system, or transmitted, in any form, or by any means, mechanical, electronic, photocopying, recording, or otherwise, without the prior written permission of Yaskawa. No patent liability is assumed with respect to the use of the information contained herein. Moreover, because Yaskawa is constantly striving to improve its high-quality products, the information contained in this manual is subject to change without notice. Every precaution has been taken in the preparation of this manual. Nevertheless, Yaskawa assumes no responsibility for errors or omissions. Neither is any liability assumed for damages resulting from the use of the information contained in this publication.

About this Manual

This manual provides information required to select Σ -7S Command Option Attachable-Type SERVOPACKs with INDEXER Modules for Σ -7-Series AC Servo Drives, and to design, perform trial operation of, tune, operate, and maintain the Servo Drives.

Read and understand this manual to ensure correct usage of the Σ -7-Series AC Servo Drives.

Keep this manual in a safe place so that it can be referred to whenever necessary.

Outline of Manual

The contents of the chapters of this manual are described in the following table.

Refer to these chapters as required.

Chapter	Chapter Title	Contents
1	Basic Information	Provides basic information, including an introduction to the INDEXER Module, the names of parts, and combinations with Servomotors.
2	Selecting a SERVOPACK	Provides information required to select SERVOPACKs, such as specifications, block diagrams, dimensional drawings, and connection examples.
3	Installation	Provides information on installing SERVOPACKs and INDEXER Modules in the required locations.
4	Wiring and Connecting	Provides information on wiring and connecting SERVOPACKs and INDEXER Modules to power supplies and peripheral devices.
5	Basic Functions That Require Setting before Operation	Describes the basic functions that must be set before you start servo system operation. It also describes the setting methods.
6	Application Functions	Describes the application functions that you can set before you start servo system operation. It also describes the setting methods.
7	Trial Operation	Provides information on the flow and procedures for trial operation and convenient functions to use during trial operation.
8	Tuning	Provides information on the flow of tuning, details on tuning functions, and related operating procedures.
9	Monitoring	Provides information on monitoring SERVOPACK product information and SERVOPACK status.
10	Fully-Closed Loop Control	Provides detailed information on performing fully-closed loop control with the SERVOPACK.
11	Safety Functions	Provides detailed information on the safety functions of the SERVOPACK.
12	Settings for the INDEXER Module	Provides detailed information on movement methods and coordinate settings, reference settings, and origin settings.
13	Operation with Digital I/O	Provides detailed information on homing, positioning with a program table, registration, constant speed operation with a jog speed table, and ZONE outputs.
14	Operation with Serial Command Communications	Provides information on using serial commands to operate the INDEXER Module.
15	Maintenance	Provides information on the meaning of, causes of, and corrections for alarms and warnings.
16	Parameter Lists	Provides information on the parameters.
17	Appendices	The appendix provides information on compatibility between SERVOPACK functions and SigmaWin+ functions, Digital Operator procedures, an alphabetized list of serial commands, and a table of corresponding parameter numbers.

Related Documents

The relationships between the documents that are related to the Servo Drives are shown in the following figure. The numbers in the figure correspond to the numbers in the table on the following pages. Refer to these documents as required.

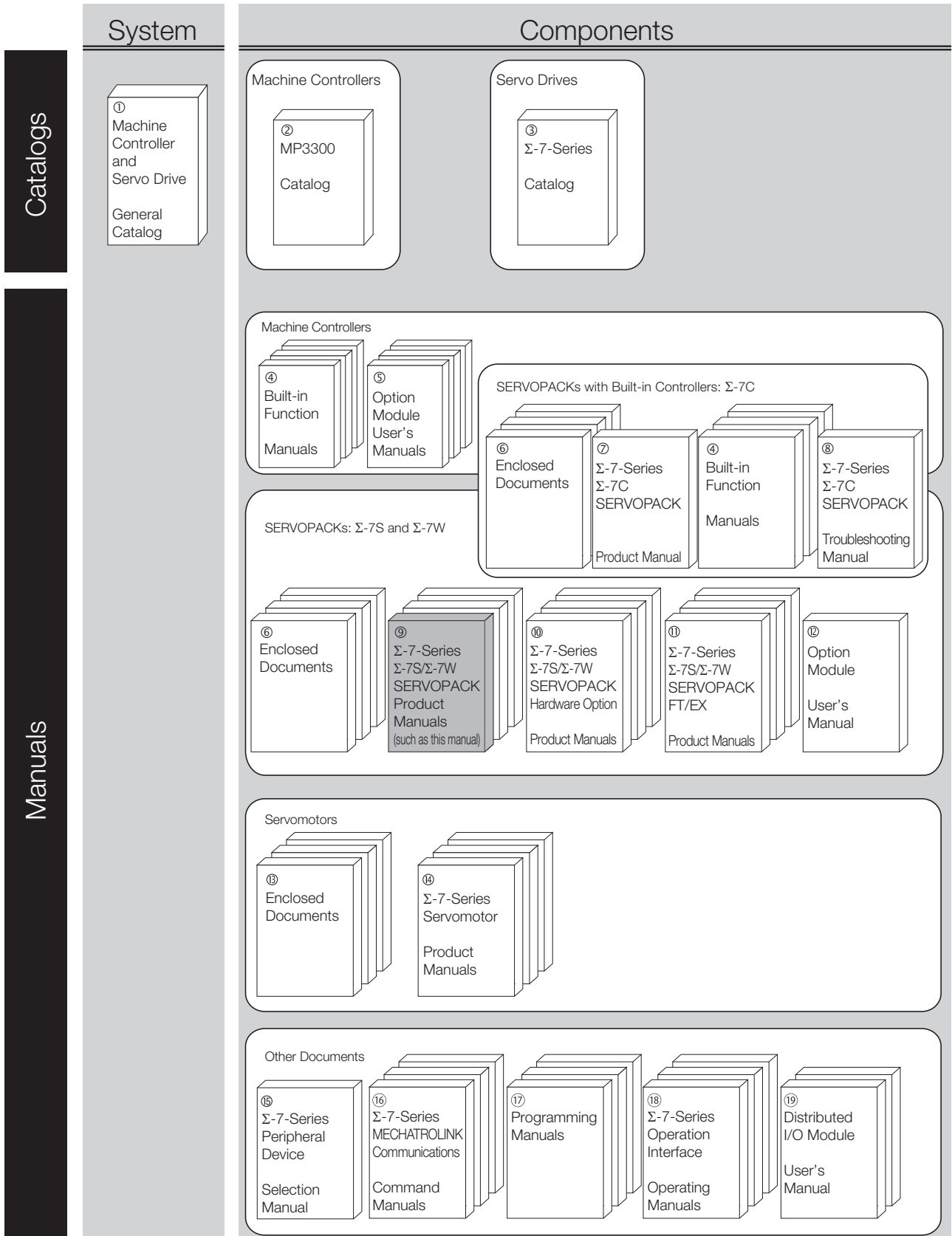

Classification	Document Name	Document No.	Description
① Machine Controller and Servo Drive General Catalog	Machine Controller and AC Servo Drive Solutions Catalog	KAEP S800001 22	Describes the features and application examples for combinations of MP3000-Series Machine Controllers and Σ -7-Series AC Servo Drives.
② MP3300 Catalog	Machine Controller MP3300	KAEP C880725 03	Provides detailed information on MP3300 Machine Controllers, including features and specifications.
③ Σ -7-Series Catalog	AC Servo Drives Σ -7 Series	KAEP S800001 23	Provides detailed information on Σ -7-Series AC Servo Drives, including features and specifications.
④ Built-in Function Manuals	Σ -7-Series AC Servo Drive Σ -7C SERVOPACK Motion Control User's Manual	SIEP S800002 03	Provides detailed information on the specifications, system configuration, and application methods of the Motion Control Function Modules (SVD, SVC4, and SVR4) for Σ -7-Series Σ -7C SERVOPACKs.
	Machine Controller MP3000 Series Communications User's Manual	SIEP C880725 12	Provides detailed information on the specifications, system configuration, and communications connection methods for the Ethernet communications that are used with MP3000-Series Machine Controllers and Σ -7-Series Σ -7C SERVOPACKs.
⑤ Option Module User's Manuals	Machine Controller MP2000 Series Communication Module User's Manual	SIEP C880700 04	Provide detailed information on the specifications and communications methods for the Communications Modules that can be mounted to MP3000-Series Machine Controllers and Σ -7-Series Σ -7C SERVOPACKs.
	Machine Controller MP2000 Series 262IF-01 FL-net Communication Module User's Manual	SIEP C880700 36	
	Machine Controller MP2000 Series 263IF-01 EtherNet/IP Communication Module User's Manual	SIEP C880700 39	
	Machine Controller MP2000 Series I/O Module User's Manual	SIEP C880700 34	
	Machine Controller MP2000 Series Analog Input/Analog Output Module AI-01/AO-01 User's Manual	SIEP C880700 26	
	Machine Controller MP2000 Series Counter Module CNTR-01 User's Manual	SIEP C880700 27	

Continued on next page.

Continued from previous page.

Classification	Document Name	Document No.	Description
⑥ Enclosed Documents	Σ-7-Series AC Servo Drive Σ-7S, Σ-7W, and Σ-7C SERVOPACK Safety Precautions	TOMP C710828 00	Provides detailed information for the safe usage of Σ-7-Series SERVOPACKS.
	Σ-V-Series/Σ-V-Series for Large-Capacity Models/ Σ-7-Series Safety Precautions Option Module	TOBP C720829 00	Provides detailed information for the safe usage of Option Modules.
	Σ-V-Series/Σ-V-Series for Large-Capacity Models/ Σ-7-Series Installation Guide Command Option Module	TOBP C720829 01	Provides detailed procedures for installing the Command Option Module in a SERVOPACK.
	Σ-V-Series/Σ-V-Series for Large-Capacity Models/ Σ-7-Series Installation Guide Fully-closed Module	TOBP C720829 03	Provides detailed procedures for installing the Fully-closed Module in a SERVOPACK.
	Σ-V-Series/Σ-V-Series for Large-Capacity Models/ Σ-7-Series Installation Guide Safety Module	TOBP C720829 06	Provides detailed procedures for installing the Safety Module in a SERVOPACK.
	Σ-V-Series/Σ-V-Series for Large-Capacity Models/ Σ-7-Series Installation Guide INDEXER Module	TOBP C720829 02	Provides detailed procedures for installing the INDEXER Module in a SERVOPACK.
	Σ-V-Series/Σ-V-Series for Large-Capacity Models/ Σ-7-Series Installation Guide DeviceNet Module	TOBP C720829 07	Provides detailed procedures for installing the DeviceNet Module in a SERVOPACK.
⑦ Σ-7-Series Σ-7C SERVOPACK Product Manual	Σ-7-Series AC Servo Drive Σ-7C SERVOPACK Product Manual	SIEP S800002 04	Provides detailed information on selecting Σ-7-Series Σ-7C SERVOPACKS; installing, connecting, setting, testing in trial operation, and tuning Servo Drives; writing, monitoring, and maintaining programs; and other information.
⑧ Σ-7-Series Σ-7C SERVOPACK Troubleshooting Manual	Σ-7-Series AC Servo Drive Σ-7C SERVOPACK Troubleshooting Manual	SIEP S800002 07	Provides detailed troubleshooting information for Σ-7-Series Σ-7C SERVOPACKS.

Continued on next page.

Continued from previous page.

Classification	Document Name	Document No.	Description
⑨ Σ-7-Series Σ-7S/Σ-7W SERVOPACK Product Manuals	Σ-7-Series AC Servo Drive Σ-7S SERVOPACK with MECHATROLINK-4 Communications References Product Manual	SIEP S800002 31	Provide detailed information on selecting Σ-7-Series Σ-7S and Σ-7W SERVOPACKs; installing, connecting, setting, testing in trial operation, tuning, monitoring, and maintaining Servo Drives; and other information.
	Σ-7-Series AC Servo Drive Σ-7S SERVOPACK with MECHATROLINK-III Communications References Product Manual	SIEP S800001 28	
	Σ-7-Series AC Servo Drive Σ-7S SERVOPACK with MECHATROLINK-II Communications References Product Manual	SIEP S800001 27	
	Σ-7-Series AC Servo Drive Σ-7S SERVOPACK with Analog Voltage/Pulse Train References Product Manual	SIEP S800001 26	
	Σ-7-Series AC Servo Drive Σ-7S SERVOPACK Command Option Attachable Type with INDEXER Module Product Manual	This manual (SIEP S800001 64)	
	Σ-7-Series AC Servo Drive Σ-7S SERVOPACK Command Option Attachable Type with DeviceNet Module Product Manual	SIEP S800001 70	
	Σ-7-Series AC Servo Drive Σ-7W SERVOPACK with MECHATROLINK-III Communications References Product Manual	SIEP S800001 29	
⑩ Σ-7-Series Σ-7S/Σ-7W SERVOPACK with Hardware Option Specifications Product Manuals	Σ-7-Series AC Servo Drive Σ-7S/Σ-7W SERVOPACK with Hardware Option Specifica- tions Dynamic Brake Product Manual	SIEP S800001 73	Provide detailed information on Hardware Options for Σ-7-Series SERVOPACKs.
	Σ-7-Series AC Servo Drive Σ-7W/Σ-7C SERVOPACK with Hardware Option Specifica- tions HWBB Function Product Manual	SIEP S800001 72	

Continued on next page.

Continued from previous page.

Classification	Document Name	Document No.	Description
⑩ Σ-7-Series Σ-7S/Σ-7W SERVOPACK FT/EX Product Manuals	Σ-7-Series AC Servo Drive Σ-7S SERVOPACK with FT/EX Specification for Index- ing Application Product Manual	SIEP S800001 84	Provide detailed information on the FT/EX Option for Σ-7-Series SERVOPACKs.
	Σ-7-Series AC Servo Drive Σ-7S SERVOPACK with FT/EX Specification for Track- ing Application Product Manual	SIEP S800001 89	
	Σ-7-Series AC Servo Drive Σ-7S SERVOPACK with FT/EX Specification for Application with Special Motor, SGM7D Motor Product Manual	SIEP S800001 91	
	Σ-7-Series AC Servo Drive Σ-7S SERVOPACK with FT/EX Specification for Press and Injection Molding Application Product Manual	SIEP S800001 94	
	Σ-7-Series AC Servo Drive Σ-7S SERVOPACK with FT/EX Specification for Transfer and Alignment Application Product Manual	SIEP S800001 95	
	Σ-7-Series AC Servo Drive Σ-7S SERVOPACK with FT/EX Specification for Torque/Force Assistance for Conveyance Application Product Manual	SIEP S800002 09	
	Σ-7-Series AC Servo Drive Σ-7S SERVOPACK with FT/EX Specification for Cutting Application Feed Shaft Motor Product Manual	SIEP S800002 10	
	Σ-7-Series AC Servo Drive Σ-7S SERVOPACK with Three-Point Latching for Conveyance Application Product Manual	SIEP S800002 17	
	Σ-7-Series AC Servo Drive Σ-7S SERVOPACK with FT/EX Specification for Semi-/Fully-Closed Loop Control Online Switching for Conveyance Application Product Manual	SIEP S800002 27	
	Σ-7-Series AC Servo Drive Σ-7W SERVOPACK with FT/EX Specification for Gantry Applications Product Manual	SIEP S800002 29	

Continued on next page.

Continued from previous page.

Classification	Document Name	Document No.	Description
⑩ Option Module User's Manual	AC Servo Drives Σ -V Series/ Σ -V Series for Large-Capacity Models/ Σ -7 Series User's Manual Safety Module	SIEP C720829 06	Provides detailed information required for the design and mainte- nance of a Safety Module.
⑪ Enclosed Documents	AC Servo Drive Rotary Servomotor Safety Precautions	TOBP C230260 00	Provides detailed information for the safe usage of Rotary Servomo- tors and Direct Drive Servomotors.
	AC Servomotor Linear Σ Series Safety Precautions	TOBP C230800 00	Provides detailed information for the safe usage of Linear Servomo- tors.
⑫ Σ -7-Series Servomotor Product Manuals	Σ -7-Series AC Servo Drive Rotary Servomotor Product Manual	SIEP S800001 36	Provide detailed information on selecting, installing, and connecting the Σ -7-Series Servomotors.
	Σ -7-Series AC Servo Drive Linear Servomotor Product Manual	SIEP S800001 37	
	Σ -7-Series AC Servo Drive Direct Drive Servomotor Product Manual	SIEP S800001 38	
⑬ Σ -7-Series Peripheral Device Selection Manual	Σ -7-Series AC Servo Drive Peripheral Device Selection Manual	SIEP S800001 32	Provides the following information in detail for Σ -7-Series Servo Sys- tems. <ul style="list-style-type: none"> • Cables: Models, dimensions, wir- ing materials, connector models, and connection specifications • Peripheral devices: Models, specifications, diagrams, and selection (calculation) methods
⑭ Σ -7-Series MECHATROLINK Communications Command Manuals	Σ -7-Series AC Servo Drive MECHATROLINK-II Communications Command Manual	SIEP S800001 30	Provides detailed information on the MECHATROLINK-II communi- cations commands that are used for a Σ -7-Series Servo System.
	Σ -7-Series AC Servo Drive MECHATROLINK-III Communications Standard Servo Profile Command Manual	SIEP S800001 31	Provides detailed information on the MECHATROLINK-III communi- cations standard servo profile com- mands that are used for a Σ -7- Series Servo System.
	Σ -7-Series AC Servo Drive MECHATROLINK-4 Communications Standard Servo Profile Command Manual	SIEP S800002 32	Provides detailed information on the MECHATROLINK-4 communi- cations standard servo profile com- mands that are used for a Σ -7-Series Servo System.
⑮ Programming Manuals	Machine Controller MP3000 Series Ladder Programming Manual	SIEP C880725 13	Provides detailed information on the ladder programming specifica- tions and instructions for MP3000- Series Machine Controllers and Σ -7-Series Σ -7C SERVOPACKs.
	Machine Controller MP3000 Series Motion Programming Manual	SIEP C880725 14	Provides detailed information on the motion programming and sequence programming specifica- tions and instructions for MP3000- Series Machine Controllers and Σ -7-Series Σ -7C SERVOPACKs.

Continued on next page.

Continued from previous page.

Classification	Document Name	Document No.	Description
¹⁸ Σ-7-Series Operation Interface Operating Manuals	System Integrated Engineering Tool MPE720 Version 7 User's Manual	SIEP C880761 03	Describes in detail how to operate MPE720 version 7.
	Σ-7-Series AC Servo Drive Digital Operator Operating Manual	SIEP S800001 33	Describes the operating procedures for a Digital Operator for a Σ-7-Series Servo System.
	AC Servo Drive Engineering Tool SigmaWin+ Operation Manual	SIET S800001 34	Provides detailed operating procedures for the SigmaWin+ Engineering Tool for a Σ-7-Series Servo System.
¹⁹ Distributed I/O Module User's Manual	MECHATROLINK-III Compatible I/O Module User's Manual	SIEP C880781 04	Describes the functions, specifications, operating methods, and MECHATROLINK-III communications for the Remote I/O Modules for MP2000/MP3000-Series Machine Controllers.
	MECHATROLINK-4 Compatible I/O Module User's Manual	SIEP C880782 01	Describes the functions, specifications, operating methods, and MECHATROLINK-4 communications for the Remote I/O Modules for MP3000-Series Machine Controllers.

Using This Manual

◆ Technical Terms Used in This Manual

The following terms are used in this manual.

Term	Meaning
Servomotor	A Σ -7-Series Rotary Servomotor, Direct Drive Servomotor, or Linear Servomotor.
Rotary Servomotor	A generic term used for a Σ -7-Series Rotary Servomotor (SGM7M, SGM7J, SGM7A, SGM7P, SGM7G, or SGMMV) or a Direct Drive Servomotor (SGM7E, SGM7F, SGMCV, or SGMCS). The descriptions will specify when Direct Drive Servomotors are excluded.
Linear Servomotor	A Σ -7-Series Linear Servomotor (SGLG, SGLF, or SGLT).
SERVOPACK	A Σ -7-Series Σ -7S Command Option Module Attachable-Type Servo Amplifier.
Servo Drive	The combination of a Servomotor and SERVOPACK.
Servo System	A servo control system that includes the combination of a Servo Drive with a host controller and peripheral devices.
servo ON	Supplying power to the motor.
servo OFF	Not supplying power to the motor.
base block (BB)	Shutting OFF the power supply to the motor by shutting OFF the base current to the power transistor in the SERVOPACK.
servo lock	A state in which the motor is stopped and is in a position loop with a position reference of 0.
Main Circuit Cable	One of the cables that connect to the main circuit terminals, including the Main Circuit Power Supply Cable, Control Power Supply Cable, and Servomotor Main Circuit Cable.
SigmaWin+	The Engineering Tool for setting up and tuning Servo Drives or a computer in which the Engineering Tool is installed.

◆ Differences in Terms for Rotary Servomotors and Linear Servomotors

There are differences in the terms that are used for Rotary Servomotors and Linear Servomotors. This manual primarily describes Rotary Servomotors. If you are using a Linear Servomotor, you need to interpret the terms as given in the following table.

Rotary Servomotors	Linear Servomotors
torque	force
moment of inertia	mass
rotation	movement
forward rotation and reverse rotation	forward movement and reverse movement
CW and CCW pulse trains	forward and reverse pulse trains
rotary encoder	linear encoder
absolute rotary encoder	absolute linear encoder
incremental rotary encoder	incremental linear encoder
unit: min^{-1}	unit: mm/s
unit: N·m	unit: N

◆ Notation Used in this Manual

■ Notation for Reverse Signals

The names of reverse signals (i.e., ones that are valid when low) are written with a forward slash (/) before the signal abbreviation.

Notation Example

\overline{BK} is written as /BK.

■ Notation for Parameters

The notation depends on whether the parameter requires a numeric setting (parameter for numeric setting) or requires the selection of a function (parameter for selecting functions).

• Parameters for Numeric Settings

Pn100	Speed Loop Gain				
	Setting Range	Setting Unit	Default Setting	When Enabled	Classification
	10 to 20,000	0.1 Hz	400	Immediately	Tuning

• Parameters for Selecting Functions

Parameter	Meaning	When Enabled	Classification
Pn002	n.□□□□ (default setting)	After restart	Setup
	n.□1□□		
	n.□2□□		

Notation Example

Notation Examples for Pn002

Notation	Digit Notation		Numeric Value Notation	
	Notation	Meaning	Notation	Meaning
n.0000	Pn002 = n.□□□X	Indicates the first digit from the right in Pn002.	Pn002 = n.□□□1	Indicates that the first digit from the right in Pn002 is set to 1.
	Pn002 = n.□□X□	Indicates the second digit from the right in Pn002.	Pn002 = n.□□1□	Indicates that the second digit from the right in Pn002 is set to 1.
	Pn002 = n.□X□□	Indicates the third digit from the right in Pn002.	Pn002 = n.□1□□	Indicates that the third digit from the right in Pn002 is set to 1.
	Pn002 = n.X□□□	Indicates the fourth digit from the right in Pn002.	Pn002 = n.1□□□	Indicates that the fourth digit from the right in Pn002 is set to 1.

◆ Engineering Tools Used in This Manual

This manual uses the interfaces of the SigmaWin+ for descriptions.

◆ Trademarks

- QR code is a trademark of Denso Wave Inc.
- Other product names and company names are the trademarks or registered trademarks of the respective company. “TM” and the ® mark do not appear with product or company names in this manual.

◆ Visual Aids

The following aids are used to indicate certain types of information for easier reference.



Indicates precautions or restrictions that must be observed.
Also indicates alarm displays and other precautions that will not result in machine damage.



Indicates definitions of difficult terms or terms that have not been previously explained in this manual.

Example Indicates operating or setting examples.

Information Indicates supplemental information to deepen understanding or useful information.

Safety Precautions

◆ Safety Information

To prevent personal injury and equipment damage in advance, the following signal words are used to indicate safety precautions in this document. The signal words are used to classify the hazards and the degree of damage or injury that may occur if a product is used incorrectly. Information marked as shown below is important for safety. Always read this information and heed the precautions that are provided.



DANGER

- Indicates precautions that, if not heeded, are likely to result in loss of life, serious injury, or fire.



WARNING

- Indicates precautions that, if not heeded, could result in loss of life, serious injury, or fire.



CAUTION

- Indicates precautions that, if not heeded, could result in relatively serious or minor injury, or in fire.

NOTICE

- Indicates precautions that, if not heeded, could result in property damage.

◆ Safety Precautions That Must Always Be Observed

■ General Precautions



DANGER

- Read and understand this manual to ensure the safe usage of the product.
- Keep this manual in a safe, convenient place so that it can be referred to whenever necessary. Make sure that it is delivered to the final user of the product.
- Do not remove covers, cables, connectors, or optional devices while power is being supplied to the SERVOPACK.
There is a risk of electric shock, operational failure of the product, or burning.



WARNING

- Use a power supply with specifications (number of phases, voltage, frequency, and AC/DC type) that are appropriate for the product.
There is a risk of burning, electric shock, or fire.
- Connect the ground terminals on the SERVOPACK and Servomotor to ground poles according to local electrical codes (100 Ω or less for a SERVOPACK with a 100-VAC or 200-VAC power supply, and 10 Ω or less for a SERVOPACK with a 400-VAC power supply).
There is a risk of electric shock or fire.
- Do not attempt to disassemble, repair, or modify the product.
There is a risk of fire or failure.
The warranty is void for the product if you disassemble, repair, or modify it.



CAUTION

- The SERVOPACK heat sinks, regenerative resistors, External Dynamic Brake Resistors, Servomotors, and other components can be very hot while power is ON or soon after the power is turned OFF. Implement safety measures, such as installing covers, so that hands and parts such as cables do not come into contact with hot components.
There is a risk of burn injury.
- For a 24-VDC power supply, use a power supply device with double insulation or reinforced insulation.
There is a risk of electric shock.
- Do not damage, pull on, apply excessive force to, place heavy objects on, or pinch cables.
There is a risk of failure, damage, or electric shock.
- The person who designs the system that uses the hard wire base block safety function must have a complete knowledge of the related safety standards and a complete understanding of the instructions in this document.
There is a risk of injury, product damage, or machine damage.
- Do not use the product in an environment that is subject to water, corrosive gases, or flammable gases, or near flammable materials.
There is a risk of electric shock or fire.

NOTICE

- Do not attempt to use a SERVOPACK or Servomotor that is damaged or that has missing parts.
- Install external emergency stop circuits that shut OFF the power supply and stops operation immediately when an error occurs.
- In locations with poor power supply conditions, install the necessary protective devices (such as AC reactors) to ensure that the input power is supplied within the specified voltage range. There is a risk of damage to the SERVOPACK.
- Use a Noise Filter to minimize the effects of electromagnetic interference. Electronic devices used near the SERVOPACK may be affected by electromagnetic interference.
- Always use a Servomotor and SERVOPACK in one of the specified combinations.
- Do not touch a SERVOPACK or Servomotor with wet hands. There is a risk of product failure.

■ Storage Precautions



CAUTION

- Do not place an excessive load on the product during storage. (Follow all instructions on the packages.) There is a risk of injury or damage.

NOTICE

- Do not install or store the product in any of the following locations.
 - Locations that are subject to direct sunlight
 - Locations that are subject to ambient temperatures that exceed product specifications
 - Locations that are subject to relative humidities that exceed product specifications
 - Locations that are subject to condensation as the result of extreme changes in temperature
 - Locations that are subject to corrosive or flammable gases
 - Locations that are near flammable materials
 - Locations that are subject to dust, salts, or iron powder
 - Locations that are subject to water, oil, or chemicals
 - Locations that are subject to vibration or shock that exceeds product specifications
 - Locations that are subject to radiation
- If you store or install the product in any of the above locations, the product may fail or be damaged.

■ Transportation Precautions



CAUTION

- Transport the product in a way that is suitable to the mass of the product.
- Do not use the eyebolts on a SERVOPACK or Servomotor to move the machine. There is a risk of damage or injury.
- When you handle a SERVOPACK or Servomotor, be careful of sharp parts, such as the corners. There is a risk of injury.
- Do not place an excessive load on the product during transportation. (Follow all instructions on the packages.) There is a risk of injury or damage.

NOTICE

- **Do not hold onto the front cover or connectors when you move a SERVOPACK.**
There is a risk of the SERVOPACK falling.
- **A SERVOPACK or Servomotor is a precision device. Do not drop it or subject it to strong shock.**
There is a risk of failure or damage.
- **Do not subject connectors to shock.**
There is a risk of faulty connections or damage.
- **If disinfectants or insecticides must be used to treat packing materials such as wooden frames, plywood, or pallets, the packing materials must be treated before the product is packaged, and methods other than fumigation must be used.**
Example: Heat treatment, where materials are kiln-dried to a core temperature of 56°C for 30 minutes or more.
If the electronic products, which include stand-alone products and products installed in machines, are packed with fumigated wooden materials, the electrical components may be greatly damaged by the gases or fumes resulting from the fumigation process. In particular, disinfectants containing halogen, which includes chlorine, fluorine, bromine, or iodine can contribute to the erosion of the capacitors.
- **Do not overtighten the eyebolts on a SERVOPACK or Servomotor.**
If you use a tool to overtighten the eyebolts, the tapped holes may be damaged.

■ Installation Precautions



CAUTION

- **Install the Servomotor or SERVOPACK in a way that will support the mass given in technical documents.**
- **Install SERVOPACKs, Servomotors, regenerative resistors, and External Dynamic Brake Resistors on nonflammable materials.**
Installation directly onto or near flammable materials may result in fire.
- **Provide the specified clearances between the SERVOPACK and the control panel as well as with other devices.**
There is a risk of fire or failure.
- **Install the SERVOPACK in the specified orientation.**
There is a risk of fire or failure.
- **Do not step on or place a heavy object on the product.**
There is a risk of failure, damage, or injury.
- **Do not allow any foreign matter to enter the SERVOPACK or Servomotor.**
There is a risk of failure or fire.

NOTICE

- **Do not install or store the product in any of the following locations.**
 - Locations that are subject to direct sunlight
 - Locations that are subject to ambient temperatures that exceed product specifications
 - Locations that are subject to relative humidities that exceed product specifications
 - Locations that are subject to condensation as the result of extreme changes in temperature
 - Locations that are subject to corrosive or flammable gases
 - Locations that are near flammable materials
 - Locations that are subject to dust, salts, or iron powder
 - Locations that are subject to water, oil, or chemicals
 - Locations that are subject to vibration or shock that exceeds product specifications
 - Locations that are subject to radiationIf you store or install the product in any of the above locations, the product may fail or be damaged.
- **Use the product in an environment that is appropriate for the product specifications.**

If you use the product in an environment that exceeds product specifications, the product may fail or be damaged.
- **A SERVOPACK or Servomotor is a precision device. Do not drop it or subject it to strong shock.**

There is a risk of failure or damage.
- **Always install a SERVOPACK in a control panel.**
- **Do not allow any foreign matter to enter a SERVOPACK or a Servomotor with a Cooling Fan and do not cover the outlet from the Servomotor's cooling fan.**

There is a risk of failure.

■ Wiring Precautions



DANGER

- **Do not change any wiring while power is being supplied.**

There is a risk of electric shock or injury.



WARNING

- **Wiring and inspections must be performed only by qualified engineers.**

There is a risk of electric shock or product failure.
- **Check all wiring and power supplies carefully.**

Incorrect wiring or incorrect voltage application to the output circuits may cause short-circuit failures. If a short-circuit failure occurs as a result of any of these causes, the holding brake will not work. This could damage the machine or cause an accident that may result in death or injury.
- **Connect the AC and DC power supplies to the specified SERVOPACK terminals.**
 - Connect an AC power supply to the L1, L2, and L3 terminals and the L1C and L2C terminals on the SERVOPACK.
 - Connect a DC power supply to the B1/⊕ and ⊖2 terminals and the L1C and L2C terminals on the SERVOPACK.

There is a risk of failure or fire.
- **If you use a SERVOPACK with the Dynamic Brake Hardware Option, connect an External Dynamic Brake Resistor that is suitable for the machine and equipment specifications to the specified terminals.**

There is a risk of unexpected operation, machine damage, burning, or injury when an emergency stop is performed.



CAUTION

- Wait for at least six minutes after turning OFF the power supply (with a SERVOPACK for a 100-VAC input, wait for at least nine minutes) and then make sure that the CHARGE indicator is not lit before starting wiring or inspection work. Do not touch the power supply terminals while the CHARGE lamp is lit after turning OFF the power supply because high voltage may still remain in the SERVOPACK.
There is a risk of electric shock.
- Observe the precautions and instructions for wiring and trial operation precisely as described in this document.
Failures caused by incorrect wiring or incorrect voltage application in the brake circuit may cause the SERVOPACK to fail, damage the equipment, or cause an accident resulting in death or injury.
- Check the wiring to be sure it has been performed correctly.
Connectors and pin layouts are sometimes different for different models. Always confirm the pin layouts in technical documents for your model before operation.
There is a risk of failure or malfunction.
- Connect wires to power supply terminals and motor connection terminals securely with the specified methods and tightening torque.
Insufficient tightening may cause wires and terminal blocks to generate heat due to faulty contact, possibly resulting in fire.
- Use shielded twisted-pair cables or screened unshielded multi-twisted-pair cables for I/O Signal Cables and Encoder Cables.
- The maximum wiring length is 3 m for I/O Signal Cables, and 50 m for Encoder Cables or Servomotor Main Circuit Cables.
- Observe the following precautions when wiring the SERVOPACK's main circuit terminals.
 - Turn ON the power supply to the SERVOPACK only after all wiring, including the main circuit terminals, has been completed.
 - If a connector is used for the main circuit terminals, remove the main circuit connector from the SERVOPACK before you wire it.
 - Insert only one wire per insertion hole in the main circuit terminals.
 - When you insert a wire, make sure that the conductor wire (e.g., whiskers) does not come into contact with adjacent wires.
- Install molded-case circuit breakers and other safety measures to provide protection against short circuits in external wiring.
There is a risk of fire or failure.

NOTICE

- Whenever possible, use the Cables specified by Yaskawa.
If you use any other cables, confirm the rated current and application environment of your model and use the wiring materials specified by Yaskawa or equivalent materials.
- Securely tighten connector screws and lock mechanisms.
Insufficient tightening may result in connectors falling off during operation.
- Do not bundle power lines (e.g., the Main Circuit Cable) and low-current lines (e.g., the I/O Signal Cables or Encoder Cables) together or run them through the same duct. If you do not place power lines and low-current lines in separate ducts, separate them by at least 30 cm.
If the cables are too close to each other, malfunctions may occur due to noise affecting the low-current lines.
- Install a battery at either the host controller or on the Encoder Cable.
If you install batteries both at the host controller and on the Encoder Cable at the same time, you will create a loop circuit between the batteries, resulting in a risk of damage or burning.
- When connecting a battery, connect the polarity correctly.
There is a risk of battery rupture or encoder failure.

■ Operation Precautions



WARNING

- Before starting operation with a machine connected, change the settings of the switches and parameters to match the machine.
Unexpected machine operation, failure, or personal injury may occur if operation is started before appropriate settings are made.
- Do not radically change the settings of the parameters.
There is a risk of unstable operation, machine damage, or injury.
- Install limit switches or stoppers at the ends of the moving parts of the machine to prevent unexpected accidents.
There is a risk of machine damage or injury.
- For trial operation, securely mount the Servomotor and disconnect it from the machine.
There is a risk of injury.
- Forcing the motor to stop for overtravel is disabled when the Jog, Origin Search, or Easy FFT utility function is executed. Take necessary precautions.
There is a risk of machine damage or injury.
- When an alarm occurs, the Servomotor will coast to a stop or stop with the dynamic brake according to the SERVOPACK Option and settings. The coasting distance will change with the moment of inertia of the load and the resistance of the External Dynamic Brake Resistor. Check the coasting distance during trial operation and implement suitable safety measures on the machine.
- Do not enter the machine's range of motion during operation.
There is a risk of injury.
- Do not touch the moving parts of the Servomotor or machine during operation.
There is a risk of injury.



CAUTION

- Design the system to ensure safety even when problems, such as broken signal lines, occur. For example, the P-OT and N-OT signals are set in the default settings to operate on the safe side if a signal line breaks. Do not change the polarity of this type of signal.
- When overtravel occurs, the power supply to the motor is turned OFF and the brake is released. If you use the Servomotor to drive a vertical load, set the Servomotor to enter a zero-clamped state after the Servomotor stops. Also, install safety devices (such as an external brake or counterweight) to prevent the moving parts of the machine from falling.
- Always turn OFF the servo before you turn OFF the power supply. If you turn OFF the main circuit power supply or control power supply during operation before you turn OFF the servo, the Servomotor will stop as follows:
 - If you turn OFF the main circuit power supply during operation without turning OFF the servo, the Servomotor will stop abruptly with the dynamic brake.
 - If you turn OFF the control power supply without turning OFF the servo, the stopping method that is used by the Servomotor depends on the model of the SERVOPACK. For details, refer to the manual for the SERVOPACK.
 - If you use a SERVOPACK with the Dynamic Brake Hardware Option, the Servomotor stopping methods will be different from the stopping methods used without the Option or with other Hardware Options. For details, refer to the following manual.
 Σ -7-Series Σ -7S/ Σ -7W SERVOPACK with Dynamic Brake Hardware Option Specifications Product Manual (Manual No.: SIEP S800001 73)
- Do not use the dynamic brake for any application other than an emergency stop.
There is a risk of failure due to rapid deterioration of elements in the SERVOPACK and the risk of unexpected operation, machine damage, burning, or injury.

NOTICE

- When you adjust the gain during system commissioning, use a measuring instrument to monitor the torque waveform and speed waveform and confirm that there is no vibration.
If a high gain causes vibration, the Servomotor will be damaged quickly.
- Do not frequently turn the power supply ON and OFF. After you have started actual operation, allow at least one hour between turning the power supply ON and OFF (as a guideline).
Do not use the product in applications that require the power supply to be turned ON and OFF frequently.
The elements in the SERVOPACK will deteriorate quickly.
- An alarm or warning may occur if communications are performed with the host controller while the SigmaWin+ or Digital Operator is operating.
If an alarm or warning occurs, it may interrupt the current process and stop the system.
- After you complete trial operation of the machine and facilities, use the SigmaWin+ to back up the settings of the SERVOPACK parameters. You can use them to reset the parameters after SERVOPACK replacement.
If you do not copy backed up parameter settings, normal operation may not be possible after a faulty SERVOPACK is replaced, possibly resulting in machine or equipment damage.

■ Maintenance and Inspection Precautions



DANGER

- Do not change any wiring while power is being supplied.
There is a risk of electric shock or injury.



WARNING

- Wiring and inspections must be performed only by qualified engineers.
There is a risk of electric shock or product failure.



CAUTION

- Wait for at least six minutes after turning OFF the power supply (with a SERVOPACK for a 100-VAC input, wait for at least nine minutes) and then make sure that the CHARGE indicator is not lit before starting wiring or inspection work. Do not touch the power supply terminals while the CHARGE lamp is lit after turning OFF the power supply because high voltage may still remain in the SERVOPACK.
There is a risk of electric shock.
- Before you replace a SERVOPACK, back up the settings of the SERVOPACK parameters. Copy the backed up parameter settings to the new SERVOPACK and confirm that they were copied correctly.
If you do not copy backed up parameter settings or if the copy operation is not completed normally, normal operation may not be possible, possibly resulting in machine or equipment damage.

NOTICE

- Discharge all static electricity from your body before you operate any of the buttons or switches inside the front cover of the SERVOPACK.
There is a risk of equipment damage.

■ Troubleshooting Precautions



DANGER

- If the safety device (molded-case circuit breaker or fuse) installed in the power supply line operates, remove the cause before you supply power to the SERVOPACK again. If necessary, repair or replace the SERVOPACK, check the wiring, and remove the factor that caused the safety device to operate.
There is a risk of fire, electric shock, or injury.



WARNING

- The product may suddenly start to operate when the power supply is recovered after a momentary power interruption. Design the machine to ensure human safety when operation restarts.
There is a risk of injury.



CAUTION

- When an alarm occurs, remove the cause of the alarm and ensure safety. Then reset the alarm or turn the power supply OFF and ON again to restart operation.
There is a risk of injury or machine damage.
- If the Servo ON signal is input to the SERVOPACK and an alarm is reset, the Servomotor may suddenly restart operation. Confirm that the servo is OFF and ensure safety before you reset an alarm.
There is a risk of injury or machine damage.
- Always insert a magnetic contactor in the line between the main circuit power supply and the main circuit power supply terminals on the SERVOPACK so that the power supply can be shut OFF at the main circuit power supply.
If a magnetic contactor is not connected when the SERVOPACK fails, a large current may flow, possibly resulting in fire.
- If an alarm occurs, shut OFF the main circuit power supply.
There is a risk of fire due to a regenerative resistor overheating as the result of regenerative transistor failure.
- Install a ground fault detector against overloads and short-circuiting or install a molded-case circuit breaker combined with a ground fault detector.
There is a risk of SERVOPACK failure or fire if a ground fault occurs.
- The holding brake on a Servomotor will not ensure safety if there is the possibility that an external force (including gravity) may move the current position and create a hazardous situation when power is interrupted or an error occurs. If an external force may cause movement, install an external braking mechanism that ensures safety.

■ Disposal Precautions

- Correctly discard the product as stipulated by regional, local, and municipal laws and regulations. Be sure to include these contents in all labelling and warning notifications on the final product as necessary.



■ General Precautions

- Figures provided in this document are typical examples or conceptual representations. There may be differences between them and actual wiring, circuits, and products.
- The products shown in illustrations in this document are sometimes shown without covers or protective guards. Always replace all covers and protective guards before you use the product.
- If you need a new copy of this document because it has been lost or damaged, contact your nearest Yaskawa representative or one of the offices listed on the back of this document.
- This document is subject to change without notice for product improvements, specifications changes, and improvements to the manual itself.
We will update the document number of the document and issue revisions when changes are made.
- Any and all quality guarantees provided by Yaskawa are null and void if the customer modifies the product in any way. Yaskawa disavows any responsibility for damages or losses that are caused by modified products.

Warranty

◆ Details of Warranty

■ Warranty Period

The warranty period for a product that was purchased (hereinafter called the “delivered product”) is one year from the time of delivery to the location specified by the customer or 18 months from the time of shipment from the Yaskawa factory, whichever is sooner.

■ Warranty Scope

Yaskawa shall replace or repair a defective product free of charge if a defect attributable to Yaskawa occurs during the above warranty period.

This warranty does not cover defects caused by the delivered product reaching the end of its service life and replacement of parts that require replacement or that have a limited service life.

This warranty does not cover failures that result from any of the following causes.

- Improper handling, abuse, or use in unsuitable conditions or in environments not described in product catalogs or manuals, or in any separately agreed-upon specifications
- Causes not attributable to the delivered product itself
- Modifications or repairs not performed by Yaskawa
- Use of the delivered product in a manner in which it was not originally intended
- Causes that were not foreseeable with the scientific and technological understanding at the time of shipment from Yaskawa
- Events for which Yaskawa is not responsible, such as natural or human-made disasters

◆ Limitations of Liability

- Yaskawa shall in no event be responsible for any damage or loss of opportunity to the customer that arises due to failure of the delivered product.
- Yaskawa shall not be responsible for any programs (including parameter settings) or the results of program execution of the programs provided by the user or by a third party for use with programmable Yaskawa products.
- The information described in product catalogs or manuals is provided for the purpose of the customer purchasing the appropriate product for the intended application. The use thereof does not guarantee that there are no infringements of intellectual property rights or other proprietary rights of Yaskawa or third parties, nor does it construe a license.
- Yaskawa shall not be responsible for any damage arising from infringements of intellectual property rights or other proprietary rights of third parties as a result of using the information described in catalogs or manuals.

◆ Suitability for Use

- It is the customer's responsibility to confirm conformity with any standards, codes, or regulations that apply if the Yaskawa product is used in combination with any other products.
- The customer must confirm that the Yaskawa product is suitable for the systems, machines, and equipment used by the customer.
- Consult with Yaskawa to determine whether use in the following applications is acceptable. If use in the application is acceptable, use the product with extra allowance in ratings and specifications, and provide safety measures to minimize hazards in the event of failure.
 - Outdoor use, use involving potential chemical contamination or electrical interference, or use in conditions or environments not described in product catalogs or manuals
 - Nuclear energy control systems, combustion systems, railroad systems, aviation systems, vehicle systems, medical equipment, amusement machines, and installations subject to separate industry or government regulations
 - Systems, machines, and equipment that may present a risk to life or property
 - Systems that require a high degree of reliability, such as systems that supply gas, water, or electricity, or systems that operate continuously 24 hours a day
 - Other systems that require a similar high degree of safety
- Never use the product for an application involving serious risk to life or property without first ensuring that the system is designed to secure the required level of safety with risk warnings and redundancy, and that the Yaskawa product is properly rated and installed.
- The circuit examples and other application examples described in product catalogs and manuals are for reference. Check the functionality and safety of the actual devices and equipment to be used before using the product.
- Read and understand all use prohibitions and precautions, and operate the Yaskawa product correctly to prevent accidental harm to third parties.

◆ Specifications Change

The names, specifications, appearance, and accessories of products in product catalogs and manuals may be changed at any time based on improvements and other reasons. The next editions of the revised catalogs or manuals will be published with updated code numbers. Consult with your Yaskawa representative to confirm the actual specifications before purchasing a product.

Compliance with UL Standards, EU Directives, UK Regulations, and Other Safety Standards

Certification marks for the standards for which the product has been certified by certification bodies are shown on nameplate. Products that do not have the marks are not certified for the standards. Refer to the Servomotor manual for compliant standards of Servomotors.

◆ North American Safety Standards (UL)



Product	Model	North American Safety Standards (UL File No.)
SERVOPACK	SGD7S	UL 61800-5-1 (E147823) CSA C22.2 No.274

◆ EU Directives



Product	Model	EU Directives	Harmonized Standards
SERVOPACK	SGD7S	Machinery Directive 2006/42/EC	EN ISO 13849-1: 2015 EN IEC 62061 EN 61800-5-2
		EMC Directive 2014/30/EU	EN 55011 Group 1, Class A EN 61000-6-2 EN 61000-6-4 EN 61800-3 (Category C2, Second environment)
		Low Voltage Directive 2014/35/EU	EN 61800-5-1
		RoHS Directive 2011/65/EU (EU)2015/863	EN IEC 63000

Note: 1. We declared the CE Marking based on the harmonized standards in the above table.

2. These products are for industrial use. In home environments, these products may cause electromagnetic interference and additional noise reduction measures may be necessary.

◆ UK Conformity Assessed (UKCA)



Product	Model	UK Regulations	Designated Standards
SERVOPACK	SGD7S	Supply of Machinery (Safety) Regulations S.I. 2008/1597	EN ISO 13849-1: 2015 EN IEC 62061 EN 61800-5-2
		Electromagnetic Compatibility Regulations S.I. 2016/1091	EN 55011 Group 1, Class A EN 61000-6-2 EN 61000-6-4 EN 61800-3 (Category C2, Second environment)
		Electrical Equipment (Safety) Regulations S.I. 2016/1101	EN 61800-5-1
		Restriction of the Use of Certain Hazardous Substances in Electrical and Electronic Equipment Regulations S.I. 2012/3032	EN IEC 63000

Note: We declared the UKCA marking based on the designated standards in the above table.

◆ Safety Standards

Product	Model	Safety Standards	Standards
SERVOPACK	SGD7S	Safety of Machinery	EN ISO 13849-1: 2015 EN 60204-1
		Functional Safety	EN 61508 series EN IEC 62061 EN 61800-5-2
		Functional Safety EMC	EN 61326-3-1 EN 61000-6-7

■ Safety Parameters

Item	Standards	Performance Level	
Safety Integrity Level	EN 61508	SIL3	
	EN IEC 62061	maximum SIL 3	
Mission Time	EN 61508	10 years	20 years
Probability of Dangerous Failure per Hour	EN 61508 EN IEC 62061	PFH = 4.04×10^{-9} [1/h] (4.04% of SIL3)	PFH = 4.05×10^{-9} [1/h] (4.05% of SIL3)
Performance Level	EN ISO 13849-1	PLe (Category 3)	
Mean Time to Dangerous Failure of Each Channel	EN ISO 13849-1	MTTFd: High	
Average Diagnostic Coverage	EN ISO 13849-1	DCavg: Medium	
Stop Category	EN 60204-1	Stop category 0	
Safety Function	EN 61800-5-2	STO	
Hardware Fault Tolerance	EN 61508	HFT = 1	
Subsystem	EN 61508	B	

Contents

About this Manual	iii
Outline of Manual	iii
Related Documents	iv
Using This Manual	xi
Safety Precautions	xiv
Warranty	xxiv
Compliance with UL Standards, EU Directives, UK Regulations, and Other Safety Standards	xxvi

1

Basic Information

1.1	The Σ-7 Series	1-3
1.2	Introduction to the INDEXER Module	1-4
1.2.1	Digital I/O	1-4
1.2.2	Serial Commands	1-6
1.3	Interpreting the Nameplate	1-7
1.3.1	SERVOPACK Nameplate	1-7
1.3.2	INDEXER Module Nameplate	1-7
1.4	Part Names	1-8
1.5	Interpreting Panel Displays	1-10
1.5.1	Panel Display	1-10
1.5.2	Indicators	1-11
1.6	Model Designations	1-12
1.6.1	Interpreting SERVOPACK Model Numbers	1-12
1.6.2	Interpreting INDEXER Module Model Numbers	1-13
1.6.3	Interpreting Servomotor Model Numbers	1-14
1.7	Combinations of SERVOPACKs and Servomotors	1-16
1.7.1	Combinations of Rotary Servomotors and SERVOPACKs	1-16
1.7.2	Combinations of Direct Drive Servomotors and SERVOPACKs	1-17
1.7.3	Combinations of Linear Servomotors and SERVOPACKs	1-19
1.8	Functions	1-21

2

Selecting a SERVOPACK

2.1	Ratings and Specifications	2-2
2.1.1	Ratings	2-2
2.1.2	Power Loss in the INDEXER Module	2-5
2.1.3	SERVOPACK Overload Protection Characteristics	2-6
2.1.4	Specifications	2-7

2.2	Block Diagrams	2-11
2.2.1	SGD7S-R70A, -R90A, and -1R6A	2-11
2.2.2	SGD7S-2R8A	2-11
2.2.3	SGD7S-3R8A, -5R5A, and -7R6A	2-12
2.2.4	SGD7S-120A	2-13
2.2.5	SGD7S-180A and -200A	2-15
2.2.6	SGD7S-330A	2-16
2.2.7	SGD7S-470A and -550A	2-17
2.2.8	SGD7S-590A and -780A	2-18
2.2.9	SGD7S-R70F, -R90F, and -2R1F	2-19
2.2.10	SGD7S-2R8F	2-19
2.3	External Dimensions	2-20
2.3.1	Front Cover Dimensions and Connector Specifications	2-20
2.3.2	SERVOPACK External Dimensions	2-20
2.3.3	INDEXER Module Dimensions and Connector Specifications	2-26
2.4	Examples of Standard Connections between SERVOPACKs and Peripheral Devices . .	2-27

3

Installation

3.1	Installation Precautions	3-2
3.2	Attaching the INDEXER Module to the SERVOPACK	3-3
3.3	Mounting Types and Orientation	3-4
3.4	Mounting Hole Dimensions	3-5
3.5	Mounting Interval	3-7
3.5.1	Installing One SERVOPACK in a Control Panel	3-7
3.5.2	Installing More Than One SERVOPACK in a Control Panel	3-7
3.6	Monitoring the Installation Environment	3-8
3.7	EMC Installation Conditions	3-9

4

Wiring and Connecting

4.1	Wiring and Connecting SERVOPACKs	4-3
4.1.1	General Precautions	4-3
4.1.2	Countermeasures against Noise	4-6
4.1.3	Grounding	4-9
4.2	Basic Wiring Diagrams	4-10

4.3	Wiring the Power Supply to the SERVOPACK	4-12
4.3.1	Terminal Symbols and Terminal Names	4-12
4.3.2	Wiring Procedure for Main Circuit Connector	4-14
4.3.3	Power ON Sequence	4-15
4.3.4	Power Supply Wiring Diagrams	4-17
4.3.5	Wiring Regenerative Resistors	4-23
4.3.6	Wiring Reactors for Harmonic Suppression	4-25
4.4	Wiring Servomotors	4-26
4.4.1	Terminal Symbols and Terminal Names	4-26
4.4.2	Pin Arrangement of Encoder Connector (CN2)	4-26
4.4.3	Wiring the SERVOPACK to the Encoder	4-27
4.4.4	Wiring the SERVOPACK to the Holding Brake	4-35
4.5	I/O Signal Connections	4-36
4.5.1	I/O Signal Connector (CN1)	4-36
4.5.2	Input Signal Connector (CN11)	4-40
4.5.3	I/O Circuits	4-43
4.6	Serial Command Communications Connector (CN12)	4-45
4.6.1	Connector Mode	4-45
4.6.2	Connector Signal Names	4-45
4.6.3	Connection Examples	4-46
4.6.4	Wiring Precautions	4-47
4.7	Connecting Safety Function Signals	4-48
4.7.1	Pin Arrangement of Safety Function Signals (CN8)	4-48
4.7.2	I/O Circuits	4-48
4.8	Connecting the Other Connectors	4-50
4.8.1	Serial Communications Connector (CN3)	4-50
4.8.2	Computer Connector (CN7)	4-50
4.8.3	Analog Monitor Connector (CN5)	4-50

5

Basic Functions That Require Setting before Operation

5.1	Manipulating Parameters (Pn□□□)	5-3
5.1.1	Parameter Classification	5-3
5.1.2	Notation for Parameters	5-4
5.1.3	Parameter Setting Methods	5-5
5.1.4	Write Prohibition Setting for Parameters	5-6
5.1.5	Initializing Parameter Settings	5-10
5.2	Power Supply Type Settings for the Main Circuit and Control Circuit . .	5-12
5.2.1	AC Power Supply Input/DC Power Supply Input Setting	5-12
5.2.2	Single-phase AC Power Supply Input/ Three-phase AC Power Supply Input Setting	5-13
5.3	Automatic Detection of Connected Motor	5-14
5.4	Motor Direction Setting	5-15
5.5	Setting the Linear Encoder Pitch	5-16
5.6	Writing Linear Servomotor Parameters	5-17

5.7	Selecting the Phase Sequence for a Linear Servomotor	5-21
5.8	Polarity Sensor Setting.	5-23
5.9	Polarity Detection.	5-24
5.9.1	Restrictions	5-24
5.9.2	Using the /S-ON (Servo ON) Signal to Perform Polarity Detection	5-25
5.9.3	Using a Tool Function to Perform Polarity Detection	5-26
5.10	Overtravel and Related Settings	5-27
5.10.1	Overtravel Signals	5-27
5.10.2	Overtravel Settings	5-28
5.10.3	Motor Stopping Method When Overtravel is Used.	5-28
5.10.4	Overtravel Warnings	5-29
5.11	Holding Brake.	5-31
5.11.1	Brake Operating Sequence	5-31
5.11.2	Allocating the /BK (Brake) Signal.	5-32
5.11.3	Output Timing of /BK (Brake) Signal When the Servomotor Is Stopped.	5-33
5.11.4	Output Timing of /BK (Brake) Signal When the Servomotor Is Operating	5-33
5.12	Motor Stopping Methods for Servo OFF and Alarms.	5-35
5.12.1	Stopping Method for Servo OFF	5-36
5.12.2	Servomotor Stopping Method for Alarms	5-36
5.13	Motor Overload Detection Level	5-39
5.13.1	Detection Timing for Overload Warnings (A.910)	5-39
5.13.2	Detection Timing for Overload Alarms (A.720)	5-40
5.14	Electronic Gear Settings	5-41
5.14.1	Electronic Gear Ratio Settings.	5-42
5.14.2	Electronic Gear Ratio Setting Examples	5-47
5.15	Resetting the Absolute Encoder	5-48
5.15.1	Precautions on Resetting.	5-48
5.15.2	Preparations	5-48
5.15.3	Applicable Tools	5-49
5.15.4	Operating Procedure	5-49
5.16	Setting the Origin of the Absolute Linear Encoder	5-51
5.16.1	Preparations	5-51
5.16.2	Applicable Tools	5-51
5.16.3	Operating Procedure	5-52
5.17	Setting the Regenerative Resistor Capacity	5-54

6 Application Functions

6.1	I/O Signals	6-3
6.1.1	Input Signals	6-3
6.1.2	Output Signals.	6-7
6.2	Operation for Momentary Power Interruptions	6-11
6.3	SEMI F47 Function	6-12

6.4	Setting the Motor Maximum Speed	6-14
6.5	Encoder Divided Pulse Output	6-15
6.5.1	Encoder Divided Pulse Output Signals	6-15
6.5.2	Setting for the Encoder Divided Pulse Output	6-20
6.6	Internal Torque Limits	6-22
6.7	Absolute Encoders	6-23
6.7.1	Connecting an Absolute Encoder	6-24
6.7.2	Multiturn Limit Setting	6-25
6.7.3	Multiturn Limit Disagreement Alarm (A.CC0)	6-26
6.8	Absolute Linear Encoders	6-29
6.8.1	Connecting an Absolute Linear Encoder	6-29
6.9	Software Reset	6-30
6.9.1	Preparations	6-30
6.9.2	Applicable Tools	6-30
6.9.3	Operating Procedure	6-30
6.10	Initializing the Vibration Detection Level	6-32
6.10.1	Preparations	6-32
6.10.2	Applicable Tools	6-33
6.10.3	Operating Procedure	6-33
6.10.4	Related Parameters	6-35
6.11	Adjusting the Motor Current Detection Signal Offset	6-36
6.11.1	Automatic Adjustment	6-36
6.11.2	Manual Adjustment	6-38
6.12	Overheat Protection	6-40
6.12.1	Connecting the Overheat Protection Input (TH) Signal	6-40
6.12.2	Overheat Protection Selection	6-42

7

Trial Operation

7.1	Flow of Trial Operation	7-2
7.1.1	Flow of Trial Operation for Rotary Servomotors	7-2
7.1.2	Flow of Trial Operation for Linear Servomotors	7-3
7.2	Inspections and Confirmations before Trial Operation	7-5
7.3	Trial Operation for the Servomotor without a Load	7-6
7.3.1	Preparations	7-6
7.3.2	Applicable Tools	7-7
7.3.3	Operating Procedure	7-7
7.4	Trial Operation with Digital I/O and Serial Communications . . .	7-9
7.5	Trial Operation with the Servomotor Connected to the Machine . .	7-11
7.5.1	Precautions	7-11
7.5.2	Preparations	7-11
7.5.3	Operating Procedure	7-12

7.6	Convenient Function to Use during Trial Operation	7-13
7.6.1	Program Jog Operation	7-13
7.6.2	Origin Search	7-19
7.6.3	Test without a Motor	7-21

8

Tuning

8.1	Overview and Flow of Tuning	8-4
8.1.1	Tuning Functions	8-5
8.1.2	Diagnostic Tool	8-5
8.2	Monitoring Methods	8-6
8.3	Precautions to Ensure Safe Tuning	8-7
8.3.1	Overtravel Settings	8-7
8.3.2	Torque Limit Settings	8-7
8.3.3	Setting the Position Deviation Overflow Alarm Level	8-7
8.3.4	Vibration Detection Level Setting	8-9
8.3.5	Setting the Position Deviation Overflow Alarm Level at Servo ON	8-9
8.4	Tuning-less Function	8-11
8.4.1	Application Restrictions	8-11
8.4.2	Operating Procedure	8-12
8.4.3	Troubleshooting Alarms	8-13
8.4.4	Parameters Disabled by Tuning-less Function	8-14
8.4.5	Automatically Adjusted Function Setting	8-14
8.4.6	Related Parameters	8-14
8.5	Estimating the Moment of Inertia	8-15
8.5.1	Outline	8-15
8.5.2	Restrictions	8-16
8.5.3	Applicable Tools	8-16
8.5.4	Operating Procedure	8-17
8.6	Autotuning without Host Reference	8-23
8.6.1	Outline	8-23
8.6.2	Restrictions	8-24
8.6.3	Applicable Tools	8-25
8.6.4	Operating Procedure	8-25
8.6.5	Troubleshooting Problems in Autotuning without a Host Reference	8-29
8.6.6	Automatically Adjusted Function Settings	8-31
8.6.7	Related Parameters	8-33
8.7	Autotuning with a Host Reference	8-34
8.7.1	Outline	8-34
8.7.2	Restrictions	8-35
8.7.3	Applicable Tools	8-35
8.7.4	Operating Procedure	8-36
8.7.5	Troubleshooting Problems in Autotuning with a Host Reference	8-39
8.7.6	Automatically Adjusted Function Settings	8-39
8.7.7	Related Parameters	8-40

8.8	Custom Tuning	8-41
8.8.1	Outline	8-41
8.8.2	Preparations	8-41
8.8.3	Applicable Tools	8-42
8.8.4	Operating Procedure	8-42
8.8.5	Automatically Adjusted Function Settings	8-47
8.8.6	Tuning Example for Tuning Mode 2 or 3	8-47
8.8.7	Related Parameters	8-48
8.9	Anti-Resonance Control Adjustment	8-49
8.9.1	Outline	8-49
8.9.2	Preparations	8-49
8.9.3	Applicable Tools	8-50
8.9.4	Operating Procedure	8-50
8.9.5	Related Parameters	8-52
8.9.6	Suppressing Different Vibration Frequencies with Anti-resonance Control.	8-52
8.10	Vibration Suppression	8-54
8.10.1	Outline	8-54
8.10.2	Preparations	8-55
8.10.3	Applicable Tools	8-55
8.10.4	Operating Procedure	8-55
8.10.5	Related Parameters	8-57
8.11	Speed Ripple Compensation	8-58
8.11.1	Outline	8-58
8.11.2	Setting Up Speed Ripple Compensation	8-58
8.11.3	Setting Parameters	8-62
8.12	Additional Adjustment Functions	8-64
8.12.1	Automatic Gain Switching	8-64
8.12.2	Friction Compensation	8-67
8.12.3	Gravity Compensation	8-69
8.12.4	Current Control Mode Selection	8-70
8.12.5	Current Gain Level Setting	8-70
8.12.6	Speed Detection Method Selection	8-71
8.12.7	Speed Feedback Filter	8-71
8.12.8	Backlash Compensation	8-71
8.13	Manual Tuning	8-73
8.13.1	Tuning the Servo Gains	8-73
8.13.2	Compatible Adjustment Functions	8-84
8.14	Diagnostic Tools	8-88
8.14.1	Mechanical Analysis	8-88
8.14.2	Easy FFT	8-89

9

Monitoring

9.1	Monitoring Product Information	9-2
9.1.1	Items That You Can Monitor	9-2
9.1.2	Operating Procedures	9-2
9.2	Monitoring SERVOPACK Status	9-3
9.2.1	Servo Drive Status	9-3
9.2.2	Monitoring Operation, Status, and I/O	9-3
9.2.3	I/O Signals Status Monitor	9-5
9.3	Monitoring Machine Operation Status and Signal Waveforms . .	9-7
9.3.1	Items That You Can Monitor	9-7
9.3.2	Using the SigmaWin+	9-8
9.3.3	Using the Analog Monitors	9-10
9.4	Monitoring Product Life	9-14
9.4.1	Items That You Can Monitor	9-14
9.4.2	Operating Procedure	9-15
9.4.3	Preventative Maintenance	9-16
9.5	Alarm Tracing	9-17
9.5.1	Data for Which Alarm Tracing Is Performed	9-17
9.5.2	Applicable Tools	9-17

10

Fully-Closed Loop Control

10.1	Fully-Closed System	10-2
10.2	SERVOPACK Commissioning Procedure	10-3
10.3	Parameter Settings for Fully-Closed Loop Control	10-5
10.3.1	Control Block Diagram for Fully-Closed Loop Control	10-5
10.3.2	Setting the Motor Direction and the Machine Movement Direction	10-5
10.3.3	Setting the Number of External Encoder Scale Pitches	10-6
10.3.4	Setting the PAO, PBO, and PCO (Encoder Divided Pulse Output) Signals . .	10-7
10.3.5	Electronic Gear Setting	10-8
10.3.6	Alarm Detection Settings	10-9
10.3.7	Analog Monitor Signal Settings	10-10
10.3.8	Setting to Use an External Encoder for Speed Feedback	10-10

11

Safety Functions

11.1	Introduction to the Safety Functions	11-2
11.1.1	Safety Functions	11-2
11.1.2	Precautions for Safety Functions	11-2

11.2	Hard Wire Base Block (HWBB)	11-3
11.2.1	Risk Assessment	11-3
11.2.2	Hard Wire Base Block (HWBB) State	11-4
11.2.3	Resetting the HWBB State	11-4
11.2.4	Detecting Errors in HWBB Signal	11-5
11.2.5	HWBB Input Signal Specifications	11-5
11.2.6	Operation without a Host Controller	11-5
11.2.7	/S-RDY (Servo Ready Output) Signal	11-6
11.2.8	/BK (Brake Output) Signal	11-6
11.2.9	Stopping Methods	11-7
11.2.10	ALM (Servo Alarm) Signal and /ALO1, /ALO2, and /ALO3 (Alarm Code Output) Signals	11-7
11.3	EDM1 (External Device Monitor)	11-8
11.3.1	EDM1 Output Signal Specifications	11-8
11.4	Applications Examples for Safety Functions	11-9
11.4.1	Connection Example	11-9
11.4.2	Failure Detection Method	11-9
11.4.3	Procedure	11-10
11.5	Validating Safety Functions	11-11
11.6	Connecting a Safety Function Device	11-12

12

Settings for the INDEXER Module

12.1	Moving Mode and Coordinate Settings	12-2
12.1.1	When the Coordinates are the Linear Type	12-2
12.1.2	When the Coordinates are the Rotary Type	12-3
12.2	Settings for References	12-4
12.2.1	Motor Speed	12-4
12.2.2	Acceleration Rate and Deceleration Rate	12-4
12.2.3	Smoothing	12-5
12.3	Origin Settings	12-6
12.3.1	When Using an Absolute Encoder	12-6
12.3.2	When Using an Incremental Encoder	12-7
12.4	Speed/Position Expansion Function Setting	12-8
12.4.1	Parameters	12-8
12.4.2	Serial Commands	12-8
12.4.3	Program Tables, ZONE Tables, and JOG Speed Tables	12-9
12.4.4	Parameter Editing Commands	12-11
12.4.5	Monitor Commands	12-11
12.4.6	Digital Operator Displays	12-12

13

Operation with Digital I/O

13.1	Operation Functions	13-3
13.2	Homing	13-4
13.2.1	I/O Signals Related to Homing	13-4
13.2.2	Parameters Related to Homing	13-5
13.2.3	Homing Procedures	13-7
13.3	Program Table Operation	13-9
13.3.1	Types of Operation	13-9
13.3.2	I/O Signals Related to Program Table Operation	13-11
13.3.3	Parameter Related to Program Table Operation	13-12
13.3.4	Program Table Configuration	13-12
13.3.5	Settings in the Program Table	13-13
13.3.6	SigmaWin+ Procedures	13-14
13.3.7	State Transitions	13-26
13.3.8	Program Table Operation Examples	13-27
13.3.9	EVENT Examples	13-42
13.3.10	Output Response Times after /START-STOP Turns ON	13-43
13.4	Jog Speed Table Operation	13-44
13.4.1	Input Signals Related to Jog Operation	13-44
13.4.2	Jog Speeds	13-44
13.4.3	Jog Speed Table and Speed Selection Signals	13-45
13.4.4	SigmaWin+ Procedures	13-45
13.4.5	Jog Speed Table Operation Example	13-50
13.4.6	Timing of Signal Changes	13-51
13.5	ZONE Outputs	13-52
13.5.1	ZONE Table and ZONE Signals	13-52
13.5.2	Parameters Related to ZONE Signals	13-54
13.5.3	SigmaWin+ Procedures	13-54
13.5.4	ZONE Output Application Example	13-61

14

Operation with Serial Command Communications

14.1	Introduction to Serial Command Communications	14-3
14.2	Communications Specifications for Serial Command Communications . .	14-4
14.3	Settings	14-5
14.3.1	Simplified Configuration Diagram	14-5
14.3.2	Setting the Axis Address	14-5
14.3.3	Parameters Related to Serial Communications	14-6
14.4	Command/Response Format	14-7
14.5	Global Commands	14-8
14.6	Echoback Response Time	14-9

14.7	Response Data Details	14-10
14.7.1	Positive Responses	14-10
14.7.2	Negative Responses	14-10
14.8	Serial Commands	14-11
14.8.1	Basic Operation Commands	14-11
14.8.2	Homing	14-12
14.8.3	Positioning, Jog Operation, and Registration with Serial Commands	14-15
14.8.4	Positioning with a Program Table	14-24
14.8.5	Editing a Jog Speed Table	14-29
14.8.6	Editing a ZONE Table	14-29
14.8.7	Editing Parameters, Monitoring, and Utility Functions	14-30

15

Maintenance

15.1	Inspections and Part Replacement	15-2
15.1.1	Inspections	15-2
15.1.2	Guidelines for Part Replacement	15-2
15.1.3	Replacing the Battery	15-3
15.2	Alarm Displays	15-5
15.2.1	List of Alarms	15-5
15.2.2	Troubleshooting Alarms	15-13
15.2.3	INDEXER Module Alarm Displays and Troubleshooting	15-46
15.2.4	Resetting INDEXER Alarms	15-49
15.2.5	Displaying the INDEXER Alarm History	15-51
15.2.6	Clearing the INDEXER Alarm History	15-52
15.2.7	Resetting Alarms Detected in Option Modules	15-53
15.2.8	Resetting Motor Type Alarms	15-55
15.3	Warning Displays	15-57
15.3.1	List of Warnings	15-57
15.3.2	Troubleshooting Warnings	15-59
15.3.3	INDEXER Module Error Displays and Troubleshooting	15-65
15.4	Troubleshooting Based on the Operation and Conditions of the Servomotor	15-73

16

Parameter Lists

16.1	Parameter Configurations	16-2
16.2	List of Parameters	16-3
16.2.1	Interpreting the Parameter Lists	16-3
16.2.2	List of Parameters	16-4
16.3	Parameter Recording Table	16-31

17

Appendices

17.1	Corresponding SERVOPACK and SigmaWin+ Function Names . .	17-2
	17.1.1 Corresponding SERVOPACK Utility Function Names	17-2
	17.1.2 Corresponding SERVOPACK Monitor Display Function Names	17-4
17.2	Operation of Digital Operator	17-8
	17.2.1 Overview	17-8
	17.2.2 Operation of Utility Functions	17-10
17.3	Alphabetical List of Serial Commands	17-31
17.4	Corresponding Parameter Numbers	17-34

Index

Revision History



Basic Information

1

This chapter provides basic information, including an introduction to the INDEXER Module, the names of parts, and combinations with Servomotors.

1.1	The Σ-7 Series	1-3
1.2	Introduction to the INDEXER Module	1-4
1.2.1	Digital I/O	1-4
1.2.2	Serial Commands	1-6
1.3	Interpreting the Nameplate	1-7
1.3.1	SERVOPACK Nameplate	1-7
1.3.2	INDEXER Module Nameplate	1-7
1.4	Part Names	1-8
1.5	Interpreting Panel Displays	1-10
1.5.1	Panel Display	1-10
1.5.2	Indicators	1-11
1.6	Model Designations	1-12
1.6.1	Interpreting SERVOPACK Model Numbers	1-12
1.6.2	Interpreting INDEXER Module Model Numbers	1-13
1.6.3	Interpreting Servomotor Model Numbers	1-14

1.7	Combinations of SERVOPACKs and Servomotors . .	1-16
1.7.1	Combinations of Rotary Servomotors and SERVOPACKs	1-16
1.7.2	Combinations of Direct Drive Servomotors and SERVOPACKs	1-17
1.7.3	Combinations of Linear Servomotors and SERVOPACKs	1-19
1.8	Functions	1-21

1.1 The Σ -7 Series

The Σ -7-series SERVOPACKs are designed for applications that require frequent high-speed and high-precision positioning. The SERVOPACK will make the most of machine performance in the shortest time possible, thus contributing to improving productivity.

The Σ -7-Series Command Option Attachable-Type SERVOPACKs can be combined with Σ -V-Series Option Modules to achieve the required control capabilities.



Note

This manual describes the application of a Command Option Attachable-type SERVOPACK used in combination with an INDEXER Module.

1.2 Introduction to the INDEXER Module

Note

- An INDEXER Module with a firmware version of 3 or higher is required to use the INDEXER Module with a Σ -7-Series SERVOPACK.
- An INDEXER Module can be attached only to a Command Option Attachable-type SERVOPACK.

The INDEXER Module is a single-axis positioning device that is equipped with a program table operation function. The INDEXER Module is mounted to the side of the SERVOPACK.

The INDEXER Module has two reference methods: digital I/O and serial commands. These command methods are described in the following sections.

1.2.1 Digital I/O

Digital I/O is used with a program table (mode 0) or a jog speed table (mode 1). You can use a program table (mode 0) to execute the program steps that you select with I/O signal patterns (binary format). If the jog speed table (mode 1) is being used, the jog speed selected with the input signal pattern (binary format) can be executed.

- Program Table

PGMSTEP	POS	SPD	RDST	RSPD	ACC	DEC	EVENT	LOOP	NEXT
0	I+400000	2000	500000	1000	200	100	T5000	1	1
1	I+100000	1000	200000	2000	100	50	IT0	1	END
⋮	⋮	⋮	⋮	⋮	⋮	⋮	⋮	⋮	⋮
n	I+400000	2000	500000	1000	100	50	IT100	1	n+1
n+1	I+100000	1000	200000	2000	⋮	⋮	NT0	1	END
⋮	⋮	⋮	⋮	⋮	⋮	⋮	⋮	⋮	⋮
254	I+400000	2000	500000	1000	100	50	SEL3T200	1	127
255	I+100000	1000	200000	2000	100	50	DT0	1	END

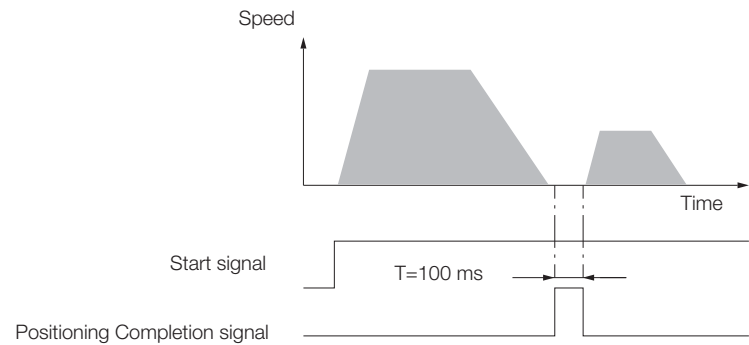

• Jog Speed Table

JSPD	JOG3	JOG2	JOG1	JOG0	Jog Speed
0	0	0	0	0	1000
1	0	0	0	1	2000
2	0	0	1	0	4000
⋮	⋮	⋮	⋮	⋮	⋮
⋮	⋮	⋮	⋮	⋮	⋮
⋮	⋮	⋮	⋮	⋮	⋮
15	1	1	1	1	5500

16 combinations

Note: 1: Signal is ON (active), 0: Signal is OFF (inactive).

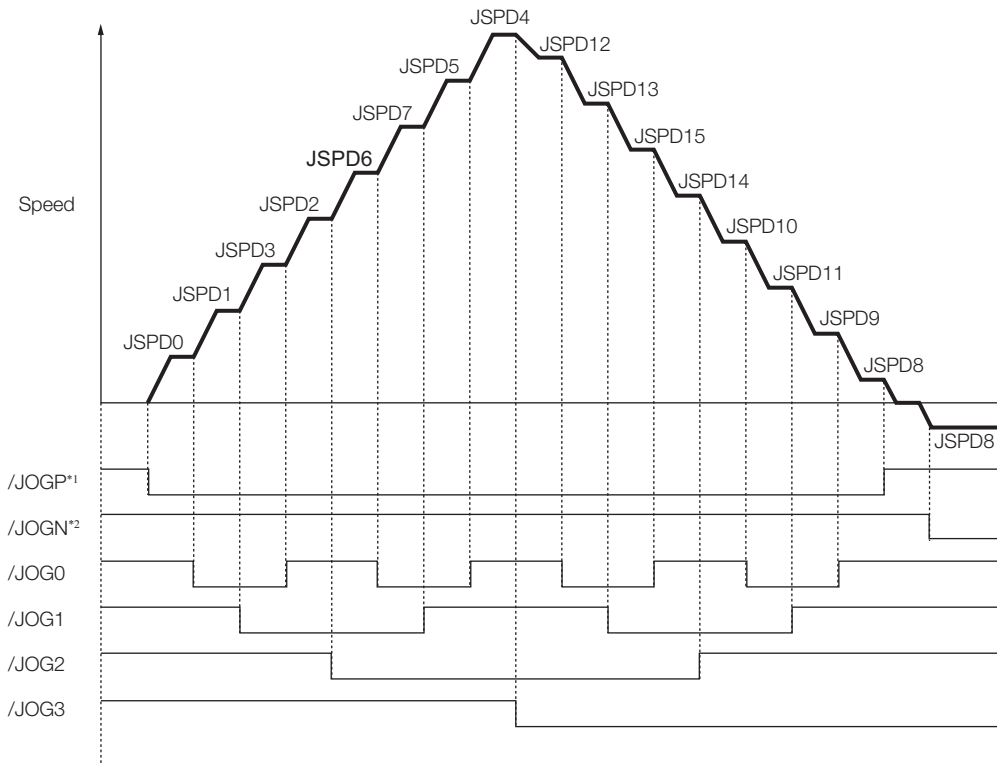

*1. Forward operation at the jog speed is performed while the /JOGP signal is ON.
 *2. Reverse operation at the jog speed is performed while the /JOGN signal is ON.

1.2.2 Serial Commands

With serial commands, ASCII command strings are sent to the INDEXER Module through RS-422 or RS-485 communications and these commands are interpreted and executed immediately. You can use general-purpose serial communications (RS422/RS485) to perform independent control of up to 16 axes from one host controller (e.g., PC or HMI).

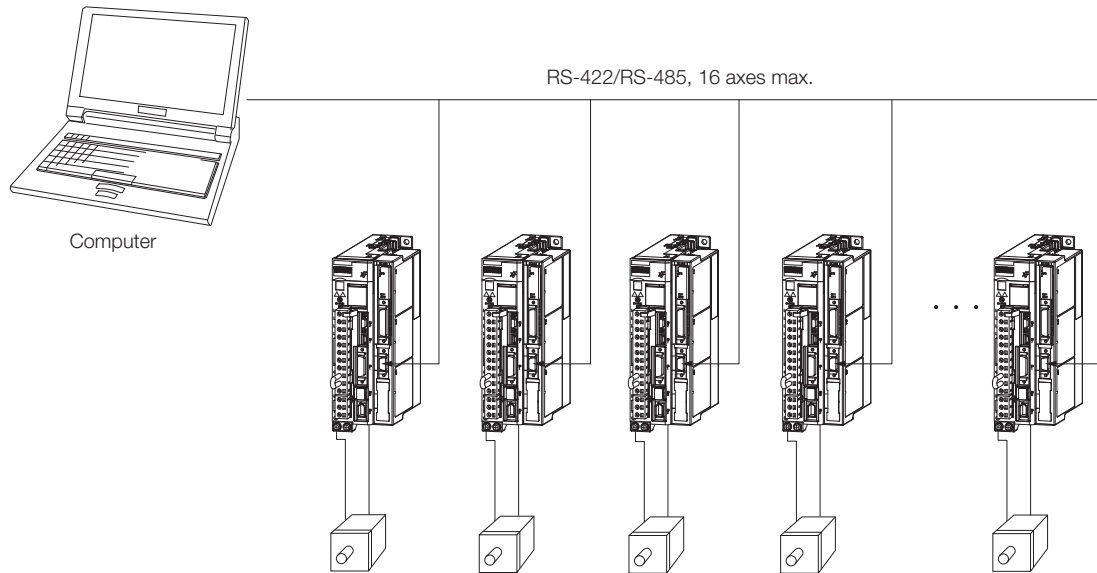

1SVON	# Servo turned ON.
1POSI=400000	# Set relative position to 400,000.
1SPD=2000	# Set speed to 2,000.
1ACC=200	# Set acceleration rate to 200.
1DEC=100	# Set deceleration rate to 100.
1ST	# Start operation.
:	

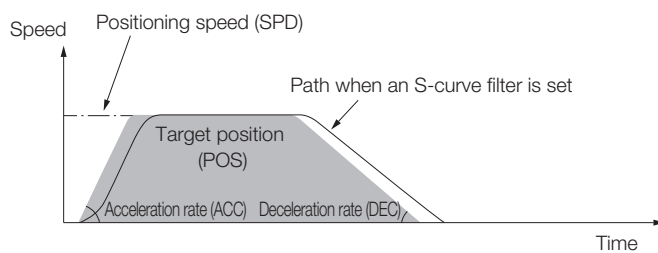

1.3 Interpreting the Nameplate

The following basic information is provided on the nameplate.

1.3.1 SERVOPACK Nameplate

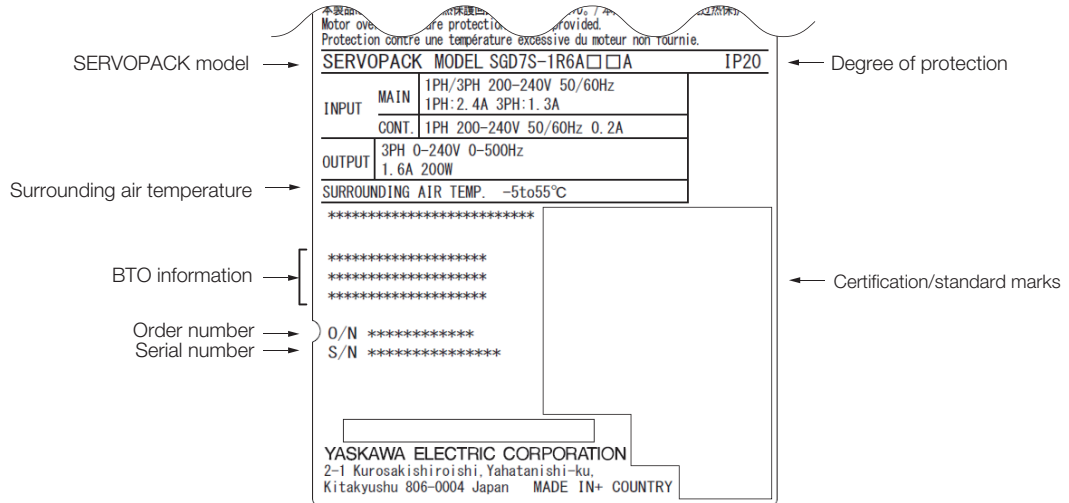

1.3.2 INDEXER Module Nameplate

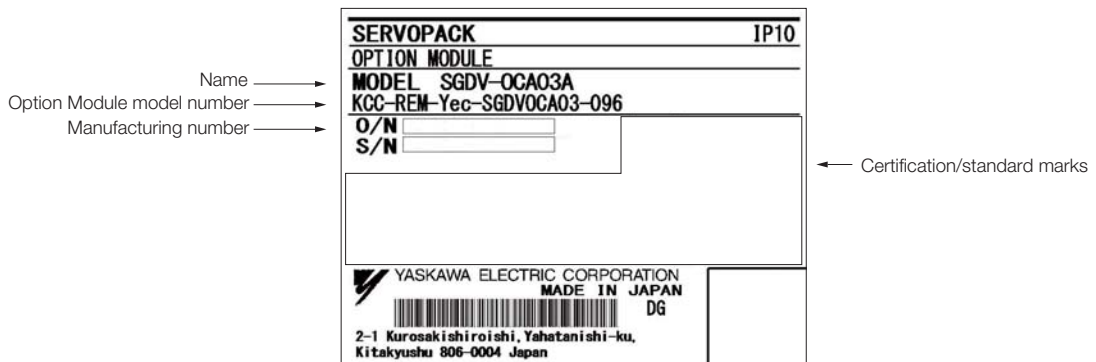

1.4 Part Names

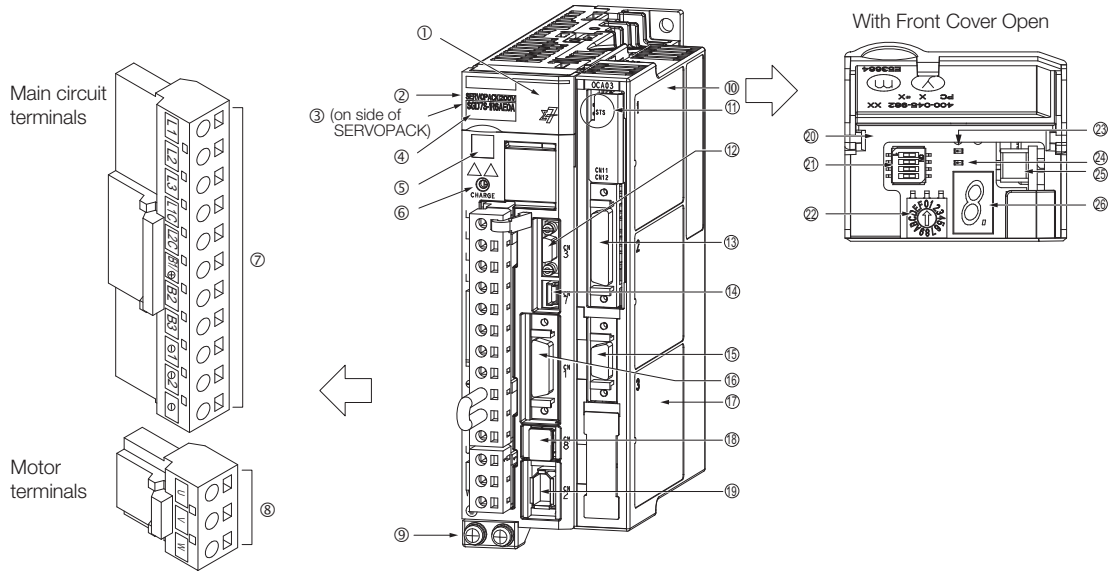

No.	Name	Description	Reference
①	Front Cover	—	—
②	Input Voltage	—	—
③	Nameplate	Indicates the SERVOPACK model and ratings.	page 1-5
④	Model	The model of the SERVOPACK.	page 1-12
⑤	QR Code	The QR code that is used by the MechatroCloud service.	—
⑥	CHARGE	Lit while the main circuit power is being supplied. Note: Even if you turn OFF the main circuit power supply, this indicator will be lit as long as the internal capacitor remains charged. Do not touch the main circuit or motor terminals while this indicator is lit. Doing so may result in electric shock.	—
⑦	Main Circuit Terminals	The terminals depend on the main circuit power supply input specifications of the SERVOPACK.	page 4-12
⑧	Servomotor Terminals (U, V, and W)	The connection terminals for the Servomotor Main Circuit Cable (power line).	page 4-26
⑨	Ground Terminal (⊕)	The ground terminals to prevent electric shock. Always connect this terminal.	—
⑩	INDEXER Module	—	—
⑪	Indicators	Light according to the status of the INDEXER Module.	page 1-13
⑫	Serial Communications Connector (CN3)	Connects to the Digital Operator (a peripheral device) or a computer (RS-422).	page 4-50
⑬	I/O Signal Connector (CN11)	Connects to sequence I/O signals.	page 4-40
⑭	Computer Connector (CN7)	A USB connector to connect a computer.	page 4-50
⑮	Serial Command Communications Connector (CN12)	Used for serial command communications.	page 4-45
⑯	I/O Signal Connector (CN1)	Connects to sequence I/O signals.	page 4-36
⑰	Feedback Option Module Connector	Connects to a Feedback Option Module.	—
⑱	Fully-Closed Option Module	This Option Module is connected to perform fully-closed control.	—
⑲	Safety Connector (CN8)	Connects to a safety function device.	page 4-48
⑲	Encoder Connector (CN2)	<ul style="list-style-type: none"> Rotary Servomotor: Connects to the encoder in the Servomotor. Linear Servomotor: Connects to a Serial Converter Unit or linear encoder. 	page 4-26
⑳	Serial Number	—	—

Continued on next page.

Continued from previous page.

No.	Name	Description	Reference
⑳	DIP Switch	Not used.	–
㉑	Rotary Switch	Not used.	–
㉒	PWR	Lights when the control power is being supplied.	–
㉓	COM	Not used. (Always not lit.)	–
㉔	Analog Monitor Connector (CN5)	You can use a special cable (peripheral device) to monitor the motor speed, torque reference, or other values.	page 4-50
㉕	Panel Display	Displays the servo status with a seven-segment display.	page 1-10

1.5 Interpreting Panel Displays

1.5.1 Panel Display

You can check the Servo Drive status on the panel display of the SERVOPACK.

Also, if an alarm or warning occurs, the alarm or warning number will be displayed. However, if $\square\square-\square\square$ appears on the panel display, the display will indicate a SERVOPACK communications error. Replace the SERVOPACK.

Interpreting Status Displays

The status is displayed as described below.

Display	Meaning	Display	Meaning
	Rotation Detection Display Lit if the Servomotor speed is higher than the setting of Pn502 or Pn581 and not lit if the speed is lower than the setting. (The default setting is 20 min ⁻¹ or 20 mm/s.)		Reference Input Display Lit while a reference is being input.
	Base Block Display Lit during the base block state (servo OFF). Not lit while the servo is ON.		Reference Option Module Communications Status Display Lit while communications with the Reference Option Module are normal.

Alarm and Warning Displays

If there is an alarm or warning, the display will change in the following order.

Example: Alarm A.020

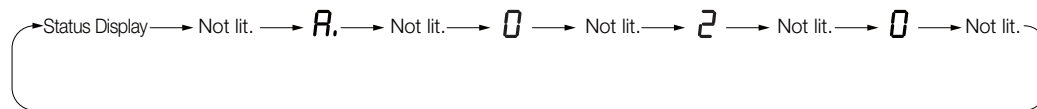

Hard Wire Base Block Active Display

If a hard wire base block (HWBB) is active, the display will change in the following order.

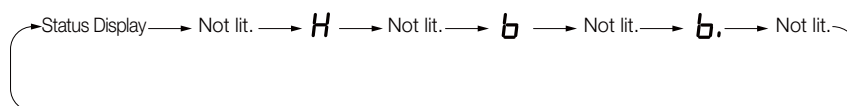

Overtravel and Software Limit Displays

If overtravel has occurred or if a software limit has been reached, the display will change in the following order.

① Forward Overtravel (P-OT) or Forward Software Limit (P-LS)



② Reverse Overtravel (N-OT) or Reverse Software Limit (N-LS)



③ Forward and Reverse Overtravel

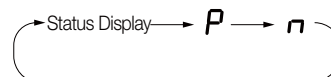

1.5.2 Indicators

This section describes the indicator status on the INDEXER Module.

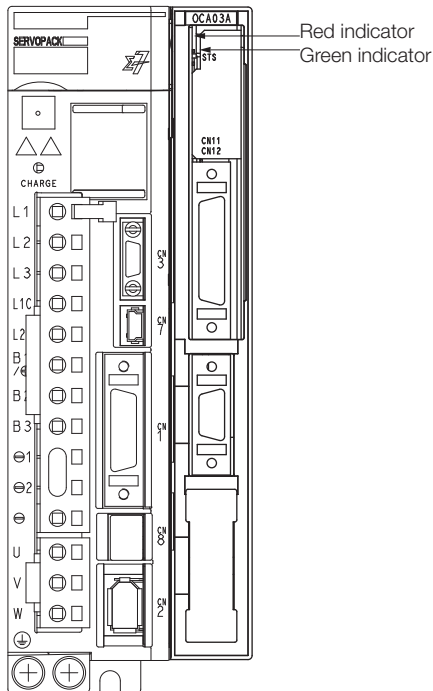

Status	Red indicator	Green indicator
Control Power Supply OFF	Not lit	Not lit
Control Power Supply ON	Not lit	Flashing
Normal	Not lit	Lit
Overtravel/Software Limit Activated		
Resetting	-	Flashing
Saving a Table		
Initializing a Table		
Initializing Parameters		
Error	Flashing (2 seconds)	-
Warning	Flashing	-
Alarm	Lit	Not lit

1.6 Model Designations

1.6.1 Interpreting SERVOPACK Model Numbers

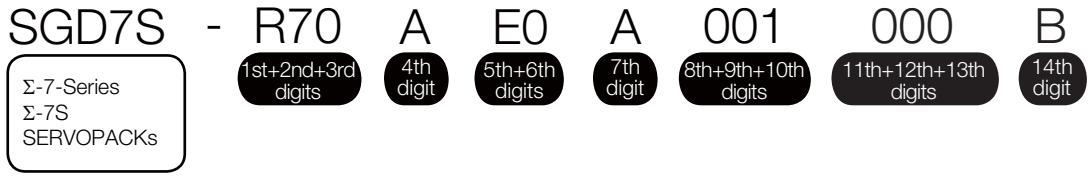

1st+2nd+3rd digits Maximum Applicable Motor Capacity

Voltage	Code	Specification
Three-Phase, 200 VAC	R70*1	0.05 kW
	R90*1	0.1 kW
	1R6*1	0.2 kW
	2R8*1	0.4 kW
	3R8	0.5 kW
	5R5*1	0.75 kW
	7R6	1.0 kW
	120*2	1.5 kW
	180	2.0 kW
	200	3.0 kW
	330	5.0 kW
	470	6.0 kW
	550	7.5 kW
590	11 kW	
780	15 kW	
Single-Phase, 100 VAC	R70	0.05 kW
	R90	0.1 kW
	2R1	0.2 kW
	2R8	0.4 kW

4th digit Voltage

Code	Specification
A	200 VAC
F	100 VAC

5th+6th digits Interface*3

Code	Specification
E0	Command option attachable type

7th digit Design Revision Order

A

8th+9th+10th digits Hardware Options Specification

Code	Specification	Applicable Models
None 000	Without options	All models
001	Rack-mounted	SGD7S-R70A to -330A SGD7S-R70F to -2R8F
	Duct-ventilated	SGD7S-470A to -780A
002	Varnished	All models
008	Single-phase, 200-VAC power supply input	SGD7S-120A
020*4	No dynamic brake	SGD7S-R70A to -2R8A SGD7S-R70F to -2R8F
	External dynamic brake resistor	SGD7S-3R8A to -780A

11th+12th+13th digits FT/EX Specification

Code	Specification
None 000	None

14th digit BTO Specification*5

Code	Specification
None	None
B	BTO specification

*1. You can use these models with either a single-phase or three-phase input.

*2. A model with a single-phase, 200-VAC power supply input is available as a hardware option (model: SGD7S-120A00A008).

*3. The same SERVOPACKs are used for both Rotary Servomotors and Linear Servomotors.

*4. Refer to the following manual for details.
 Σ-7-Series AC Servo Drive Σ-7S/Σ-7W SERVOPACK with Dynamic Brake Hardware Option Specifications Product Manual (Manual No.: SIEP S800001 73)

*5. The BTO specification indicates if the SERVOPACK is customized by using the MechatroCloud BTO service. This service is available on the e-mechatronics website. This service is available in Japan only. You need a BTO number to order SERVOPACKs with customized specifications. Refer to the following catalog for details on the BTO specification.
 AC Servo Drives Σ-7 Series (Manual No.: KAEP S800001 23)

1.6.2 Interpreting INDEXER Module Model Numbers

SGDV - OC A03 A

Σ-V-Series*1

1st+2nd
digits

3rd+4th+5th
digits

6th
digit

1st+2nd digits Module Type

Code	Specification
OC	Command option module

3rd+4th+5th digits Interface*2

Code	Specification
A03	INDEXER

6th digit Design Revision Order

A

*1. Σ-V-Series Modules are used with Σ-7-Series SERVOPACKs.

*2. The same INDEXER Module is used for both Rotary Servomotors and Linear Servomotors.

1.6.3 Interpreting Servomotor Model Numbers

This section outlines the model numbers of Σ -7-series Servomotors. Refer to the relevant manual in the following list for details.

📖 Σ -7-Series Rotary Servomotor Product Manual (Manual No.: SIEP S800001 36)

📖 Σ -7-Series Linear Servomotor Product Manual (Manual No.: SIEP S800001 37)

📖 Σ -7-Series Direct Drive Servomotor Product Manual (Manual No.: SIEP S800001 38)

Rotary Servomotors



Series Σ -7 Series Servomotors

Code	Specification
SGM7M	Low inertia , ultra-small capacity
SGM7J	Medium inertia, high speed
SGM7A	Low inertia, high speed
SGM7P	Medium inertia, flat
SGM7G	Medium inertia, low speed, high torque
SGMMV	Low inertia, ultra-small capacity

1st+2nd digits Rated Output

3rd digit Power Supply Voltage

- 200 VAC

4th digit Serial Encoder Specification

- 17-bit absolute encoder
- 20-bit absolute encoder
- 24-bit batteryless absolute encoder
- 24-bit absolute encoder
- 24-bit incremental encoder

5th digit Design Revision Order

6th digit Shaft End Specification

- Straight
- With key and tap
- With two flat seats

7th digit Option Specification

- With 24-V holding brake
- With oil seal

Direct Drive Servomotors



Series Σ -7 Series Servomotors

Code	Specification
SGM7E	Small capacity, coreless inner rotor
SGM7F	Small capacity, with core inner rotor
	Medium capacity, with core inner rotor
SGM7C	Small capacity, with core inner rotor
SGM7S	Small capacity, coreless inner rotor
	Medium capacity, with core inner rotor

1st+2nd digits Rated Torque

3rd digit Servomotor Outer Diameter

4th digit Serial Encoder Specification

5th digit Design Revision Order

6th digit Flange Specification

- Cable drawn to load side
- Cable drawn to non-load side

7th digit Option Specification

- High mechanical precision

Linear Servomotors

SGL □ □ - 30 A 050 C P □

Series 1st digit 2nd digit 3rd digit on

Series Σ -7 Series Servomotors 2nd digit Moving Coil/Magnetic Way

1st digit Servomotor Type

Code	Specification
G	Coreless models
F	Models with F-type iron core
T	Models with T-type iron core

Code	Specification
W	Moving Coil
W2	
M	Magnetic Way
M2	

3rd digit on

The specifications for the 3rd digit on depend on the Servomotor type.

1.7 Combinations of SERVOPACKs and Servomotors

1.7.1 Combinations of Rotary Servomotors and SERVOPACKs

Rotary Servomotor Model		Capacity	SERVOPACK Model SGD7S-
SGM7M (Low Inertia, Ultra-small Capacity), 3000 min ⁻¹	SGM7M-A1A	11 W	R90A or R90F
	SGM7M-A2A	22 W	
	SGM7M-A3A	33 W	1R6A or 2R1F
SGM7J (Medium Inertia, Small Capacity), 3,000 min ⁻¹	SGM7J-A5A	50 W	R70A or R70F
	SGM7J-01A	100 W	R90A or R90F
	SGM7J-C2A	150 W	1R6A or 2R1F
	SGM7J-02A	200 W	
	SGM7J-04A	400 W	2R8A or 2R8F
	SGM7J-06A	600 W	5R5A
	SGM7J-08A	750 W	
SGM7A (Low Inertia, Small Capacity), 3,000 min ⁻¹	SGM7A-A5A	50 W	R70A or R70F
	SGM7A-01A	100 W	R90A or R90F
	SGM7A-C2A	150 W	1R6A or 2R1F
	SGM7A-02A	200 W	
	SGM7A-04A	400 W	2R8A or 2R8F
	SGM7A-06A	600 W	5R5A
	SGM7A-08A	750 W	
	SGM7A-10A	1.0 kW	120A
	SGM7A-15A	1.5 kW	180A
	SGM7A-20A	2.0 kW	
	SGM7A-25A	2.5 kW	200A
	SGM7A-30A	3.0 kW	
	SGM7A-40A	4.0 kW	330A
	SGM7A-50A	5.0 kW	
SGM7A-70A	7.0 kW	550A	
SGM7P (Medium Inertia, Flat), 3,000 min ⁻¹	SGM7P-01A	100 W	R90A or R90F
	SGM7P-02A	200 W	2R8A or 2R1F
	SGM7P-04A	400 W	2R8A or 2R8F
	SGM7P-08A	750 W	5R5A
	SGM7P-15A	1.5 kW	120A
SGM7G (Medium Inertia, Medium Capacity), 1,500 min ⁻¹	SGM7G-03A	300 W	3R8A
	SGM7G-05A	450 W	
	SGM7G-09A	850 W	7R6A
	SGM7G-13A	1.3 kW	120A
	SGM7G-20A	1.8 kW	180A
	SGM7G-30A	2.9 kW* ¹	330A
	SGM7G-44A	4.4 kW	
	SGM7G-55A	5.5 kW	470A
	SGM7G-75A	7.5 kW	550A
	SGM7G-1AA	11 kW	590A
SGM7G-1EA	15 kW	780A	
SGMMV* ² (Low Inertia, Ultra-small Capacity), 3,000 min ⁻¹	SGMMV-A1A	10 W	R90A or R90F
	SGMMV-A2A	20 W	
	SGMMV-A3A	30 W	1R6A or 2R1F

*1. 2.4 kW when using the Servomotor with a SGD7S-200A SERVOPACK.

*2. The SGM7M Servomotor is an older model. When purchasing a new Servomotor, we recommend selecting a SGM7M Servomotor.

1.7.2 Combinations of Direct Drive Servomotors and SERVOPACKs

Direct Drive Servomotor Model		Rated Torque [N·m]	Instantaneous Maximum Torque [N·m]	SERVOPACK Model
				SGD7S-
SGM7E (Small Capacity, Coreless, Inner Rotor)	SGM7E-02B	2	6	2R8A or 2R1F
	SGM7E-05B	5	15	
	SGM7E-07B	7	21	
	SGM7E-04C	4	12	2R8A or 2R8F
	SGM7E-10C	10	30	
	SGM7E-14C	14	42	
	SGM7E-08D	8	24	
	SGM7E-17D	17	51	
	SGM7E-25D	25	75	5R5A
	SGM7E-16E	16	48	
	SGM7E-35E	35	105	
SGM7F (Small Capacity, With Core, Inner Rotor)	SGM7F-02A	2	6	2R8A or 2R1F
	SGM7F-05A	5	15	
	SGM7F-07A	7	21	
	SGM7F-04B	4	12	2R8A or 2R8F
	SGM7F-10B	10	30	
	SGM7F-14B	14	42	5R5A
	SGM7F-08C	8	24	2R8A or 2R8F
	SGM7F-17C	17	51	5R5A
	SGM7F-25C	25	75	7R6A
	SGM7F-16D	16	48	5R5A
	SGM7F-35D	35	105	7R6A* or 120A
	SGM7F (Medium Capacity, With Core, Inner Rotor)	SGM7F-45M	45	135
SGM7F-80M		80	240	120A
SGM7F-80N		80	240	
SGM7F-1AM		110	330	180A
SGM7F-1EN		150	450	200A
SGM7F-2ZN		200	600	
SGM7F (Small Capacity, With Core, Inner Rotor)	SGM7F-04B	4	12	2R8A or 2R8F
	SGM7F-10B	10	30	
	SGM7F-14B	14	42	5R5A
	SGM7F-08C	8	24	2R8A or 2R8F
	SGM7F-17C	17	51	5R5A
	SGM7F-25C	25	75	7R6A
	SGM7F-16D	16	48	5R5A
	SGM7F-35D	35	105	7R6A* or 120A

Continued on next page.

1.7 Combinations of SERVOPACKs and Servomotors

1.7.2 Combinations of Direct Drive Servomotors and SERVOPACKs

Continued from previous page.

Direct Drive Servomotor Model		Rated Torque [N·m]	Instantaneous Maximum Torque [N·m]	SERVOPACK Model
				SGD7S-
SGMCS (Small Capacity, Coreless, Inner Rotor)	SGMCS-02B	2	6	2R8A or 2R1F
	SGMCS-05B	5	15	
	SGMCS-07B	7	21	
	SGMCS-04C	4	12	2R8A or 2R8F
	SGMCS-10C	10	30	
	SGMCS-14C	14	42	
	SGMCS-08D	8	24	
	SGMCS-17D	17	51	
	SGMCS-25D	25	75	
	SGMCS-16E	16	48	5R5A
	SGMCS-35E	35	105	
SGMCS (Medium Capacity, With Core, Inner Rotor)	SGMCS-45M	45	135	7R6A
	SGMCS-80M	80	240	120A
	SGMCS-80N	80	240	
	SGMCS-1AM	110	330	180A
	SGMCS-1EN	150	450	200A
	SGMCS-2ZN	200	600	

* Use derated values for this combination. Refer to the following catalog for information on derating values.
 AC Servo Drives Σ-7 Series (Catalog No.: KAEP S800001 23)

1.7.3 Combinations of Linear Servomotors and SERVOPACKs

Linear Servomotor Model		Rated Force [N]	Instantaneous Maximum Force [N]	SERVOPACK Model
				SGD7S-
SGLG (Coreless), Used with Standard- Force Magnetic Way	SGLGW-30A050C	12.5	40	R70A or R70F
	SGLGW-30A080C	25	80	R90A or R90F
	SGLGW-40A140C	47	140	
	SGLGW-40A253C	93	280	1R6A or 2R1F
	SGLGW-40A365C	140	420	2R8A or 2R8F
	SGLGW-60A140C	70	220	1R6A or 2R1F
	SGLGW-60A253C	140	440	2R8A or 2R8F
	SGLGW-60A365C	210	660	5R5A
	SGLGW-90A200C	325	1300	120A
	SGLGW-90A370C	550	2200	180A
SGLGW-90A535C	750	3000	200A	
SGLG (Coreless), Used with High-Force Magnetic Way	SGLGW-40A140C	57	230	1R6A or 2R1F
	SGLGW-40A253C	114	460	2R8A or 2R8F
	SGLGW-40A365C	171	690	3R8A
	SGLGW-60A140C	85	360	1R6A or 2R1F
	SGLGW-60A253C	170	720	3R8A
	SGLGW-60A365C	255	1080	7R6A
SGLF (With F-type Iron Cores)	SGLFW-20A090A	25	86	1R6A or 2R1F
	SGLFW-20A120A	40	125	
	SGLFW-35A120A	80	220	
	SGLFW-35A230A	160	440	3R8A
	SGLFW-50A200B	280	600	5R5A
	SGLFW-50A380B	560	1200	120A
	SGLFW-1ZA200B			
	SGLFW-1ZA380B	1120	2400	200A
	SGLFW2-30A070A	45	135	1R6A or 2R1F
	SGLFW2-30A120A	90	270	
	SGLFW2-30A230A*	180	540	3R8A
		170	500	2R8A or 2R8F
	SGLFW2-45A200A	280	840	5R5A
	SGLFW2-45A380A*	560	1680	180A
			1500	
	SGLFW2-90A200A□1	560	1680	120A
	SGLFW2-90A200A□L	896	1680	
	SGLFW2-90A380A	1120	3360	200A
	SGLFW2-90A560A	1680	5040	330A
SGLFW2-1DA380A	1680	5040	200A	
SGLFW2-1DA560A	2520	7560	330A	

Continued on next page.

1.7 Combinations of SERVOPACKs and Servomotors

1.7.3 Combinations of Linear Servomotors and SERVOPACKs

Continued from previous page.

Linear Servomotor Model		Rated Force [N]	Instantaneous Maximum Force [N]	SERVOPACK Model
				SGD7S-
SGLT (With T-type Iron Cores)	SGLTW-20A170A	130	380	3R8A
	SGLTW-20A320A	250	760	7R6A
	SGLTW-20A460A	380	1140	120A
	SGLTW-35A170A	220	660	5R5A
	SGLTW-35A170H	300	600	
	SGLTW-35A320A	440	1320	120A
	SGLTW-35A320H	600	1200	
	SGLTW-35A460A	670	2000	180A
	SGLTW-40A400B	670	2600	
	SGLTW-40A600B	1000	4000	330A
	SGLTW-50A170H	450	900	5R5A
	SGLTW-50A320H	900	1800	120A
	SGLTW-80A400B	1300	5000	330A
	SGLTW-80A600B	2000	7500	550A

* The force depends on the SERVOPACK that is used with the Servomotor.

1.8 Functions

This section lists the functions provided by SERVOPACKs. Refer to the reference pages for details on the functions.

• Functions Related to the Machine

Function	Reference
Power Supply Type Settings for the Main Circuit and Control Circuit	page 5-12
Automatic Detection of Connected Motor	page 5-14
Motor Direction Setting	page 5-15
Linear Encoder Pitch Setting	page 5-16
Writing Linear Servomotor Parameters	page 5-17
Selecting the Phase Sequence for a Linear Servomotor	page 5-21
Polarity Sensor Setting	page 5-23
Polarity Detection	page 5-24
Overtravel Function and Settings	page 5-27
Holding Brake	page 5-31
Motor Stopping Methods for Servo OFF and Alarms	page 5-35
Resetting the Absolute Encoder	page 5-48
Setting the Origin of the Absolute Encoder	page 5-51
Setting the Regenerative Resistor Capacity	page 5-54
Operation for Momentary Power Interruptions	page 6-11
SEMI F47 Function	page 6-12
Setting the Motor Maximum Speed	page 6-14
Multiturn Limit Setting	page 6-25
Adjustment of Motor Current Detection Signal Offset	page 6-36
Software Limits and Settings	page 12-2
Overheat Protection	page 6-40
Speed Ripple Compensation	page 8-58
Current Control Mode Selection	page 8-70
Current Gain Level Setting	page 8-70
Speed Detection Method Selection	page 8-71
Fully-Closed Loop Control	page 10-1
Safety Functions	page 11-1

• Functions Related to the Host Controller

Function	Reference
Electronic Gear Settings	page 5-41
Servo Alarm (ALM) Signal	page 6-3
Warning (/WARN) Signal	page 6-7
Servo Ready (/S-RDY) Signal	page 6-8
Positioning Completion Output (/INPOSITION) Signal	page 6-9
Encoder Divided Pulse Output	page 6-15
Selecting Torque Limits	page 6-22
Vibration Detection Level Initialization	page 6-32
Alarm Reset	page 15-49
Replacing the Battery	page 15-3
Setting the Position Deviation Overflow Alarm Level	page 8-7

• **Functions to Achieve Optimum Motions**

Function	Reference
Tuning-less Function	page 8-11
Autotuning without a Host Reference	page 8-23
Autotuning with a Host Reference	page 8-34
Custom Tuning	page 8-41
Anti-Resonance Control Adjustment	page 8-49
Vibration Suppression	page 8-54
Gain Selection	page 8-64
Friction Compensation	page 8-67
Gravity Compensation	page 8-69
Backlash Compensation	page 8-71
Model Following Control	page 8-81
Compatible Adjustment Functions	page 8-84
Mechanical Analysis	page 8-88
Easy FFT	page 8-89

• **Functions for Trial Operation during Setup**

Function	Reference
Software Reset	page 6-30
Trial Operation for the Servomotor without a Load	page 7-6
Program Jog Operation	page 7-13
Origin Search	page 7-19
Test without a Motor	page 7-21
Monitoring Machine Operation Status and Signal Waveforms	page 9-7

• **Functions for Inspection and Maintenance**

Function	Reference
Write Prohibition Setting for Parameters	page 5-6
Initializing Parameter Settings	page 5-10
Automatic Detection of Connected Motor	page 5-14
Monitoring Product Information	page 9-2
Monitoring Product Life	page 9-2
Alarm History Display	page 15-51
Alarm Tracing	page 9-17

• **Operation with Digital I/O**

Function	Reference
Homing	page 13-4
Positioning with a Program Table	page 13-9
Registration	page 13-10
Constant Speed Operations with a Jog Speed Table	page 13-44
ZONE Outputs	page 13-52

- Operations with Serial Command Communications

Function	Reference
Homing	page 14-12
Positioning, Jog Operation, and Registration with Serial Commands	page 14-15
Positioning with a Program Table	page 14-24
Editing a Jog Speed Table	page 14-29
Editing a ZONE Table	page 14-29
Editing Parameters, Monitoring, and Utility Functions	page 14-30

Selecting a SERVOPACK

2

This chapter provides information required to select SERVOPACKs, such as specifications, block diagrams, dimensional drawings, and connection examples.

2.1 Ratings and Specifications 2-2

- 2.1.1 Ratings 2-2
- 2.1.2 Power Loss in the INDEXER Module 2-5
- 2.1.3 SERVOPACK Overload Protection
Characteristics 2-6
- 2.1.4 Specifications 2-7

2.2 Block Diagrams 2-11

- 2.2.1 SGD7S-R70A, -R90A, and -1R6A 2-11
- 2.2.2 SGD7S-2R8A 2-11
- 2.2.3 SGD7S-3R8A, -5R5A, and -7R6A 2-12
- 2.2.4 SGD7S-120A 2-13
- 2.2.5 SGD7S-180A and -200A 2-15
- 2.2.6 SGD7S-330A 2-16
- 2.2.7 SGD7S-470A and -550A 2-17
- 2.2.8 SGD7S-590A and -780A 2-18
- 2.2.9 SGD7S-R70F, -R90F, and -2R1F 2-19
- 2.2.10 SGD7S-2R8F 2-19

2.3 External Dimensions 2-20

- 2.3.1 Front Cover Dimensions and Connector
Specifications 2-20
- 2.3.2 SERVOPACK External Dimensions 2-20
- 2.3.3 INDEXER Module Dimensions and Connector
Specifications 2-26

2.4 Examples of Standard Connections between SERVOPACKs and Peripheral Devices . . 2-27

2.1 Ratings and Specifications

This section gives the ratings and specifications of SERVOPACKs.

2.1.1 Ratings

Three-Phase, 200 VAC

Model SGD7S-		R70A	R90A	1R6A	2R8A	3R8A	5R5A	7R6A	120A	180A	200A	330A	
Maximum Applicable Motor Capacity [kW]		0.05	0.1	0.2	0.4	0.5	0.75	1.0	1.5	2.0	3.0	5.0	
Continuous Output Current [Arms]		0.66	0.91	1.6	2.8	3.8	5.5	7.6	11.6	18.5	19.6	32.9	
Instantaneous Maximum Output Current [Arms]		2.1	3.2	5.9	9.3	11	16.9	17	28	42	56	84	
Main Circuit	Power Supply	200 VAC to 240 VAC, 50 Hz/60 Hz											
	Permitted Voltage Fluctuation	-15% to +10%											
	Input Current [Arms]*	0.4	0.8	1.3	2.5	3.0	4.1	5.7	7.3	10	15	25	
Control	Power Supply	200 VAC to 240 VAC, 50 Hz/60 Hz											
	Permitted Voltage Fluctuation	-15% to +10%											
	Input Current [Arms]*	0.2	0.2	0.2	0.2	0.2	0.2	0.2	0.2	0.2	0.25	0.25	0.3
Power Supply Capacity [kVA]*		0.2	0.3	0.5	1.0	1.3	1.6	2.3	3.2	4.0	5.9	7.5	
Power Loss*	Main Circuit Power Loss [W]	5.0	7.0	11.9	22.5	28.5	38.9	49.2	72.6	104.2	114.2	226.6	
	Control Circuit Power Loss [W]	12	12	12	12	14	14	14	15	16	16	19	
	Built-in Regenerative Resistor Power Loss [W]	–	–	–	–	8	8	8	12	12	12	36	
	Total Power Loss [W]	17.0	19.0	23.9	34.5	50.5	60.9	71.2	97.6	136.2	146.2	281.6	
Regenerative Resistor	Built-In Regenerative Resistor	Resistance [Ω]	–	–	–	–	40	40	40	20	12	12	8
		Capacity [W]	–	–	–	–	40	40	40	60	60	60	180
	Minimum Allowable External Resistance [Ω]	40	40	40	40	40	40	40	40	20	12	12	8
Overvoltage Category		III											

* This is the net value at the rated load.

Model SGD7S-		470A	550A	590A	780A
Maximum Applicable Motor Capacity [kW]		6.0	7.5	11	15
Continuous Output Current [Arms]		46.9	54.7	58.6	78.0
Instantaneous Maximum Output Current [Arms]		110	130	140	170
Main Circuit	Power Supply	200 VAC to 240 VAC, 50 Hz/60 Hz			
	Permitted Voltage Fluctuation	-15% to +10%			
	Input Current [Arms] ^{*1}	29	37	54	73
Control	Power Supply	200 VAC to 240 VAC, 50 Hz/60 Hz			
	Permitted Voltage Fluctuation	-15% to +10%			
	Input Current [Arms] ^{*1}	0.3	0.3	0.4	0.4
Power Supply Capacity [kVA] ^{*1}		10.7	14.6	21.7	29.6
Power Loss ^{*1}	Main Circuit Power Loss [W]	271.7	326.9	365.3	501.4
	Control Circuit Power Loss [W]	21	21	28	28
	External Regenerative Resistor Unit Power Loss [W]	180 ^{*2}	350 ^{*3}	350 ^{*3}	350 ^{*3}
	Total Power Loss [W]	292.7	347.9	393.3	529.4
External Regenerative Resistor Unit	Resistance [Ω]	6.25 ^{*2}	3.13 ^{*3}	3.13 ^{*3}	3.13 ^{*3}
	Capacity [W]	880 ^{*2}	1760 ^{*3}	1760 ^{*3}	1760 ^{*3}
	Minimum Allowable External Resistance [Ω]	5.8	2.9	2.9	2.9
Overvoltage Category		III			

*1. This is the net value at the rated load.

*2. This value is for the optional JUSP-RA04-E Regenerative Resistor Unit.

*3. This value is for the optional JUSP-RA05-E Regenerative Resistor Unit.

Single-Phase, 200 VAC

Model SGD7S-		R70A	R90A	1R6A	2R8A	5R5A	120A
Maximum Applicable Motor Capacity [kW]		0.05	0.1	0.2	0.4	0.75	1.5
Continuous Output Current [Arms]		0.66	0.91	1.6	2.8	5.5	11.6
Instantaneous Maximum Output Current [Arms]		2.1	3.2	5.9	9.3	16.9	28
Main Circuit	Power Supply	200 VAC to 240 VAC, 50 Hz/60 Hz					
	Permitted Voltage Fluctuation	-15% to +10%					
	Input Current [Arms]*	0.8	1.6	2.4	5.0	8.7	16
Control	Power Supply	200 VAC to 240 VAC, 50 Hz/60 Hz					
	Permitted Voltage Fluctuation	-15% to +10%					
	Input Current [Arms]*	0.2	0.2	0.2	0.2	0.2	0.25
Control Power Supply		200 VAC to 240 VAC, -15% to +10%, 50 Hz/60 Hz					
Power Supply Capacity [kVA]*		0.2	0.3	0.6	1.2	1.9	4.0
Power Loss*	Main Circuit Power Loss [W]	5.0	7.1	12.1	23.7	39.2	71.8
	Control Circuit Power Loss [W]	12	12	12	12	14	16
	Built-in Regenerative Resistor Power Loss [W]	–	–	–	–	8	12
	Total Power Loss [W]	17.0	19.1	24.1	35.7	61.2	103.8
Regenerative Resistor	Built-In Regenerative Resistor	Resistance [Ω]	–	–	–	40	12
		Capacity [W]	–	–	–	40	60
	Minimum Allowable External Resistance [Ω]		40	40	40	40	40
Overvoltage Category		III					

* This is the net value at the rated load.

2.1 Ratings and Specifications

2.1.1 Ratings

270 VDC

Model SGD7S-		R70A	R90A	1R6A	2R8A	3R8A	5R5A	7R6A	120A
Maximum Applicable Motor Capacity [kW]		0.05	0.1	0.2	0.4	0.5	0.75	1.0	1.5
Continuous Output Current [Arms]		0.66	0.91	1.6	2.8	3.8	5.5	7.6	11.6
Instantaneous Maximum Output Current [Arms]		2.1	3.2	5.9	9.3	11.0	16.9	17.0	28.0
Main Circuit	Power Supply	270 VDC to 324 VDC							
	Permitted Voltage Fluctuation	-15% to +10%							
	Input Current [Arms] ^{*1}	0.5	1.0	1.5	3.0	3.8	4.9	6.9	11
Control	Power Supply	270 VDC to 324 VDC							
	Permitted Voltage Fluctuation	-15% to +10%							
	Input Current [Arms] ^{*1}	0.2	0.2	0.2	0.2	0.2	0.2	0.2	0.2 ^{*2}
Power Supply Capacity [kVA] ^{*1}		0.2	0.3	0.6	1	1.4	1.6	2.3	3.2
Power Loss ^{*1}	Main Circuit Power Loss [W]	4.4	5.9	9.8	17.5	23.0	30.7	38.7	55.8
	Control Circuit Power Loss [W]	12	12	12	12	14	14	14	15
	Total Power Loss [W]	16.4	17.9	21.8	29.5	37.0	44.7	52.7	70.8
Overvoltage Category		III							

*1. This is the net value at the rated load.

*2. This is 0.25 Arms for the SGD7S-120AE0A008.

Model SGD7S-		180A	200A	330A	470A	550A	590A	780A
Maximum Applicable Motor Capacity [kW]		2.0	3.0	5.0	6.0	7.5	11.0	15.0
Continuous Output Current [Arms]		18.5	19.6	32.9	46.9	54.7	58.6	78.0
Instantaneous Maximum Output Current [Arms]		42.0	56.0	84.0	110	130	140	170
Main Circuit	Power Supply	270 VDC to 324 VDC						
	Permitted Voltage Fluctuation	-15% to +10%						
	Input Current [Arms]*	14	20	34	36	48	68	92
Control	Power Supply	270 VDC to 324 VDC						
	Permitted Voltage Fluctuation	-15% to +10%						
	Input Current [Arms]*	0.25	0.25	0.3	0.3	0.3	0.4	0.4
Power Supply Capacity [kVA]*		4.0	5.9	7.5	10.7	14.6	21.7	29.6
Power Loss*	Main Circuit Power Loss [W]	82.7	83.5	146.2	211.6	255.3	243.6	343.4
	Control Circuit Power Loss [W]	16	16	19	21	21	28	28
	Total Power Loss [W]	98.7	99.5	165.2	232.6	276.3	271.6	371.4
Overvoltage Category		III						

* This is the net value at the rated load.

Single-Phase, 100 VAC

Model SGD7S-		R70F	R90F	2R1F	2R8F
Maximum Applicable Motor Capacity [kW]		0.05	0.1	0.2	0.4
Continuous Output Current [Arms]		0.66	0.91	2.1	2.8
Instantaneous Maximum Output Current [Arms]		2.1	3.2	6.5	9.3
Main Circuit	Power Supply	100 VAC to 120 VAC, 50 Hz/60 Hz			
	Permitted Voltage Fluctuation	-15% to +10%			
	Input Current [Arms]*	1.5	2.5	5	10
Control	Power Supply	100 VAC to 120 VAC, 50 Hz/60 Hz			
	Permitted Voltage Fluctuation	-15% to +10%			
	Input Current [Arms]*	0.38	0.38	0.38	0.38
Power Supply Capacity [kVA]*		0.2	0.3	0.6	1.4
Power Loss*	Main Circuit Power Loss [W]	5.3	7.8	14.2	26.2
	Control Circuit Power Loss [W]	12	12	12	12
	Total Power Loss [W]	17.3	19.8	26.2	38.2
Regenerative Resistor	Minimum Allowable Resistance [Ω]	40	40	40	40
Overvoltage Category		III			

* This is the net value at the rated load.

2.1.2 Power Loss in the INDEXER Module

Power is supplied to the INDEXER Module from the control power supply of the SERVOPACK. The power loss is given in the following table.

Item	Specifications
Min. operating voltage	5.05 V
Max. operating voltage	5.25 V
Max. operating current	500 mA
Max. power loss	2.6 W

2.1.3 SERVOPACK Overload Protection Characteristics

The overload detection level is set for hot start conditions with a SERVOPACK surrounding air temperature of 55°C.

An overload alarm (A.710 or A.720) will occur if overload operation that exceeds the overload protection characteristics shown in the following diagram (i.e., operation on the right side of the applicable line) is performed.

The actual overload detection level will be the detection level of the connected SERVOPACK or Servomotor that has the lower overload protection characteristics.

In most cases, that will be the overload protection characteristics of the Servomotor.

- SGD7S-R70A, -R90A, -1R6A, -2R8A, -R70F, -R90F, -2R1F, and -2R8F

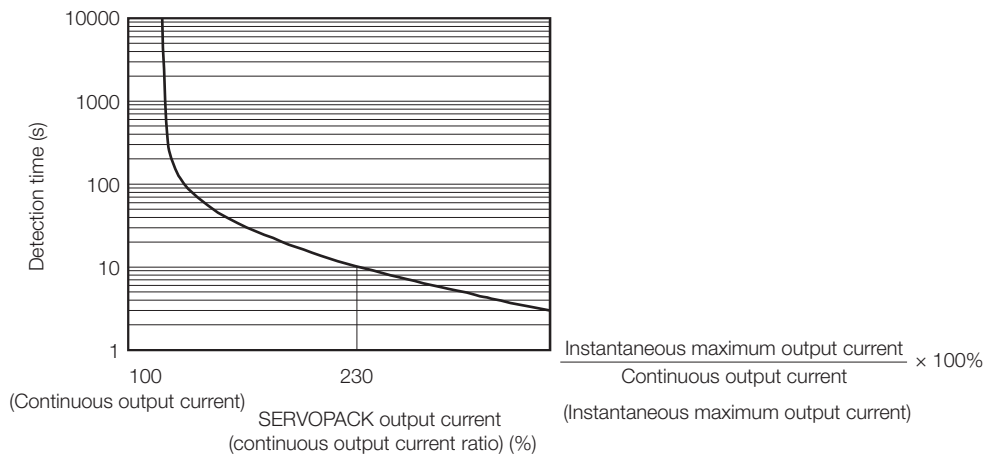

Note: The above overload protection characteristics do not mean that you can perform continuous duty operation with an output of 100% or higher.

For a Yaskawa-specified combination of SERVOPACK and Servomotor, maintain the effective torque within the continuous duty zone of the torque-motor speed characteristic of the Servomotor.

- SGD7S-3R8A, -5R5A, -7R6A, -120A, -180A, -200A, -330A, -470A, -550A, -590A, and -780A

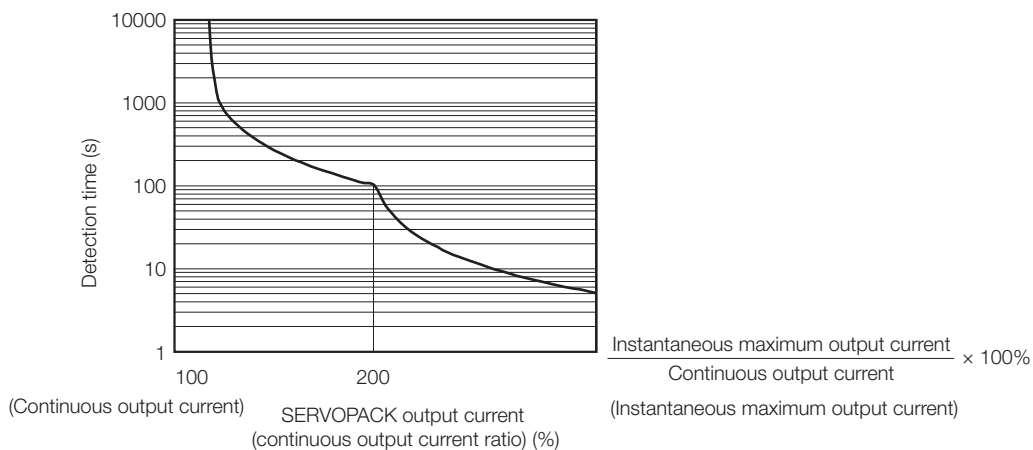

Note: The above overload protection characteristics do not mean that you can perform continuous duty operation with an output of 100% or higher.

For a Yaskawa-specified combination of SERVOPACK and Servomotor, maintain the effective torque within the continuous duty zone of the torque-motor speed characteristic of the Servomotor.

2.1.4 Specifications

The specifications when the INDEXER Module is combined with a Command Option Attachable-type SERVOPACK are given in the following table.

Item		Specification	
Control Method		IGBT-based PWM control, sine wave current drive	
Feedback	With Rotary Servomotor	Serial encoder: 17 bits (absolute encoder) 20 bits or 24 bits (incremental encoder/absolute encoder) 22 bits (absolute encoder)	
	With Linear Servomotor	<ul style="list-style-type: none"> Absolute linear encoder (The signal resolution depends on the absolute linear encoder.) Incremental linear encoder (The signal resolution depends on the incremental linear encoder or Serial Converter Unit.) 	
Environmental Conditions	Surrounding Air Temperature	0°C to 55°C	
	Storage Temperature	-20°C to 85°C	
	Surrounding Air Humidity	90% relative humidity max. (with no freezing or condensation)	
	Storage Humidity	90% relative humidity max. (with no freezing or condensation)	
	Vibration Resistance	4.9 m/s ²	
	Shock Resistance	19.6 m/s ²	
	Degree of Protection	Degree	SERVOPACK Model: SGD7S-
		IP20	R70A, R90A, 1R6A, 2R8A, 3R8A, 5R5A, 7R6A, 120A, R70F, R90F, 2R1F, 2R8F
		IP10	120A00A008, 180A, 200A, 330A, 470A, 550A, 590A, 780A
	Pollution Degree	2 <ul style="list-style-type: none"> Must be no corrosive or flammable gases. Must be no exposure to water, oil, or chemicals. Must be no dust, salts, or iron dust. 	
Altitude	1,000 m or less.		
Others	Do not use the SERVOPACK in the following locations: Locations subject to static electricity, noise, strong electromagnetic/magnetic fields, or radioactivity		
Compliant Standards		Refer to the following section for details.  <i>Compliance with UL Standards, EU Directives, UK Regulations, and Other Safety Standards on page xxvi</i>	
Mounting	Mounting	SERVOPACK Model: SGD7S-	
	Base-mounted	All Models	
	Rack-mounted	R70A, R90A, 1R6A, 2R8A, 3R8A, 5R5A, 7R6A, 120A, 180A, 200A, 330A, R70F, R90F, 2R1F, 2R8F	
	Duct-ventilated	470A, 550A, 590A, 780A	
Performance	Speed Control Range	1:5000 (At the rated torque, the lower limit of the speed control range must not cause the Servomotor to stop.)	
	Coefficient of Speed Fluctuation* ¹	±0.01% of rated speed max. (for a load fluctuation of 0% to 100%)	
		0% of rated speed max. (for a voltage fluctuation of ±10%)	
		±0.1% of rated speed max. (for a temperature fluctuation of 25°C ±25°C)	
Torque Control Precision (Repeatability)	±1%		
Soft Start Time Setting	0 s to 10 s (Can be set separately for acceleration and deceleration.)		

Continued on next page.

2.1 Ratings and Specifications

2.1.4 Specifications

Continued from previous page.

Item		Specification		
I/O Signals	Encoder Divided Pulse Output	Phase A, phase B, phase C: Line-driver output Number of divided output pulses: Any setting is allowed.		
	Overheat Protection Input	Number of input points: 1 Input voltage range: 0 V to +5 V		
	Sequence Input Signals	SERVOPACK	Allowable voltage range: 24 VDC \pm 20% Number of input points: 6 (Input method: Sink inputs or source inputs)	
			Input signals: <ul style="list-style-type: none"> • /ALM-RST (Alarm Reset) signal • P-OT (Forward Drive Prohibit) signal • N-OT (Reverse Drive Prohibit) signal • /DEC (Homing Deceleration) switch • /RGRT (Registration Input) signal • /S-ON (Servo ON) signal Positive or negative logic can be changed in the parameters.	
		INDEXER Module	Allowable voltage range: 24 VDC \pm 10% Number of input points: 11 (Input method: Sink inputs or source inputs)	
			Input signal: MODE 0/1 (Mode Switch Input) signal	
		Mode 0	Mode 1	
		<ul style="list-style-type: none"> • /START-STOP (Program Table Operation Start-Stop Input) signal • /PGMRES (Program Table Operation Reset Input) signal • /SEL0 (Program Step Selection Input 0) signal • /SEL1 (Program Step Selection Input 1) signal • /SEL2 (Program Step Selection Input 2) signal • /SEL3 (Program Step Selection Input 3) signal • /SEL4 (Program Step Selection Input 4) signal • /SEL5 (Program Step Selection Input 5) signal • /SEL6 (Program Step Selection Input 6) signal • /SEL7 (Program Step Selection Input 7) signal 	<ul style="list-style-type: none"> • /HOME (Homing Input) signal • /JOGP (Forward Jog Input) signal • /JOGN (Reverse Jog Input) signal • /JOG0 (Jog Speed Table Selection Input 0) signal • /JOG1 (Jog Speed Table Selection Input 1) signal • /JOG2 (Jog Speed Table Selection Input 2) signal • /JOG3 (Jog Speed Table Selection Input 3) signal 	

Continued on next page.

Continued from previous page.

Item			Specification	
I/O Signals	Sequence Output Signals	SERVOPACK	Fixed Outputs Allowable voltage range: 5 VDC to 30 VDC Number of output points: 1 (Output method: A photocoupler output (isolated) is used.) Output signal: ALM (Servo Alarm Output) signal	
			Output Signals for Which Allocations Can Be Changed Allowable voltage range: 5 VDC to 30 VDC Number of output points: 3 (A photocoupler output (isolated) is used.) Output signals: • /WARN (Warning Output) signal • /BK (Brake Output) signal • /S-RDY (Servo Ready Output) signal • /ALO1, /ALO2, and /ALO3 (Alarm Code Output) signals Signal allocations and positive or negative logic can be changed in the parameters.	
		INDEXER Module	Fixed Outputs	Allowable voltage range: 5 VDC to 30 VDC Number of output points: 9 (Output method: A photocoupler output (isolated) is used.) Output signals: • /INPOSITION (Positioning Completion Output) signal • /POUT0 (Programmable Output 0) signal • /POUT1 (Programmable Output 1) signal • /POUT2 (Programmable Output 2) signal • /POUT3 (Programmable Output 3) signal • /POUT4 (Programmable Output 4) signal • /POUT5 (Programmable Output 5) signal • /POUT6 (Programmable Output 6) signal • /POUT7 (Programmable Output 7) signal
Communications	Digital Operator Communications (CN3)	Interfaces	Digital Operator (JUSP-OP05A-1-E)	
		1:N Communications	Up to N = 15 stations possible for RS-422A port	
		Axis Address Setting	Set with parameters.	
	USB Communications (CN7)	Interface	Personal computer (with SigmaWin+)	
Communications Standard		Conforms to USB2.0 standard (12 Mbps).		
Displays/Indicators	SERVOPACK		CHARGE and PWR indicators, and one-digit seven-segment display	
	INDEXER Module		Refer to the following section for detailed information.  1.5.2 Indicators on page 1-11	

Continued on next page.

2.1 Ratings and Specifications

2.1.4 Specifications

Continued from previous page.

Item		Specification
Operating Methods	Program Table Method	<ul style="list-style-type: none"> Program table positioning in which steps are executed sequentially by commands given through contact input or serial communications Positioning in which station numbers are specified by commands given through contact input or serial communications
	Max. Number of Steps	256
	Max. Number of Tables	256
	Max. Number of Stations	256
	Serial Communications Method	Serial command by 1-channel ASCII code Communications specifications: RS-422/485 (50 m max.) Connection topology: Multi-drop connection (16 axes max.) Baud rate: 9600, 19200, 38400 bps
Other Functions	Registration (positioning by external signals), homing	
Analog Monitor (CN5)		Number of points: 2 Output voltage range: ±10 VDC (effective linearity range: ±8 V) Resolution: 16 bits Accuracy: ±20 mV (Typ) Maximum output current: ±10 mA Settling time (±1%): 1.2 ms (Typ)
Dynamic Brake (DB)		Activated when a servo alarm or overtravel (OT) occurs, or when the power supply to the main circuit or servo is OFF.
Regenerative Processing		Built-in (An external resistor must be connected to the SGD7S-470A to -780A.) Refer to the following manual for details.  Σ-7-Series Peripheral Device Selection Manual (Manual No.: SIEP S800001 32)
Overtravel (OT) Prevention		Stopping with dynamic brake, deceleration to a stop, or coasting to a stop for the P-OT (Forward Drive Prohibit) or N-OT (Reverse Drive Prohibit) signal
Protective Functions		Overcurrent, overvoltage, low voltage, overload, regeneration error, etc.
Utility Functions		Gain adjustment, alarm history, jog operation, origin search, etc.
Safety Functions	Inputs	/HWBB1 and /HWBB2: Base block signals for Power Modules
	Output	EDM1: Monitors the status of built-in safety circuit (fixed output).
	Compliant Standards*2	ISO13849-1 PLe (Category 3), IEC61508 SIL3
Applicable Option Modules		Fully-Closed Module Note: You cannot use a Safety Module if you are using an INDEXER Module.

*1. The coefficient of speed fluctuation for load fluctuation is defined as follows:

$$\text{Coefficient of speed fluctuation} = \frac{\text{No-load motor speed} - \text{Total-load motor speed}}{\text{Rated motor speed}} \times 100\%$$

*2. Always perform risk assessment for the system and confirm that the safety requirements are met.

2.2 Block Diagrams

2.2.1 SGD7S-R70A, -R90A, and -1R6A

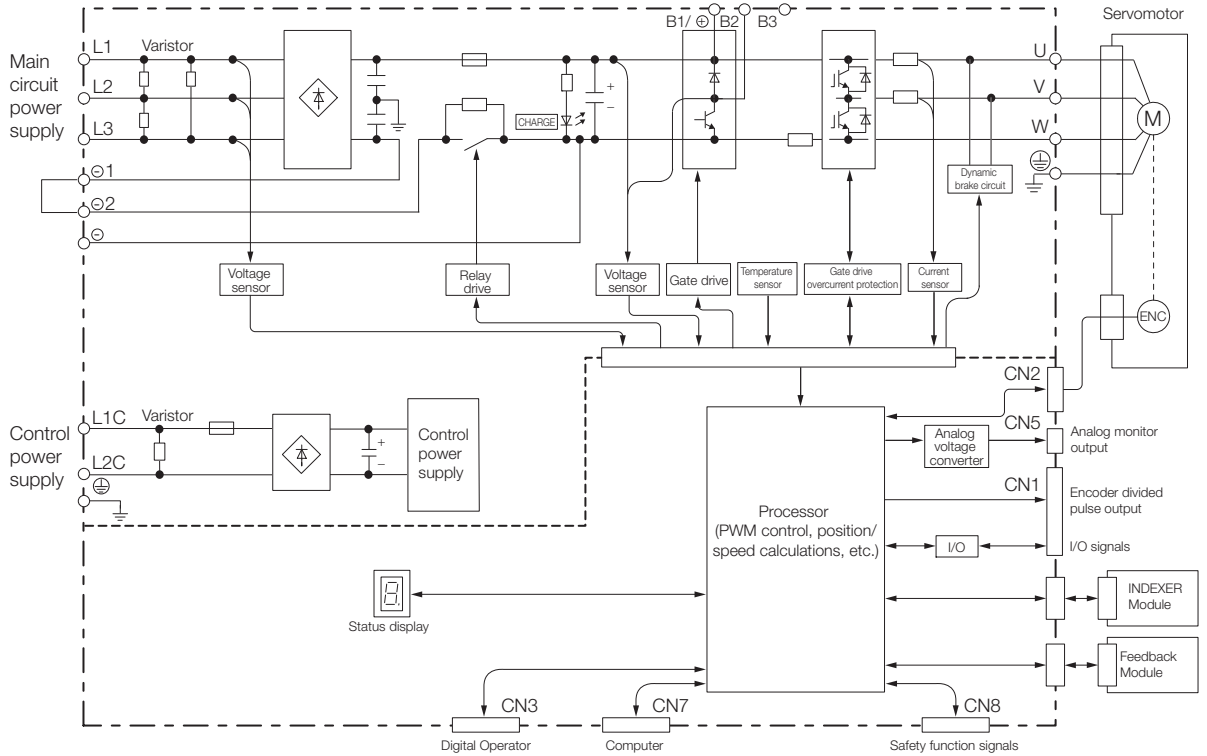

Selecting a SERVOPACK

2

2.2.2 SGD7S-2R8A

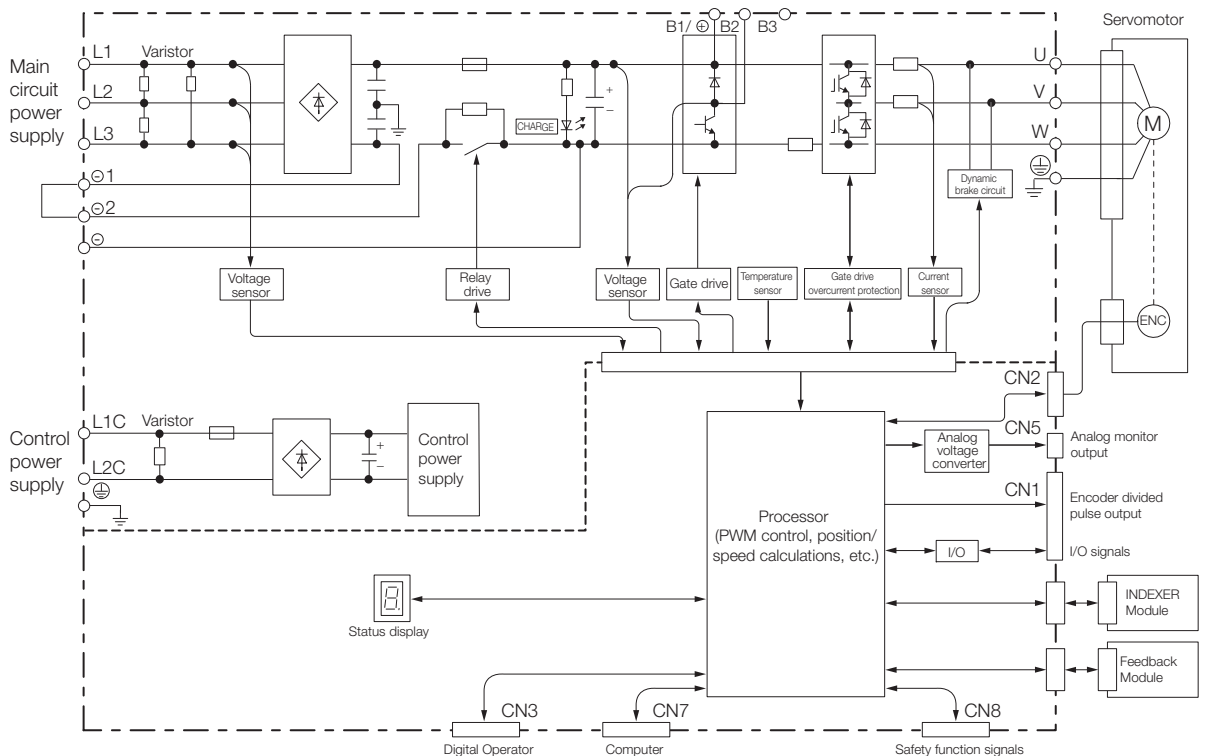

2.2.3 SGD7S-3R8A, -5R5A, and -7R6A

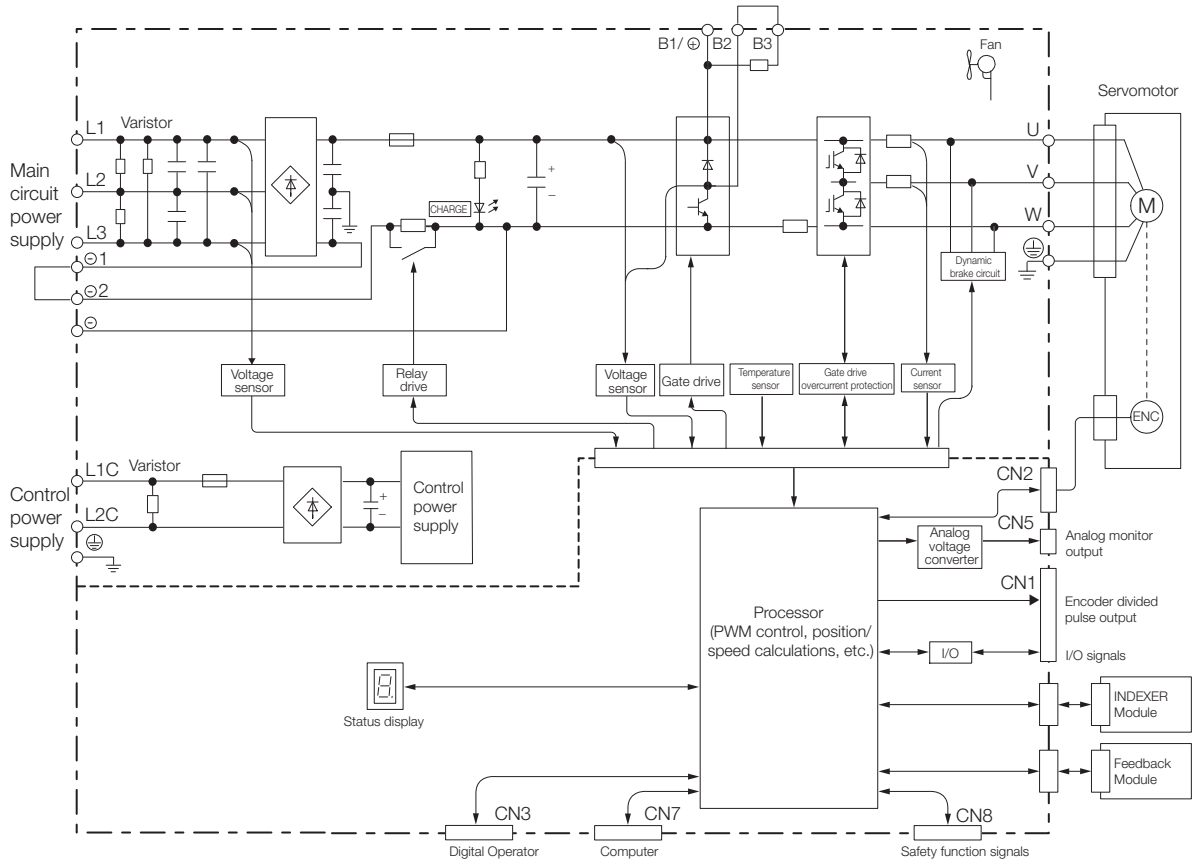

2.2.4 SGD7S-120A

- Standard Specifications: Three-Phase, 200-VAC Power Supply Input

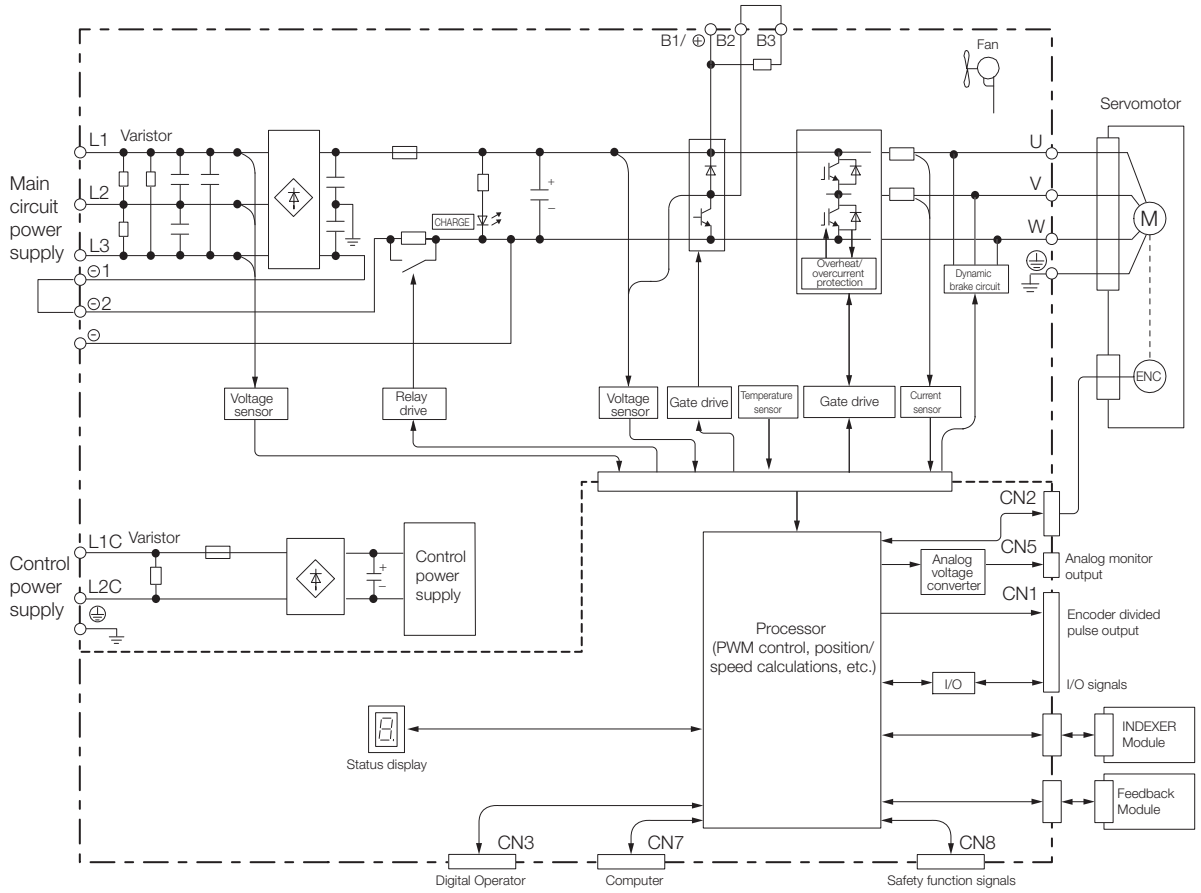

2.2 Block Diagrams

2.2.4 SGD7S-120A

- Optional Specifications: Single-Phase, 200-VAC Power Supply Input (SERVOPACK Model: SGD7S-120AE0A008)

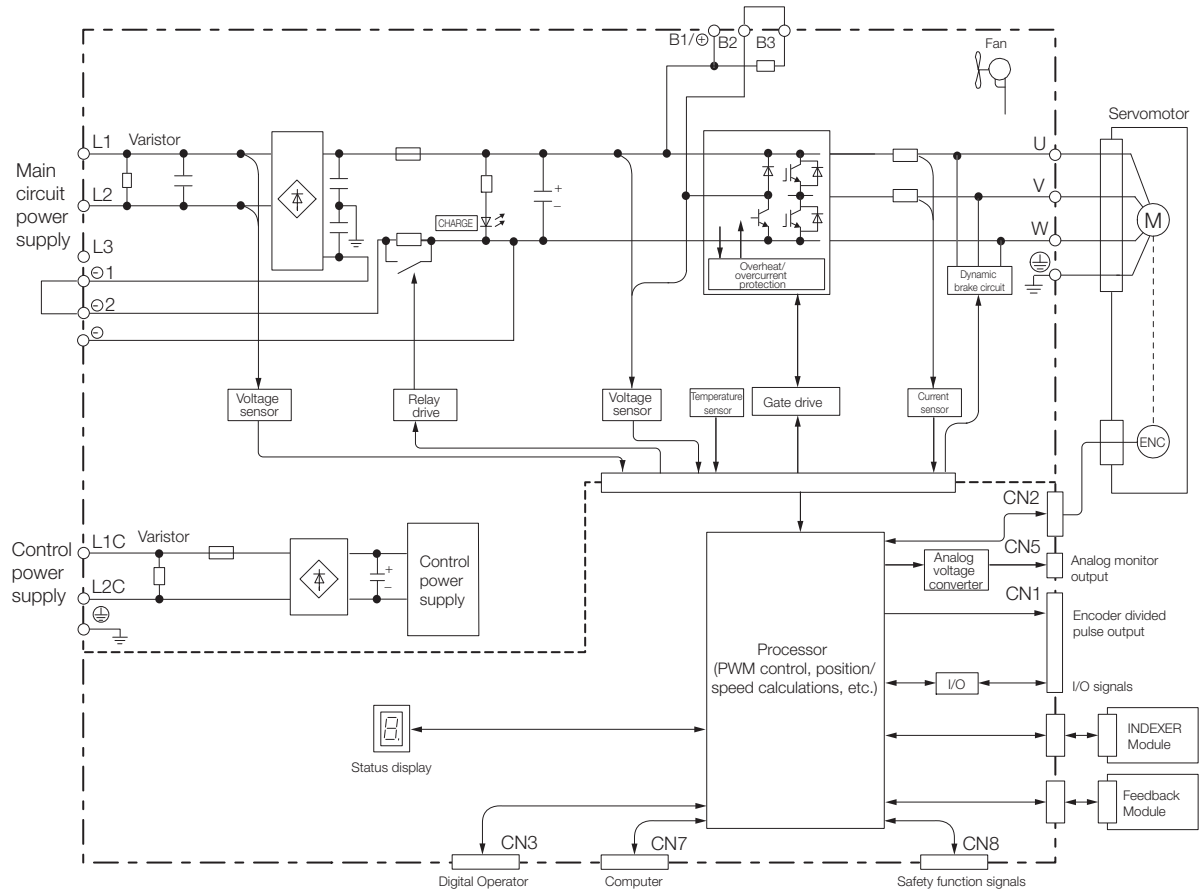

2.2.5 SGD7S-180A and -200A

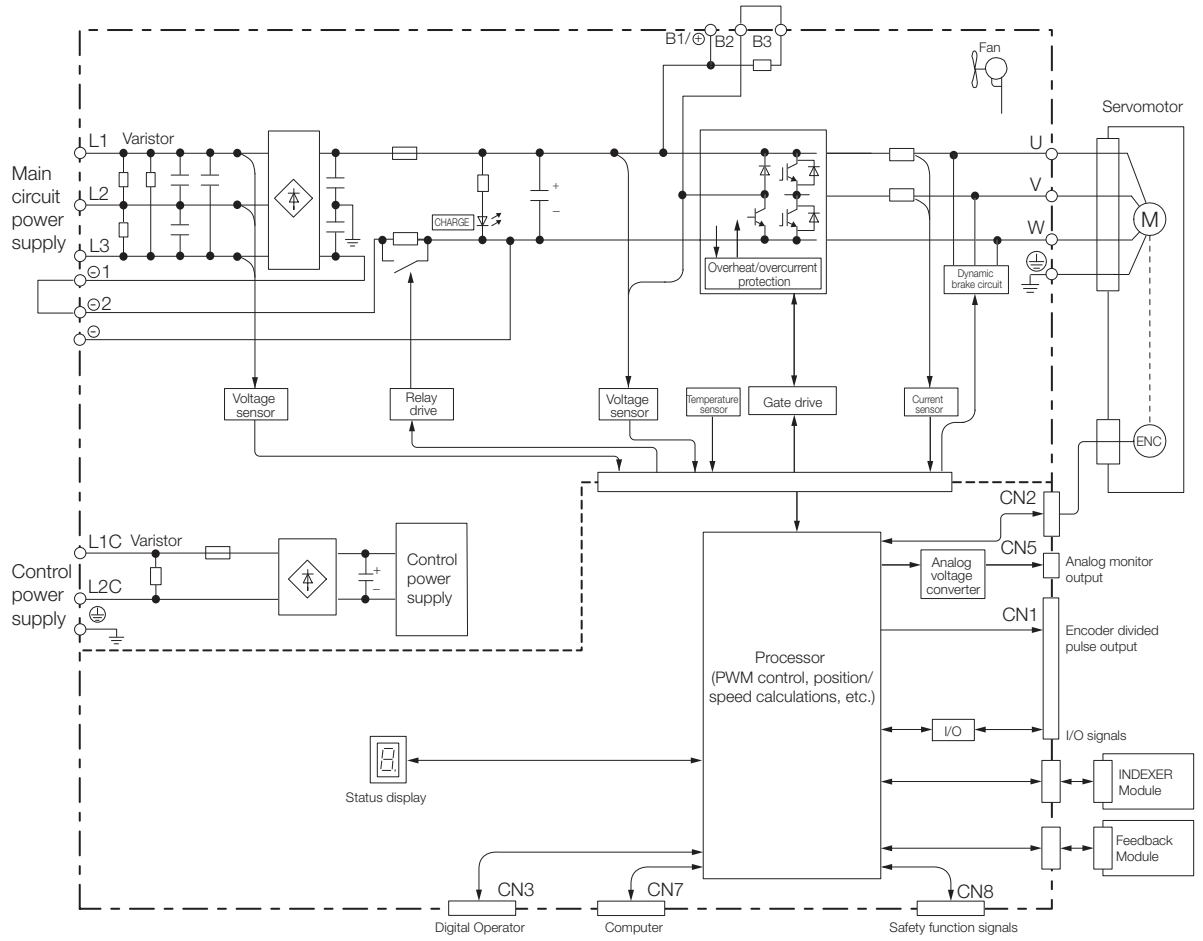

2.2.6 SGD7S-330A

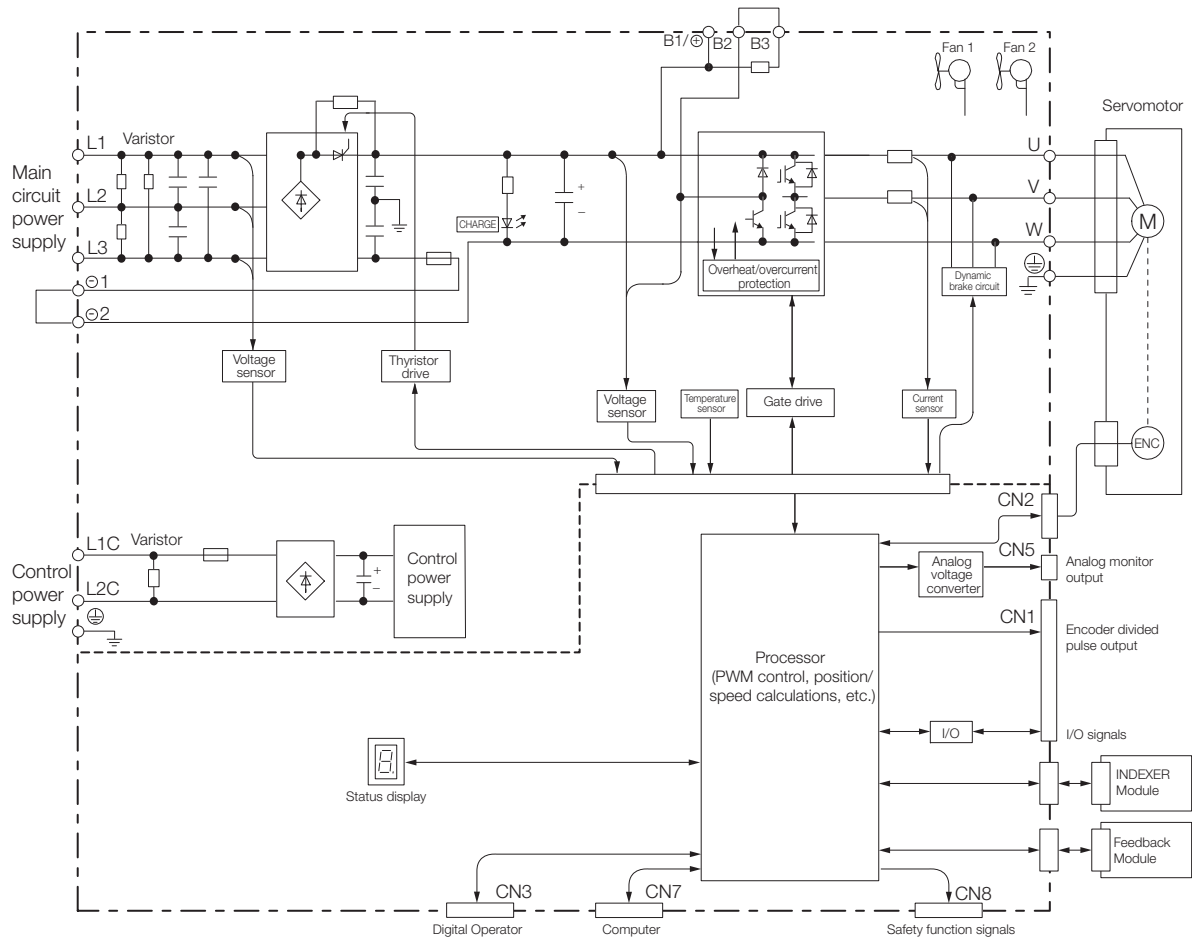

2.2.7 SGD7S-470A and -550A

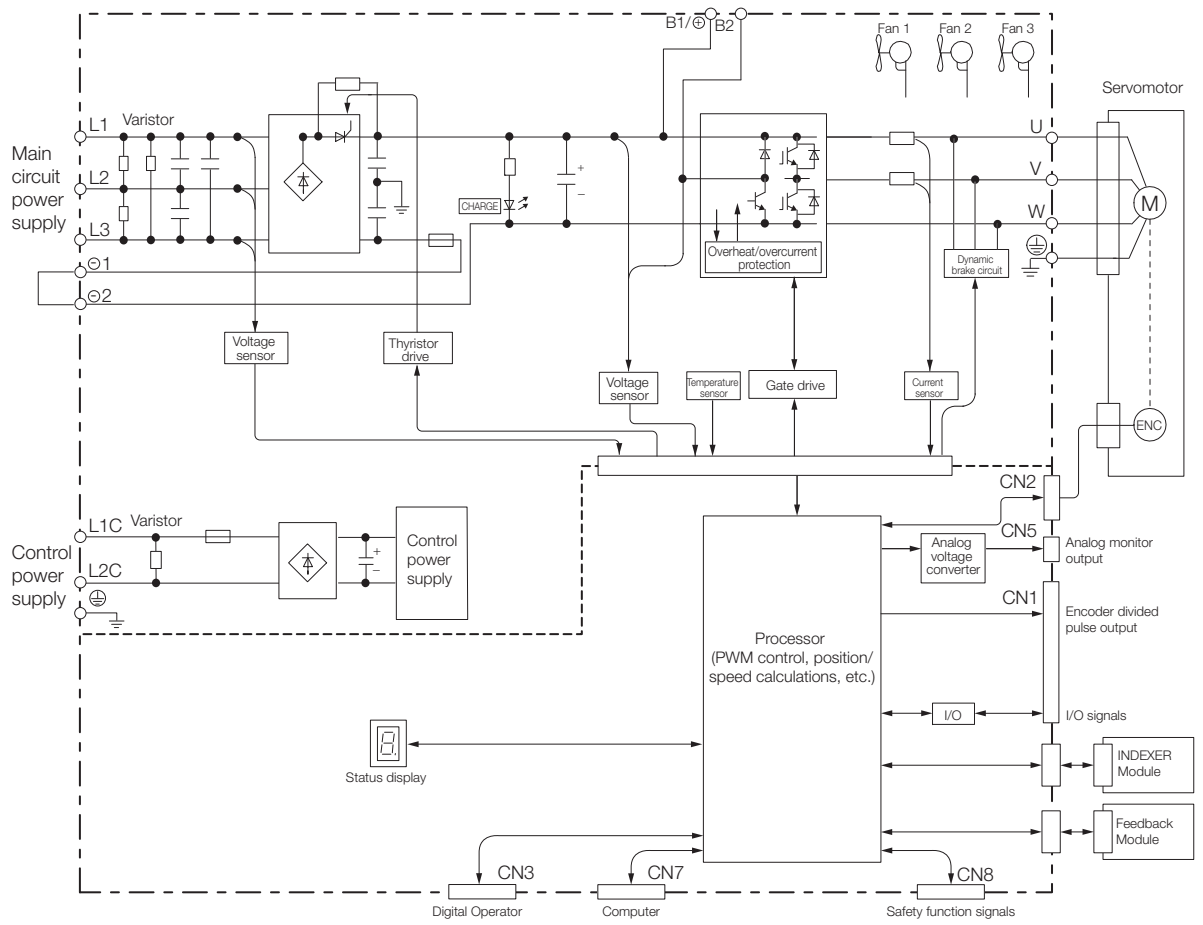

2.2.8 SGD7S-590A and -780A

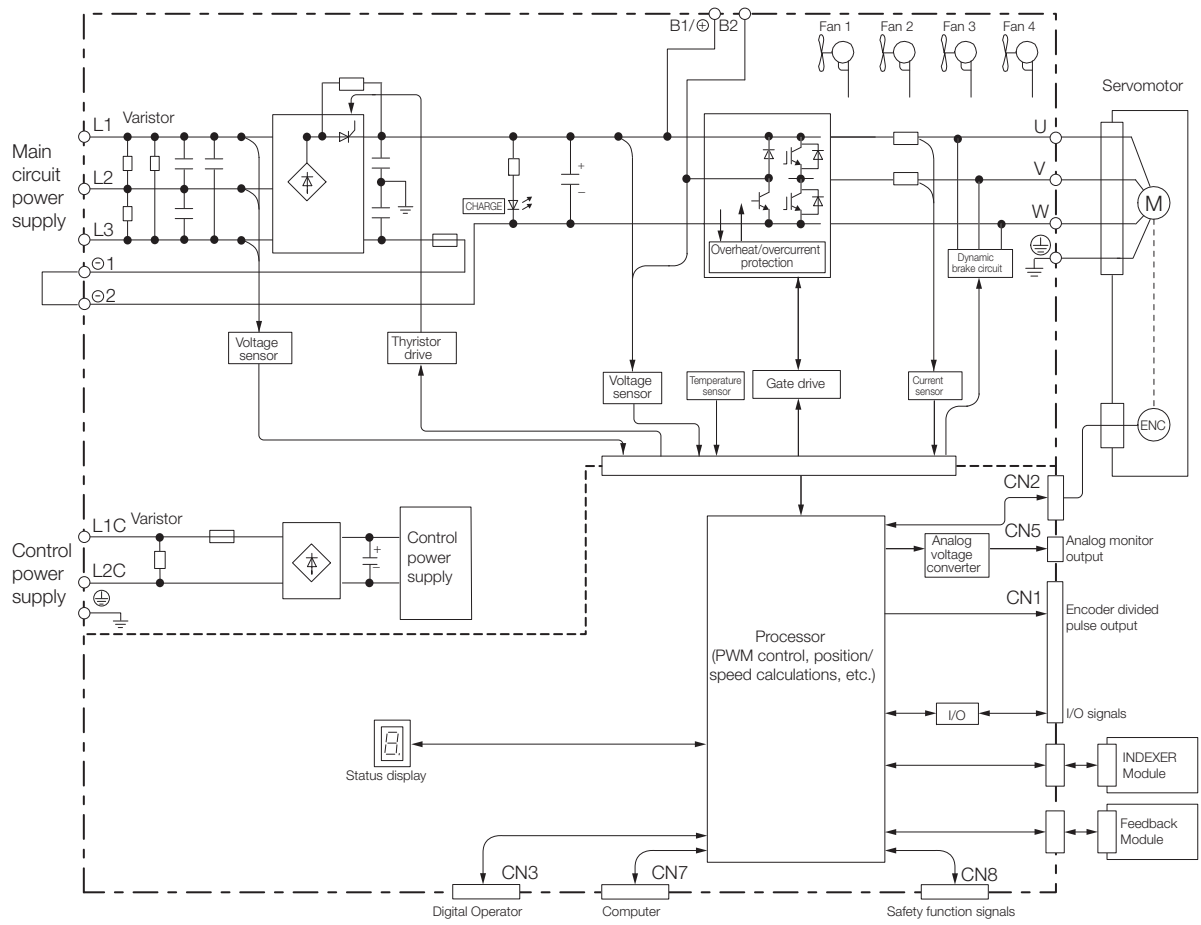

2.2.9 SGD7S-R70F, -R90F, and -2R1F

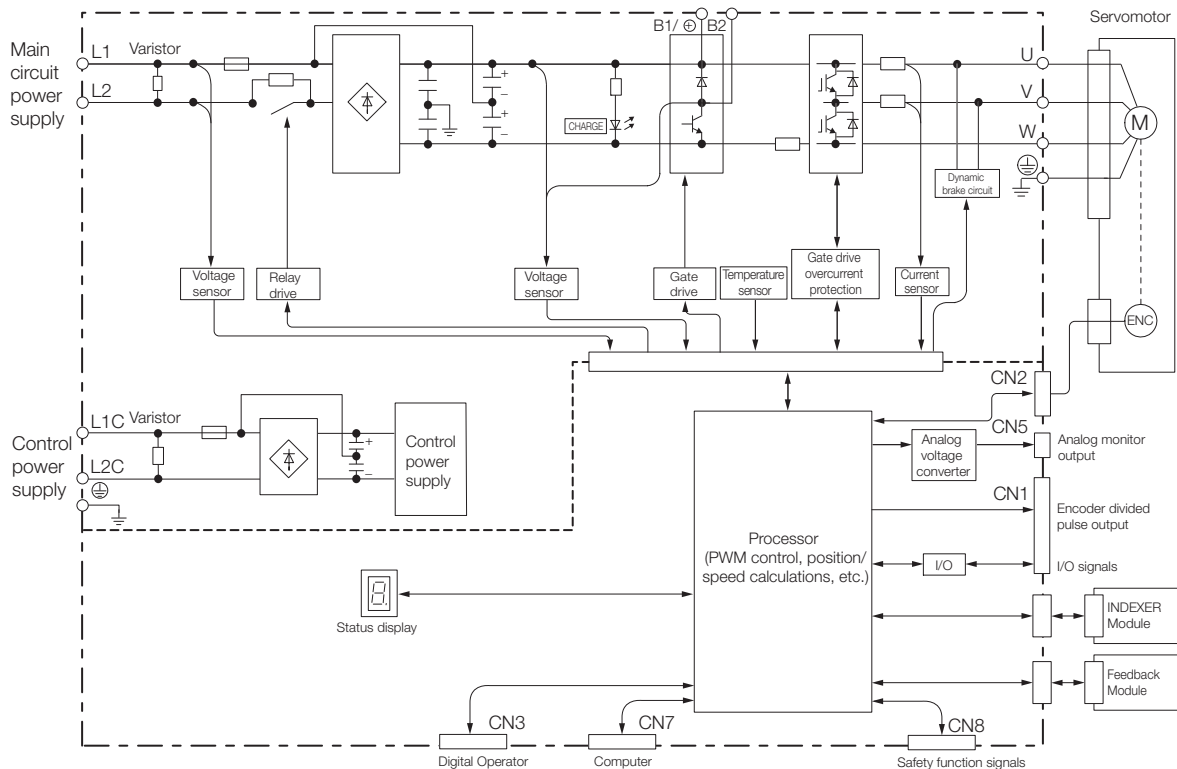

Selecting a SERVOPACK

2

2.2.10 SGD7S-2R8F

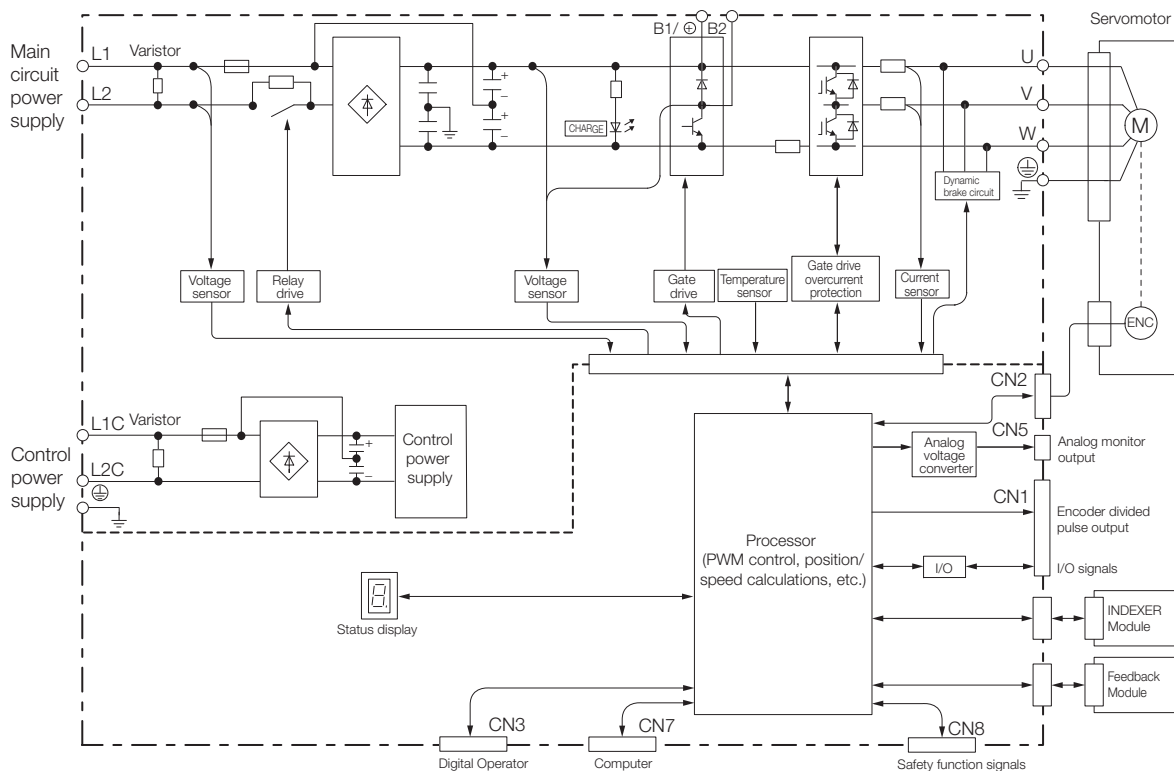

2.3 External Dimensions

2.3.1 Front Cover Dimensions and Connector Specifications

2.3 External Dimensions

2.3.1 Front Cover Dimensions and Connector Specifications

The front cover dimensions and panel connector section are the same for all models. Refer to the following figures and table.

- Front Cover Dimensions

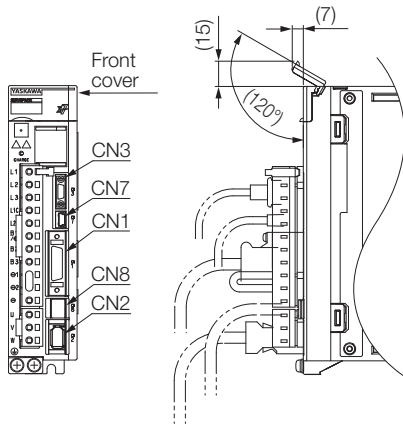

- Connector Specifications

Connector No.	Model	Number of Pins	Manufacturer
CN1	10226-59A3MB	26	3M Japan Limited
CN2	3E106-0220KV	6	3M Japan Limited
CN3	HDR-EC14LFDTN-SLD-PLUS	14	Honda Tsushin Kogyo Co., Ltd.
CN7	2172034-1	5	Tyco Electronics Japan G.K.
CN8	1981080-1	8	Tyco Electronics Japan G.K.

Note: The above connectors or their equivalents are used for the SERVOPACKs.

2.3.2 SERVOPACK External Dimensions

Base-mounted SERVOPACKs

- Three-phase, 200 VAC: SGD7S-R70A, -R90A, and -1R6A

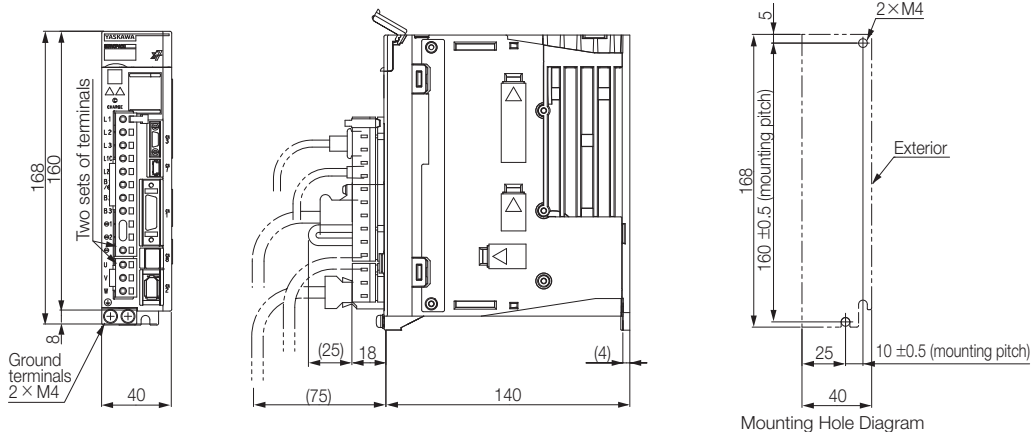

Mounting Hole Diagram
Approx. mass: 0.9 kg
Unit: mm

- Three-phase, 200 VAC: SGD7S-2R8A; Single-phase, 100 VAC: SGD7S-R70F, -R90F, and -2R1F

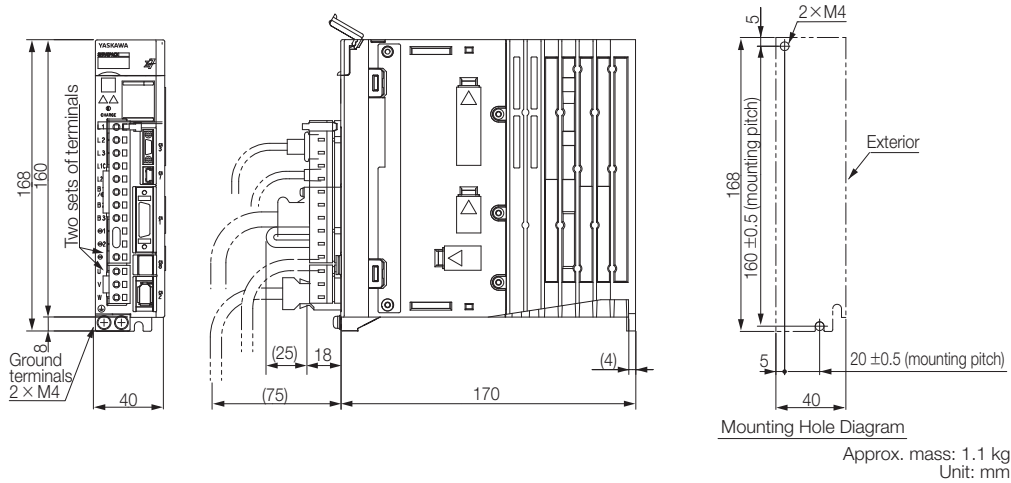

- Three-phase, 200 VAC: SGD7S-3R8A, -5R5A, and -7R6A; Single-phase, 100 VAC: SGD7S-2R8F

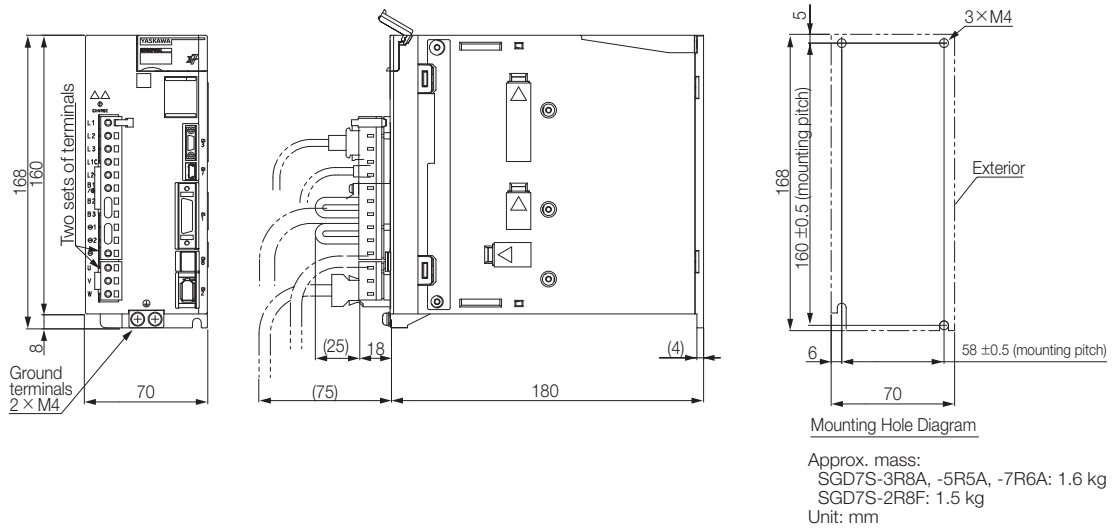

- Three-phase, 200 VAC: SGD7S-120A

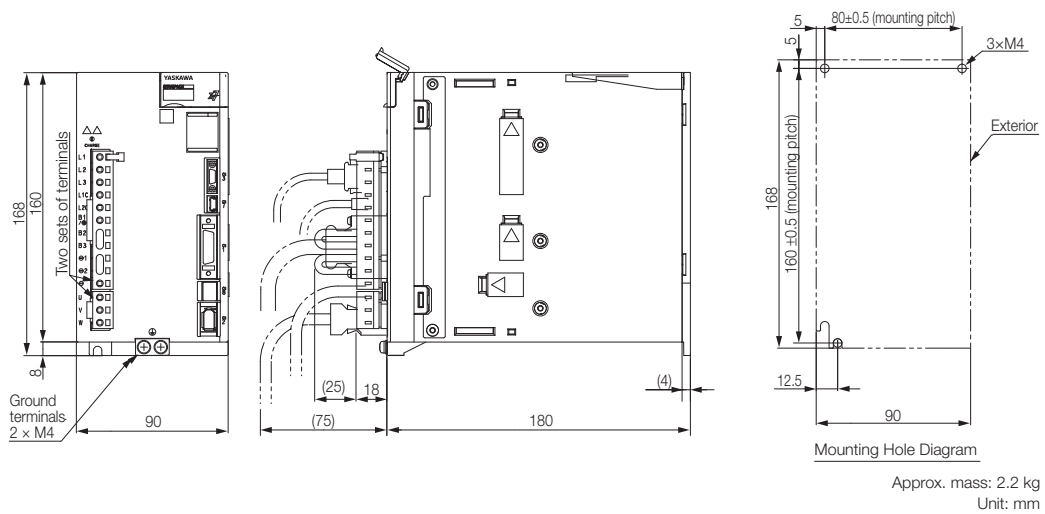

2.3 External Dimensions

2.3.2 SERVOPACK External Dimensions

- Three-phase, 200 VAC: SGD7S-180A and -200A; Single-phase, 200 VAC: SGD7S-120AE0A008

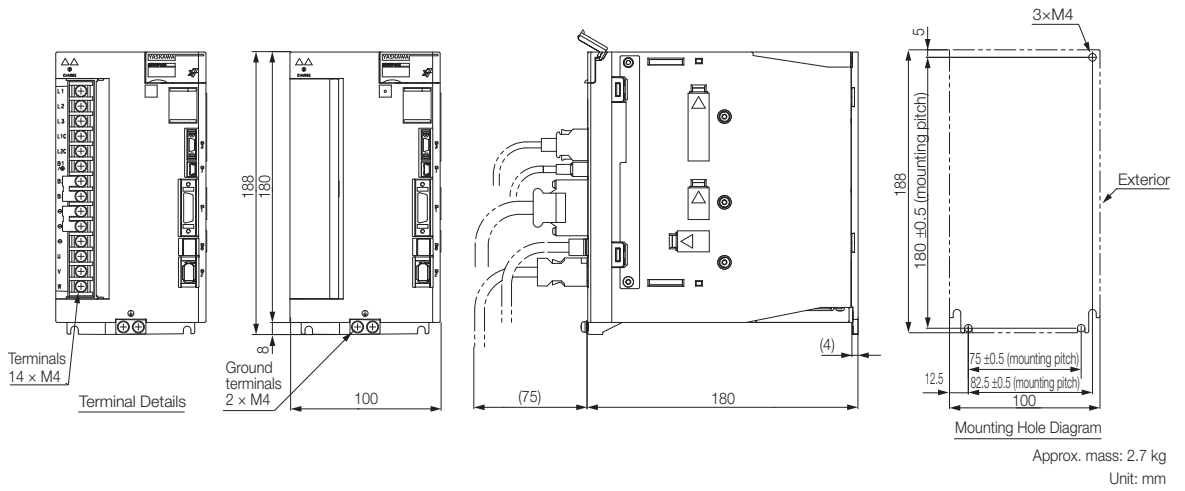

- Three-phase, 200 VAC: SGD7S-330A

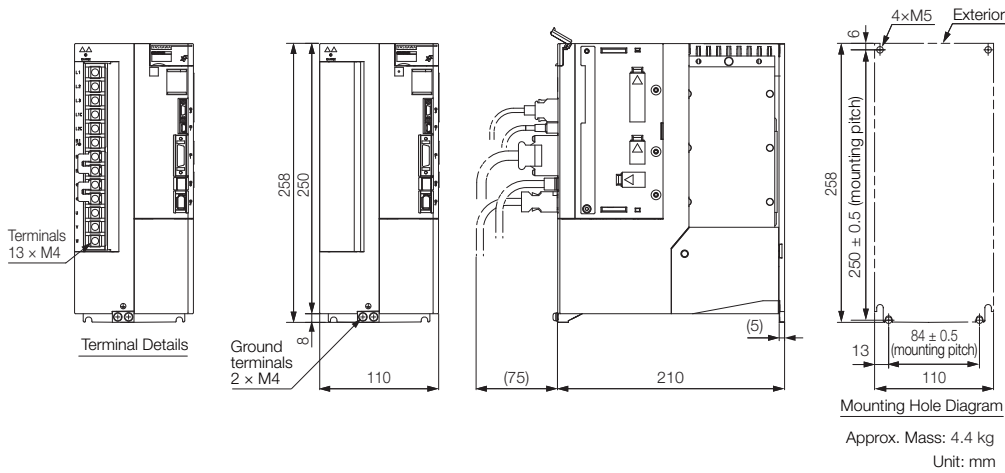

- Three-phase, 200 VAC: SGD7S-470A and -550A

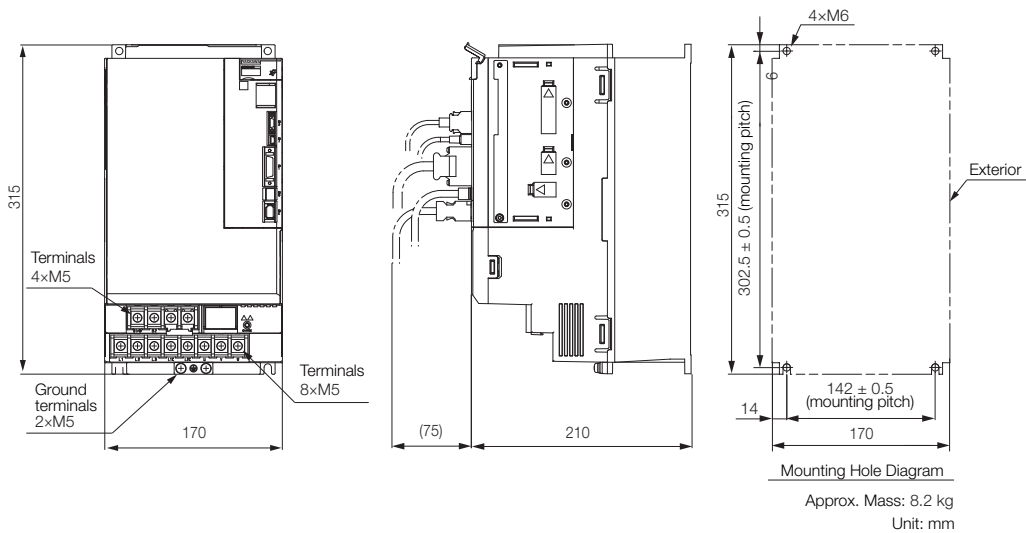

- Three-phase, 200 VAC: SGD7S-590A and -780A

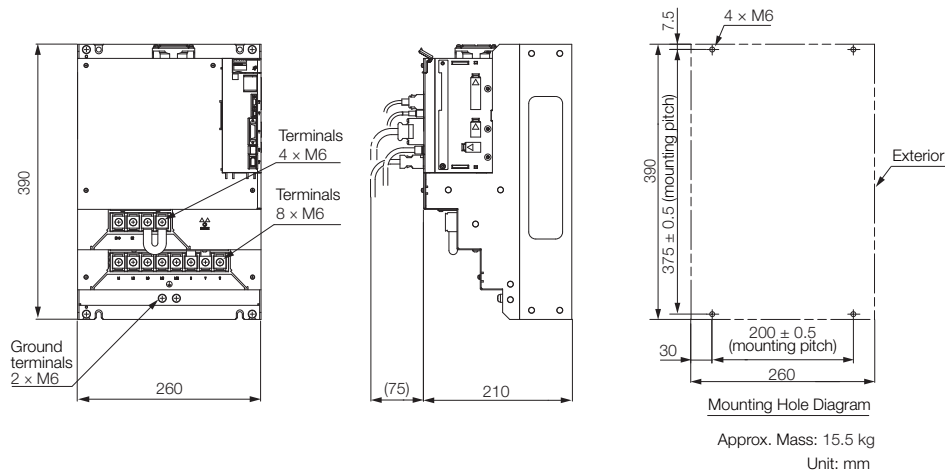

Rack-mounted SERVOPACKs

Hardware Option Code: 001

- Three-phase, 200 VAC: SGD7S-R70A, -R90A, and -1R6A

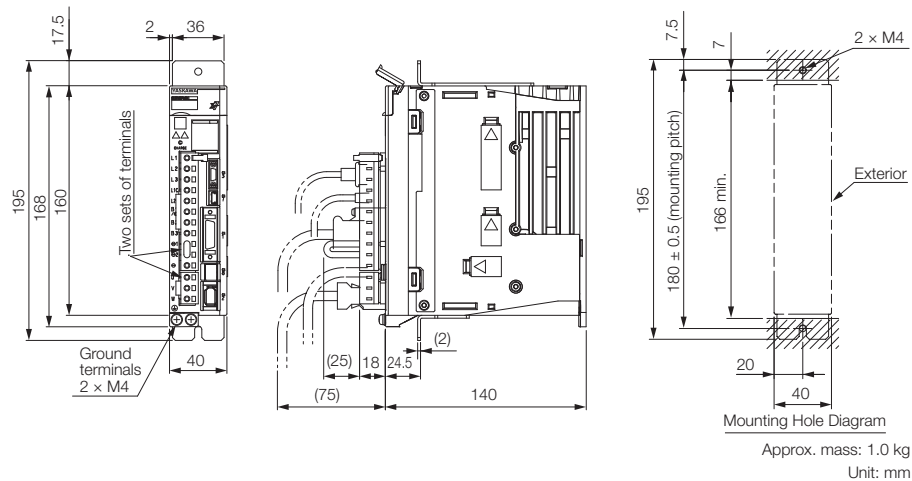

- Three-phase, 200 VAC: SGD7S-2R8A; Single-phase, 100 VAC: SGD7S-R70F, -R90F, and -2R1F

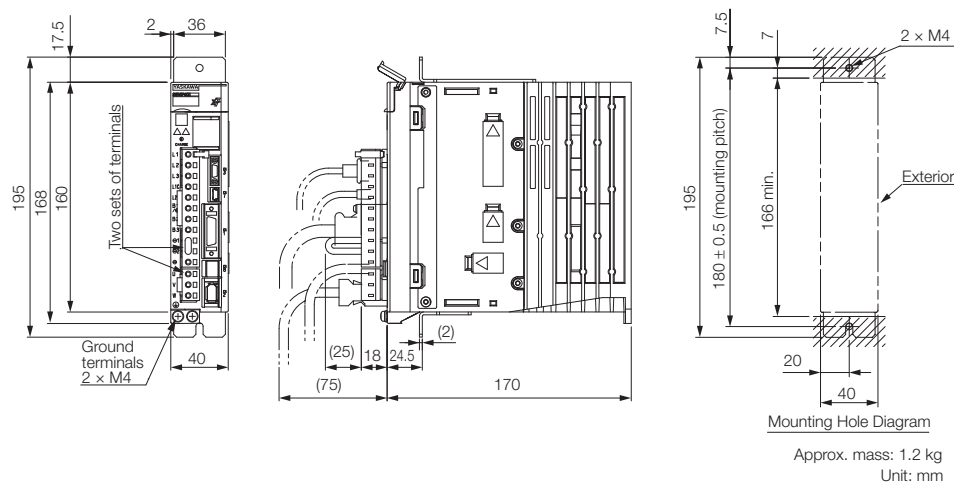

2.3 External Dimensions

2.3.2 SERVOPACK External Dimensions

- Three-phase, 200 VAC: SGD7S-3R8A, -5R5A, and -7R6A; Single-phase, 100 VAC: SGD7S-2R8F

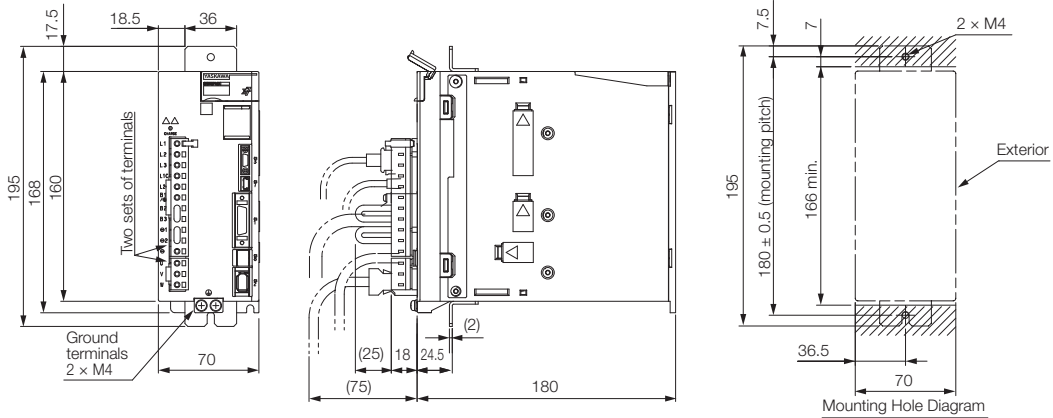

Approx. mass:
SGD7S-3R8A, -5R5A, -7R6A: 1.7 kg
SGD7S-2R8F: 1.6 kg
Unit: mm

- Three-phase, 200 VAC: SGD7S-120A

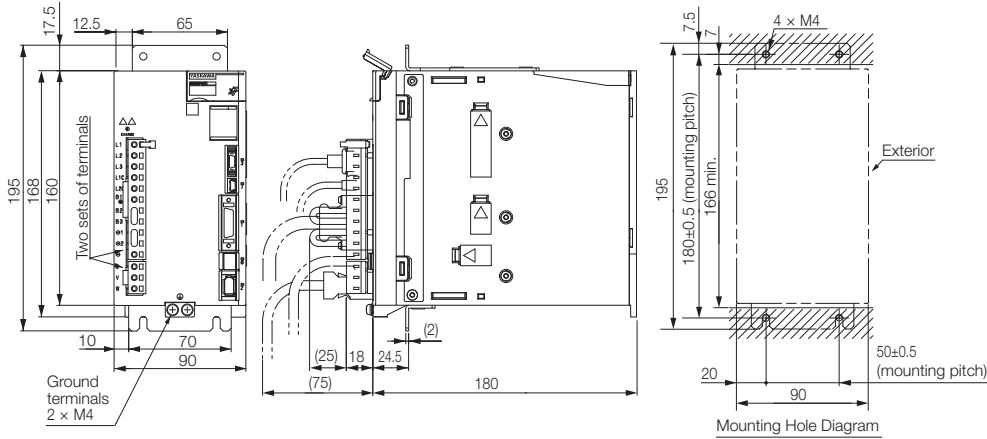

Approx. mass: 2.3 kg
Unit: mm

- Three-phase, 200 VAC: SGD7S-180A and -200A

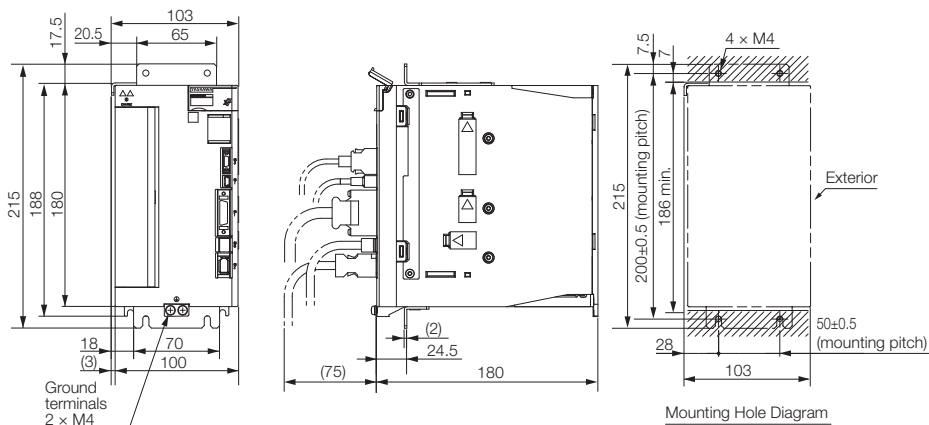

Approx. mass: 2.8 kg
Unit: mm

- Three-phase, 200 VAC: SGD7S-330A

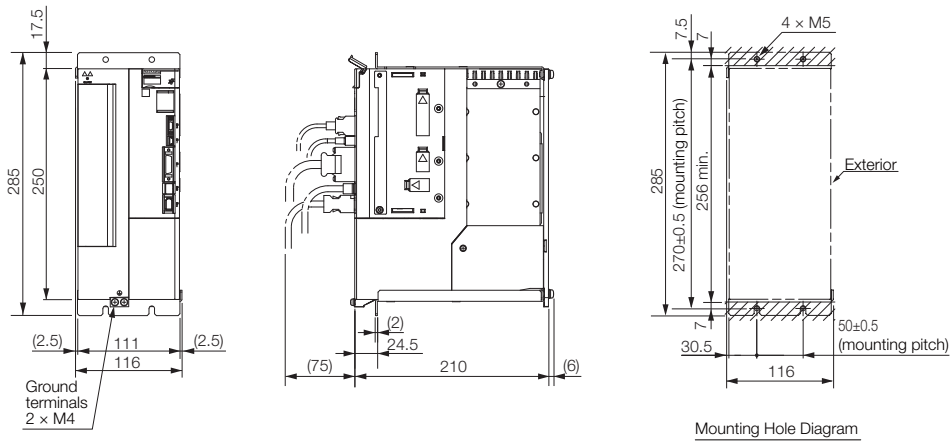

Approx. mass: 4.9 kg
Unit: mm

Duct-ventilated SERVOPACKs

Hardware Option Code: 001

- Three-phase, 200 VAC: SGD7S-470A and -550A

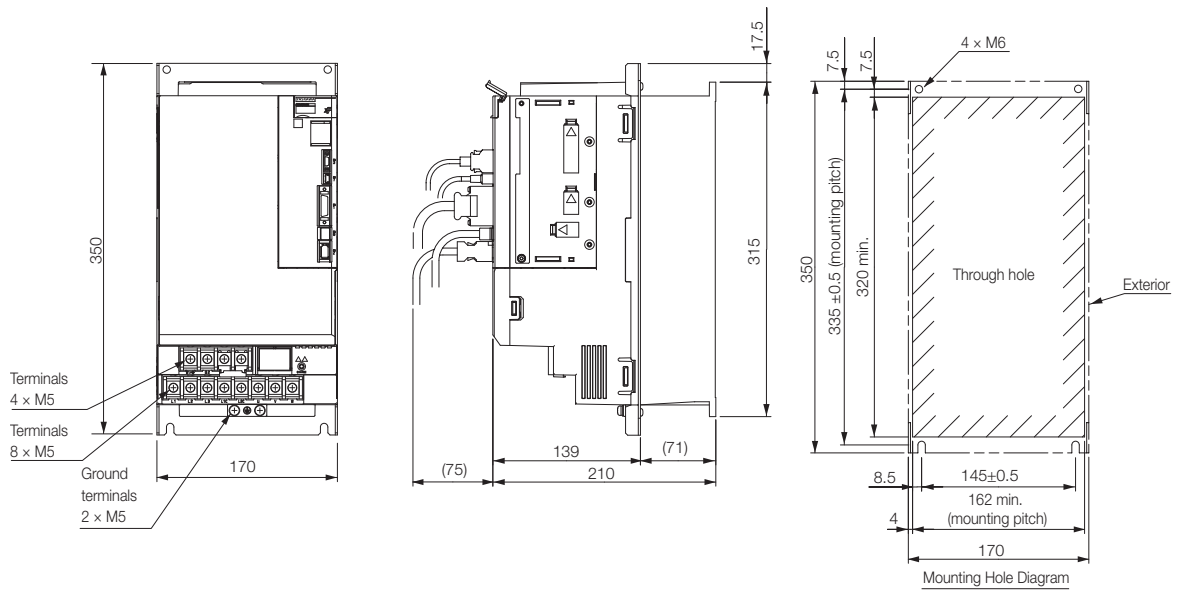

Approx. mass: 8.4 kg
Unit: mm

2.3 External Dimensions

2.3.3 INDEXER Module Dimensions and Connector Specifications

- Three-phase, 200 VAC: SGD7S-590A and -780A

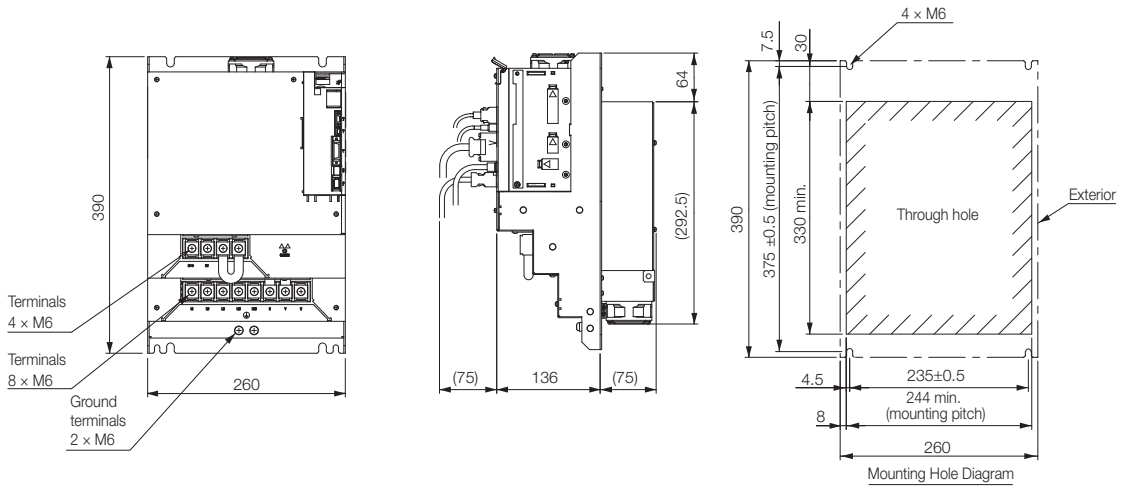

Approx. mass: 13.8 kg
Unit: mm

2.3.3 INDEXER Module Dimensions and Connector Specifications

- External Dimensions

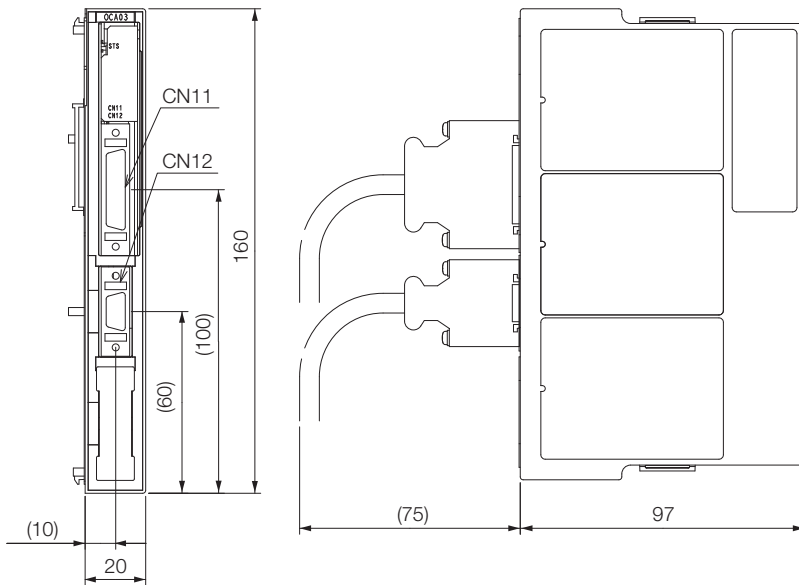

Approx. mass: 0.2 kg
Unit: mm

- Connector Specifications

Connector No.	Model	Number of Pins	Manufacturer
CN11	10236-52A2PL	36	3M Japan Ltd.
CN12	10214-52A2PL	14	3M Japan Ltd.

Note: The above connectors or their equivalents are used for the SERVOPACKs.

2.4 Examples of Standard Connections between SERVOPACKs and Peripheral Devices

• Rotary Servomotors

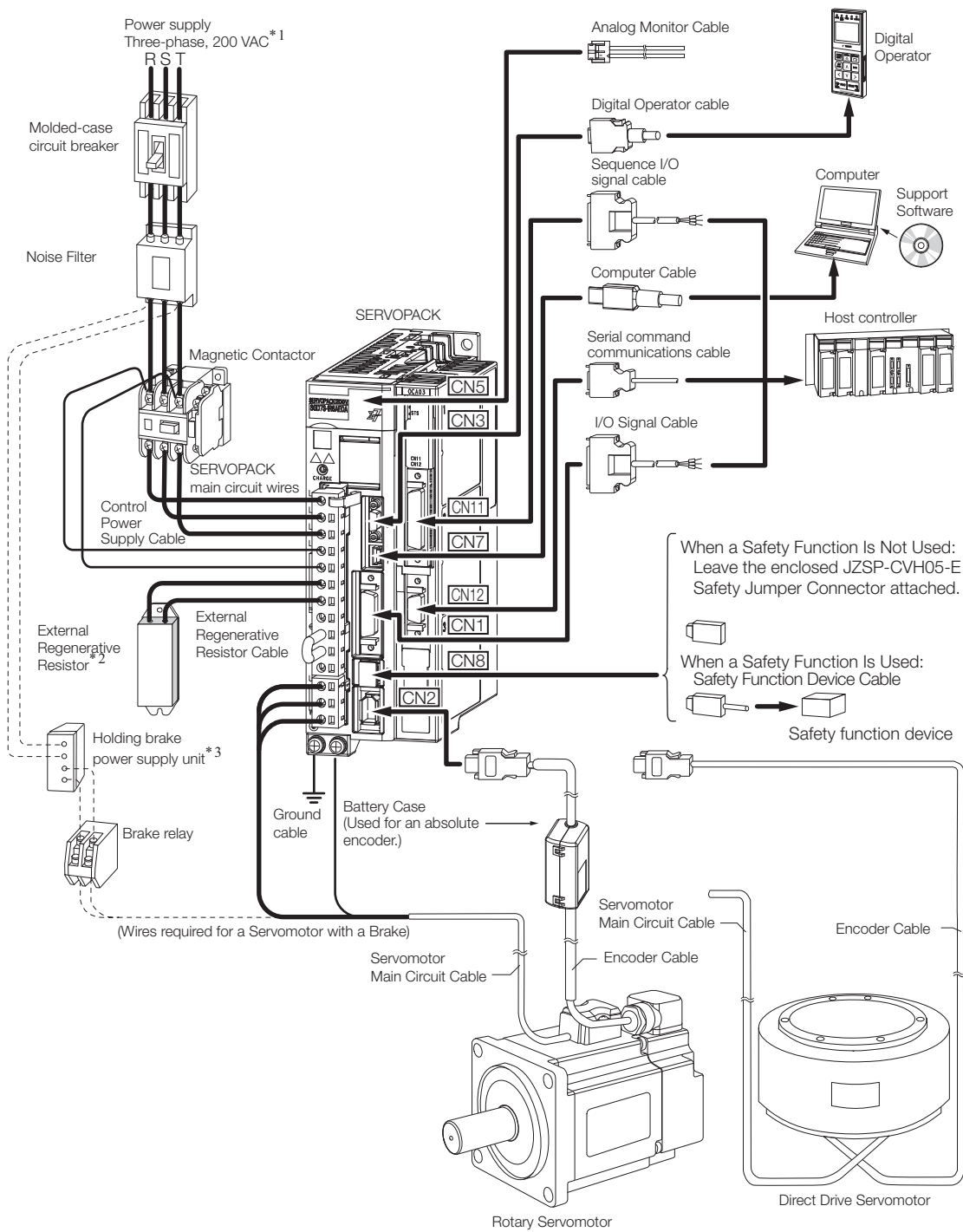

*1. This example is for a SERVOPACK with a three-phase, 200-VAC power supply input. The pin layout of the main circuit connector depends on the voltage.
 *2. External Regenerative Resistors are not provided by Yaskawa.
 *3. The power supply for the holding brake is not provided by Yaskawa. Select a power supply based on the holding brake specifications.
 If you use a 24-V brake, install a separate power supply for the 24-VDC power supply from other power supplies, such as the one for the I/O signals of the CN1 connector.
 If the power supply is shared, the I/O signals may malfunction.

• Linear Servomotors

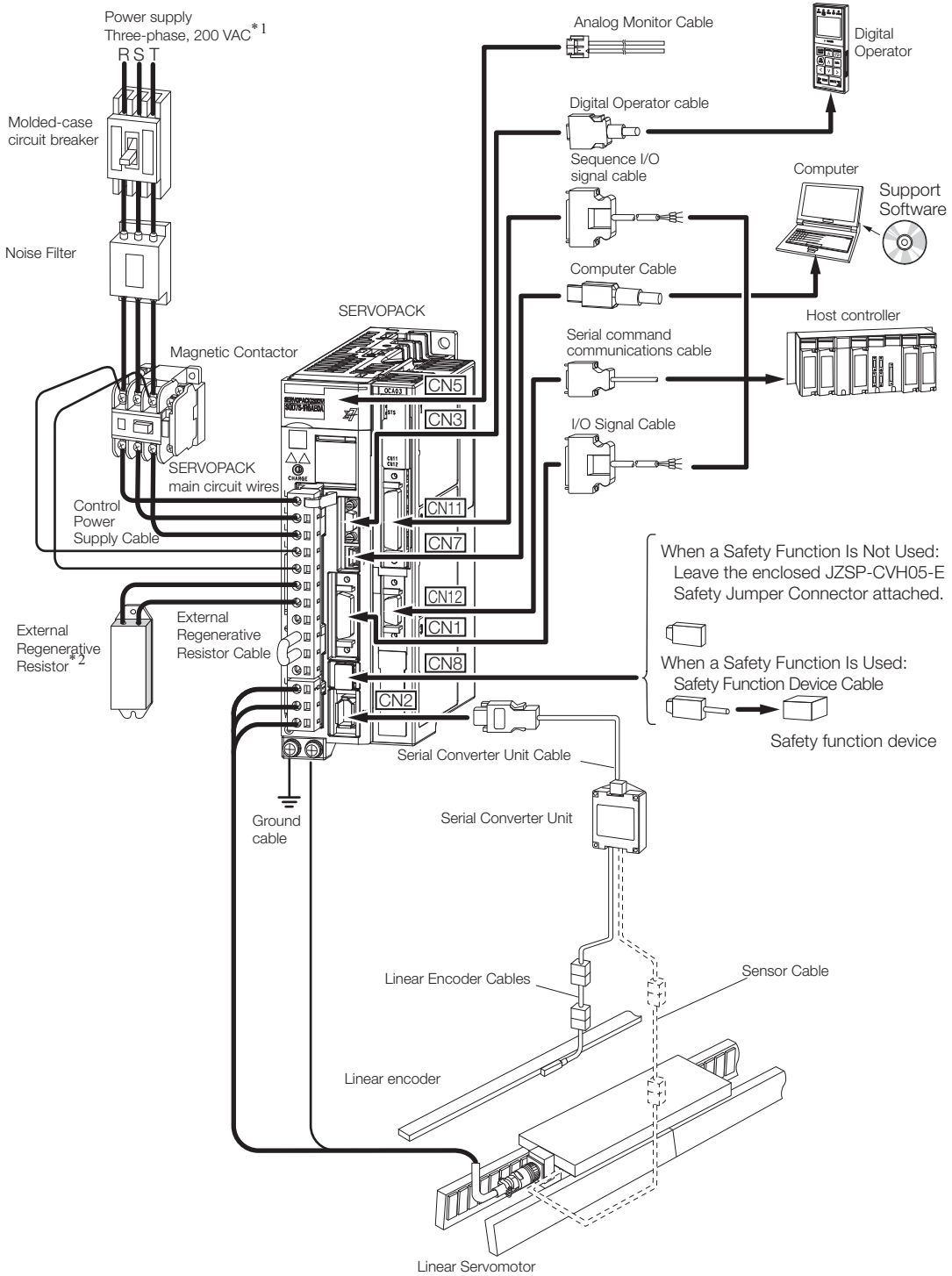

*1. This example is for a SERVOPACK with a three-phase, 200-VAC power supply input. The pin layout of the main circuit connector depends on the voltage.

*2. External Regenerative Resistors are not provided by Yaskawa.

Installation

3

This chapter provides information on installing SERVOPACKs and INDEXER Modules in the required locations.

3.1	Installation Precautions	3-2
3.2	Attaching the INDEXER Module to the SERVOPACK . .	3-3
3.3	Mounting Types and Orientation	3-4
3.4	Mounting Hole Dimensions	3-5
3.5	Mounting Interval	3-7
3.5.1	Installing One SERVOPACK in a Control Panel . .	3-7
3.5.2	Installing More Than One SERVOPACK in a Control Panel	3-7
3.6	Monitoring the Installation Environment . . .	3-8
3.7	EMC Installation Conditions	3-9

3.1 Installation Precautions

Refer to the following section for the ambient installation conditions.

 2.1.4 Specifications on page 2-7

■ Installation Near Sources of Heat

Implement measures to prevent temperature increases caused by radiant or convection heat from heat sources so that the ambient temperature of the SERVOPACK meets the ambient conditions.

■ Installation Near Sources of Vibration

Install a vibration absorber on the mounting surface of the SERVOPACK so that the SERVOPACK will not be subjected to vibration.

■ Other Precautions

Do not install the SERVOPACK in a location subject to high temperatures, high humidity, water drops, cutting oil, excessive dust, excessive dirt, excessive iron powder, corrosive gasses, or radioactivity.

3.2**Attaching the INDEXER Module to the SERVOPACK**

Install the INDEXER Module correctly according to the installation procedures that are included with it.

📖 Σ -V-Series/ Σ -V-Series for Large-Capacity Models/ Σ -7-Series Installation Guide Command Option Module (TOBP C720829 01).

3.3 Mounting Types and Orientation

The SERVOPACKs come in the following mounting types: base-mounted, rack-mounted, and duct-ventilated types. Regardless of the mounting type, mount the SERVOPACK vertically, as shown in the following figures.

Also, mount the SERVOPACK so that the front panel is facing toward the operator.

Note: Prepare two to four mounting holes for the SERVOPACK and mount it securely in the mounting holes. (The number of mounting holes depends on the capacity of the SERVOPACK.)

- Base-mounted SERVOPACK

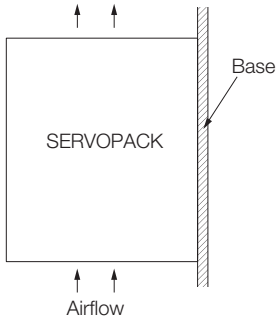

- Rack-mounted SERVOPACK

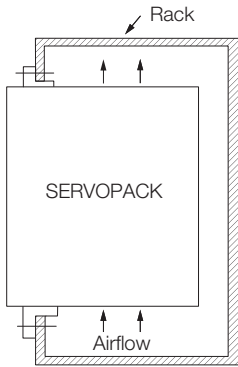

- Duct-ventilated SERVOPACK

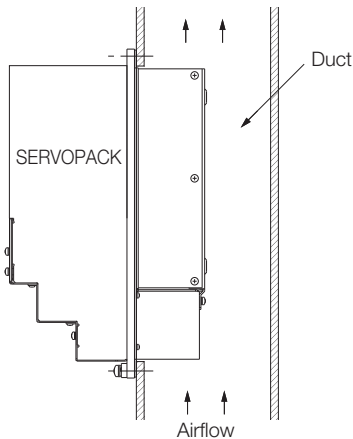

3.4

Mounting Hole Dimensions

Use mounting holes to securely mount the SERVOPACK to the mounting surface.

Note: To mount the SERVOPACK, you will need to prepare a screwdriver that is longer than the depth of the SERVOPACK.

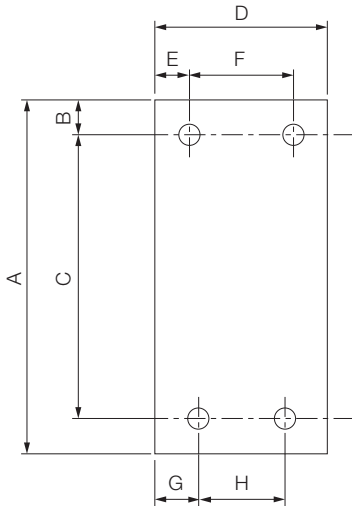

◆ Σ -7-series Mounting Hole Dimensions

SERVOPACK Model	Dimensions (mm)									Screw Size	Number of Screws
	A	B	C	D	E	F	G	H			
SGD7S-	R70A, R90A, 1R6A	168	5	160 ±0.5	40	35	–	25	–	M4	2
	2R8A, R70F, R90F, 2R1F	168	5	160 ±0.5	40	5	–	25	–	M4	2
	3R8A, 5R5A, 7R6A, 2R8F	168	5	160 ±0.5	70	6	58 ±0.5	64	–	M4	3
	120A	168	5	160 ±0.5	90	5	80 ±0.5	12.5	–	M4	3
	180A, 200A, 120AE0A008	188	5	180 ±0.5	100	95	–	12.5	75 ±0.5	M4	3
	330A	258	6	250 ±0.5	110	5	100 ±0.5	13	84 ±0.5	M5	4
	470A, 550A	315	6	302.5 ±0.5	170	14	142 ±0.5	14	142 ±0.5	M6	4
590A, 780A	390	7.5	375 ±0.5	260	30	200 ±0.5	30	200 ±0.5	M6	4	

◆ Σ -V-series-Compatible Mounting Hole Dimensions

If you are replacing a Σ -V-Series SERVOPACK with a Σ -7-Series SERVOPACK, you can also use the mounting holes that were used for the Σ -V-Series SERVOPACK. Refer to the following table.

SERVOPACK Model		Dimensions (mm)								Screw Size	Number of Screws
		A	B	C	D	E	F	G	H		
SGD7S-	R70A, R90A, 1R6A	168	5	150 ±0.5	40	35	–	35	–	M4	2
	2R8A, R70F, R90F, 2R1F	168	5	150 ±0.5	40	5	–	35	–	M4	2
	3R8A, 5R5A, 7R6A, 2R8F	168	5	150 ±0.5	70	6	58 ±0.5	6	–	M4	3
	120A	168	5	150 ±0.5	90	5	80 ±0.5	5	–	M4	3
	180A, 200A, 120AE0A008	188	5	170 ±0.5	100	95	–	5	90 ±0.5	M4	3
	330A	250	6	238.5 ±0.5	110	5	100 ±0.5	5	100 ±0.5	M5	4
	470A, 550A, 590A, 780A	A mounting compatibility attachment is required. The attachment is not provided by Yaskawa. Contact your Yaskawa representative for details.									

3.5 Mounting Interval

3.5.1 Installing One SERVOPACK in a Control Panel

Provide the following spaces around the SERVOPACK.

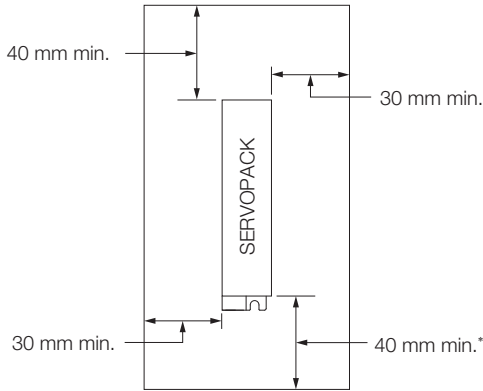

* For this dimension, ignore items protruding from the main body of the SERVOPACK.

3.5.2 Installing More Than One SERVOPACK in a Control Panel

When multiple SERVOPACKs are installed close together in an enclosed space, natural convection may provide insufficient air circulation to distribute heat uniformly through the space, resulting in the air surrounding the SERVOPACKs to locally exceed the surrounding air temperature range. In this case, you must take measures to disperse the localized hot spots, such as by using fans. When using fans, install them as shown below.

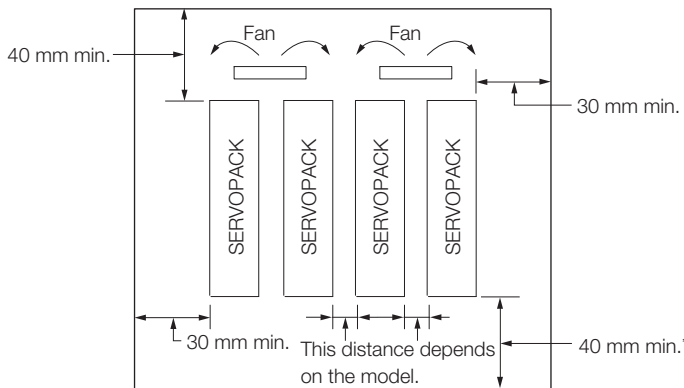

* For this dimension, ignore items protruding from the main body of the SERVOPACK.

The space required on the right side of a SERVOPACK (when looking at the SERVOPACK from the front) depends on the SERVOPACK models. Refer to the following table.

SERVOPACK Model	Space on Right Side	Cooling Fan Installation Conditions
		10 mm above SERVOPACK's Top Surface
SGD7S-	R70A, R90A, 1R6A, 2R8A, 3R8A, 5R5A, 7R6A, R70F, R90F, 2R1F, 2R8F	Air speed: 0.5 m/s min.
	120A, 180A, 200A, 330A, 470A, 550A, 590A, 780A	Air speed: 0.5 m/s min.

Note: When option modules are mounted on SERVOPACKs, the SERVOPACK installation conditions will depend on the option modules that are mounted. For details, refer to the manual for option module.

3.6 Monitoring the Installation Environment

You can use the SERVOPACK Installation Environment Monitor parameter to check the operating conditions of the SERVOPACK in the installation environment.

You can check the SERVOPACK installation environment monitor with either of the following methods.

- Using the SigmaWin+: **Life Monitor - Installation Environment Monitor - SERVOPACK**
- Digital Operator: Un025 (Installation Environment Monitor [%])

Implement one or more of the following actions if the monitor value exceeds 100%.

- Lower the surrounding temperature.
- Decrease the load.

Information The value of the SERVOPACK Installation Environment Monitor parameter will increase by about 10% for each 10°C increase in the ambient temperature.



Important

Always observe the surrounding air temperature given in the SERVOPACK environment conditions. Even if the monitor value is 100% or lower, you cannot use a SERVOPACK in a location that exceeds the specified surrounding air temperature.

3.7 EMC Installation Conditions

This section gives the recommended installation conditions that were used for EMC certification testing.

The EMC installation conditions that are given here are the conditions that were used to pass testing criteria at Yaskawa. The EMC level may change under other conditions, such as the actual installation structure and wiring conditions. These Yaskawa products are designed to be built into equipment. Therefore, you must implement EMC measures and confirm compliance for the final equipment.

The compliant standards are EN 55011 Group 1, Class A, EN 61000-6-2, EN 61000-6-4, and EN 61800-3 (Category C2, Second environment).



WARNING

- In a domestic environment, this product may cause radio interference in which case supplementary mitigation measures may be required.



CAUTION

- This equipment is not intended for use in residential environments and may not provide adequate protection to radio reception in such environments.

• Three-Phase, 200 VAC

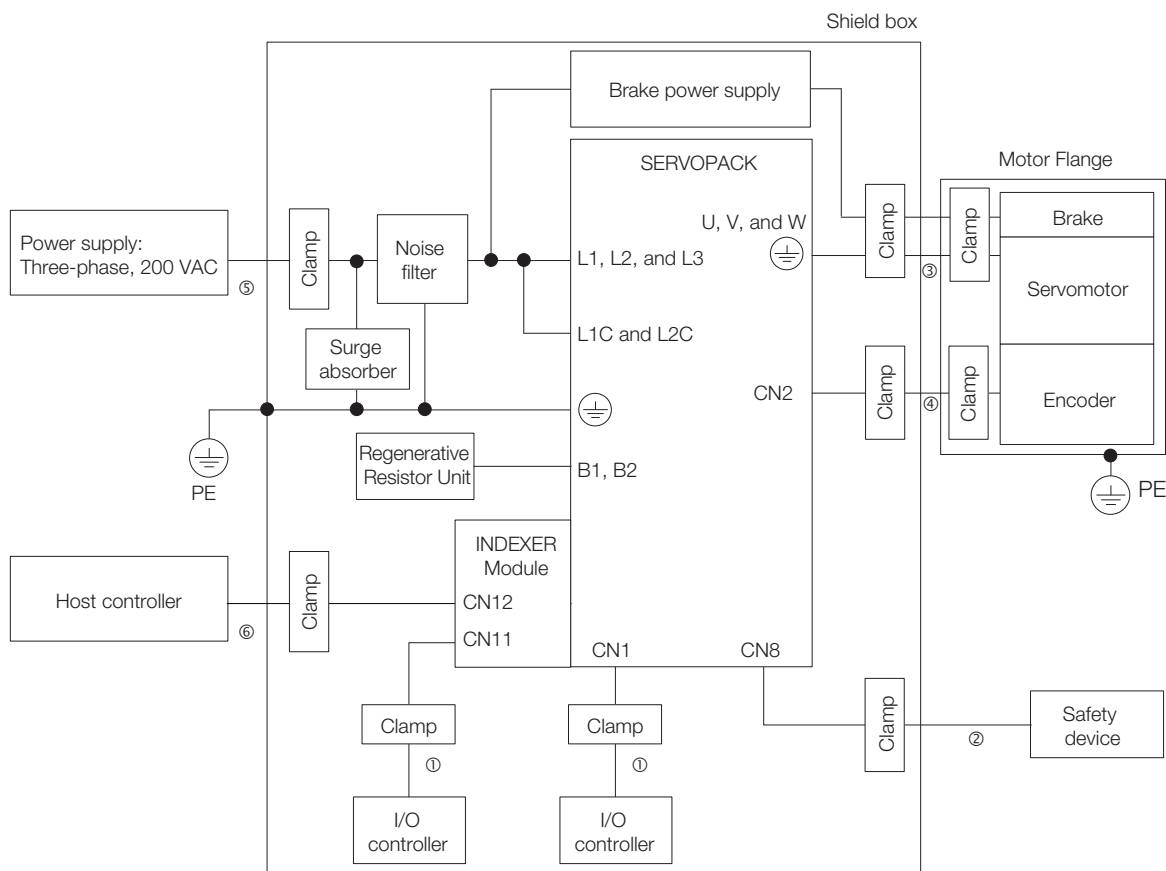

Symbol	Cable Name	Specification
①	I/O Signal Cable	Shielded cable
②	Safety Function Device Cable	Shielded cable
③	Servomotor Main Circuit Cable	Shielded cable
④	Encoder Cable	Shielded cable
⑤	Main Circuit Power Cable	Shielded cable
⑥	Cable for Serial Command Communications	Shielded cable

- Single-Phase, 200 VAC

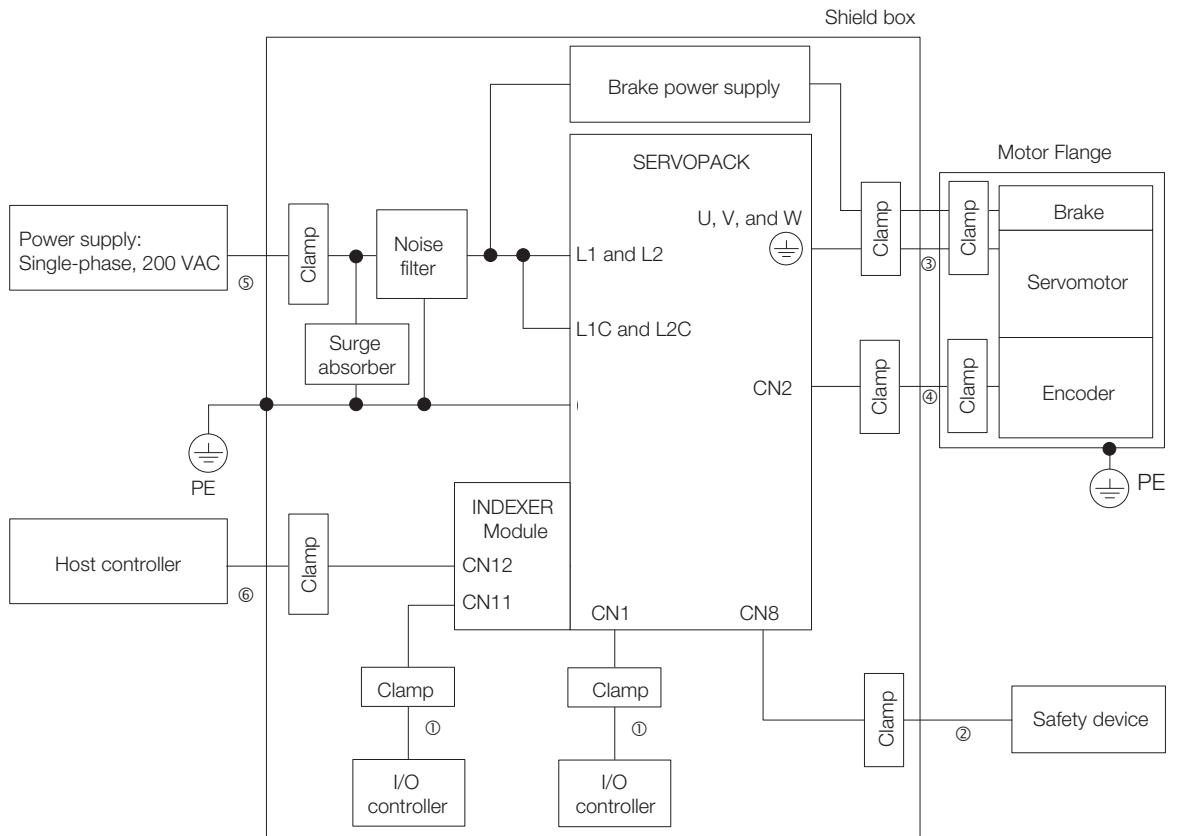

Symbol	Cable Name	Specification
①	I/O Signal Cable	Shielded cable
②	Safety Function Device Cable	Shielded cable
③	Servomotor Main Circuit Cable	Shielded cable
④	Encoder Cable	Shielded cable
⑤	Main Circuit Power Cable	Shielded cable
⑥	Cable for Serial Command Communications	Shielded cable

• Single-Phase, 100 VAC

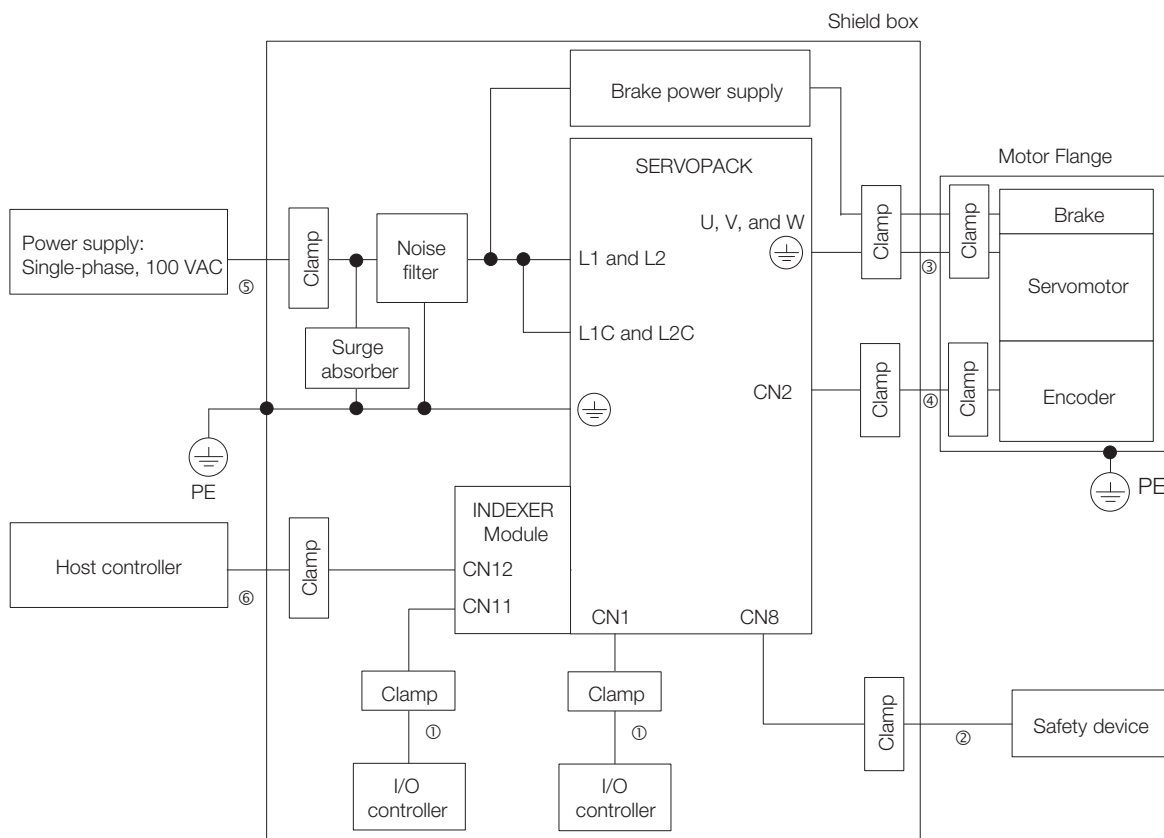

Symbol	Cable Name	Specification
①	I/O Signal Cable	Shielded cable
②	Safety Function Device Cable	Shielded cable
③	Servomotor Main Circuit Cable	Shielded cable
④	Encoder Cable	Shielded cable
⑤	Main Circuit Power Cable	Shielded cable
⑥	Cable for Serial Command Communications	Shielded cable

Wiring and Connecting

4

This chapter provides information on wiring and connecting SERVOPACKs and INDEXER Modules to power supplies and peripheral devices.

4.1	Wiring and Connecting SERVOPACKs	4-3
4.1.1	General Precautions	4-3
4.1.2	Countermeasures against Noise	4-6
4.1.3	Grounding	4-9
4.2	Basic Wiring Diagrams	4-10
4.3	Wiring the Power Supply to the SERVOPACK	4-12
4.3.1	Terminal Symbols and Terminal Names	4-12
4.3.2	Wiring Procedure for Main Circuit Connector	4-14
4.3.3	Power ON Sequence	4-15
4.3.4	Power Supply Wiring Diagrams	4-17
4.3.5	Wiring Regenerative Resistors	4-23
4.3.6	Wiring Reactors for Harmonic Suppression	4-25
4.4	Wiring Servomotors	4-26
4.4.1	Terminal Symbols and Terminal Names	4-26
4.4.2	Pin Arrangement of Encoder Connector (CN2)	4-26
4.4.3	Wiring the SERVOPACK to the Encoder	4-27
4.4.4	Wiring the SERVOPACK to the Holding Brake	4-35
4.5	I/O Signal Connections	4-36
4.5.1	I/O Signal Connector (CN1)	4-36
4.5.2	Input Signal Connector (CN11)	4-40
4.5.3	I/O Circuits	4-43

4.6 Serial Command Communications Connector (CN12) . . 4-45

- 4.6.1 Connector Mode 4-45
- 4.6.2 Connector Signal Names 4-45
- 4.6.3 Connection Examples 4-46
- 4.6.4 Wiring Precautions 4-47

4.7 Connecting Safety Function Signals 4-48

- 4.7.1 Pin Arrangement of Safety Function Signals (CN8) . . 4-48
- 4.7.2 I/O Circuits 4-48

4.8 Connecting the Other Connectors 4-50

- 4.8.1 Serial Communications Connector (CN3) 4-50
- 4.8.2 Computer Connector (CN7) 4-50
- 4.8.3 Analog Monitor Connector (CN5) 4-50

4.1 Wiring and Connecting SERVOPACKs

4.1.1 General Precautions



DANGER

- Do not change any wiring while power is being supplied.
There is a risk of electric shock or injury.



WARNING

- Wiring and inspections must be performed only by qualified engineers.
There is a risk of electric shock or product failure.
- Check all wiring and power supplies carefully.
Incorrect wiring or incorrect voltage application to the output circuits may cause short-circuit failures. If a short-circuit failure occurs as a result of any of these causes, the holding brake will not work. This could damage the machine or cause an accident that may result in death or injury.
- Connect the AC and DC power supplies to the specified SERVOPACK terminals.
 - Connect an AC power supply to the L1, L2, and L3 terminals and the L1C and L2C terminals on the SERVOPACK.
 - Connect a DC power supply to the B1/⊕ and ⊖2 terminals and the L1C and L2C terminals on the SERVOPACK.
There is a risk of failure or fire.
- If you use a SERVOPACK with the Dynamic Brake Hardware Option, connect an External Dynamic Brake Resistor that is suitable for the machine and equipment specifications to the specified terminals.
There is a risk of unexpected operation, machine damage, burning, or injury when an emergency stop is performed.

CAUTION

- Wait for at least six minutes after turning OFF the power supply (with a SERVOPACK for a 100-VAC input, wait for at least nine minutes) and then make sure that the CHARGE indicator is not lit before starting wiring or inspection work. Do not touch the power supply terminals while the CHARGE lamp is lit after turning OFF the power supply because high voltage may still remain in the SERVOPACK.
There is a risk of electric shock.
- Observe the precautions and instructions for wiring and trial operation precisely as described in this document.
Failures caused by incorrect wiring or incorrect voltage application in the brake circuit may cause the SERVOPACK to fail, damage the equipment, or cause an accident resulting in death or injury.
- Check the wiring to be sure it has been performed correctly.
Connectors and pin layouts are sometimes different for different models. Always confirm the pin layouts in technical documents for your model before operation.
There is a risk of failure or malfunction.
- Connect wires to power supply terminals and motor connection terminals securely with the specified methods and tightening torque.
Insufficient tightening may cause wires and terminal blocks to generate heat due to faulty contact, possibly resulting in fire.
- Use shielded twisted-pair cables or screened unshielded multi-twisted-pair cables for I/O Signal Cables and Encoder Cables.
- The maximum wiring length is 3 m for I/O Signal Cables, and 50 m for Encoder Cables or Servomotor Main Circuit Cables.
- Observe the following precautions when wiring the SERVOPACK's main circuit terminals.
 - Turn ON the power supply to the SERVOPACK only after all wiring, including the main circuit terminals, has been completed.
 - If a connector is used for the main circuit terminals, remove the main circuit connector from the SERVOPACK before you wire it.
 - Insert only one wire per insertion hole in the main circuit terminals.
 - When you insert a wire, make sure that the conductor wire (e.g., whiskers) does not come into contact with adjacent wires.
- Install molded-case circuit breakers and other safety measures to provide protection against short circuits in external wiring.
There is a risk of fire or failure.

NOTICE

- Whenever possible, use the Cables specified by Yaskawa.
If you use any other cables, confirm the rated current and application environment of your model and use the wiring materials specified by Yaskawa or equivalent materials.
- Securely tighten cable connector screws and lock mechanisms.
Insufficient tightening may result in cable connectors falling off during operation.
- Do not bundle power lines (e.g., the Main Circuit Cable) and low-current lines (e.g., the I/O Signal Cables or Encoder Cables) together or run them through the same duct. If you do not place power lines and low-current lines in separate ducts, separate them by at least 30 cm. If the cables are too close to each other, malfunctions may occur due to noise affecting the low-current lines.
- Install a battery at either the host controller or on the Encoder Cable.
If you install batteries both at the host controller and on the Encoder Cable at the same time, you will create a loop circuit between the batteries, resulting in a risk of damage or burning.
- When connecting a battery, connect the polarity correctly.
There is a risk of battery rupture or encoder failure.



Important

- Use a molded-case circuit breaker or fuse to protect the main circuit. The SERVOPACK connects directly to a commercial power supply; it is not isolated through a transformer or other device. Always use a molded-case circuit breaker or fuse to protect the servo system from accidents involving different power system voltages or other accidents.
- Install an earth leakage breaker. The SERVOPACK does not have a built-in ground fault protective circuit. To configure a safer system, install a ground fault detector against overloads and short-circuiting, or install a ground fault detector combined with a molded-case circuit breaker.
- Do not turn the power supply ON and OFF more than necessary.
 - Do not use the SERVOPACK for applications that require the power supply to turn ON and OFF frequently. Such applications will cause elements in the SERVOPACK to deteriorate.
 - After you have started actual operation, allow at least one hour between turning the power supply ON and OFF (as a guideline).

To ensure safe, stable application of the servo system, observe the following precautions when wiring.

- Use the cables specified by Yaskawa. Design and arrange the system so that each cable is as short as possible.

Refer to the following manual or catalog for information on the specified cables.

📖 AC Servo Drives Σ -7 Series (Catalog No.: KAEP S800001 23)

📖 Σ -7-Series Peripheral Device Selection Manual (Manual No.: SIEP S800001 32)

- The signal cable conductors are as thin as 0.2 mm² or 0.3 mm². Do not subject them to excessive bending stress or tension.

4.1.2 Countermeasures against Noise



Important

The SERVOPACK is designed as an industrial device. It therefore provides no measures to prevent radio interference. The SERVOPACK uses high-speed switching elements in the main circuit. Therefore peripheral devices may be affected by switching noise.

If the equipment is to be used near private houses or if radio interference is a problem, take countermeasures against noise.

The SERVOPACK uses microprocessors. Therefore, it may be affected by switching noise from peripheral devices.

To prevent the noise from the SERVOPACK or the peripheral devices from causing malfunctions of any devices, take the following countermeasures against noise as required.

- Install the input reference device and Noise Filter as close to the SERVOPACK as possible.
- Always install a Surge Absorber for relays, solenoids, and Magnetic Contactor coils.
- Do not place the following cables in the same duct or bundle them together. Also, separate the cables from each other by at least 30 cm.
 - Main Circuit Cables and I/O Signal Cables
 - Main Circuit Cables and Encoder Cables
- Do not share the power supply with an electric welder or electrical discharge machine. If the SERVOPACK is placed near a high-frequency generator, install Noise Filters on the input side on the Main Circuit Power Supply Cable and Control Power Supply Cable even if the same power supply is not shared with the high-frequency generator. Refer to the following section for information on connecting Noise Filters.

 *Noise Filters on page 4-7*

- Implement suitable grounding measures. Refer to the following section for information on grounding measures.

 *4.1.3 Grounding on page 4-9*

Noise Filters

You must attach Noise Filters in appropriate places to protect the SERVOPACK from the adverse effects of noise. The following is an example of wiring for countermeasures against noise.

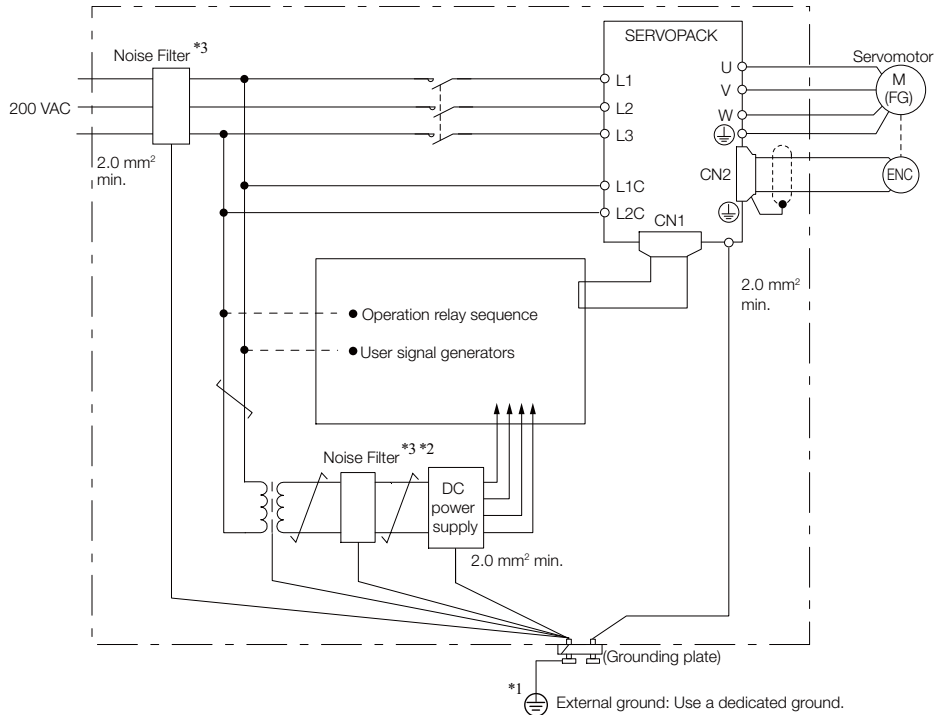

*1. For the ground wire, use a wire with a thickness of at least 2.0 mm² (preferably, flat braided copper wire).

*2. Whenever possible, use twisted-pair wires to wire all connections marked with .

*3. Refer to the following section for precautions when using Noise Filters.

 **Noise Filter Wiring and Connection Precautions** on page 4-8

Noise Filter Wiring and Connection Precautions

Always observe the following precautions when wiring or connecting Noise Filters.

- Separate input lines from output lines. Do not place input lines and output lines in the same duct or bundle them together.

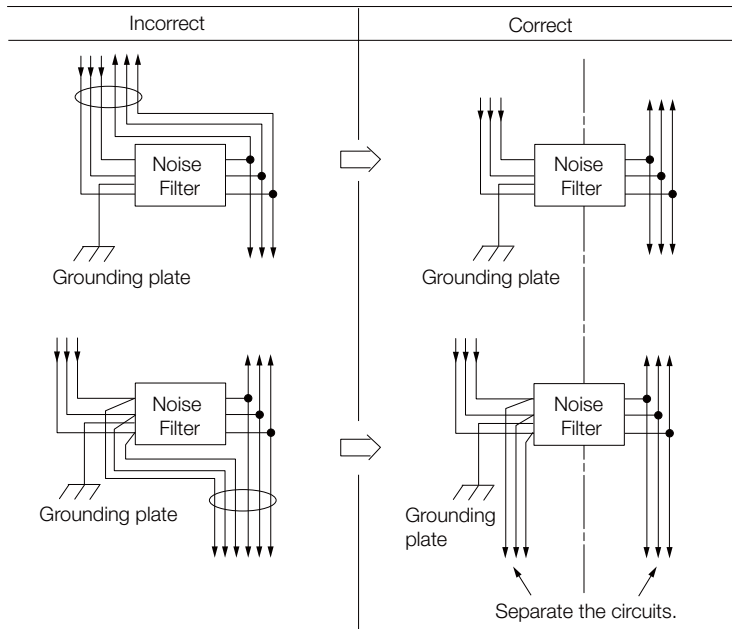

- Separate the Noise Filter ground wire from the output lines. Do not place the Noise Filter ground wire, output lines, and other signal lines in the same duct or bundle them together.

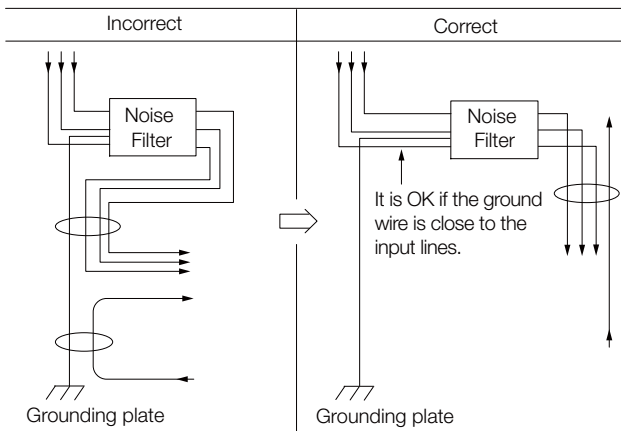

- Connect the Noise Filter ground wire directly to the grounding plate. Do not connect the Noise Filter ground wire to other ground wires.

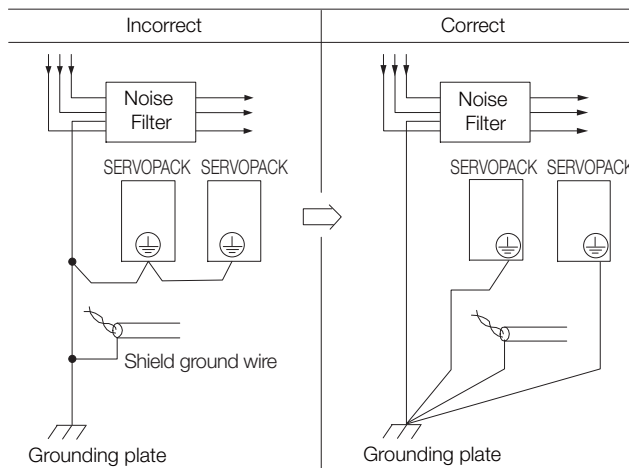

- If a Noise Filter is located inside a control panel, first connect the Noise Filter ground wire and the ground wires from other devices inside the control panel to the grounding plate for the control panel, then ground the plate.

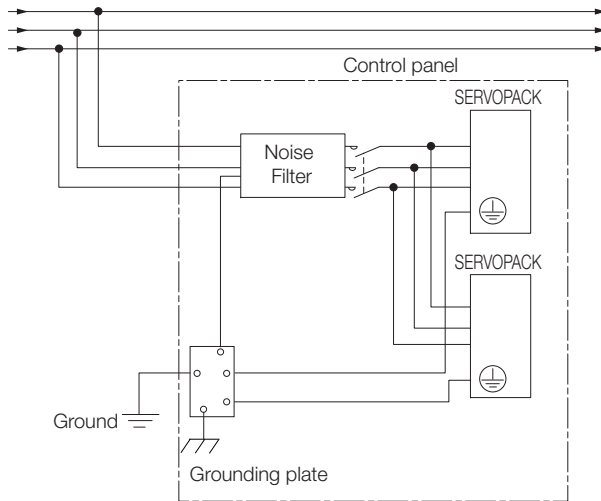

4.1.3 Grounding

Implement grounding measures as described in this section. Implementing suitable grounding measures will also help prevent malfunctions, which can be caused by noise.

Observe the following precautions when wiring the ground cable.

- Ground the SERVOPACK to a resistance of 100 Ω or less.
- Be sure to ground at one point only.
- Ground the Servomotor directly if the Servomotor is insulated from the machine.

Motor Frame Ground or Motor Ground

If you ground the Servomotor through the machine, a current resulting from switching noise can flow from the main circuit of the SERVOPACK through the stray capacitance of the Servomotor. To prevent this, always connect the FG terminal of the Servomotor Main Circuit Cable connected to the Servomotor to the ground terminal (⊕) on the SERVOPACK. Also be sure to ground the ground terminal (⊕).

Always connect the shield wire of the Encoder Cable connected to the Servomotor to the connector case (shell).

Noise on I/O Signal Cables

If noise enters the I/O Signal Cable, connect the shield of the I/O Signal Cable to the connector shell to ground it. If the Servomotor Main Circuit Cable is placed in a metal conduit, ground the conduit and its junction box. For all grounding, ground at one point only.

4.2 Basic Wiring Diagrams

This section provide the basic wiring diagrams. Refer to the reference sections given in the diagrams for details.

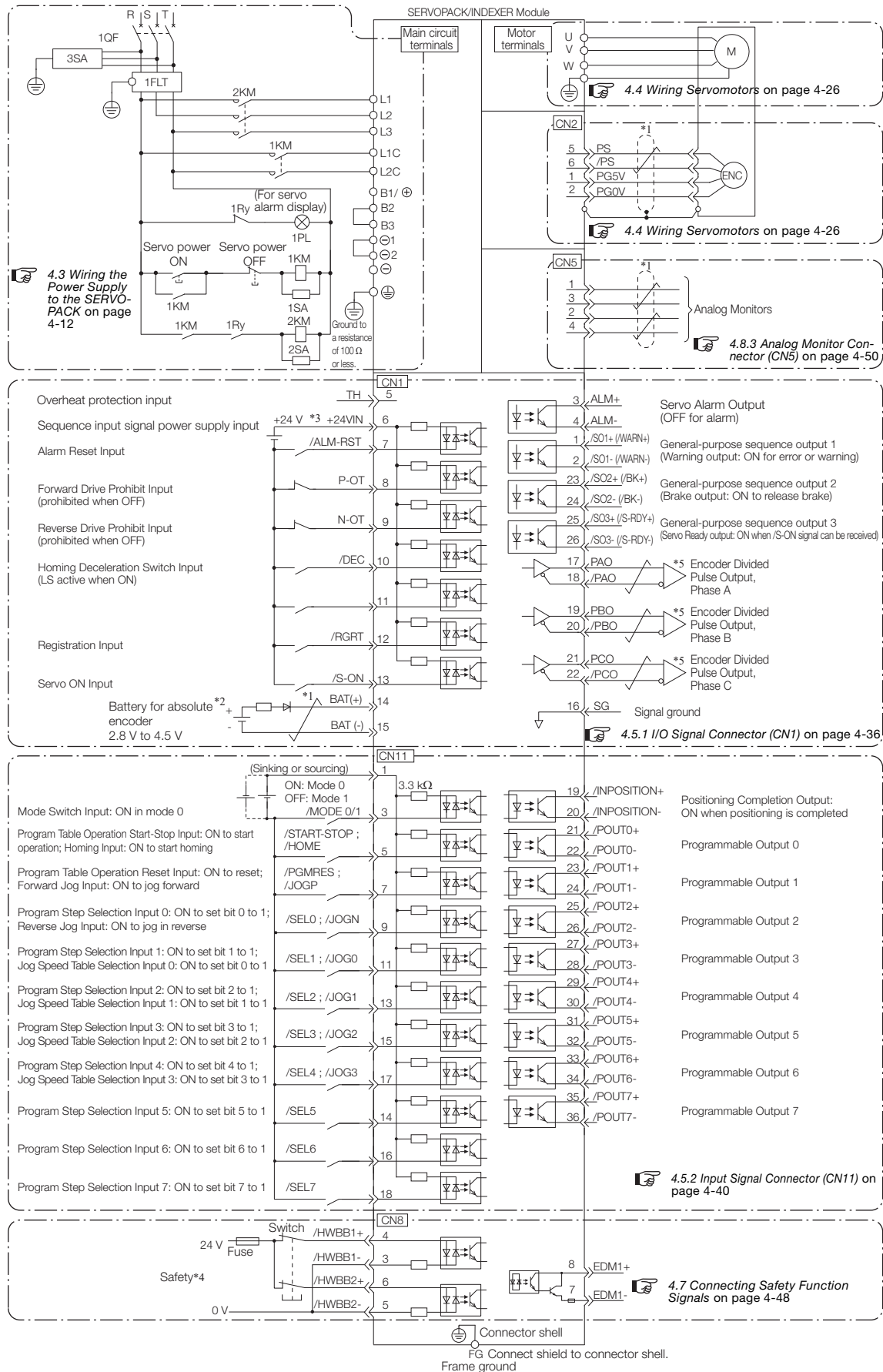

- *1.  represents twisted-pair wires.
- *2. Connect these when using an absolute encoder. If the Encoder Cable with a Battery Case is connected, do not connect a backup battery.
- *3. The 24-VDC power supply is not provided by Yaskawa. Use a 24-VDC power supply with double insulation or reinforced insulation.
- *4. Refer to the following chapter if you use a safety function device.

 **Chapter 11 Safety Functions**

If you do not use the safety function, insert the Safety Jumper Connector (provided as an accessory) into CN8 when you use the SERVOPACK.

- *5. Always use line receivers to receive the output signals.

Note: 1. If you use a 24-V brake, install a separate power supply for the 24-VDC power supply from other power supplies, such as the one for the I/O signals of the CN1 connector. If the power supply is shared, the I/O signals may malfunction.

2. Default settings are given in parentheses.

4.3 Wiring the Power Supply to the SERVOPACK

Refer to the following manual or catalog for information on cables and peripheral devices.

📖 AC Servo Drives Σ -7 Series (Catalog No.: KAEP S800001 23)

📖 Σ -7-Series Peripheral Device Selection Manual (Manual No.: SIEP S800001 32)

4.3.1 Terminal Symbols and Terminal Names



Use the main circuit connector on the SERVOPACK to wire the main circuit power supply and control circuit power supply to the SERVOPACK.

CAUTION



- Wire all connections correctly according to the following table and specified reference information. There is a risk of SERVOPACK failure or fire if incorrect wiring is performed.

The SERVOPACKs have the following four types of main circuit power supply input specifications.

• Three-Phase, 200-VAC Power Supply Input

Terminal Symbols	Terminal Name	Specifications and Reference	
L1, L2, L3	Main circuit power supply input terminals for AC power supply input	Three-phase, 200 VAC to 240 VAC, -15% to +10%, 50 Hz/60 Hz	
L1C, L2C	Control power supply terminals	AC power supply	Single-phase, 200 VAC to 240 VAC, -15% to +10%, 50 Hz/60 Hz
		DC power supply	L1C: 270 VDC to 324 VDC, -15% to +10%, L2C: 0 VDC or L2C: 270 VDC to 324 VDC, -15% to +10%, L1C: 0 VDC
B1/⊕, B2, B3	Regenerative Resistor terminals	 4.3.5 Wiring Regenerative Resistors on page 4-23	
		■ For SGD7S-R70A, -R90A, -1R6A, and -2R8A If the regenerative capacity is insufficient, connect an External Regenerative Resistor between B1/⊕ and B2. The External Regenerative Resistor is not included. Obtain it separately.	
		■ For SGD7S-3R8A, -5R5A, -7R6A, -120A, -180A, -200A, and -330A If the internal regenerative resistor is insufficient, remove the lead or short bar between B2 and B3 and connect an External Regenerative Resistor between B1/⊕ and B2. The External Regenerative Resistor is not included. Obtain it separately.	
		■ For SGD7S-470A, -550A, -590A, and -780A Connect a Regenerative Resistor Unit between B1/⊕ and B2. Obtain a Regenerative Resistor Unit separately. These models do not have a B3 terminal.	
⊖1, ⊖2	DC Reactor terminals for power supply harmonic suppression	 4.3.6 Wiring Reactors for Harmonic Suppression on page 4-25 These terminals are used to connect a DC Reactor for power supply harmonic suppression.	
⊖	-	None. (Do not connect anything to this terminal.)	

- Single-Phase, 200-VAC Power Supply Input

Terminal Symbols	Terminal Name	Specifications and Reference	
L1, L2	Main circuit power supply input terminals for AC power supply input	Single-phase, 200 VAC to 240 VAC, -15% to +10%, 50 Hz/60 Hz	
L1C, L2C	Control power supply terminals	AC power supply	Single-phase, 200 VAC to 240 VAC, -15% to +10%, 50 Hz/60 Hz
		DC power supply	L1C: 270 VDC to 324 VDC, -15% to +10%, L2C: 0 VDC or L2C: 270 VDC to 324 VDC, -15% to +10%, L1C: 0 VDC
B1/⊕, B2, B3	Regenerative Resistor terminals	 4.3.5 Wiring Regenerative Resistors on page 4-23	
		<ul style="list-style-type: none"> ■ For SGD7S-R70A, -R90A, -1R6A, and -2R8A If the regenerative capacity is insufficient, connect an External Regenerative Resistor between B1/⊕ and B2. The External Regenerative Resistor is not included. Obtain it separately. ■ For SGD7S-5R5A and -120AE0A008 If the internal regenerative resistor is insufficient, remove the lead or short bar between B2 and B3 and connect an External Regenerative Resistor between B1/⊕ and B2. The External Regenerative Resistor is not included. Obtain it separately. 	
⊖1, ⊖2	DC Reactor terminals for power supply harmonic suppression	 4.3.6 Wiring Reactors for Harmonic Suppression on page 4-25 These terminals are used to connect a DC Reactor for power supply harmonic suppression.	
L3, ⊖	–	None. (Do not connect anything to these terminals.)	

You can use a single-phase, 200-V power supply input with the following models.

- SGD7S-R70A, -R90A, -1R6A, -2R8A, -5R5A

If you use a single-phase, 200-VAC power supply input for the SERVOPACK's main circuit power supply, set parameter Pn00B to n.□1□□ (Use a three-phase power supply input as a single-phase power supply input). Refer to the following section for details.

 **5.2.2 Single-phase AC Power Supply Input/Three-phase AC Power Supply Input Setting on page 5-13**

Information You do not need to change the setting of Pn00B to n.□1□□ (Use a three-phase power supply input as a single-phase power supply input) for a SERVOPACK with a single-phase 200-VAC power supply input (model number: SGD7S-120AE0A008).

- DC Power Supply Input

Terminal Symbols	Terminal Name	Specifications and Reference	
L1C, L2C	Control power supply terminals	AC power supply	Single-phase, 200 VAC to 240 VAC, -15% to +10%, 50 Hz/60 Hz
		DC power supply	L1C: 270 VDC to 324 VDC, -15% to +10%, L2C: 0 VDC or L2C: 270 VDC to 324 VDC, -15% to +10%, L1C: 0 VDC
B1/⊕	Main circuit power supply input terminals for DC power supply input	270 VDC to 324 VDC, -15% to +10%	
⊖2		0 VDC	
L1, L2, L3, B2, B3, ⊖1, ⊖	–	None. (Do not connect anything to these terminals.) Note: 1. SGD7S-470A to 780A do not have a B3 terminal. 2. SGD7S-330A to 780A do not have a ⊖ terminal.	

If you use a DC power supply input to the SERVOPACK, make sure to set parameter Pn00E to n.□□□1 (DC power supply input supported) before inputting the power supply. Refer to the following section for details.

 **5.2.1 AC Power Supply Input/DC Power Supply Input Setting on page 5-12**

4.3 Wiring the Power Supply to the SERVOPACK

4.3.2 Wiring Procedure for Main Circuit Connector

• Single-Phase, 100-VAC Power Supply Input

Terminal Symbols	Terminal Name	Specifications and Reference
L1, L2	Main circuit power supply input terminals for AC power supply input	Single-phase, 100 VAC to 120 VAC, -15% to +10%, 50 Hz/60 Hz
L1C, L2C	Control power supply terminals	Single-phase, 100 VAC to 120 VAC, -15% to +10%, 50 Hz/60 Hz
B1, B2	Regenerative Resistor terminals	 4.3.5 Wiring Regenerative Resistors on page 4-23 If the regenerative capacity is insufficient, connect an External Regenerative Resistor between B1/⊕ and B2. The External Regenerative Resistor is not included. Obtain it separately.

You can use a single-phase, 100-VAC power supply input with the following models.

- SGD7S-R70F, -R90F, -2R1F, and -2R8F

4.3.2 Wiring Procedure for Main Circuit Connector

• Required Items

Required Item	Remarks
Spring Opener or Flat-blade Screwdriver	<ul style="list-style-type: none"> • Spring Opener SERVOPACK accessory (You can also use model 1981045-1 from Tyco Electronics Japan G.K.) • Flat-blade screwdriver Commercially available screwdriver with tip width of 3.0 mm to 3.5 mm

1. Remove the main circuit connector and motor connector from the SERVOPACK.

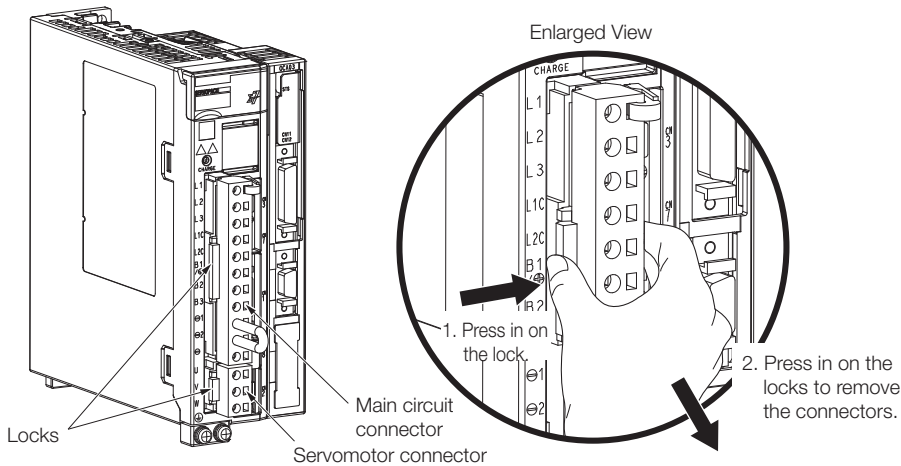

2. Remove the sheath from the wire to connect.

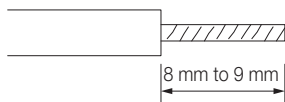

- Open the wire insertion hole on the terminal connector with the tool. There are the following two ways to open the insertion hole. Use either method.

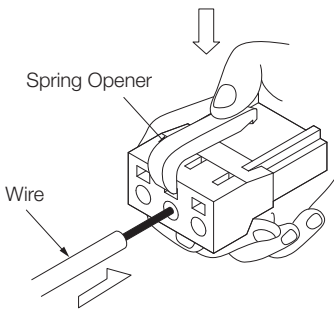
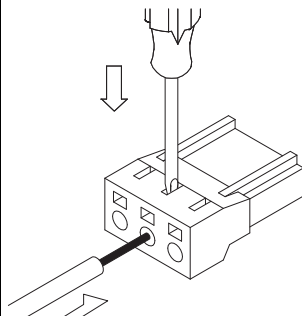
①Using a Spring Opener	②Using a Flat-blade Screwdriver
<p>Open the insertion hole with the Spring Opener as shown in the figure.</p> 	<p>Firmly insert a flat-blade screwdriver into the screwdriver insertion hole to open the wire insertion hole.</p> 

- Insert the conductor into the wire insertion hole. Then, remove the Spring Opener or flat-blade screwdriver.
- Make all other connections in the same way.
- When you have completed wiring, attach the connectors to the SERVOPACK.

4.3.3 Power ON Sequence

Consider the following points when you design the power ON sequence.

- The ALM (Servo Alarm) signal is output for up to five seconds when the control power supply is turned ON. Take this into consideration when you design the power ON sequence, and turn ON the main circuit power supply to the SERVOPACK when the ALM signal is OFF (alarm cleared).

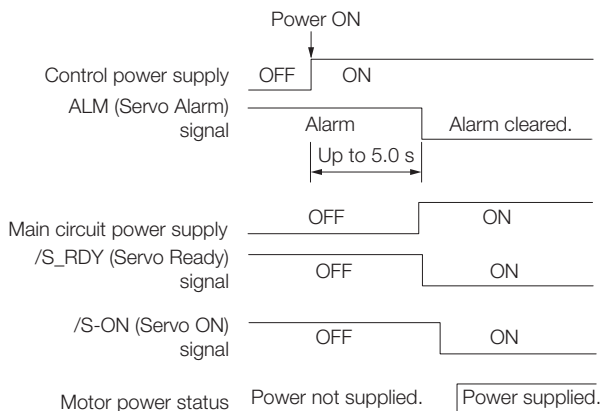

Information

If the servo ON state cannot be achieved by turning ON the /S_ON signal, the /S_RDY signal is not ON. Check the status of the /S_RDY signal. Refer to the following section for details.
 */S-RDY (Servo Ready) Signal* on page 6-8

4.3.3 Power ON Sequence

- If you use a DC power supply input with any of the following SERVOPACKs, use the power ON sequence shown below: SGD7S-330A, -470A, -550A, -590A, or -780A.

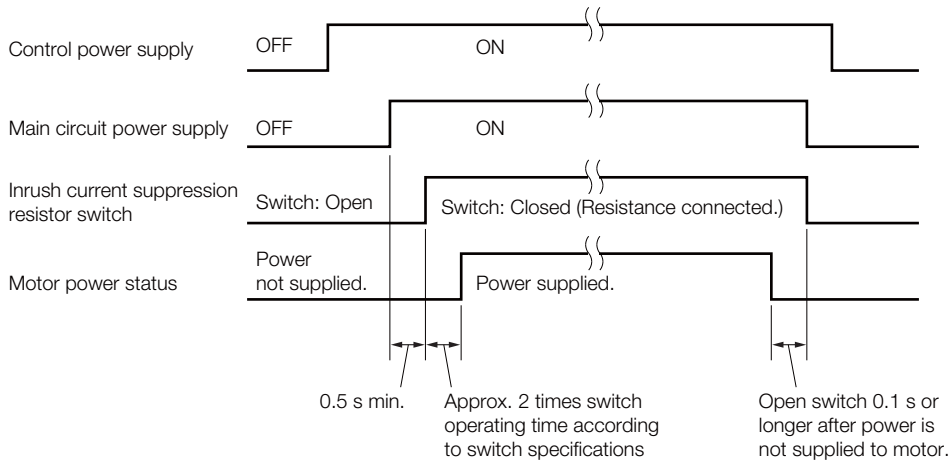

- Design the power ON sequence so that main circuit power supply is turned OFF when an ALM (Servo Alarm) signal is output.
- Make sure that the power supply specifications of all parts are suitable for the input power supply.
- Allow at least 1 s after the power supply is turned OFF before you turn it ON again.



Important Turn ON the control power supply before the main circuit power supply or turn ON the control power supply and the main circuit power supply at the same time. Turn OFF the main circuit power supply first, and then turn OFF the control power supply.



WARNING

- Even after you turn OFF the power supply, a high residual voltage may still remain in the SERVOPACK. To prevent electric shock, do not touch the power supply terminals after you turn OFF the power. When the voltage is discharged, the CHARGE indicator will turn OFF. Make sure the CHARGE indicator is OFF before you start wiring or inspection work.

4.3.4 Power Supply Wiring Diagrams

Using Only One SERVOPACK

- Wiring Example for Three-Phase, 200-VAC Power Supply Input: SGD7S-R70A, -R90A, -1R6A, -2R8A, -3R8A, -5R5A, -7R6A, -120A, -180A, -200A, and -330A

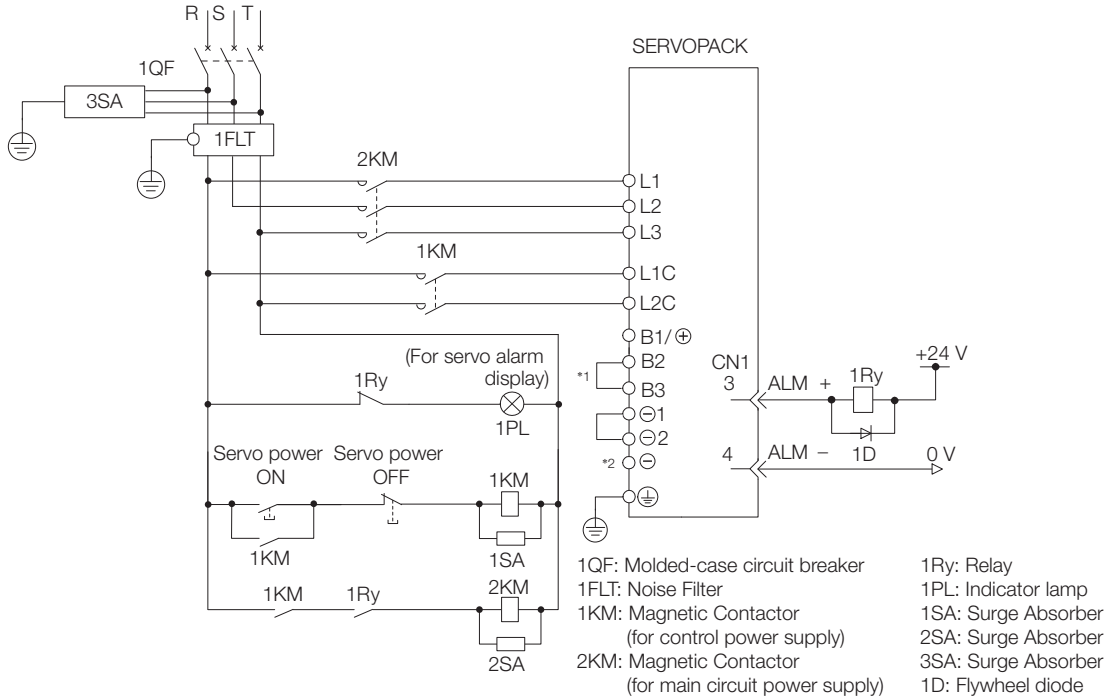

*1. You do not have to connect B2 and B3 for the following models: SGD7S-R70A, SGD7S-R90A, SGD7S-1R6A, and SGD7S-2R8A. Do not connect them.

*2. A SGD7S-330A SERVOPACK does not have a - terminal.

- Wiring Example for Three-Phase, 200-VAC Power Supply Input: SGD7S-470A, -550A, -590A, and -780A

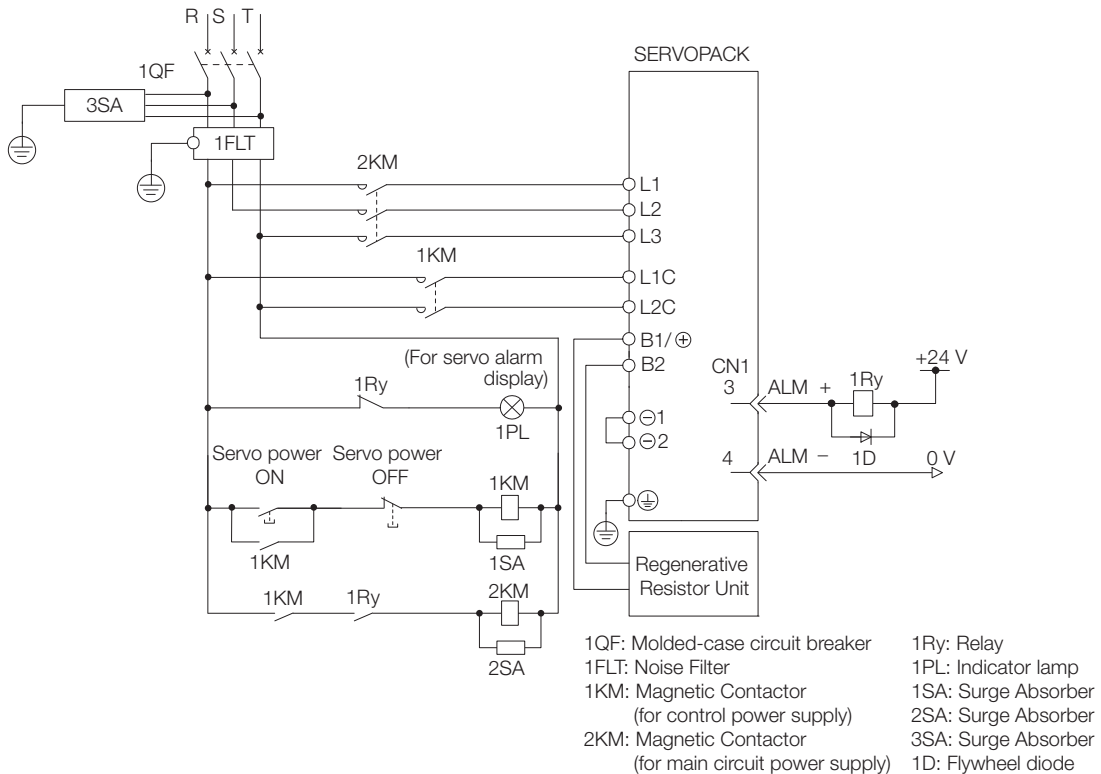

4.3 Wiring the Power Supply to the SERVOPACK

4.3.4 Power Supply Wiring Diagrams

- Wiring Example for Single-Phase, 200-VAC Power Supply Input

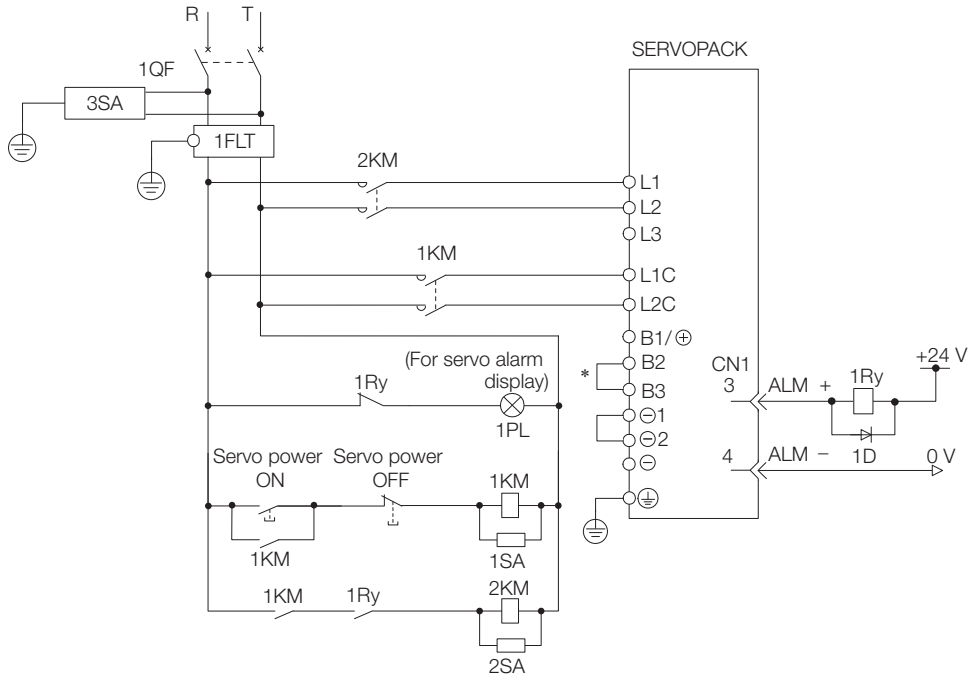

- | | |
|--|---------------------|
| 1QF: Molded-case circuit breaker | 1Ry: Relay |
| 1FLT: Noise Filter | 1PL: Indicator lamp |
| 1KM: Magnetic Contactor
(for control power supply) | 1SA: Surge Absorber |
| 2KM: Magnetic Contactor
(for main circuit power supply) | 2SA: Surge Absorber |
| | 3SA: Surge Absorber |
| | 1D: Flywheel diode |

* You do not have to connect B2 and B3 for the following models: SGD7S-R70A, SGD7S-R90A, SGD7S-1R6A, and SGD7S-2R8A. Do not connect them.

- Wiring Example for DC Power Supply Input: SGD7S-R70A, -R90A, -1R6A, -2R8A, -3R8A, -5R5A, -7R6A, -120A, -180A, and -200A

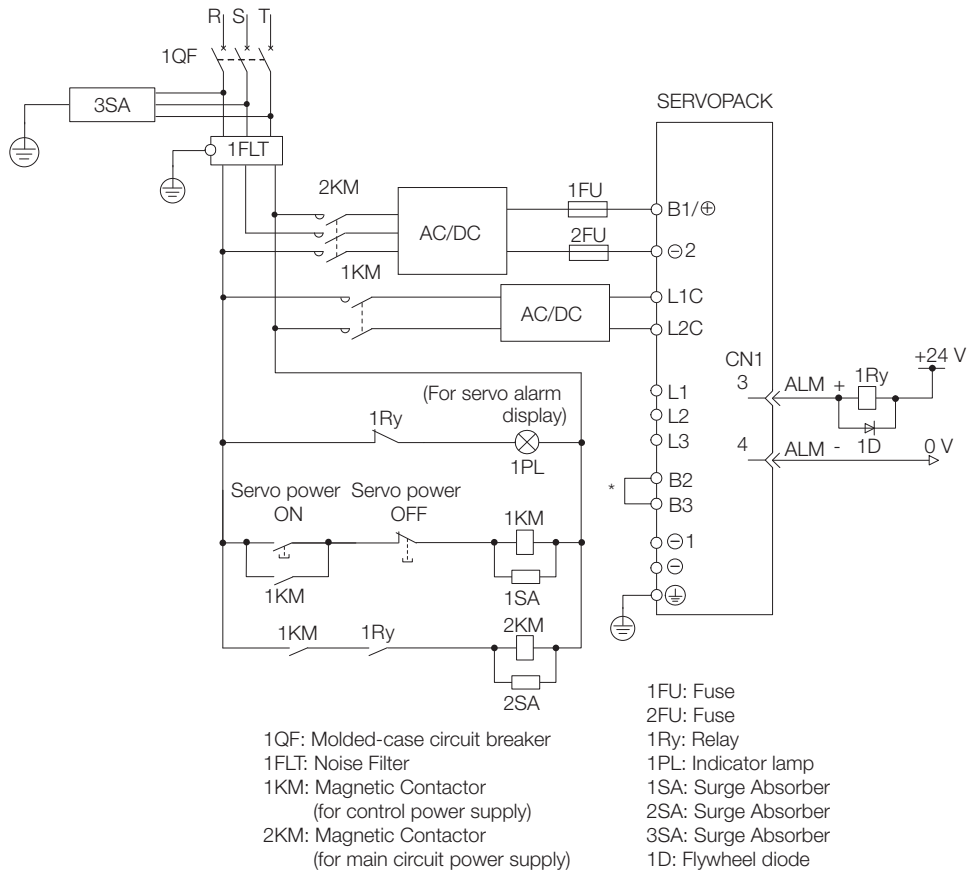

* You do not have to connect B2 and B3 for the following models: SGD7S-R70A, SGD7S-R90A, SGD7S-1R6A, and SGD7S-2R8A. Do not connect them.

4.3 Wiring the Power Supply to the SERVOPACK

4.3.4 Power Supply Wiring Diagrams

- Wiring Example for DC Power Supply Input: SGD7S-330A, -470A, -550A, -590A, and -780A

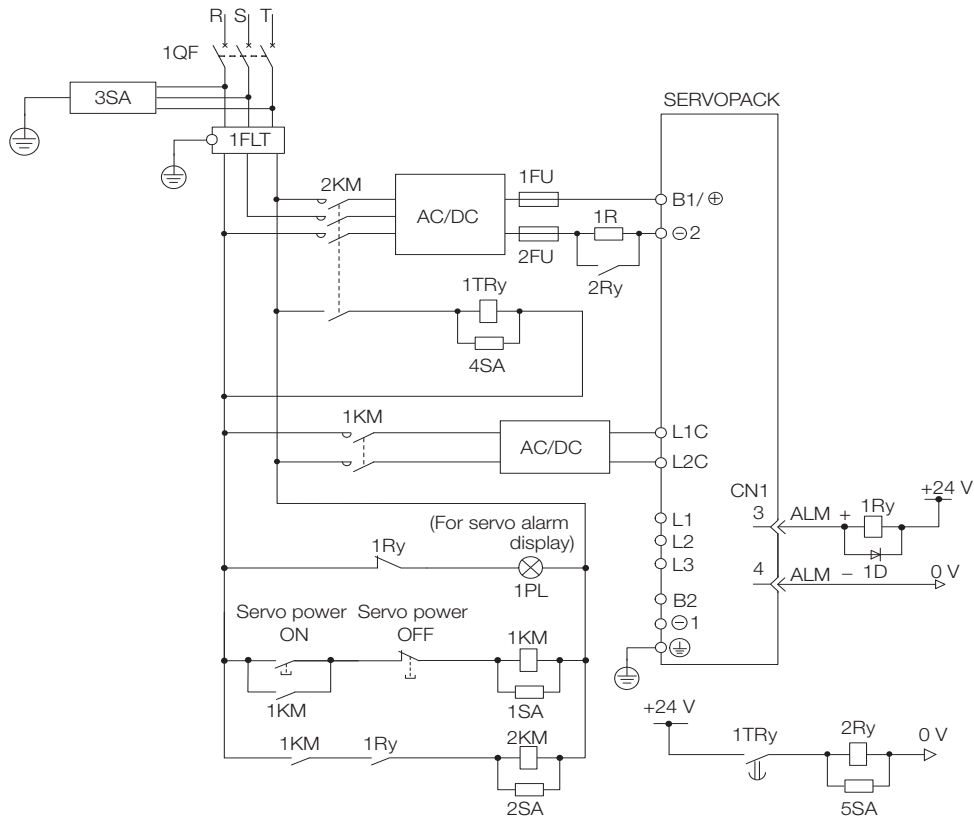

- 1QF: Molded-case circuit breaker
- 1FLT: Noise Filter
- 1KM: Magnetic Contactor (for control power supply)
- 2KM: Magnetic Contactor (for main circuit power supply, auxiliary contact)
- 1FU: Fuse, positive side
- 2FU: Fuse, negative side
- 1Ry: Relay
- 2Ry: Relay (for inrush current suppression resistor switch)
- 1TRy: Timer relay
- 1PL: Indicator lamp

- 1SA: Surge Absorber
- 2SA: Surge Absorber
- 3SA: Surge Absorber
- 4SA: Surge Absorber
- 5SA: Surge Absorber
- 1D: Flywheel diode
- 1R: External inrush current suppression resistor

- Wiring Example for Single-Phase, 100-VAC Power Supply Input: SGD7S-R70F, -R90F, -2R1F, or -2R8F

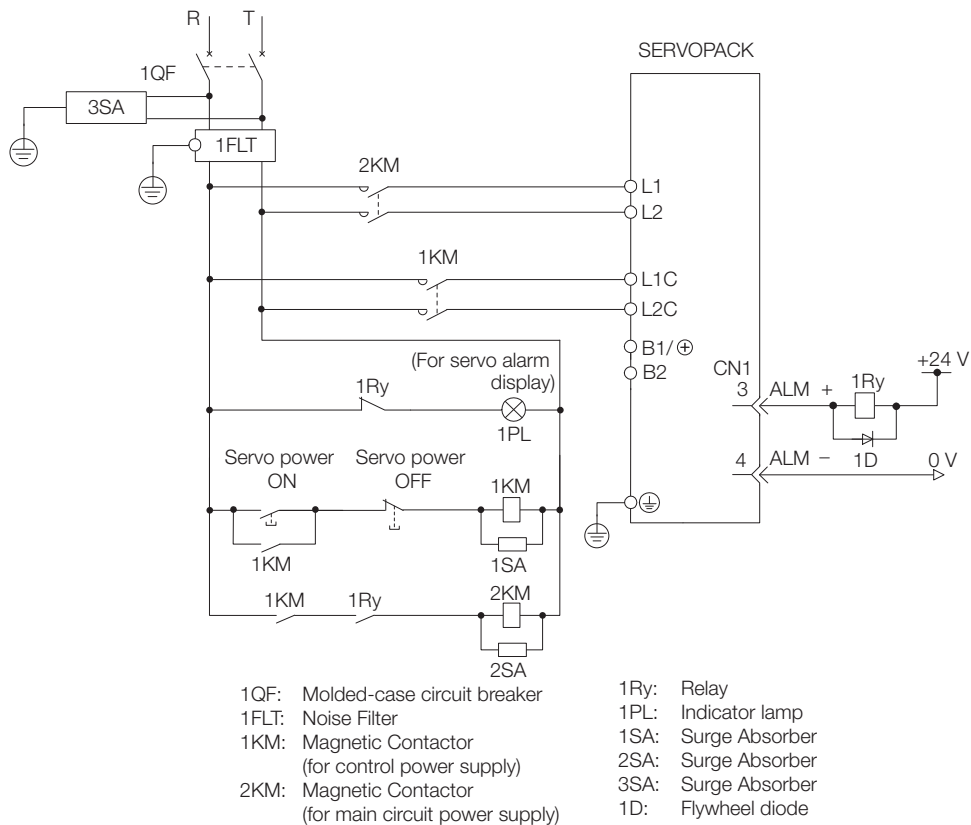

Using More Than One SERVOPACK

Connect the ALM (Servo Alarm) output for these SERVOPACKs in series to operate the alarm detection relay (1RY).

When a SERVOPACK alarm is activated, the ALM output signal transistor turns OFF.

The following diagram shows the wiring to stop all of the Servomotors when there is an alarm for any one SERVOPACK.

More than one SERVOPACK can share a single Noise Filter. However, always select a Noise Filter that has a large enough capacity to handle the total power supply capacity of all the SERVOPACKs. Be sure to consider the load conditions.

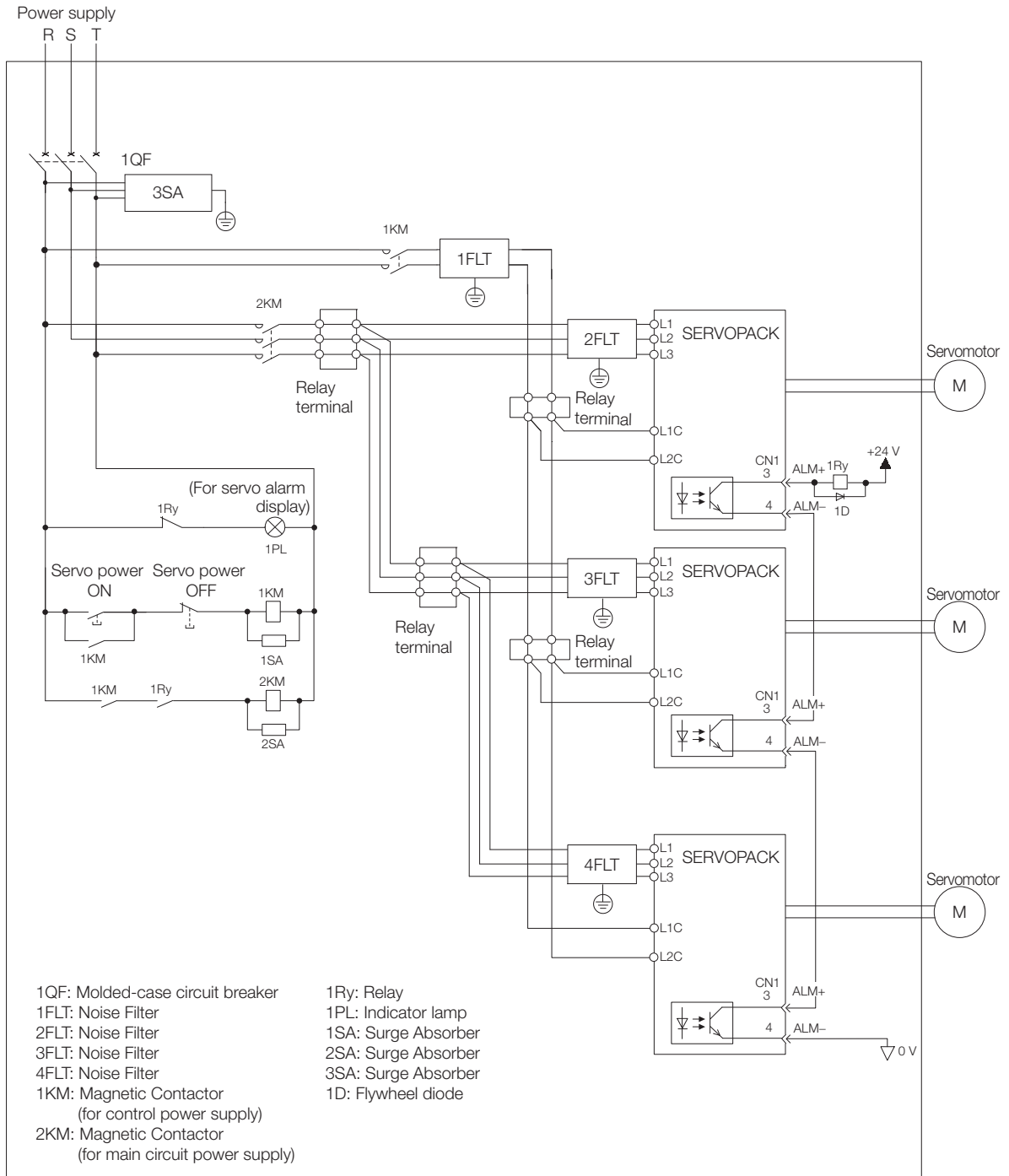

To comply with UL/cUL standards, you must install a branch circuit protective device at the power supply input section to each SERVOPACK. Refer to the following manual for details.

Σ-7-Series Σ-7S/Σ-7W/Σ-7C SERVOPACK Safety Precautions (Manual No.:TOMP C710828 00)

4.3.5 Wiring Regenerative Resistors

This section describes how to connect External Regenerative Resistors.

Refer to the following manual to select the capacity of a Regenerative Resistor.

📖 Σ -7-Series Peripheral Device Selection Manual (Manual No.: SIEP S800001 32)



WARNING

- Be sure to wire Regenerative Resistors correctly. Do not connect B1/⊕ and B2. Doing so may result in fire or damage to the Regenerative Resistor or SERVOPACK.

Connecting Regenerative Resistors

- ◆ SERVOPACK Models SGD7S-R70A, -R90A, -1R6A, -2R8A, -R70F, -R90F, -2R1F, and -2R8F

1. Connect the External Regenerative Resistor between the B1/⊕ and B2 terminals on the SERVOPACK.

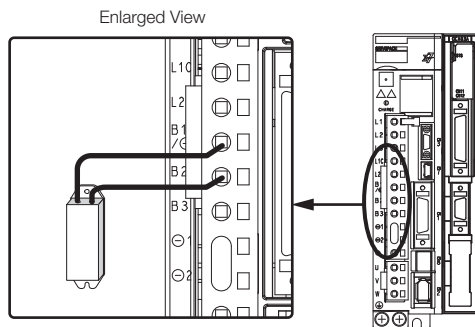

2. Set Pn600 (Regenerative Resistor Capacity) and Pn603 (Regenerative Resistor Resistance).

Refer to the following section for details on the settings.

📖 5.17 Setting the Regenerative Resistor Capacity on page 5-54

- ◆ SERVOPACK Models SGD7S-3R8A, -5R5A, -7R6A, -120A, -180A, -200A, and -330A

1. Remove the lead from between the B2 and B3 terminals on the SERVOPACK.

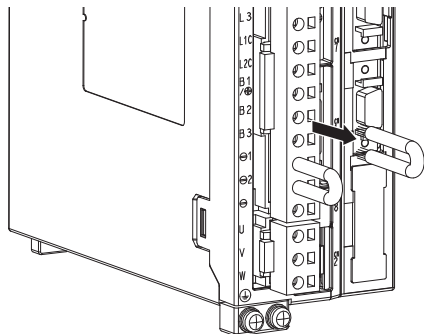

2. Connect the External Regenerative Resistor between the B1/⊕ and B2 terminals.

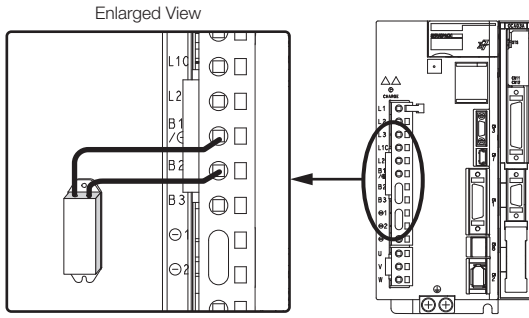

3. Set Pn600 (Regenerative Resistor Capacity) and Pn603 (Regenerative Resistor Resistance). Refer to the following section for details on the settings.

📖 5.17 Setting the Regenerative Resistor Capacity on page 5-54

◆ SERVOPACK Models SGD7S-470A, -550A, -590A, and -780A

1. Connect the R1 and R2 terminals on the Regenerative Resistor Unit to the B1/⊕ and B2 terminals on the SERVOPACK.

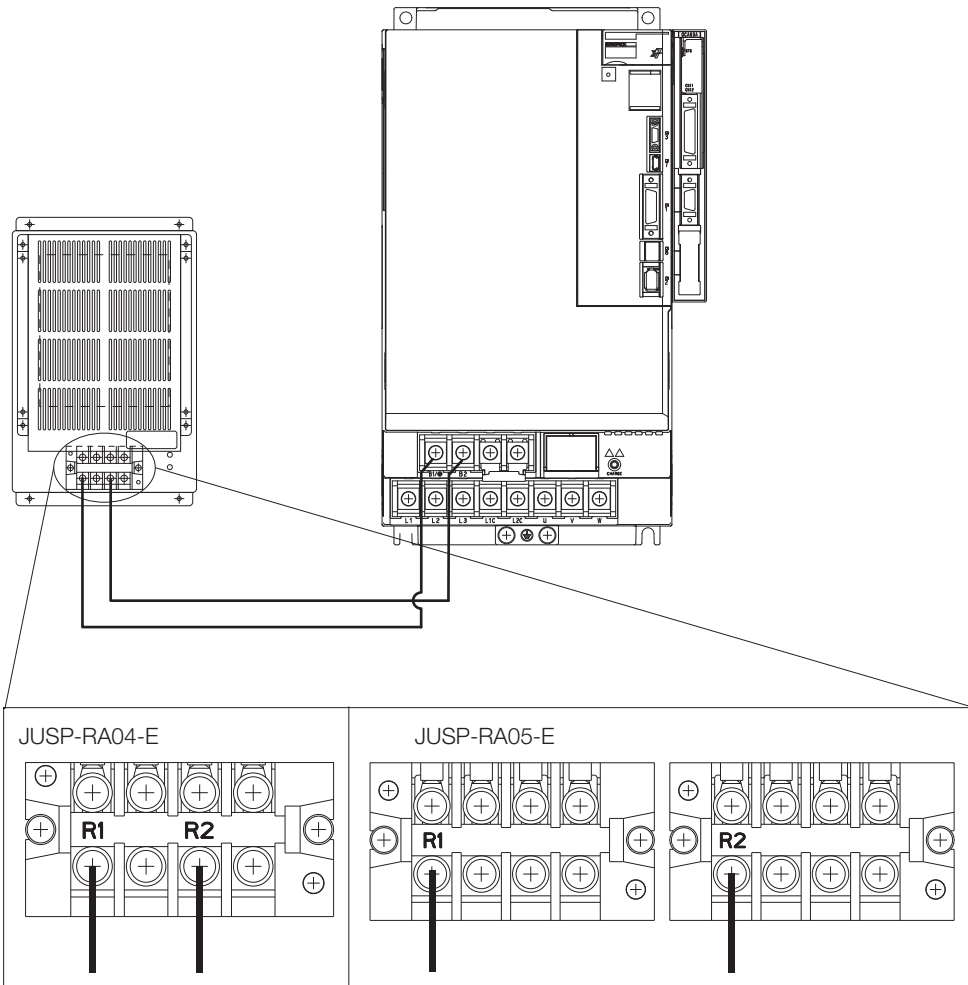

2. Set Pn600 (Regenerative Resistor Capacity) and Pn603 (Regenerative Resistor Resistance) as required.

- When using the Yaskawa-recommended Regenerative Resistor Unit, use the default settings for Pn600 and Pn603.
- If you use any other external regenerative resistor, set Pn600 and Pn603 according to the specifications of the regenerative resistor.

Refer to the following section for details on the settings.

 5.17 *Setting the Regenerative Resistor Capacity* on page 5-54

4.3.6 Wiring Reactors for Harmonic Suppression

You can connect a reactor for harmonic suppression to the SERVOPACK when power supply harmonic suppression is required. Refer to the following manual for details on reactors for harmonic suppression.

 Σ -7-Series Peripheral Device Selection Manual (Manual No.: SIEP S800001 32)

Refer to the following figures to connect reactors.

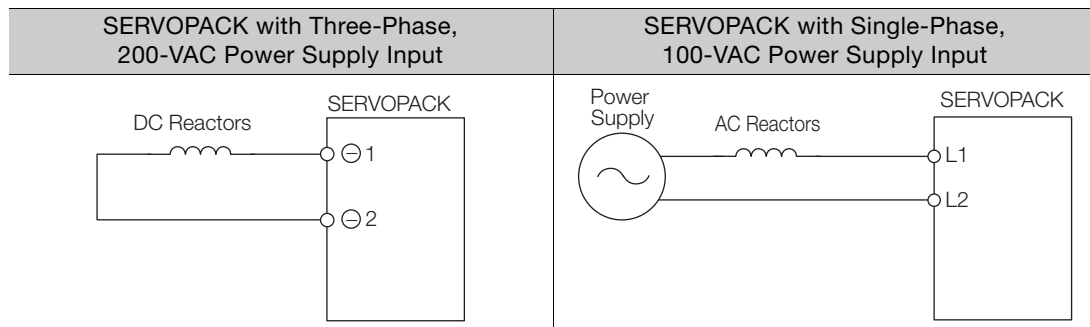

Note: 1. Connection terminals \ominus 1 and \ominus 2 for a DC Reactor are connected when the SERVOPACK is shipped. Remove the lead wire and connect a DC Reactor.



2. Reactors are optional products. (Purchase them separately.)

3. You cannot connect a DC Reactor to a SERVOPACK with a single-phase, 100-VAC power supply input.

4.4 Wiring Servomotors

4.4.1 Terminal Symbols and Terminal Names

The SERVOPACK terminals or connectors that are required to connect the SERVOPACK to a Servomotor are given below.

Terminal/Connector Symbols	Terminal/Connector Name	Remarks
U, V, and W	Servomotor terminals	Refer to the following section for the wiring procedure.  4.3.2 Wiring Procedure for Main Circuit Connector on page 4-14
	Ground terminal	–
CN2	Encoder connector	–

4.4.2 Pin Arrangement of Encoder Connector (CN2)

- When Using a Rotary Servomotor

Pin No.	Signal	Function
1	PG5V	Encoder power supply +5 V
2	PG0V	Encoder power supply 0 V
3	BAT (+)*	Battery for absolute encoder (+)
4	BAT (-)*	Battery for absolute encoder (-)
5	PS	Serial data (+)
6	/PS	Serial data (-)
Shell	Shield	–

* No wiring is required for an incremental encoder or a batteryless absolute encoder.

- When Using a Direct Drive Servomotor

Pin No.	Signal	Function
1	PG5V	Encoder power supply +5 V
2	PG0V	Encoder power supply 0 V
3	–	– (Do not use.)
4	–	– (Do not use.)
5	PS	Serial data (+)
6	/PS	Serial data (-)
Shell	Shield	–

- When Using a Linear Servomotor

Pin No.	Signal	Function
1	PG5V	Linear encoder power supply +5 V
2	PG0V	Linear encoder power supply 0 V
3	–	– (Do not use.)
4	–	– (Do not use.)
5	PS	Serial data (+)
6	/PS	Serial data (-)
Shell	Shield	–

4.4.3 Wiring the SERVOPACK to the Encoder

When Using an Absolute Encoder

If you use an absolute encoder, use an Encoder Cable with a JUSP-BA01-E Battery Case or install a battery on the host controller.

Refer to the following section for the battery replacement procedure.

15.1.3 Replacing the Battery on page 15-3

- Wiring Example When Using an Encoder Cable with a Battery Case

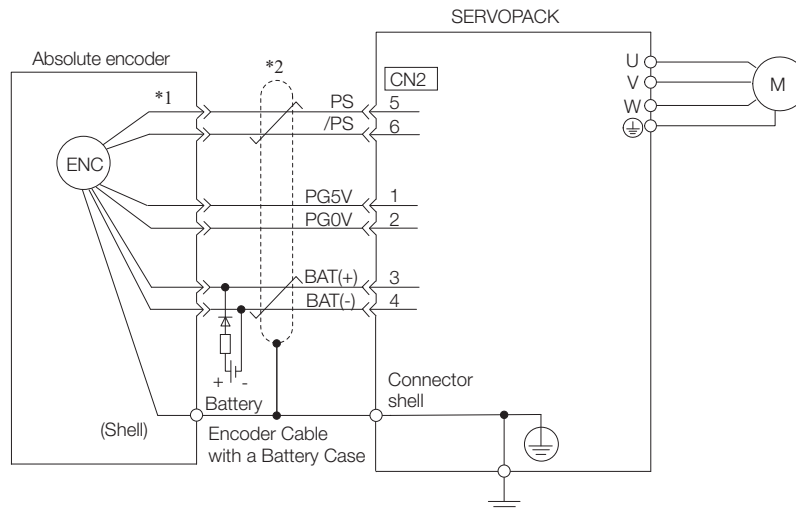

*1. The absolute encoder pin numbers for wiring the connector depend on the Servomotor that you use.

*2. represents a shielded twisted-pair cable.

- Wiring Example When Installing a Battery on the Host Controller

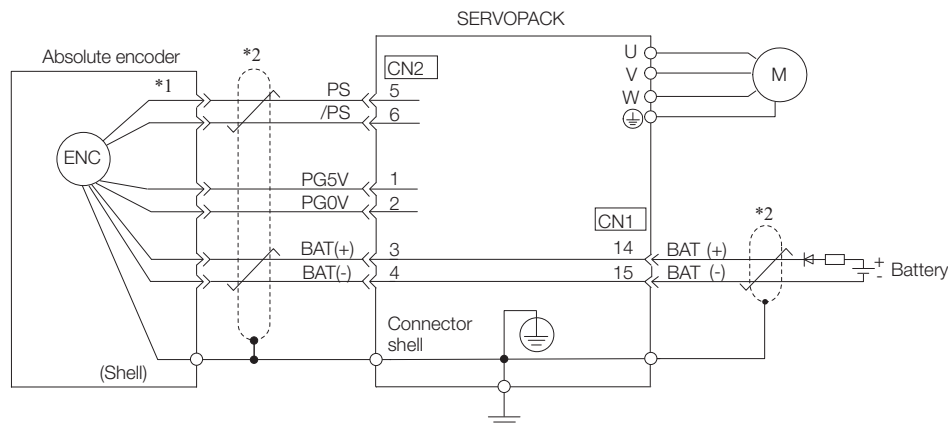

*1. The absolute encoder pin numbers for wiring the connector depend on the Servomotor that you use.

*2. represents a shielded twisted-pair cable.



Important

- When Installing a Battery on the Encoder Cable
Use the Encoder Cable with a Battery Case that is specified by Yaskawa. Refer to the following manual for details.
 Σ -7-Series Peripheral Device Selection Manual (Manual No.: SIEP S800001 32)
- When Installing a Battery on the Host Controller
Insert a diode near the battery to prevent reverse current flow.

Circuit Example

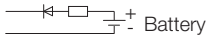

Required Component Specifications

- Schottky Diode
Reverse Voltage: $V_r \geq 40\text{ V}$
Forward Voltage: $V_f \leq 0.37\text{ V}$
Reverse current: $I_r \leq 5\ \mu\text{A}$
Junction temperature: $T_j \geq 125^\circ\text{C}$
- Resistor
Resistance: $22\ \Omega$
Tolerance: $\pm 5\%$ max.
Rated power: 0.25 W min.

When Using an Incremental Encoder or Batteryless Absolute Encoder

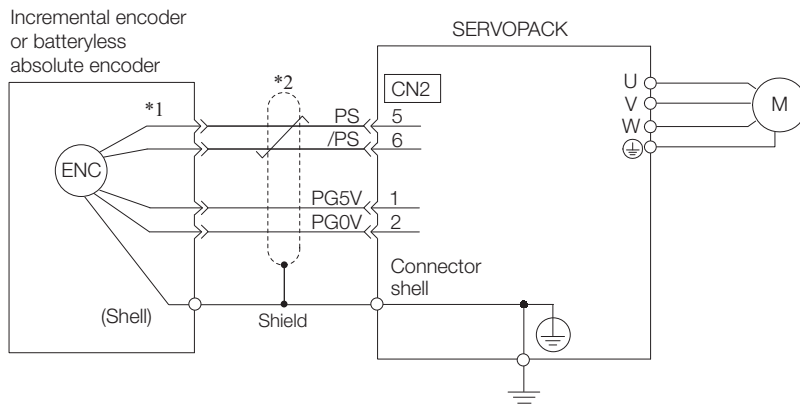

*1. The encoder pin numbers for wiring the connector depend on the Servomotor that you use.

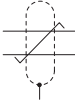
*2.  represents a shielded twisted-pair cable.

When Using an Absolute Linear Encoder

The wiring depends on the manufacturer of the linear encoder.

◆ Connections to Linear Encoder from Dr. JOHANNES HEIDENHAIN GmbH

■ LIC4100 Series, LIC2100 Series, LC115, and LC415

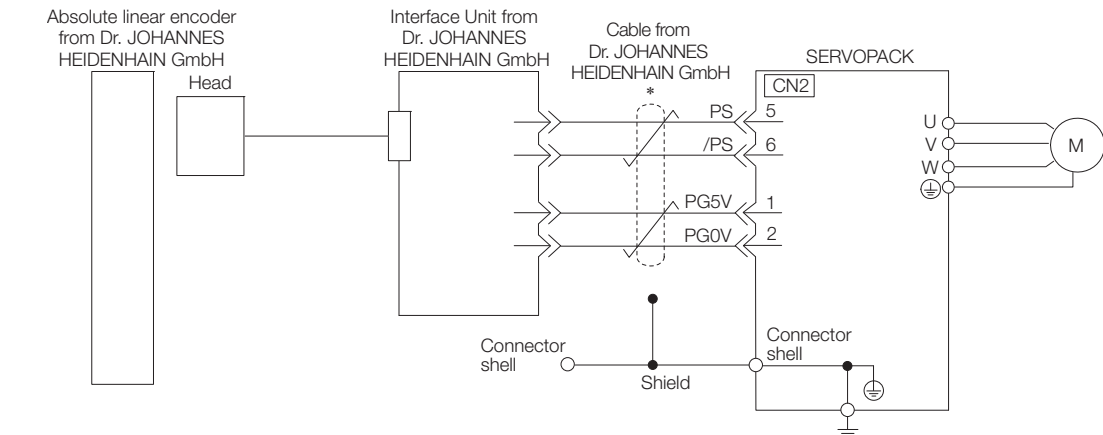

*  represents a shielded twisted-pair cable.

Information Sales of the interface unit EIB3391Y with the LIC4100 and LIC2100 series have ended due to the release of the LIC4190, LIC3190, and LIC2190 series.

■ LIC4190, LIC3190, and LIC2190 Series

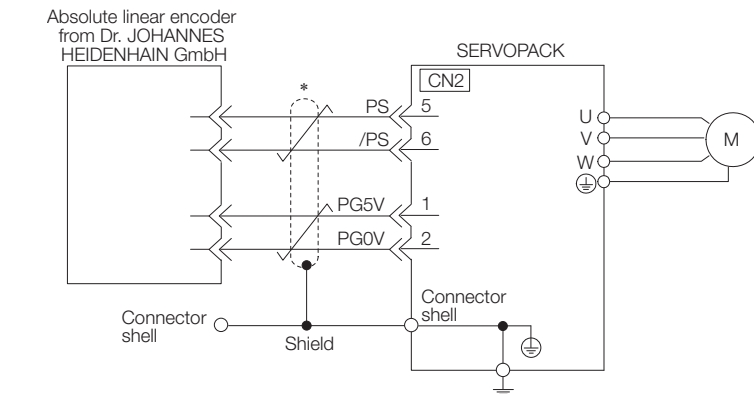

*  represents a shielded twisted-pair cable.

◆ Connections to Linear Encoder from RSF Elektronik GmbH

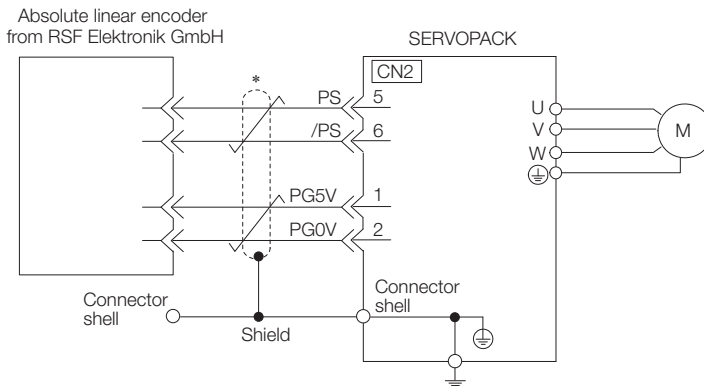

*  represents a shielded twisted-pair cable.

◆ Connections to Linear Encoder from Mitutoyo Corporation

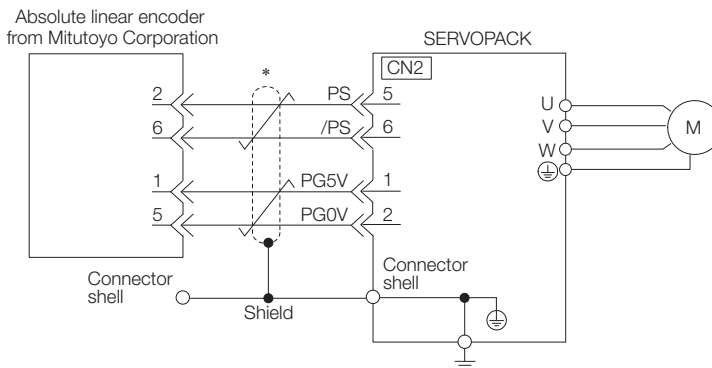

*  represents a shielded twisted-pair cable.

◆ Connections to Absolute Linear Encoder from Renishaw PLC

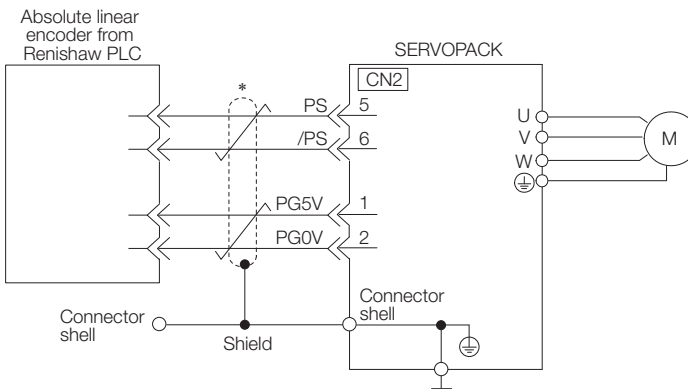

*  represents a shielded twisted-pair cable.

◆ Connections to Linear Encoder from RLS d.o.o.

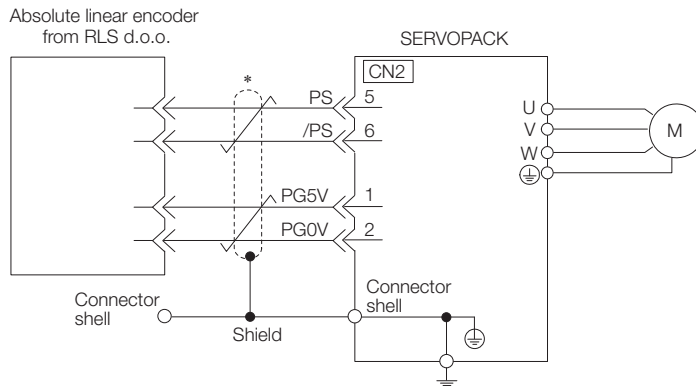

*  represents a shielded twisted-pair cable.

◆ Connections to Absolute Linear Encoder from Magnescale Co., Ltd.

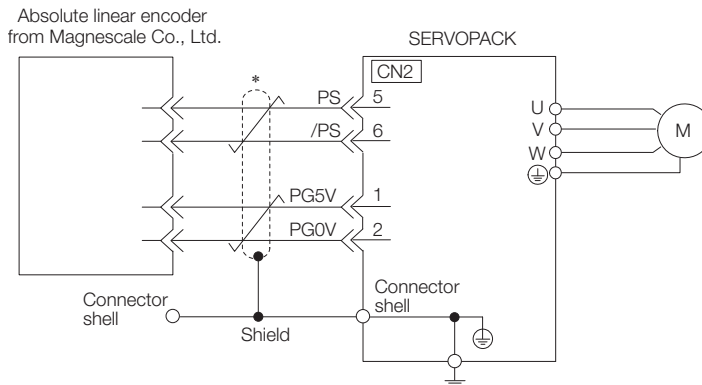

*  represents a shielded twisted-pair cable.

◆ Connections to Absolute Linear Encoder from Fagor Automation S. Coop.

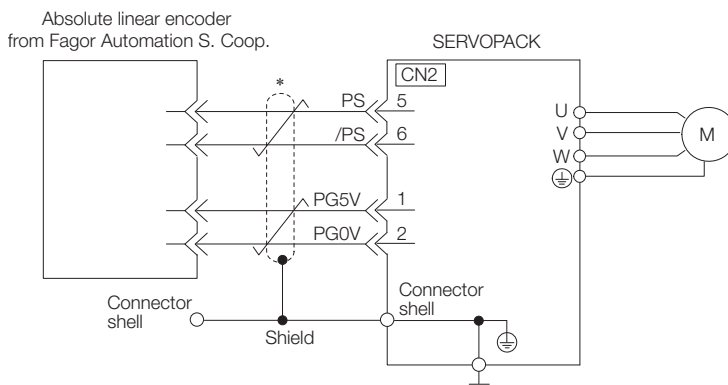

*  represents a shielded twisted-pair cable.

◆ Connections to Absolute Linear Encoder from Canon Precision Inc.

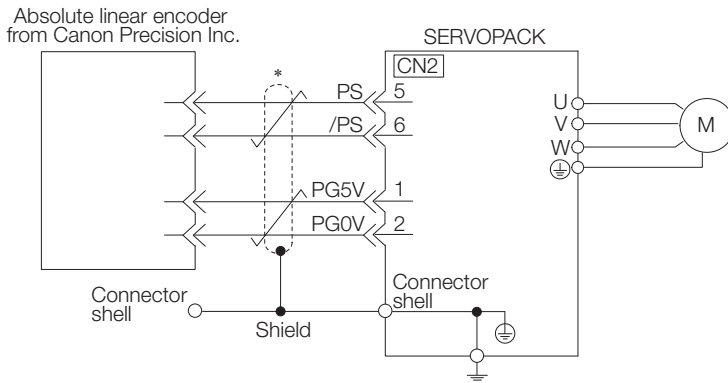



*  represents a shielded twisted-pair cable.

When Using an Incremental Linear Encoder

The wiring depends on the manufacturer of the linear encoder.

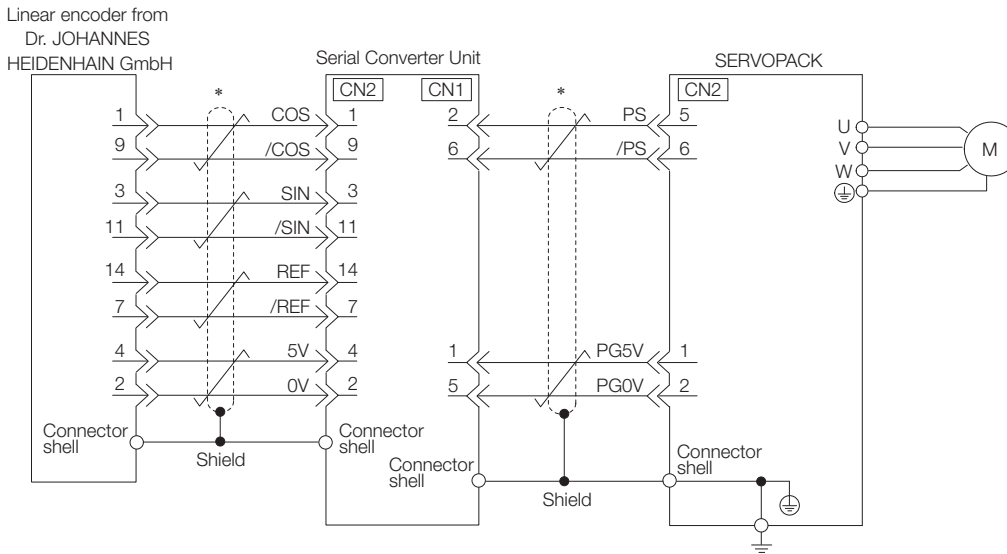
◆ Connections to Linear Encoder from Dr. JOHANNES HEIDENHAIN GmbH



*  represents a shielded twisted-pair cable.

◆ Connections to Linear Encoder from Renishaw PLC

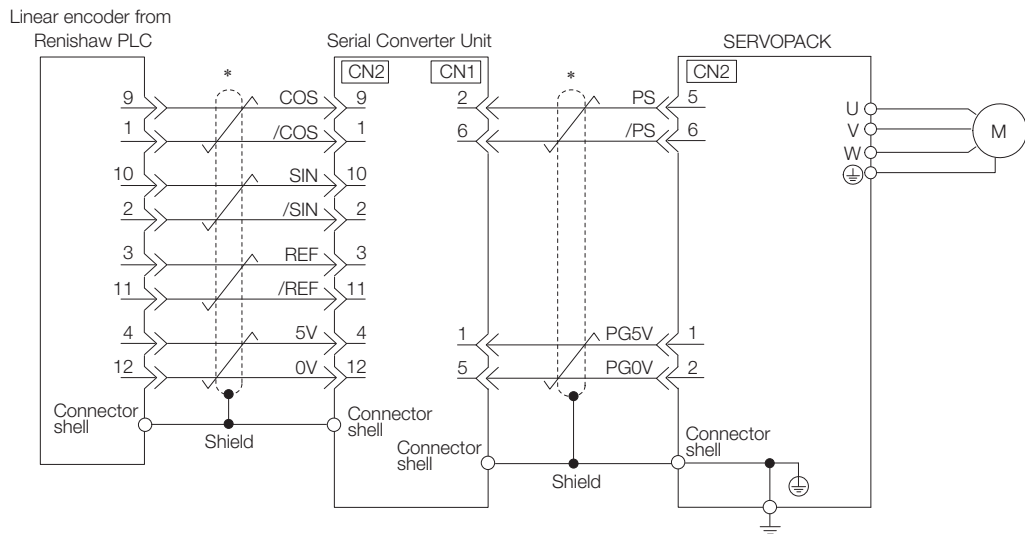

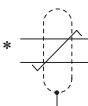

*  represents a shielded twisted-pair cable.

◆ Connections to Linear Encoder from Magnescale Co., Ltd.

If you use a linear encoder from Magnescale Co., Ltd., the wiring will depend on the model of the linear encoder.

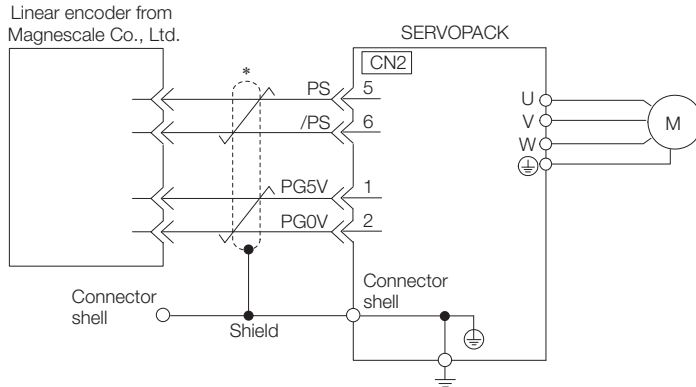
■ SR75 and SR85



*  represents a shielded twisted-pair cable.

■ SL700, SL710, SL720, SL730, and SQ10

- PL101-RY, MQ10-FLA, or MQ10-GLA Interpolator

The following table gives the Linear Encoder and Interpolator combinations.

Linear Encoder Model	Interpolator Model
SL700, SL710, SL720, and SL730	PL101-RY* ¹
SQ10	MQ10-FLA* ²
	MQ10-GLA* ²

*1. This is the model of the Head with Interpolator.

*2. This is the model of the Interpolator.

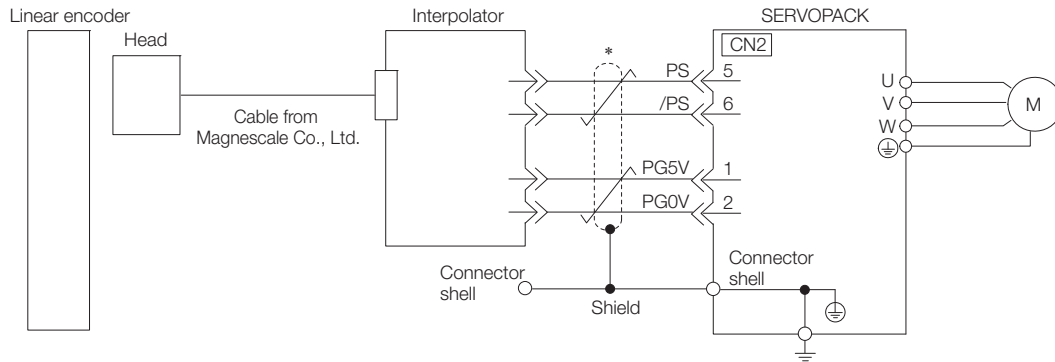

*  represents a shielded twisted-pair cable.

■ SL700, SL710, SL720, and SL730

- MJ620-T13 Interpolator

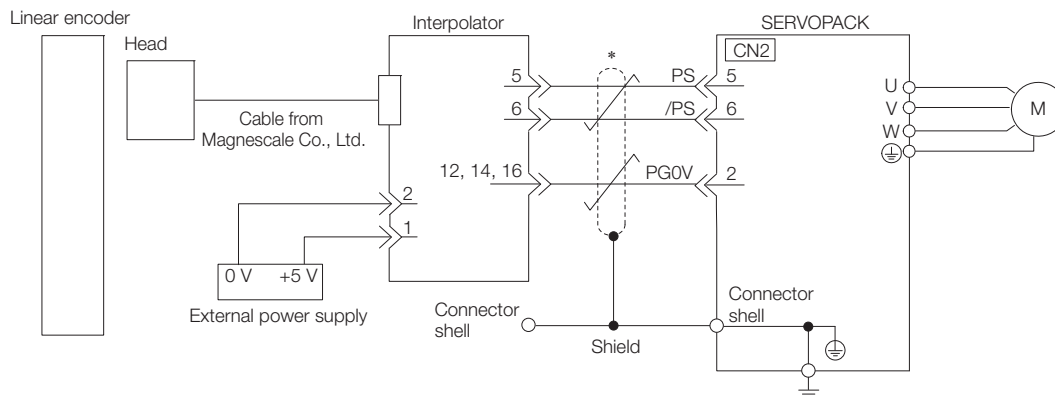

*  represents a shielded twisted-pair cable.

◆ Connections to Linear Encoder from Canon Precision Inc.

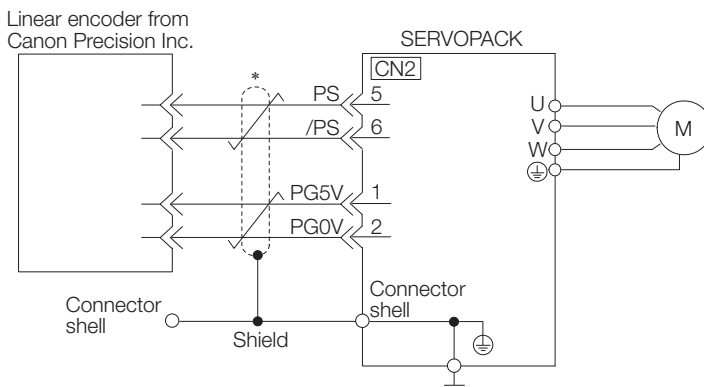

*  represents a shielded twisted-pair cable.

4.4.4 Wiring the SERVOPACK to the Holding Brake



Important

- If you use a Rotary Servomotor, select a Surge Absorber according to the brake current and brake power supply. Refer to the following manual for details.
 📖 Σ -7-Series Peripheral Device Selection Manual (Manual No.: SIEP S800001 32)
- After the Surge Absorber is connected, check the brake operation delay time in your application. The Surge Absorber may affect the brake operation delay time. Configure the relay circuit to activate the holding brake for an emergency stop.

Relay Circuit Example

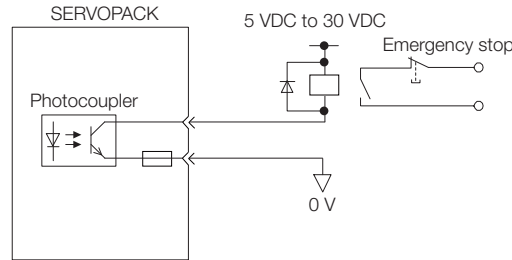

- If you use a 24-V brake, install a separate power supply for the 24-VDC power supply from other power supplies, such as the one for the I/O signals of the CN1 connector. If the power supply is shared, the I/O signals may malfunction.

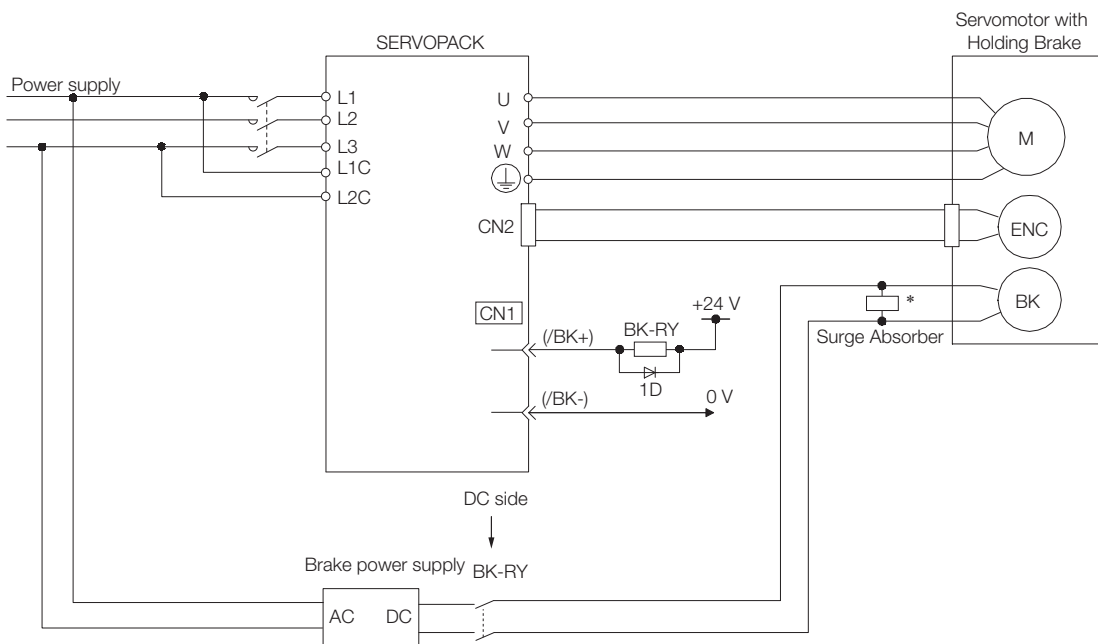

BK-RY: Brake control relay
 1D: Flywheel diode

* Install the surge absorber near the brake terminals on the Servomotor.

4.5 I/O Signal Connections

4.5.1 I/O Signal Connector (CN1)

This section describes the I/O signals of the SERVOPACK.

Names and Functions

The following table gives the pin numbers, names, and functions of the I/O signal pins.

◆ Input Signals



Note

You cannot change the pin allocations for the input signals on CN1.

Signal	Pin No.	Name	Function	Reference
/ALM-RST	7	Alarm Reset Input	–	page 15-49
P-OT	8	Forward Drive Prohibit Input	Stops Servomotor drive (to prevent over-travel) when the moving part of the machine exceeds the range of movement.	page 6-3
N-OT	9	Reverse Drive Prohibit Input		
/DEC	10	Homing Deceleration Switch Input	Connects the deceleration limit switch for homing.	page 6-3
Not used	11	–	–	–
/RGRT	12	Registration Input	Inputs the latch signal that is used for registration (external positioning).	page 6-4
/S-ON	13	Servo ON Input	Controls turning the Servomotor ON and OFF (supplying/not supplying power).	page 6-3
+24VIN	6	Sequence Input Signal Power Supply Input	Inputs the sequence input signal power supply. Allowable voltage range: 24 VDC \pm 20% The 24-VDC power supply is not provided by Yaskawa.	–
BAT+	14	Battery for Absolute Encoder (+)	These are the pins to connect the absolute encoder backup battery. Do not connect these pins if you use the Encoder Cable with a Battery Case.	–
BAT-	15	Battery for Absolute Encoder (-)		
TH	5	Overheat Protection Input	Inputs the overheat protection signal from a Linear Servomotor or from a sensor attached to the machine.	page 6-40

Note: If forward drive prohibition or reverse drive prohibition is used, the SERVOPACK is stopped by software controls. If the application does not satisfy the safety requirements, add external safety circuits as required.

◆ Output Signals

Default settings are given in parentheses.

Signal	Pin No.	Name	Function	Reference
ALM+	3	Servo Alarm Output	Turns OFF (opens) when an error is detected.	page 6-7
ALM-	4			
/SO1+ (/WARN+)	1	Warning Output	You can allocate the output signal to use with a parameter. (Error/Warning: ON for 2 seconds when an error has occurred. /WARN- ON continuously while a warning is being detected.)	page 6-8
/SO1- (/WARN-)	2			

Continued on next page.

Continued from previous page.

Signal	Pin No.	Name	Function	Reference
/SO2+ (/BK+)	23	Brake Output	You can allocate the output signal to use with a parameter. (Controls the brake. The brake is released when the signal turns ON (closes).)	page 6-8
/SO2- (/BK-)	24			
/SO3+ (/S-RDY+)	25	Servo Ready Output	You can allocate the output signal to use with a parameter. (Turns ON (closes) when the SERVOPACK is ready to acknowledge the /S-ON (Servo ON) signal.)	page 6-8
/SO3- (/S-RDY-)	26			
PAO	17	Encoder Divided Pulse Output, Phase A	Output the encoder divided pulse output signals with a 90° phase differential.	page 6-23 page 6-29
/PAO	18			
PBO	19	Encoder Divided Pulse Output, Phase B		
/PBO	20			
PCO	21	Encoder Divided Pulse Output, Phase C	Output the encoder origin signal.	
/PCO	22			
SG	16	Signal ground	This is the 0-V signal for the control circuits.	-
FG	Shell	Frame ground	Connected to the frame ground if the shield of the I/O Signal Cable is connected to the connector shell.	-

Pin Layout

The following figure gives the pin arrangement of the of the I/O signal connector (CN1) for the default settings.



The above view is from the direction of the following arrow without the connector shell attached.

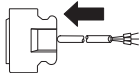

I/O Signal Wiring Examples

◆ Using a Rotary Servomotor

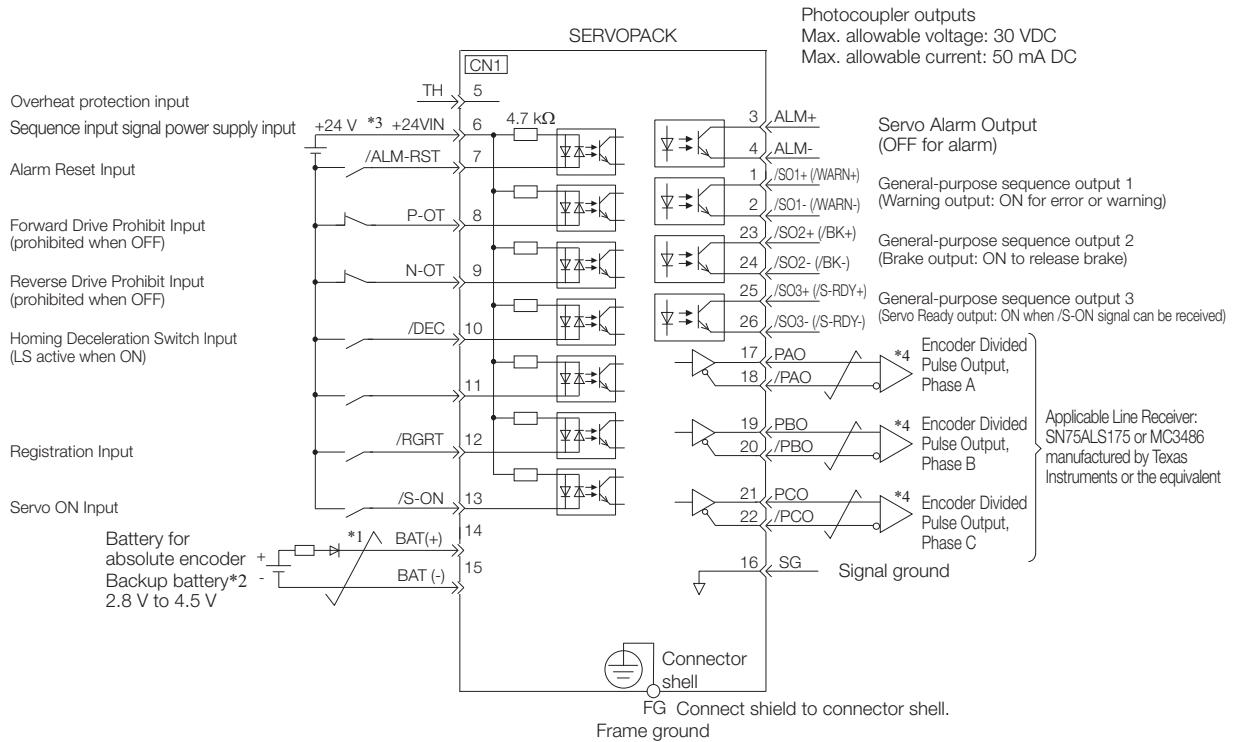

*1. represents twisted-pair wires.

*2. Connect these when using an absolute encoder. If the Encoder Cable with a Battery Case is connected, do not connect a backup battery.

*3. The 24-VDC power supply is not provided by Yaskawa. Use a 24-VDC power supply with double insulation or reinforced insulation.

*4. Always use line receivers to receive the output signals.

Note: If you use a 24-V brake, install a separate power supply for the 24-VDC power supply from other power supplies, such as the one for the I/O signals of the CN1 connector. If the power supply is shared, the I/O signals may malfunction.

◆ Using a Linear Servomotor

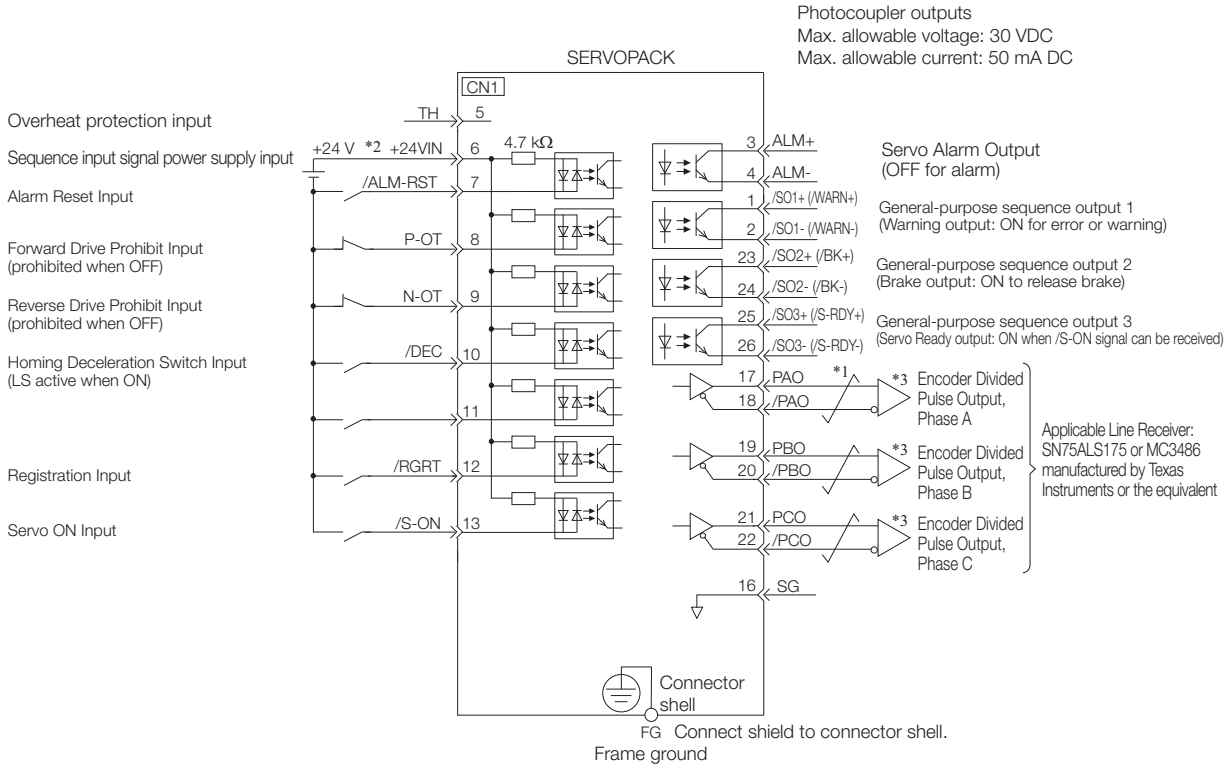

- *1. represents twisted-pair wires.
- *2. The 24-VDC power supply is not provided by Yaskawa. Use a 24-VDC power supply with double insulation or reinforced insulation.
- *3. Always use line receivers to receive the output signals.

Note: If you use a 24-V brake, install a separate power supply for the 24-VDC power supply from other power supplies, such as the one for the I/O signals of the CN1 connector. If the power supply is shared, the I/O signals may malfunction.

4.5.2 Input Signal Connector (CN11)

This section describes the I/O signals of the INDEXER Module.

Names and Functions

◆ Input Signals



Important

Ensure that the following condition does not last longer than 5 minutes. Otherwise the product life may be shortened.

- The ambient temperature is high, and,
- There is a high ratio of CN11 input signal contacts that are ON (closed)*1 (contact ON ratio*2).

The allowable ranges for ambient temperature and contact ON ratio are shown below.

Ambient temperature and input signal contact ON ratio

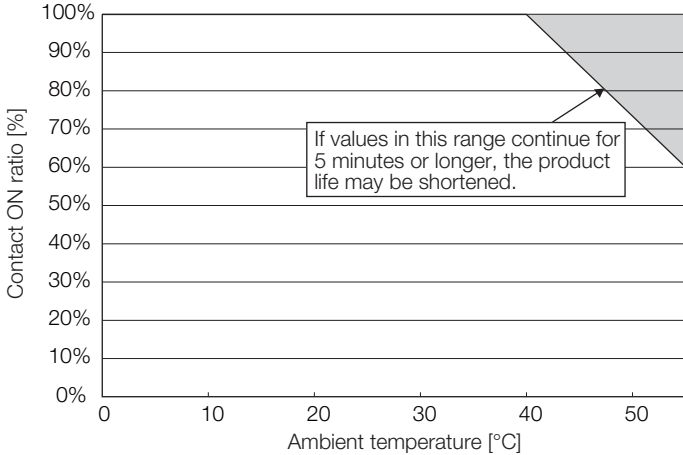

*1. The state that a contact is ON (closed) indicates, regardless of the logic of the input signal, that the contact is closed and that current is flowing in the input circuit.

*2. For example, a contact ON ratio of 100% indicates that 11 out of the 11 contacts are ON.

Signal Name	Pin No.	Function
+24V/COM	1	Power Supply for Sequence Signals. Voltage range: 24 VDC ±10%
/MODE 0/1	3	This pin switches between Mode 0 and Mode 1. ON: Mode 0 (program table operation) OFF: Mode 1 (JOG speed table operation or homing)
/START-STOP; /HOME	5	Mode 0: When ON, starts or restarts program table operation. Refers to signals /SEL0 through /SEL7 when starting operation. When OFF, interrupts program table operation. Mode 1: When ON, starts or restarts homing. When OFF, interrupts homing.
/PGMRES; /JOGP	7	Mode 0: When ON while program table operation is interrupted, resets program table operation. Mode 1: When ON, causes forward JOG operation. When OFF, stops forward JOG operation.
/SEL0; /JOGN	9	Mode 0: Program table 0 Mode 1: When ON, causes reverse JOG operation. When OFF, stops reverse JOG operation.
/SEL1; /JOG0	11	Mode 0: Program table selection 1 Mode 1: JOG speed table selection 0
/SEL2; /JOG1	13	Mode 0: Program table selection 2 Mode 1: JOG speed table selection 1
/SEL3; /JOG2	15	Mode 0: Program table selection 3 Mode 1: JOG speed table selection 2

Continued on next page.

Continued from previous page.

Signal Name	Pin No.	Function
/SEL4; /JOG3	17	Mode 0: Program table selection 4 Mode 1: JOG speed table selection 3
/SEL5	14	Mode 0: Program table selection 5 Mode 1: –
/SEL6	16	Mode 0: Program table selection 6 Mode 1: –
/SEL7	18	Mode 0: Program table selection 7 Mode 1: –

◆ Output Signals

Signal Name	Pin No.	Function
/INPOSITION+	19	Positioning complete
/INPOSITION -	20	
/POUT0+	21	Programmable outputs
/POUT0-	22	
/POUT1+	23	
/POUT1-	24	
/POUT2+	25	
/POUT2-	26	
/POUT3+	27	
/POUT3-	28	
/POUT4+	29	
/POUT4-	30	
/POUT5+	31	
/POUT5-	32	
/POUT6+	33	
/POUT6-	34	
/POUT7+	35	
/POUT7-	36	

Connection Example

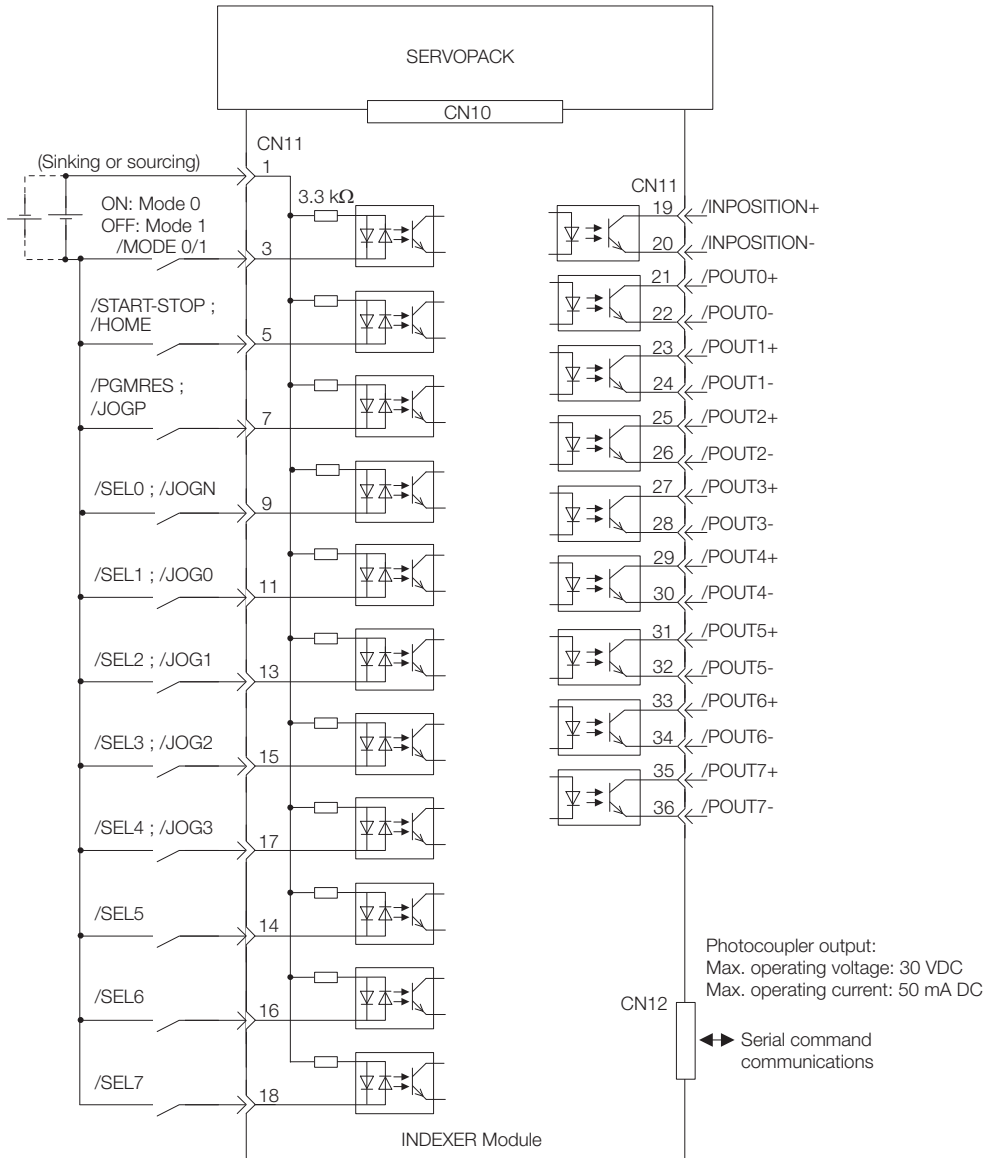

Note: /START-STOP, /PGMRES, /SEL0, /SEL1, /SEL2, /SEL3, /SEL4, /SEL5, /SEL6, and /SEL7 signals are valid when Mode 0 is set. /HOME, /JOGP, /JOGN, /JOG0, /JOG1, /JOG2, and /JOG3 signals are valid when Mode 1 is set.

4.5.3 I/O Circuits

Sequence Input Circuits

◆ Photocoupler Input Circuits

This section describes CN1 connector terminals 6 to 13.

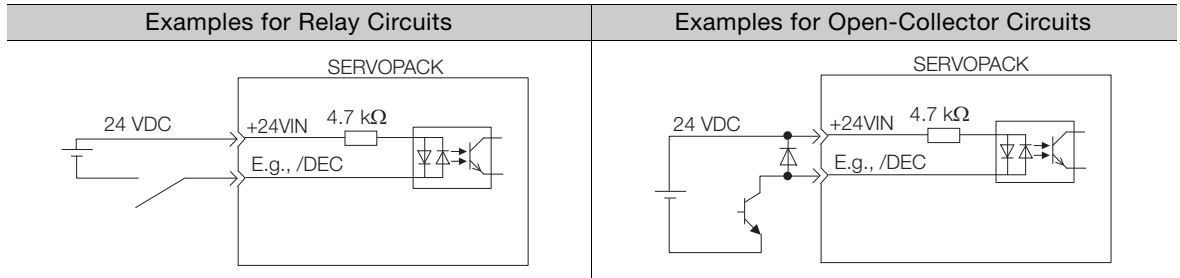

Note: The 24-VDC external power supply capacity must be 50 mA minimum.

The SERVOPACK input circuits use bidirectional photocouplers. Select either a sink circuit or source circuit according to the specifications required by the machine.

Note: The connection examples in *I/O Signal Wiring Examples* on page 4-38 are for sink circuit connections.

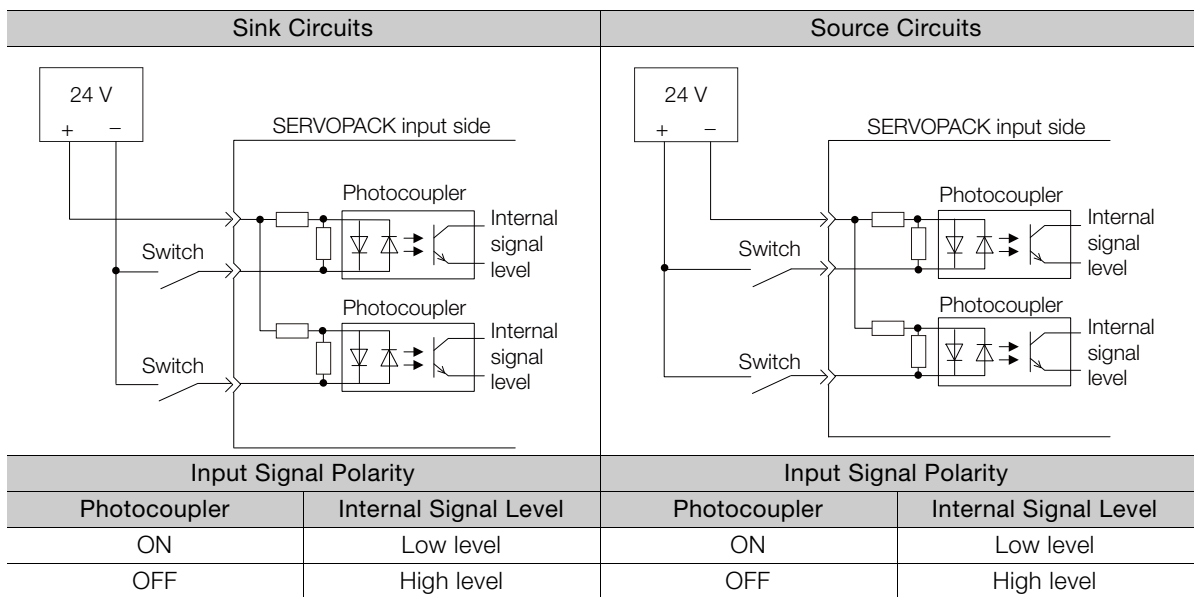

Sequence Output Circuits



Important

Incorrect wiring or incorrect voltage application to the output circuits may cause short-circuit failures.

If a short-circuit failure occurs as a result of any of these causes, the holding brake will not work. This could damage the machine or cause an accident that may result in death or injury.

◆ Photocoupler Output Circuits

Photocoupler output circuits are used for the ALM (Servo Alarm), /S-RDY (Servo Ready), and other sequence output signals. Connect an open-collector output circuit to a photocoupler, relay, or line-receiver circuit.

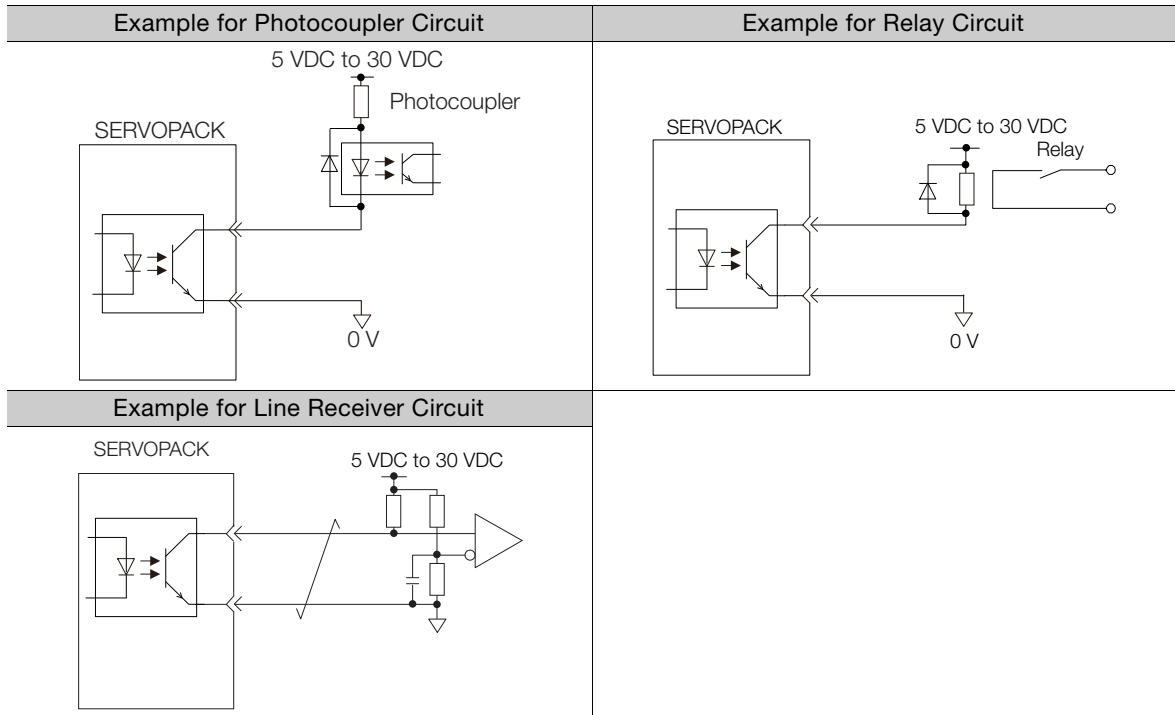

Note: The maximum allowable voltage and current range for photocoupler output circuits are as follows:

- Maximum allowable voltage: 30 VDC
- Current range: 5 mA to 50 mA DC

◆ Line-Driver Output Circuits

This section describes CN1 connector terminals 17-18 (Phase-A Signal), 19-20 (Phase-B Signal), and 21-22 (Phase-C Signal).

The serial data from the encoder is converted to two-phase (phases A and B) pulses. The resulting output signals (PAO, /PAO and PBO, /PBO), encoder phase C output signals (PCO and /PCO), and the absolute encoder position output signals (PSO and /PSO) are output with line-driver output circuits. Connect the line-driver output circuits to line-receiver circuits at the host controller.

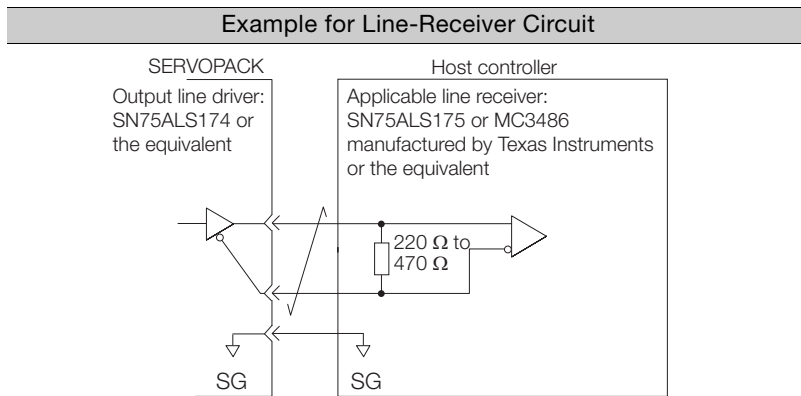

4.6

Serial Command Communications Connector (CN12)

The CN12 connector on the INDEXER Module is used for serial command communications.

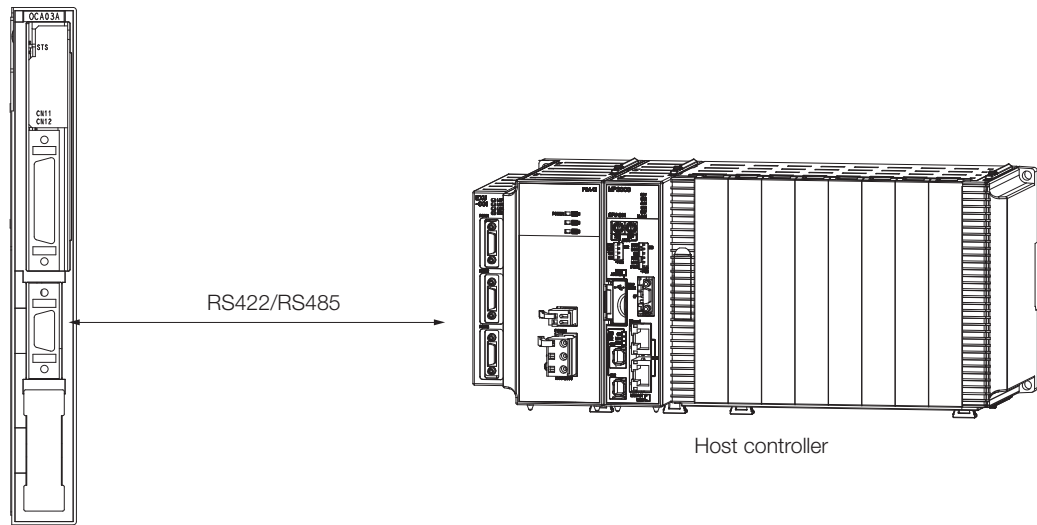

4.6.1 Connector Mode

INDEXER Module-end Connector	Applicable Receptacles		
	Solder Type	Case	Manufacturer
10214-52A2PL 14 P	10114-3000PE	10314-52A0-008	3M Japan Ltd.

4.6.2 Connector Signal Names

Pin No.	Signal Name	Signal Circuit Name	Signal Direction
1	TXD	Transmit data (not inverted)	Host controller ← INDEXER Module
2	/TXD	Transmit data (inverted)	Host controller ← INDEXER Module
3	RXD	Receive data (not inverted)	Host controller → INDEXER Module
4	/RXD	Receive data (inverted)	Host controller → INDEXER Module
5	GND	Signal ground (0 V)	—
6	/RXD	Receive data (inverted)	—
7	RT	If RT and /RXD are connected (shorted), the built-in terminator (120 Ω) will be connected between RXD and /RXD.	
8	TXD	Transmit data (not inverted)	Next axis ← INDEXER Module
9	/TXD	Transmit data (inverted)	Next axis ← INDEXER Module
10	RXD	Receive data (not inverted)	Next axis → INDEXER Module
11	Reserved	Reserved pin	—
12	Reserved	Reserved pin	—
13	Reserved	Reserved pin	—
14	GND	Signal ground (0 V)	—

4.6.3 Connection Examples

Full-duplex Wiring

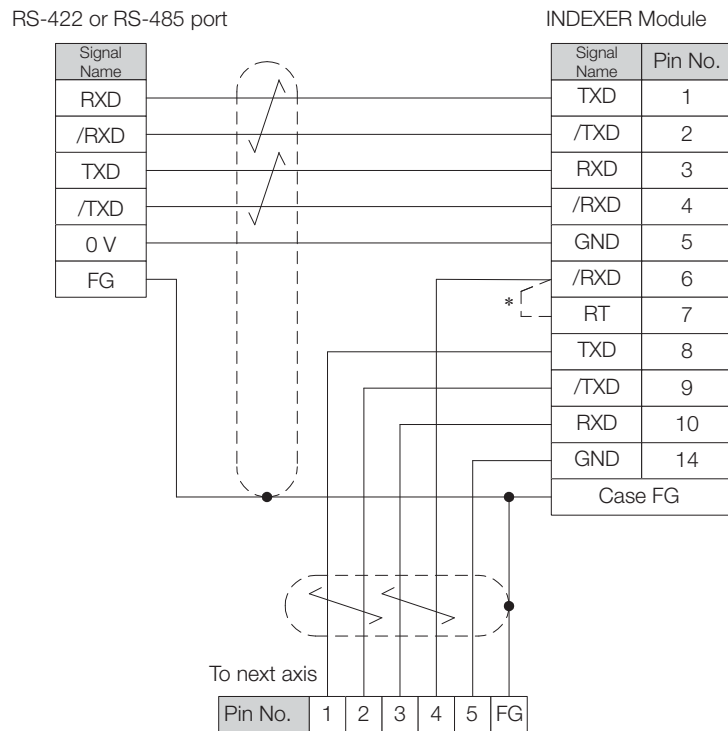

* Connect (short) the RT and /RXD pins in the last axis.

Note: Cable length: 50 m max.

Half-duplex Wiring

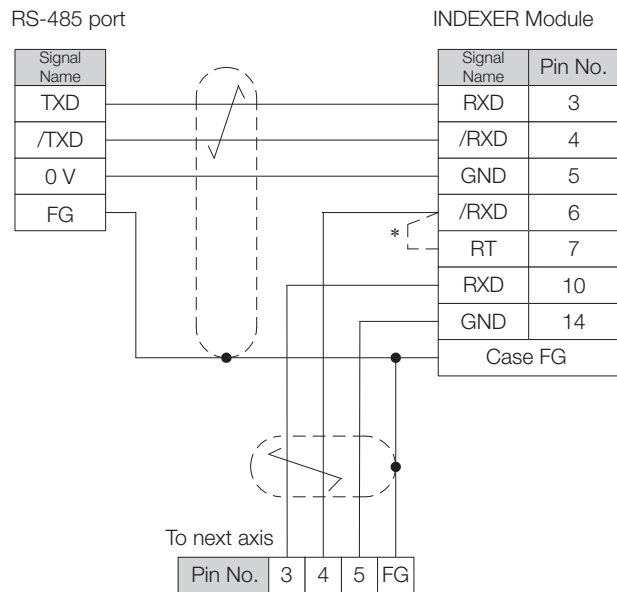

* Connect (short) the RT and /RXD pins in the last axis.

4.6.4 Wiring Precautions

- The maximum total length for RS-422 or RS-485 cable is 50 m. Use the minimum length of cable that is needed.
- The INDEXER Module's communications circuits are not insulated. If communications errors occur because of noise, use noise suppression methods such as shielded cable or ferrite cores.
- When using full-duplex wiring, connect a terminator in the host controller's reception circuit and the reception circuit of the last INDEXER Module in the line. The INDEXER Module has a built-in terminator (120 Ω) that is connected between the RXD and /RXD pins when the RT and /RXD pins are shorted.
- When using half-duplex wiring, connect a terminator at both ends of the communications cable. The INDEXER Module has a built-in terminator (120 Ω) that is connected between the RXD and /RXD pins when the RT and /RXD pins are shorted.
- The INDEXER Module's transmission circuit is high-impedance when it is not transmitting. Pull up or pull down the host controller's reception circuit.

4.7 Connecting Safety Function Signals

This section describes the wiring required to use a safety function.

Refer to the following chapter for details on the safety function.

 Chapter 11 Safety Functions

4.7.1 Pin Arrangement of Safety Function Signals (CN8)

Pin No.	Signal	Name	Function
1	-	-	(Do not use these pins because they are connected to internal circuits.)
2	-		
3	/HWBB1-	Hard Wire Base Block Input 1	For a hard wire base block input. The base block (motor power turned OFF) is in effect when the signal is OFF.
4	/HWBB1+		
5	/HWBB2-	Hard Wire Base Block Input 2	
6	/HWBB2+		
7	EDM1-	External Device Monitor Output	Turns ON when the /HWBB1 and the /HWBB2 signals are input and the SERVOPACK enters a base block state.
8	EDM1+		

4.7.2 I/O Circuits



Important

For safety function signal connections, the input signal is the 0-V common and the output signal is a source output. This is opposite to other signals described in this manual. To avoid confusion, the ON and OFF status of signals for the safety function are defined as follows:

- ON: The state in which the relay contacts are closed or the transistor is ON and current flows into the signal line.
- OFF: The state in which the relay contacts are open or the transistor is OFF and no current flows into the signal line.

Safety Input Circuits

Use a 0-V common to connect the safety function signals. You must connect redundant input signals.

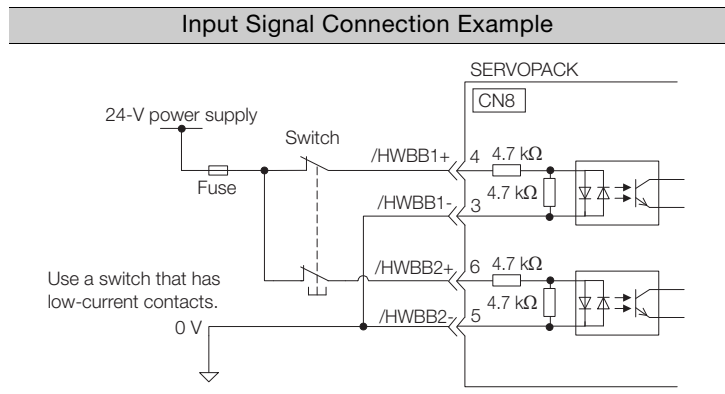

◆ Input (HWBB) Signal Specifications

Type	Signal	Connector Pin No.	Status	Meaning
Inputs	/HWBB1	CN8-4 CN8-3	ON (closed)	Does not activate the HWBB (normal operation).
			OFF (open)	Activates the HWBB (motor current shut-OFF request).
	/HWBB2	CN8-6 CN8-5	ON (closed)	Does not activate the HWBB (normal operation).
			OFF (open)	Activates the HWBB (motor current shut-OFF request).

The input (HWBB) signals have the following electrical characteristics.

Item	Characteristics	Remarks
Internal Impedance	4.7 k Ω	–
Operating Voltage Range	+24 V \pm 20%	–
Maximum Delay Time	8 ms	Time from /HWBB1 and /HWBB2 signals turning OFF until HWBB is activated

Diagnostic Output Circuits

The EDM1 output signal uses a source circuit. The following figure shows a connection example.

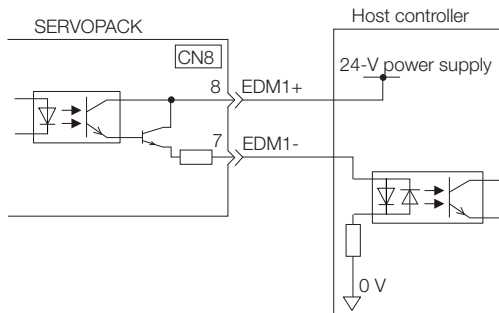

◆ EDM1 Output Signal Specifications

Type	Signal	Pin No.	Output Status	Meaning
Output	EDM1	CN8-8 CN8-7	ON	Both the /HWBB1 and /HWBB2 signals are operating normally.
			OFF	The /HWBB1 signal, the /HWBB2 signal, or both are not operating.

The electrical characteristics of the EDM1 signal are as follows:

Item	Characteristics	Remarks
Maximum Allowable Voltage	30 VDC	–
Maximum Allowable Current	50 mA DC	–
Maximum ON Voltage Drop	1.0 V	Voltage between EDM1+ and EDM1- when current is 50 mA
Maximum Delay Time	8 ms	Time from a change in /HWBB1 or /HWBB2 until a change in EDM1

4.8 Connecting the Other Connectors

4.8.1 Serial Communications Connector (CN3)

To use a Digital Operator, connect it to CN3 on the SERVOPACK.

Refer to the following manual for the operating procedures for the Digital Operator.

📖 Σ -7-Series Digital Operator Operating Manual (Manual No.: SIEP S800001 33)

4.8.2 Computer Connector (CN7)

To use the SigmaWin+ Engineering Tool, connect the computer on which the SigmaWin+ is installed to CN7 on the SERVOPACK.

Refer to the following manual for the operating procedures for the SigmaWin+.

📖 Engineering Tool SigmaWin+ Online Manual (Manual No.: SIEP S800001 48)



Use the Yaskawa-specified cables. Operation will not be dependable due to low noise resistance with any other cable.

4.8.3 Analog Monitor Connector (CN5)

To use an analog monitor, connect CN5 on the SERVOPACK.

- Wiring Example

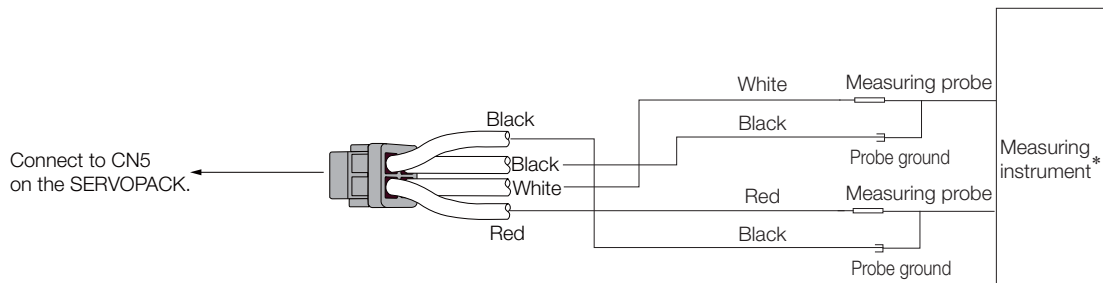

* The measuring instrument is not provided by Yaskawa.

Refer to the following section for information on the monitoring methods for an analog monitor.

📖 9.3 Monitoring Machine Operation Status and Signal Waveforms on page 9-7

Basic Functions That Require Setting before Operation

5

This chapter describes the basic functions that must be set before you start servo system operation. It also describes the setting methods.

5.1	Manipulating Parameters (Pn□□□)	5-3
5.1.1	Parameter Classification	5-3
5.1.2	Notation for Parameters	5-4
5.1.3	Parameter Setting Methods	5-5
5.1.4	Write Prohibition Setting for Parameters	5-6
5.1.5	Initializing Parameter Settings	5-10
5.2	Power Supply Type Settings for the Main Circuit and Control Circuit . .	5-12
5.2.1	AC Power Supply Input/DC Power Supply Input Setting	5-12
5.2.2	Single-phase AC Power Supply Input/ Three-phase AC Power Supply Input Setting . .	5-13
5.3	Automatic Detection of Connected Motor . .	5-14
5.4	Motor Direction Setting	5-15
5.5	Setting the Linear Encoder Pitch	5-16
5.6	Writing Linear Servomotor Parameters . . .	5-17
5.7	Selecting the Phase Sequence for a Linear Servomotor . .	5-21
5.8	Polarity Sensor Setting	5-23

5.9	Polarity Detection	5-24
5.9.1	Restrictions	5-24
5.9.2	Using the /S-ON (Servo ON) Signal to Perform Polarity Detection	5-25
5.9.3	Using a Tool Function to Perform Polarity Detection	5-26
5.10	Overtravel and Related Settings	5-27
5.10.1	Overtravel Signals	5-27
5.10.2	Overtravel Settings	5-28
5.10.3	Motor Stopping Method When Overtravel is Used	5-28
5.10.4	Overtravel Warnings	5-29
5.11	Holding Brake	5-31
5.11.1	Brake Operating Sequence	5-31
5.11.2	Allocating the /BK (Brake) Signal	5-32
5.11.3	Output Timing of /BK (Brake) Signal When the Servomotor Is Stopped	5-33
5.11.4	Output Timing of /BK (Brake) Signal When the Servomotor Is Operating	5-33
5.12	Motor Stopping Methods for Servo OFF and Alarms	5-35
5.12.1	Stopping Method for Servo OFF	5-36
5.12.2	Servomotor Stopping Method for Alarms	5-36
5.13	Motor Overload Detection Level	5-39
5.13.1	Detection Timing for Overload Warnings (A.910)	5-39
5.13.2	Detection Timing for Overload Alarms (A.720)	5-40
5.14	Electronic Gear Settings	5-41
5.14.1	Electronic Gear Ratio Settings	5-42
5.14.2	Electronic Gear Ratio Setting Examples	5-47
5.15	Resetting the Absolute Encoder	5-48
5.15.1	Precautions on Resetting	5-48
5.15.2	Preparations	5-48
5.15.3	Applicable Tools	5-49
5.15.4	Operating Procedure	5-49
5.16	Setting the Origin of the Absolute Linear Encoder	5-51
5.16.1	Preparations	5-51
5.16.2	Applicable Tools	5-51
5.16.3	Operating Procedure	5-52
5.17	Setting the Regenerative Resistor Capacity	5-54

5.1 Manipulating Parameters (Pn□□□)

This section describes the classifications, notation, and setting methods for the parameters given in this manual.

5.1.1 Parameter Classification

There are the following two types of SERVOPACK parameters.

Classification	Meaning
Setup Parameters	Parameters for the basic settings that are required for operation.
Tuning Parameters	Parameters that are used to adjust servo performance.



Important

When you edit parameters with the SigmaWin+, setup parameters and tuning parameters are displayed.

When you edit parameters with a Digital Operator, only setup parameters are displayed by default. To edit tuning parameters, set Pn00B to n.□□□1 (Display all parameters).

Parameter	Meaning	When Enabled	Classification
Pn00B	n.□□□0 (default setting)	After restart	Setup
	n.□□□1		

The setting method for each type of parameter is described below.

Setup Parameters

You can use the Digital Operator, or SigmaWin+ to set the setup parameters individually.

Information

We recommend that you use the Setup Wizard of the SigmaWin+ to easily set the required setup parameters by setting the operating methods, machine specifications, and I/O signals according to on-screen Wizard instructions.

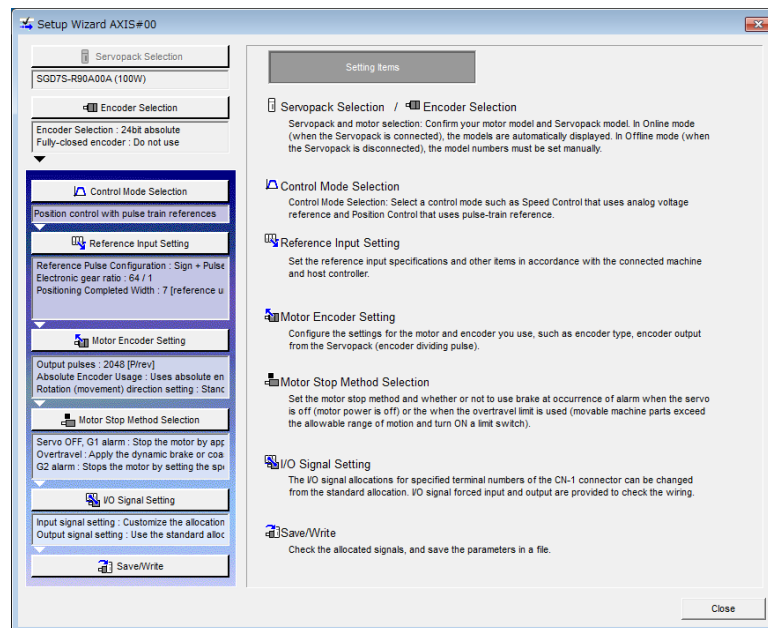

Tuning Parameters

Normally the user does not need to set the tuning parameters individually.

Use the various SigmaWin+ tuning functions to set the related tuning parameters to increase the response even further for the conditions of your machine. Refer to the following sections for details.

- 📖 8.6 Autotuning without Host Reference on page 8-23
- 📖 8.7 Autotuning with a Host Reference on page 8-34
- 📖 8.8 Custom Tuning on page 8-41

You can also set the tuning parameters individually to make adjustments. Refer to the following section for details.

- 📖 8.13 Manual Tuning on page 8-73

5.1.2 Notation for Parameters

There are two types of notation used for parameters that depend on whether the parameter requires a numeric setting (parameter for numeric setting) or requires the selection of a function (parameter for selecting a function).

Parameters for Numeric Settings

Pn100	Speed Loop Gain				
	Setting Range	Setting Unit	Default Setting	When Enabled	Classification
	10 to 20,000	0.1 Hz	400	Immediately	Tuning



Parameters for Selecting Functions

Parameter	Meaning	When Enabled	Classification
Pn002	n.□0□□ (default setting)	After restart	Setup
	n.□1□□		
	n.□2□□		

5.1.3 Parameter Setting Methods

You can use the SigmaWin+ or a Digital Operator to set parameters.
Use the following procedure to set the parameters.

Setting Parameters with the SigmaWin+

1. Click the  Servo Drive Button in the workspace of the Main Window of the SigmaWin+.
2. Select **Edit Parameters** in the Menu Dialog Box.
The Parameter Editing Dialog Box will be displayed.
3. Click the cell of the parameter to edit.
If the parameter to edit is not displayed in the Parameter Editing Dialog Box, click the  or  Button to display the parameter to edit.

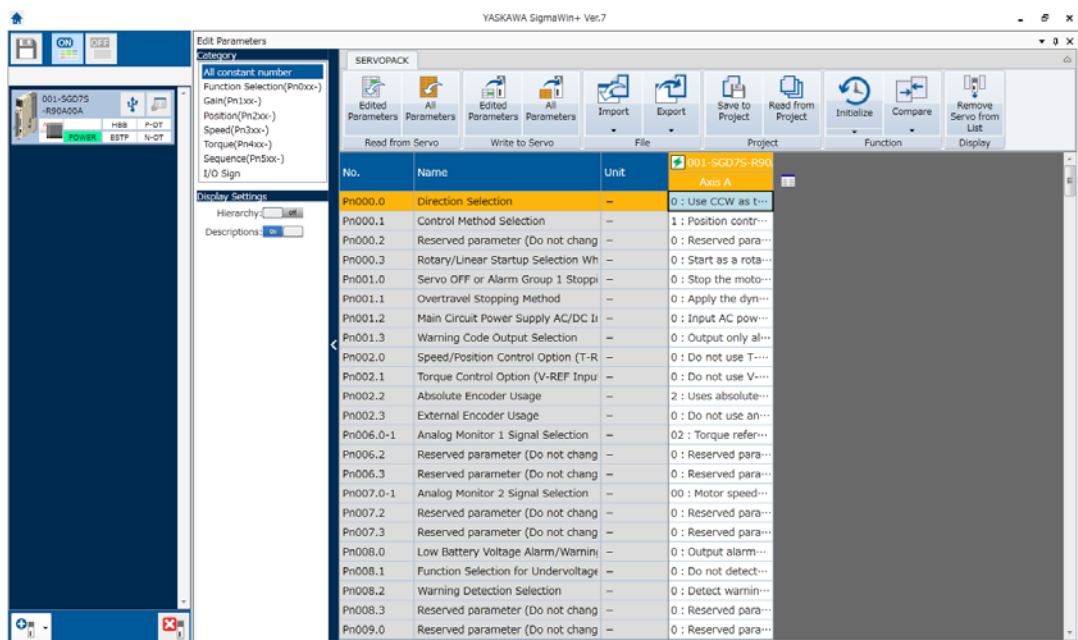

4. Change the setting of the parameter.
 - Information** 1. For a parameter for a numeric setting, input the numeric setting.
 - 2. If the parameter requires selection of a function, select the function from the list of selections.
5. Press the **Enter Key**.
The background of the edited parameter cell will change to green.

5.1 Manipulating Parameters (Pn□□□)

5.1.4 Write Prohibition Setting for Parameters

6. Select Edited Parameters in the Write to Servo Group.

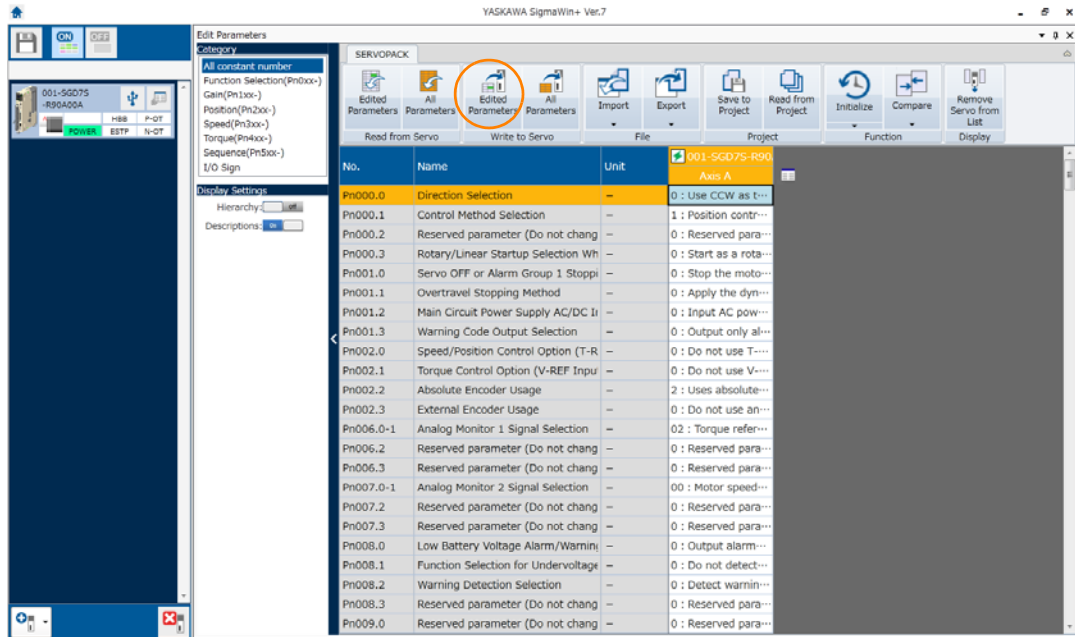

The edited parameters are written to the SERVOPACK and the backgrounds of the cells change to white.

7. Click the OK Button.

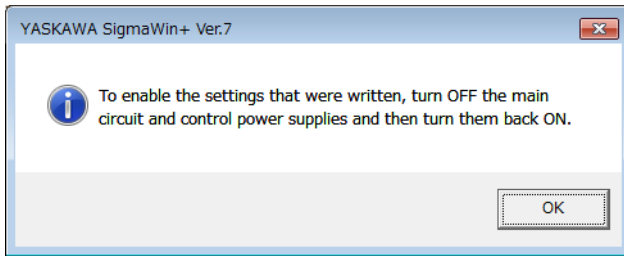

8. To enable changes to the settings, turn the power supply to the SERVOPACK OFF and ON again.

This concludes the procedure to set the parameters.

Setting Parameters with a Digital Operator

Refer to the following manual for information on setting the parameters with a Digital Operator.
 Σ-7-Series Digital Operator Operating Manual (Manual No.: SIEP S800001 33)

5.1.4 Write Prohibition Setting for Parameters



You can prohibit writing parameters from the Digital Operator. Even if you do, you will still be able to change parameter settings from the SigmaWin+.

Preparations

No preparations are required.



Applicable Tools

The following table lists the tools that you can use to change the Write Prohibition Setting.

Tool	Fn No./Function Name	Reference
Digital Operator	Fn010	 Σ -7-Series Digital Operator Operating Manual (Manual No.: SIEP S80001 33)
SigmaWin+	Others - Write Prohibited Setting	 Operating Procedure on page 5-7

Operating Procedure

Use the following procedure to prohibit or permit writing parameter settings.

1. Click the  Servo Drive Button in the workspace of the Main Window of the SigmaWin+.
2. Select **Write Prohibition Setting** in the Menu Dialog Box.
The Write Prohibition Setting Dialog Box will be displayed.
3. Press the  or  for the rightmost digit and set one of the following.
0000: Writing is permitted (default setting).
0001: Writing is prohibited.

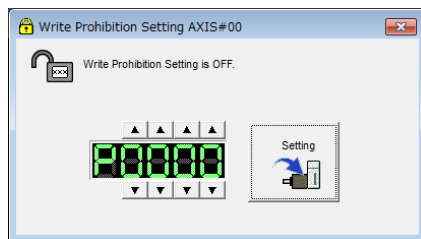

4. Click the **Setting** Button.

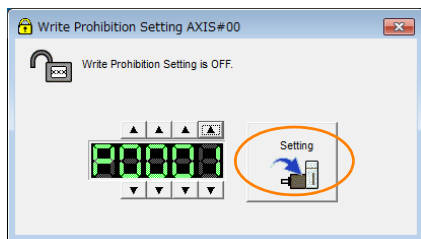

5. Click the **OK** Button.
The setting will be written to the SERVOPACK.

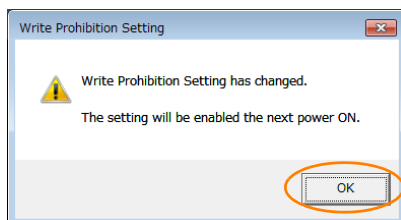

6. To enable the new setting, turn the power supply to the SERVOPACK OFF and ON again.

This concludes the procedure to prohibit or permit writing parameter settings.

Restrictions

If you prohibit writing parameter settings, you will no longer be able to execute some functions. Refer to the following table.

SigmaWin+		Digital Operator		When Writing Is Prohibited	Reference
Button in Menu Dialog Box	SigmaWin+ Function Name	Fn No.	Utility Function Name		
Basic Functions	Initialize* ¹	FnB0B	Initialize INDEXER Parameter Settings	Cannot be executed.	page 5-10
	Software Reset	Fn030	Software Reset	Can be executed.	page 6-30
	Product Information	Fn011	Display Servomotor Model	Can be executed.	page 9-2
		Fn012	Display Software Version	Can be executed.	
		Fn01E	Display SERVOPACK and Servomotor IDs	Can be executed.	
Fn01F		Display Servomotor ID from Feedback Option Module	Can be executed.		
Encoder Setting	Absolute Encoder Reset	Fn008	Reset Absolute Encoder	Cannot be executed.	page 5-48
	Multi-turn Limit Setup	Fn013	Multiturn Limit Setting after Multiturn Limit Disagreement Alarm	Cannot be executed.	page 6-26
	Search Origin* ²	Fn003	Origin Search	Cannot be executed.	page 7-19
	Zero Point Position Setting	Fn020	Set Absolute Linear Encoder Origin	Cannot be executed.	page 5-51
	Polarity Detection	Fn080	Polarity Detection	Cannot be executed.	page 5-26
	–	FnB09	Set Absolute Encoder Origin	Cannot be executed.	page 12-6
Table Editing	Edit Program Table	FnB03	Edit/Save Program Table	Cannot be executed.	page 13-14
		FnB06	Initialize Program Table	Cannot be executed.	
	Edit ZONE Table	FnB04	Edit/Save ZONE Table	Cannot be executed.	page 13-55
		FnB07	Initialize ZONE Table	Cannot be executed.	
	Edit Jog Speed Table	FnB05	Edit/Save Jog Speed Table	Cannot be executed.	page 13-46
		FnB08	Initialize Jog Speed Table	Cannot be executed.	
Trouble-shooting	Display Alarm	FnB0D	Display INDEXER Alarm History	Can be executed.	page 15-51
		FnB0C	Reset INDEXER Alarm History	Cannot be executed.	page 15-52
			Reset INDEXER Alarm	Cannot be executed.	page 15-49
	Fn014	Reset Option Module Configuration Error	Cannot be executed.	page 15-53	
	Reset Motor Type Alarm	Fn021	Reset Motor Type Alarm	Cannot be executed.	page 15-55
Operation	Jog	Fn002	Jog	Cannot be executed.	page 7-6
	Program JOG Operation	Fn004	Jog Program	Cannot be executed.	page 7-13

Continued on next page.

Continued from previous page.

SigmaWin+		Digital Operator		When Writing Is Prohibited	Reference
Button in Menu Dialog Box	SigmaWin+ Function Name	Fn No.	Utility Function Name		
Monitor	Monitor	FnB0A	INDEXER Status Monitor	Can be executed.	page 9-3
Tuning	Tuning - Autotuning without Host Reference	Fn201	Advanced Autotuning without Reference	Cannot be executed.	page 8-23
	Tuning - Autotuning with Host Reference	Fn202	Advanced Autotuning with Reference	Cannot be executed.	page 8-34
	Tuning - Custom Tuning	Fn203	One-Parameter Tuning	Cannot be executed.	page 8-41
	Tuning - Custom Tuning - Adjust Anti-resonance Control	Fn204	Adjust Anti-resonance Control	Cannot be executed.	page 8-49
	Tuning - Custom Tuning - Vibration Suppression	Fn205	Vibration Suppression	Cannot be executed.	page 8-54
	Response Level Setting	Fn200	Tuning-less Level Setting	Cannot be executed.	page 8-11
Diagnostic	Easy FFT	Fn206	Easy FFT	Cannot be executed.	page 8-89
Others	Adjust the Analog Monitor Output	Fn00C	Adjust Analog Monitor Output Offset	Cannot be executed.	page 9-10
		Fn00D	Adjust Analog Monitor Output Gain	Cannot be executed.	
	Adjust the Motor Current Detection Offsets	Fn00E	Autotune Motor Current Detection Signal Offset	Cannot be executed.	page 6-36
		Fn00F	Manually Adjust Motor Current Detection Signal Offset	Cannot be executed.	
	Initialize Vibration Detection Level	Fn01B	Initialize Vibration Detection Level	Cannot be executed.	page 6-32
	Write Prohibited Setting	Fn010	Write Prohibition Setting	Can be executed.	page 5-6

*1. An **Initialize** Button will be displayed in the Parameter Editing Dialog Box.

*2. Cannot be used when connecting a Linear Servomotor.

5.1.5 Initializing Parameter Settings

You can return the parameters to their default settings. This function restores the factory settings and initializes the parameters of both the SERVOPACK and the INDEXER Module.

This function will not initialize the settings of the parameters that are adjusted for the Fn00C, Fn00D, Fn00E, and Fn00F utility functions.



- To bring the settings into effect, always turn the SERVOPACK power supply off and back on after this operation.
- The parameters of the INDEXER Module are not initialized with Fn005. To initialize these parameters, execute FnB0B.

Preparations

Always check the following before you initialize the parameter settings.

- The parameters must not be write prohibited.
- The servo must be OFF.
- Initializing the parameter settings must not be in progress for any other tool.
- Execution of the RES command must not be in progress.

Applicable Tools

The following table lists the tools that you can use to initialize the parameter settings.

Tool	Fn No./Function Name	Reference
Digital Operator	FnB0B	Σ-7-Series Digital Operator Operating Manual (Manual No.: SIEP S80001 33)
SigmaWin+	Basic Functions - Edit Parameters	Operating Procedure on page 5-10
Serial command communications	PRMINIT (Parameter Initialization) command	Parameter Editing Commands on page 14-30

Operating Procedure

Use the following procedure to initialize the parameter settings.

1. Click the Servo Drive Button in the workspace of the Main Window of the SigmaWin+.
2. Select **Edit Parameters** in the Menu Dialog Box.
The Parameter Editing Dialog Box will be displayed.
3. Select any parameter of the axis to initialize.

4. Click the Initialize Button in the Function Group.

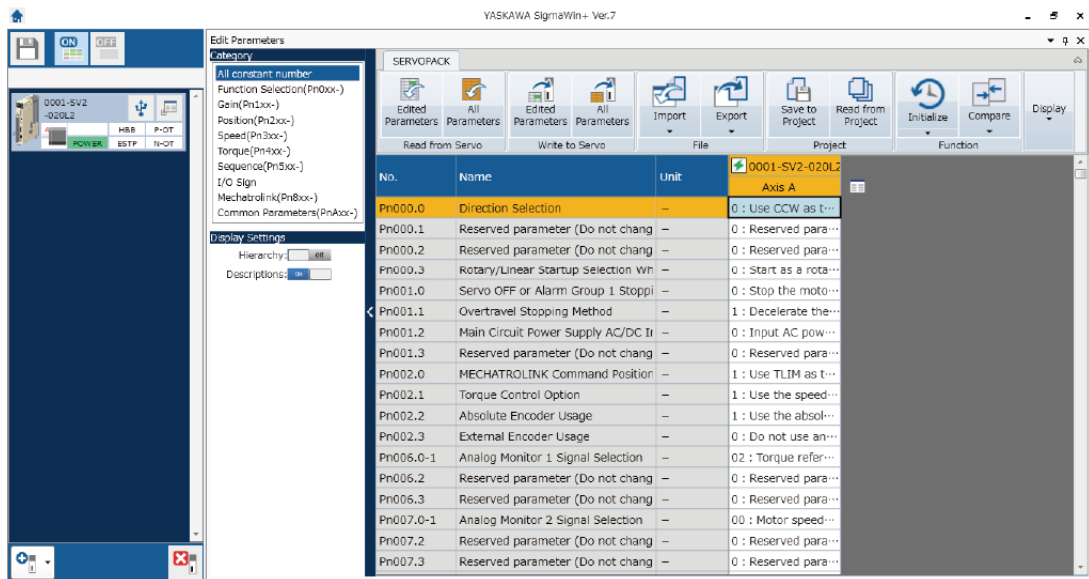

5. Click the OK Button.

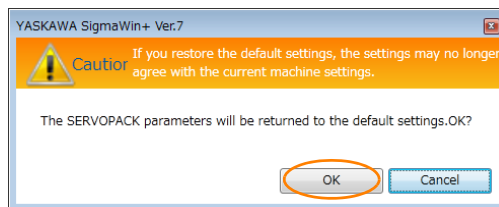

Click the **Cancel** Button to cancel initialization. The Parameter Editing Dialog Box will return.

6. Click the OK Button.

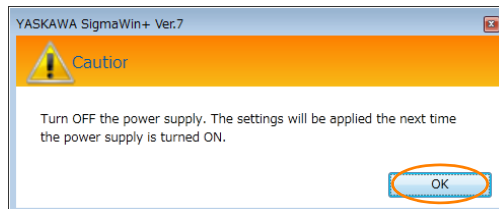

7. Turn the power supply to the SERVOPACK OFF and ON again after the parameter settings have been initialized.

This concludes the procedure to initialize the parameter settings.

5.2 Power Supply Type Settings for the Main Circuit and Control Circuit

A SERVOPACK with a 200-VAC power supply input can be operated on either an AC power supply input or DC power supply input to the main and control circuits. If you select an AC power supply input, you can operate the SERVOPACK on either a single-phase power supply input or a three-phase power supply input. This section describes the settings related to the power supplies.

You cannot input DC power to a SERVOPACK with a single-phase, 100-VAC power supply input.

5.2.1 AC Power Supply Input/DC Power Supply Input Setting

Set Pn001 = n.□X□□ (Main Circuit Power Supply AC/DC Input Selection) to specify whether to use an AC or DC power supply input for the main circuit power supply to the SERVOPACK. If the setting of Pn001 = n.□X□□ does not agree with the actual power supply input, an A.330 alarm (Main Circuit Power Supply Wiring Error) will occur.

Example

Examples of When an A.330 Alarm (Main Circuit Power Supply Wiring Error) Occurs

- A DC power supply is connected between the B1/⊕ and ⊖2 terminals, but an AC power supply input is specified (Pn001 = n.□0□□).
- An AC power supply is input to the L1, L2, and L3 terminals, but a DC power supply is specified (Pn001 = n.□1□□).

Parameter		Meaning	When Enabled	Classification
Pn001	n.□0□□ (default setting)	Use an AC power supply input.	After restart	Setup
	n.□1□□	Use a DC power supply input.		

WARNING

- Connect the AC or DC power supplies to the specified SERVOPACK terminals.
 - Connect an AC power supply to the L1, L2, and L3 terminals and the L1C and L2C terminals on the SERVOPACK.
 - Connect a DC power supply to the B1/⊕ and ⊖2 terminals and the L1C and L2C terminals on the SERVOPACK.

There is a risk of failure or fire.
- Always specify a DC power supply input (Pn001 = n.□1□□) before you input DC power for the main circuit power supply.
If you input DC power without specifying a DC power supply input (i.e., without setting Pn001 to n.□1□□), the SERVOPACK's internal elements may burn and may cause fire or damage to the equipment.
- With a DC power supply input, time is required to discharge electricity after the main power supply is turned OFF. A high residual voltage may remain in the SERVOPACK after the power supply is turned OFF. Be careful not to get an electric shock.
- Install fuses on the power supply line if you use DC power.
- The Servomotor returns regenerative energy to the power supply. If you use a SERVOPACK with a DC power supply input, regenerative energy is not processed. Process the regenerative energy at the power supply.
- If you use a DC power supply input with any of the following SERVOPACKs, externally connect an inrush current limiting circuit and use the power ON and OFF sequences recommended by Yaskawa: SGD7S-330A, -470A, -550A, -590A, or -780A.
There is a risk of equipment damage.
Refer to the following section for the power ON and OFF sequences.
 4.3.3 Power ON Sequence on page 4-15

Refer to the following section for information on wiring the SERVOPACK.

 4.3.4 Power Supply Wiring Diagrams on page 4-17

5.2.2 Single-phase AC Power Supply Input/Three-phase AC Power Supply Input Setting

Some models of Three-phase 200-VAC SERVOPACKs can also operate on a single-phase 200-VAC power supply.

You can use a single-phase, 200-V power supply input with the following models.

- SGD7S-R70A, -R90A, -1R6A, -2R8A, and -5R5A

If you use a single-phase, 200-VAC power supply input for the SERVOPACK's main circuit power supply, set parameter Pn00B to n.□1□□ (Use a three-phase power supply input as a single-phase power supply input).

Information You do not need to change the setting of Pn00B to n.□1□□ (Use a three-phase power supply input as a single-phase power supply input) for a SERVOPACK with a single-phase 200-VAC power supply input (model numbers: SGD7S-120AE0A008) or for a SERVOPACK with a single-phase 100-VAC power supply input.

Parameter	Meaning	When Enabled	Classification
Pn00B	n.□0□□ (default setting)	After restart	Setup
	n.□1□□		



Important

1. If you use a single-phase power supply input without specifying a single-phase AC power supply (Pn00B = n.□1□□), an A.F10 alarm (Power Supply Line Open Phase) will occur.
2. Not all SERVOPACKs can be run on a single-phase AC power supply input. If you connect a single-phase AC power supply input to a SERVOPACK that does not support single-phase power, an A.F10 alarm (Power Supply Line Open Phase) will occur.
3. If you use a single-phase 200-VAC power supply input, the torque-motor speed characteristic of the Servomotor will not be the same as for a three-phase AC power supply input. Decide whether to use a single-phase or three-phase AC power supply input after checking the characteristics given in the Servomotor manual or catalog.

Refer to the following section for information on wiring a single-phase AC power supply input to the SERVOPACK.

 • *Wiring Example for Single-Phase, 200-VAC Power Supply Input* on page 4-18

5.3 Automatic Detection of Connected Motor

You can use a SERVOPACK to operate either a Rotary Servomotor or a Linear Servomotor. If you connect the Servomotor encoder to the CN2 connector on the SERVOPACK, the SERVOPACK will automatically determine which type of Servomotor is connected. Therefore, you normally do not need to specify the Servomotor type.

Information If an encoder is not connected, e.g., for a test without a motor, you can specify a Rotary Servomotor or a Linear Servomotor in Pn000 = n.X□□□ (Rotary/Linear Startup Selection When Encoder Is Not Connected). If you specify either a Rotary or Linear Servomotor, only the parameters, monitors, alarms, and functions for the specified motor type will be enabled.

	Parameter	Meaning	When Enabled	Classification
Pn000	n.0□□□ (default setting)	When an encoder is not connected, start as SERVOPACK for Rotary Servomotor.	After restart	Setup
	n.1□□□	When an encoder is not connected, start as SERVOPACK for Linear Servomotor.		

5.4 Motor Direction Setting

You can reverse the direction of Servomotor rotation by changing the setting of Pn000 = n.□□□X (Rotation Direction Selection) without changing the polarity of the speed or position reference. This causes the rotation direction of the Servomotor to change, but the polarity of the signals, such as encoder output pulses, output from the SERVOPACK do not change. Set the appropriate direction for your system.

Refer to the following section for details on the encoder divided pulse output.

 6.5 Encoder Divided Pulse Output on page 6-15

- Rotary Servomotors

The default setting for forward rotation is counterclockwise (CCW) as viewed from the load end of the Servomotor.

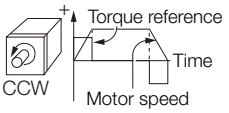
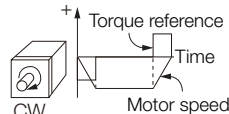
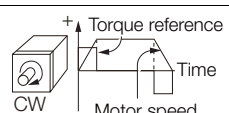
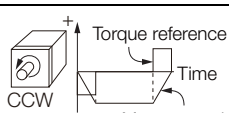
Parameter	Forward/Reverse Reference	Motor Direction and Encoder Divided Pulse Outputs	Applicable Overtravel Signal (OT)
Pn000	n.□□□0 Use CCW as the forward direction. (default setting)	Forward reference 	P-OT (Forward Drive Prohibit) signal
		Reverse reference 	N-OT (Reverse Drive Prohibit) signal
	n.□□□1 Use CW as the forward direction. (Reverse Rotation Mode)	Forward reference 	P-OT (Forward Drive Prohibit) signal
		Reverse reference 	N-OT (Reverse Drive Prohibit) signal

Note: The trace waveforms of the SigmaWin+ are shown in the above table for the torque reference and motor speed diagrams. If you measure them on a measuring instrument, e.g., with an analog monitor, the polarity will be reversed.

- Linear Servomotors

Before you set this parameter, make sure that Pn080 = n.□□X□ (Motor Phase Sequence Selection) is set correctly.

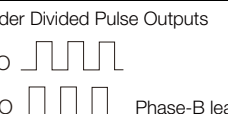
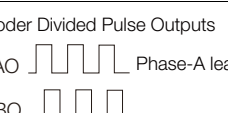
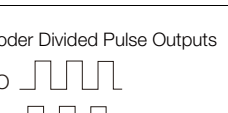
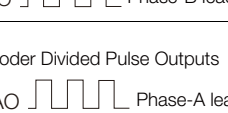
Parameter	Forward/Reverse Reference	Motor Moving Direction and Encoder Divided Pulse Outputs	Applicable Overtravel Signal (OT)
Pn000	n.□□□0 Use the direction in which the linear encoder counts up as the forward direction. (default setting)	Forward reference 	P-OT (Forward Drive Prohibit) signal
		Reverse reference 	N-OT (Reverse Drive Prohibit) signal
	n.□□□1 Use the direction in which the linear encoder counts down as the forward direction.	Forward reference 	P-OT (Forward Drive Prohibit) signal
		Reverse reference 	N-OT (Reverse Drive Prohibit) signal

Note: The trace waveforms of the SigmaWin+ are shown in the above table for the force reference and motor speed diagrams. If you measure them on a measuring instrument, e.g., with an analog monitor, the polarity will be reversed.

5.5 Setting the Linear Encoder Pitch

If you connect a linear encoder to the SERVOPACK through a Serial Converter Unit, you must set the scale pitch of the linear encoder in Pn282.

If a Serial Converter Unit is not connected, the setting of the Pn282 is disabled.



Term

Serial Converter Unit
The Serial Converter Unit converts the signal from the linear encoder into a form that can be read by the SERVOPACK.

Scale Pitch
A linear encoder has a scale for measuring lengths (positions). The length of one division on this scale is the scale pitch.

Pn282	Linear Encoder Pitch				
	Setting Range	Setting Unit	Default Setting	When Enabled	Classification
	0 to 6,553,600	0.01 μm	0	After restart	Setup

You will not be able to control the Linear Servomotor if Pn282 is not set correctly. Check the above table and always set the correct value before you operate the Linear Servomotor.

Type of Linear Encoder	Manufacturer	Model	Serial Converter Unit Model	Linear Encoder Pitch [μm]
Incremental	Dr. JOHANNES HEIDENHAIN GmbH	LIDA48□	JZDP-H003-□□□-E	20
			JZDP-J003-□□□-E	
		LIF48□	JZDP-H003-□□□-E	4
			JZDP-J003-□□□-E	
	Renishaw PLC	RGH22B	JZDP-H005-□□□-E	20
			JZDP-J005-□□□-E	
	TONIC series (Ti0000A00V only)	JZDP-H005-□□□-E	20	
		JZDP-J005-□□□-E		

The first time you supply power to the SERVOPACK, the panel display on the front of the Servomotor will display an A.080 alarm (Linear Encoder Pitch Setting Error). The A.080 alarm is displayed because the setting of Pn282 has not been changed. The A.080 alarm will be cleared when you change the setting of Pn282 and then turn the power supply OFF and ON again.

Information **Linear Encoder Pitch**
If you do not use a Serial Converter Unit, the linear encoder pitch is automatically set and the setting of the Pn282 is disabled. Refer to the following section for details.

 ■ *Feedback Resolution of Linear Encoder on page 5-44*

5.6

Writing Linear Servomotor Parameters

If you connect a linear encoder to the SERVOPACK without going through a Serial Converter Unit, you must use the SigmaWin+ to write the motor parameters to the linear encoder. The motor parameters contain the information that is required by the SERVOPACK to operate the Linear Servomotor.

You can download the motor parameters from our web site (<http://www.e-mechatronics.com/>).

! WARNING

- Check the Servomotor and linear encoder information before you write the motor parameters.

If you do not write the correct motor parameters, the Servomotor may run out of control or burning may occur, possibly resulting in equipment damage or fire.

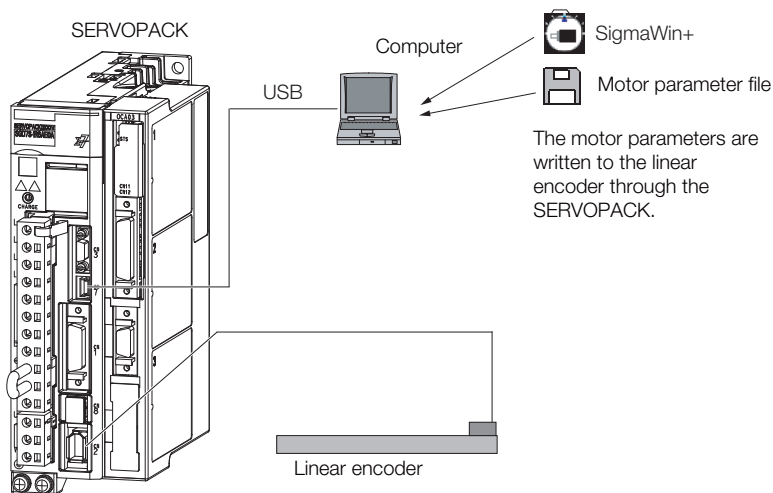

Important

Serial number information is not included in the motor parameters. You cannot use the monitor functions of the SERVOPACK to monitor the serial number.

If you attempt to monitor the serial number, ***** will be displayed.

Precautions

- If the encoder parameters are not written to the linear encoder, an A.CA0 alarm (Encoder Parameter Error) will occur. Consult the manufacturer of the linear encoder.
- If the motor parameters are not written to the linear encoder, an A.CA0 alarm (Encoder Parameter Error) will not occur, but the following alarms will occur.
A.040 (Parameter Setting Error), A.041 (Encoder Output Pulse Setting Error),
A.050 (Combination Error), A.051 (Unsupported Device Alarm),
A.550 (Maximum Speed Setting Error), A.710 (Instantaneous Overload),
A.720 (Continuous Overload), and A.C90 (Encoder Communications Error)

Applicable Tools

The following table lists the tools that you can use to write the parameters to the Linear Servomotor.

Tool	Fn No./Function Name	Reference
Digital Operator	You cannot write Linear Servomotor parameters from the Digital Operator.	
SigmaWin+	Encoder Setting – Motor Parameter Scale Write	Operating Procedure on page 5-18

Operating Procedure

Use the following procedure to write the motor parameters to the Linear Encoder.

1. Prepare the motor parameter file to write to the linear encoder.
2. Click the  Servo Drive Button in the workspace of the Main Window of the SigmaWin+.
3. Select **Motor Parameter Scale Write** in the Menu Dialog Box.
The Motor Parameter Scale Write Dialog Box will be displayed.
4. Click the **OK** Button.

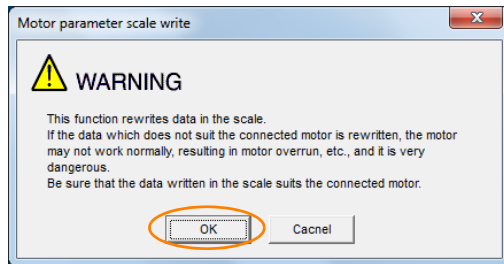

Click the **Cancel** Button to cancel writing the motor parameters to the linear encoder. The Main Window will return.

If the write is completed normally, the Motor Parameter Scale Write - File Select Dialog Box will be displayed.

5. Click the **Ref.** Button.

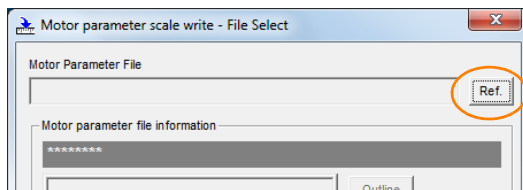

6. Select the motor parameter file that you prepared and click the **Open** Button.

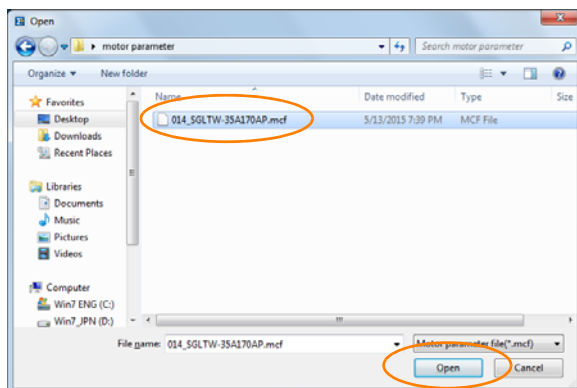

7. Confirm that the motor parameter file information that is displayed is suitable for your Servomotor, and then click the **Next Button**.

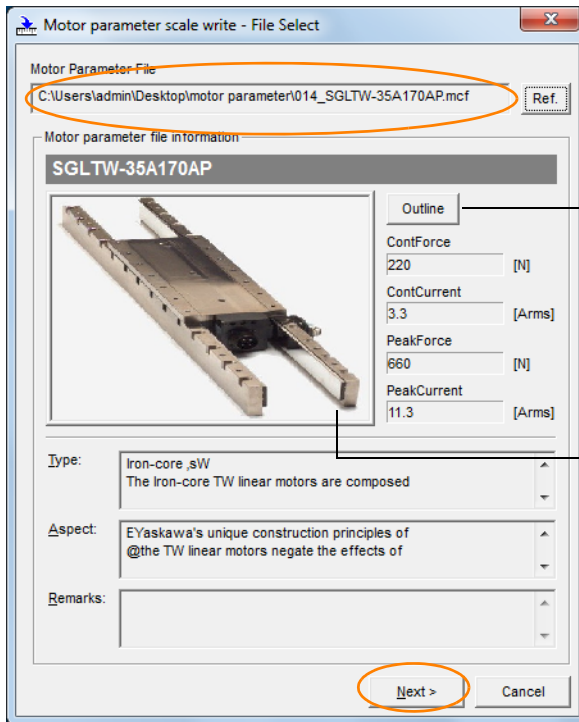

Displays an exterior view of the Servomotor.

Click the image to enlarge it.

Click the **Cancel** Button to cancel writing the motor parameters to the linear encoder. The Main Window will return.

8. Click the **Write Button**.

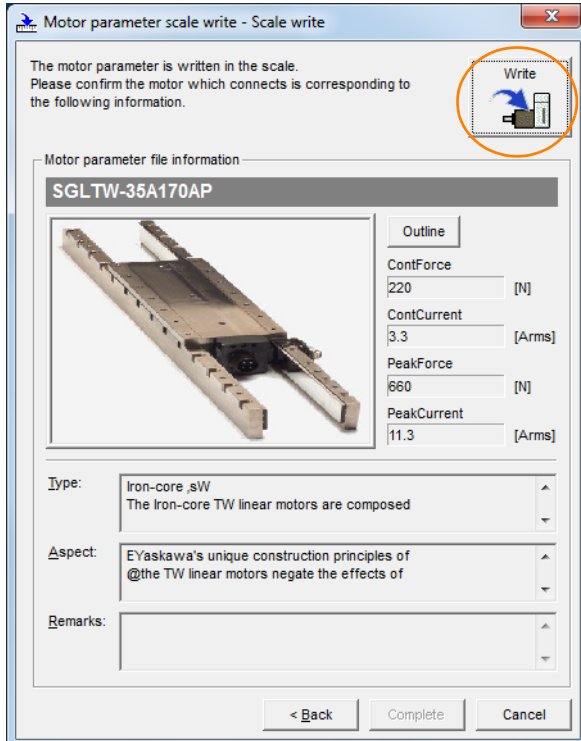

9. Click the **Yes Button**.

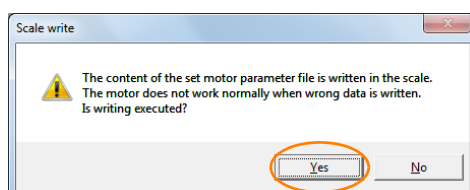

Click the **No** Button to cancel writing the motor parameters to the linear encoder.

If you click the **Yes** Button, writing the motor parameter scale will start.

10. Click the Complete Button.

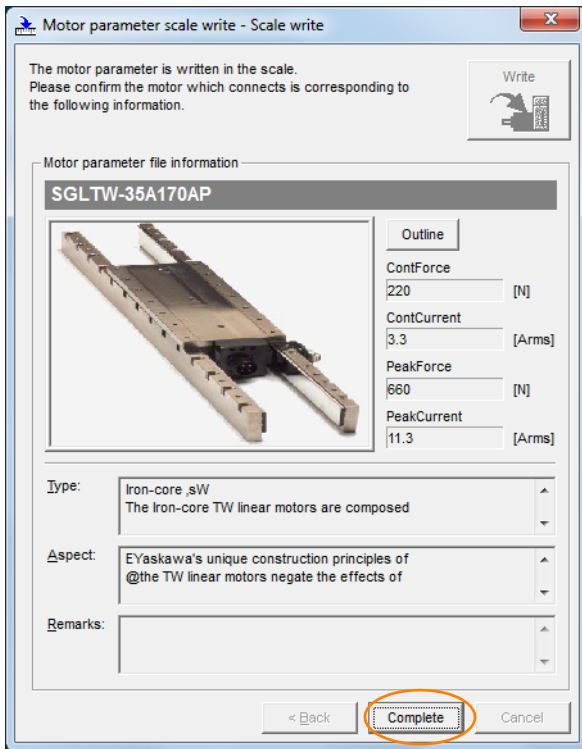

11. Click the OK Button.

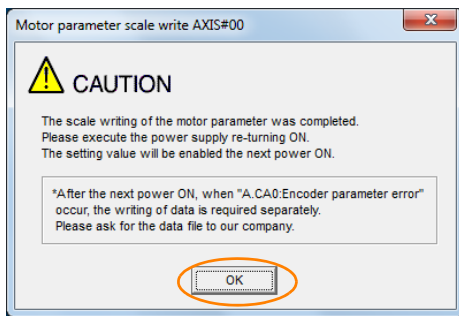

12. Turn the power supply to the SERVOPACK OFF and ON again.

This concludes the procedure to write the motor parameters.

Confirming If the Motor Parameters Have Been Written

After you write the motor parameters, you can use a monitor function to confirm that the motor parameters are in the encoder.

If the motor parameters have not been written, no information on the Servomotor will be displayed.

9.1 Monitoring Product Information on page 9-2

5.7

Selecting the Phase Sequence for a Linear Servomotor

You must select the phase sequence of the Linear Servomotor so that the forward direction of the Linear Servomotor is the same as the encoder's count-up direction.

Before you set the Linear Servomotor phase sequence (Pn080 = n.□□X□), check the following items.

- Confirm that the signal from the linear encoder is being received normally.
- Make sure that the forward direction of the Linear Servomotor and the count-up direction of the linear encoder are in the same direction.



If you do not confirm the above items before you attempt to operate the Servomotor, the Servomotor may not operate or it may run out of control. Always confirm these items before you operate the Servomotor.

Related Parameters

Parameter	Meaning	When Enabled	Classification
Pn080	n.□□0□ (default setting)	After restart	Setup
	n.□□1□		

Operating Procedure

Use the following procedure to select the phase sequence for a Linear Servomotor.

1. Set Pn000 to n.□□□0 (Set a phase-A lead as a phase sequence of U, V, and W).
This setting is to make following confirmation work easier to understand.
2. Select **Monitor** in the Menu Dialog Box.
The Operation Panel will be displayed so that you can check the feedback pulse counter.
To check the feedback pulse counter with the Digital Operator, use Un00D (Feedback Pulse Counter).
3. Manually move the Moving Coil from one end to the other of the stroke and confirm that only the correct number of feedback pulses is returned.
If the correct number and only the correct number of pulses is returned, the signal is being received correctly from the linear encoder.

Example

In this example, assume that a linear encoder with a scale pitch of 20 μm and a resolution of 256 is used. If you manually move the Moving Coil 1 cm in the count-up direction of the linear encoder, the number of feedback pulses would be as follows:
 $1 \text{ cm} / (20 \text{ μm} / 256) = 128,000 \text{ pulses}$

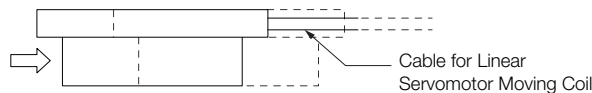

If there are 128,000 pulses on the feedback pulse counter after you manually move the Moving Coil in the direction of the cable, you have completed the confirmation.

Note: The actual monitor display will be offset by the error in the travel distance. There is no problem as long as the above value is close to the calculated value.

Information

If the correct value is not displayed for the feedback pulse counter, the following conditions may exist. Check the situation and correct any problems.

- The linear encoder pitch is not correct.
If the scale pitch that is set in Pn282 does not agree with the actual scale pitch, the expected number of feedback pulses will not be returned. Check the specifications of the linear encoder.
- The linear encoder is not adjusted properly.
If the linear encoder is not adjusted properly, the output signal level from the linear encoder will drop and the correct number of pulses will not be counted. Check the adjustment of the linear encoder. Contact the manufacturer of the linear encoder for details.
- There is a mistake in the wiring between the linear encoder and the Serial Converter Unit.
If the wiring is not correct, the correct number of pulses will not be counted. Correct the wiring.

4. Manually move the Moving Coil in the direction of the cable and check the value of the feedback pulse counter in the Operation Panel to confirm that it is counting up.

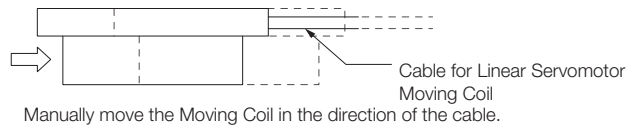

5. If the feedback pulse counter counts up, set a phase-A lead as a phase sequence of U, V, and W (Pn080 = n.□□0□).
If the feedback pulse counter counts down, set a phase-B lead as a phase sequence of U, V, and W (Pn080 = n.□□1□).
6. Turn the power supply to the SERVOPACK OFF and ON again.
7. If necessary, return Pn000 = n.□□□X (Direction Selection) to its original setting.

This concludes the procedure to set the phase sequence of the Linear Servomotor.

5.8 Polarity Sensor Setting

The polarity sensor detects the polarity of the Servomotor. You must set a parameter to specify whether the Linear Servomotor that is connected to the SERVOPACK has a polarity sensor. Specify whether there is a polarity sensor in Pn080 = n.□□□X (Polarity Sensor Selection).

If the Linear Servomotor has a polarity sensor, set Pn080 to n.□□□0 (Use polarity sensor) (default setting).

If the Linear Servomotor does not have a polarity sensor, set Pn080 to n.□□□1 (Do not use polarity sensor). Turn the power supply OFF and ON again to enable the new setting.

	Parameter	Meaning	When Enabled	Classification
Pn080	n.□□□0 (default setting)	Use polarity sensor.	After restart	Setup
	n.□□□1	Do not use polarity sensor.		

Information If you set Pn080 to n.□□□0 (Use polarity sensor) and the Linear Servomotor that is connected to the SERVOPACK does not have a polarity sensor, an A.C21 alarm (Polarity Sensor Error) will occur when you turn the power supply OFF and ON again.

5.9 Polarity Detection

If you use a Linear Servomotor that does not have a polarity sensor, then you must detect the polarity.

Detecting the polarity means that the position of the electrical angle phase on the electrical angle coordinates of the Servomotor is detected. The SERVOPACK cannot control the Servomotor correctly unless it accurately knows the position of the electrical angle coordinate of the Servomotor.

The execution timing and execution method for polarity detection depend on the encoder specification as described in the following table.

Encoder Specification	Polarity Detection Execution Timing	Polarity Detection Execution Method
Incremental encoder	Each time the control power supply to the SERVOPACK is turned ON (Even after you execute polarity detection, the position of the polarity will be lost the next time the control power supply to the SERVOPACK is turned OFF.)	<ul style="list-style-type: none"> • Use the /S-ON (Servo ON) signal. • Use the polarity detection function of the SigmaWin+. • Execute the Fn080 (Polarity Detection) utility function from the Digital Operator.
Absolute encoder	Only for initial setup, or after the SERVOPACK, linear encoder, or Servomotor has been replaced (The results of polarity detection is stored in the absolute encoder, so the polarity position is not lost when the control power supply is turned OFF.)	<ul style="list-style-type: none"> • Use the polarity detection function of the SigmaWin+. • Execute the Fn080 (Polarity Detection) utility function from the Digital Operator.

Information If you use a Linear Servomotor that does not have a polarity sensor, you will not be able to turn ON the servo until polarity detection has been completed.

5.9.1 Restrictions

Assumed Conditions

The Servomotor will move when you execute polarity detection. The following conditions must be met before you start.

- It must be OK to move the Moving Coil about 10 mm.
(If polarity detection fails, the Moving Coil may move approximately 5 cm. The amount of movement depends on conditions.)
- The linear encoder pitch must be 100 μm or less. (We recommend a pitch of 40 μm or less for an incremental encoder.)
- As much as possible, the motor must not be subjected to an imbalanced external force. (We recommend 5% or less of the rated force.)
- The mass ratio must be 50x or less.
- The axis must be horizontal.
- There must be friction equivalent to a few percent of the rated force applied to the guides. (Air sliders cannot be used.)

Preparations

Always check the following before you execute polarity detection.

- Not using a polarity sensor must be specified (Pn080 = n.□□□1).
- The servo must be OFF.
- The main circuit power supply must be ON.
- There must be no hard wire base block (HWBB).
- There must be no alarms except for an A.C22 alarm (Phase Information Disagreement).

- The parameters must not be write prohibited. (This item applies only when using the SigmaWin+ or Digital Operator.)
- The test without a motor function must be disabled (Pn00C = n.□□□0).
- There must be no overtravel.
- If the motor parameters have been written or the origin of the absolute linear encoder has been set, the power supply to the SERVOPACK must be turned OFF and ON again after completion of the writing or setting operation.



Important

1. Power is supplied to the Servomotor during polarity detection. Be careful not to get an electric shock. Also, the Moving Coil of the Linear Servomotor may greatly move during detection. Do not approach the moving parts of the Servomotor.
2. Polarity detection is affected by many factors. For example, polarity detection may fail if the mass ratio or friction is too large or the cable tension is too strong.

5.9.2 Using the /S-ON (Servo ON) Signal to Perform Polarity Detection

You can use the /S-ON (Servo ON) signal to perform polarity detection only with an incremental linear encoder.

Polarity detection will be performed when you turn the control power supply to the SERVOPACK OFF and then ON again, and then input the /S-ON signal. As soon as polarity detection is completed, the /S-RDY (Servo Ready) signal will turn ON.

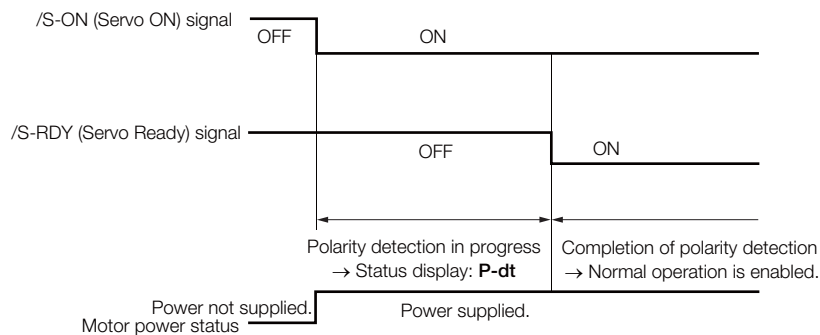

Type	Signal	Connector Pin No.	Signal Status	Meaning
Input	/S-ON	CN1-13	ON (closed)	The servo is turned ON (power is supplied to the motor), polarity detection is performed once, and then the servo is left ON. (The /S-RDY signal will turn ON.)
			OFF (open)	The servo is turned OFF (power is not supplied to the motor) and operation is disabled.



5.9.3 Using a Tool Function to Perform Polarity Detection

Applicable Tools

The following table lists the tools that you can use to perform polarity detection.

Tool	Fn No./Function Name	Reference
Digital Operator	Fn080	 Σ -7-Series Digital Operator Operating Manual (Manual No.: SIEP S800001 33)
SigmaWin+	<i>Encoder Setting – Polarity Detection</i>	 <i>Operating Procedure</i> on page 5-26

Operating Procedure

Use the following procedure to perform polarity detection.

1. Click the  Servo Drive Button in the workspace of the Main Window of the SigmaWin+.
2. Select **Polarity Detection** in the Menu Dialog Box.
The Polarity Detection Dialog Box will be displayed.
3. Click the **Continue** Button.

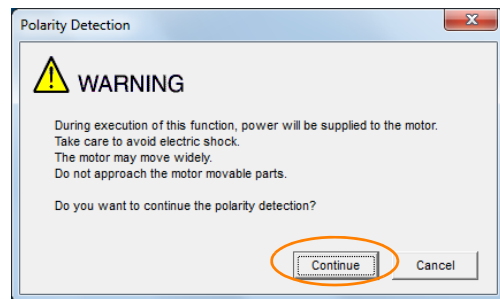

Click the **Cancel** Button to cancel polarity detection. The Main Window will return.

4. Click the **Start** Button.
Polarity detection will be executed.

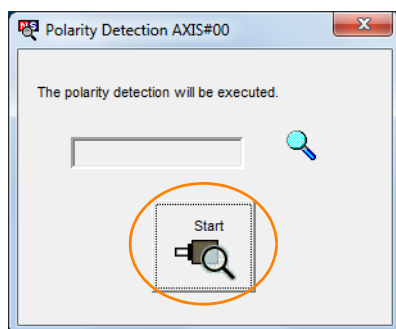

This concludes the polarity detection procedure.

5.10 Overtravel and Related Settings

Overtravel is a function of the SERVOPACK that forces the Servomotor to stop in response to a signal input from a limit switch that is activated when a moving part of the machine exceeds the safe range of movement.

The overtravel signals include the P-OT (Forward Drive Prohibit) and the N-OT (Reverse Drive Prohibit) signals.

You use the P-OT and N-OT signals to stop the machine by installing limit switches at the positions where you want to stop the machine that is operated by the Servomotor.

Even during overtravel, you can input a reference to drive the motor in the opposite direction.

A SERVOPACK wiring example is provided below.

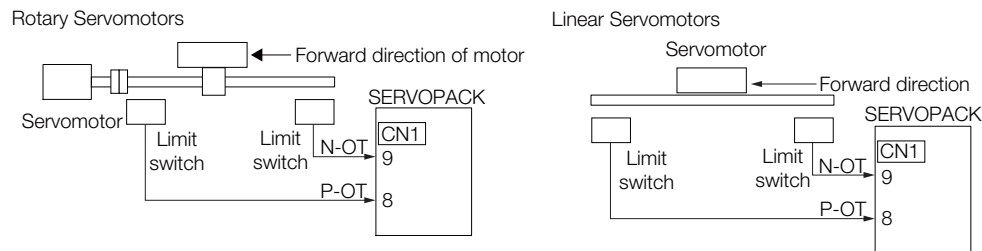

Using the overtravel function is not necessary for rotating applications such as rotary tables and conveyors. No wiring for overtravel input signals is required.

This section describes the parameters settings related to overtravel.

CAUTION

- To prevent accidents that may result from contact faults or disconnections, use normally closed limit switches. Do not change the default settings of the polarity of the overtravel signals (P-OT and N-OT).
- If you use a Servomotor for a vertical axis, the /BK (Brake) signal will remain ON (i.e., the brake will be released) when overtravel occurs. This may result in the workpiece falling when overtravel occurs. To prevent the workpiece from falling, set PnB1F to 1 or 2 so that the servo is locked when the Servomotor stops.
- A base block state is entered after stopping for overtravel. This may cause the Servomotor to be pushed back by an external force on the load shaft. To prevent the Servomotor from being pushed back, set PnB1F to 1 or 2 so that the servo is locked when the Servomotor stops.

5.10.1 Overtravel Signals

The overtravel signals include the P-OT (Forward Drive Prohibit) and the N-OT (Reverse Drive Prohibit) signals.

Type	Signal	Connector Pin No.	Signal Status	Meaning
Input	P-OT	CN1-8	ON	Forward drive is enabled (actual operation).
			OFF	Forward drive is prohibited (forward overtravel).
	N-OT	CN1-9	ON	Reverse drive is enabled (actual operation).
			OFF	Reverse drive is prohibited (reverse overtravel).

Even during overtravel, you can input a reference to drive the motor in the opposite direction.

5.10.2 Overtravel Settings

You can use the following parameters to set the input signals for overtravel.

Parameter		Meaning	When Enabled
PnB0F	0 (default setting)	When input signal is OFF (open), forward run is prohibited (forward overtravel).	After restart
	1	When input signal is ON (closed), forward run is prohibited (forward overtravel).	
	2	Forward run is always prohibited (forward overtravel).	
	3	Forward run is always enabled. (P-OT signal is not used.)	
PnB10	0 (default setting)	When input signal is OFF (open), reverse run is prohibited (reverse overtravel).	
	1	When input signal is ON (closed), reverse run is prohibited (reverse overtravel).	
	2	Reverse run is always prohibited (reverse overtravel).	
	3	Reverse run is always enabled. (N-OT signal is not used.)	

Note: During the overtravel state or software limit state, the servomotor is not positioned to the target position specified by the controller. Check the current position to confirm that the axis is stopped at a safe position.

5.10.3 Motor Stopping Method When Overtravel is Used

Set the following parameter to specify the motor stopping method when overtravel is used.

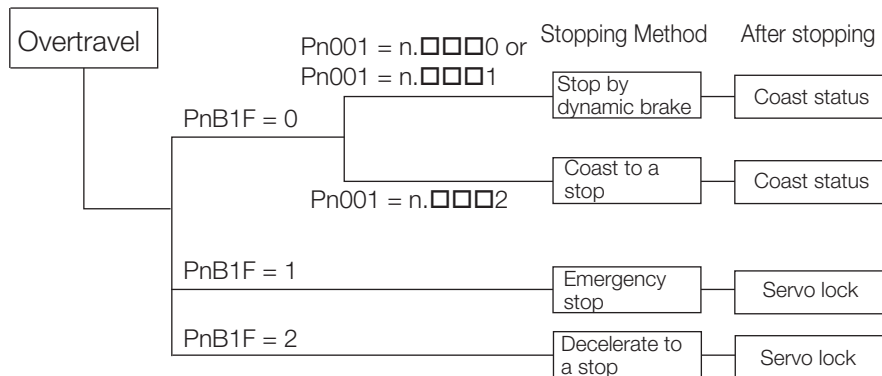

Parameter		Meaning	When Enabled
PnB1F	0 (default setting)	Stops the motor with the same method as when the servo is turned OFF (according to setting of Pn001 = n.□□□X).	After restart
	1	Stops motor immediately, and then changes motor state to servo lock.	
	2	Decelerates motor to a stop at deceleration rate set with PnB2B, and then changes motor state to servo lock.	

Set the deceleration rate when decelerating to a stop in PnB2B.

PnB2B	Deceleration			
	Setting Range	Setting Unit	Default Setting	When Enabled
	1 to 99999999*	1000 (Reference units/min) /ms	1000	Immediately

* If you set PnB54 to 1 (Enable Expansion Mode), the range will be 1 to 199,999,999. Refer to the following section for details.

 12.4 Speed/Position Expansion Function Setting on page 12-8



Important

If the servo turns OFF due to overtravel, the servo will not turn ON even if the overtravel is released. To turn ON the servo, turn the /S-ON signal OFF and then ON or send the SVON serial command. If parameter PnB0E is set to 2 to keep the /S-ON signal always ON, turn the power supply OFF and then ON again.

5.10.4 Overtravel Warnings

You can set the system to detect an A.9A0 warning (Overtravel) if overtravel occurs while the servo is ON. This allows the SERVOPACK to notify the host controller with a warning even when the overtravel signal is input only momentarily. An alarm occurs only if overtravel occurs while the servo is ON. An overtravel warning will not be detected when the servo is OFF, even if overtravel occurs.



Important

1. The occurrence of an A.9A0 warning will not stop the motor or have any affect on host controller motion operations. The next step (e.g., the next motion or command) can be executed even if an overtravel warning exists. However, depending on the processing specifications and programming for warnings in the host controller, operation may be affected when an overtravel warning occurs (e.g., motion may stop or not stop). Confirm the specifications and programming in the host controller.
2. When overtravel occurs, the SERVOPACK will perform stop processing for overtravel. Therefore, when an A.9A0 warning occurs, the Servomotor may not reach the target position specified by the host controller. Check the feedback position to make sure that the axis is stopped at a safe position.

The following parameter is set for this function.

Parameter	Meaning	When Enabled	Classification
Pn00D	n.0□□□ (default setting)	Immediately	Setup
	n.1□□□		

A timing chart for warning detection is provided below.

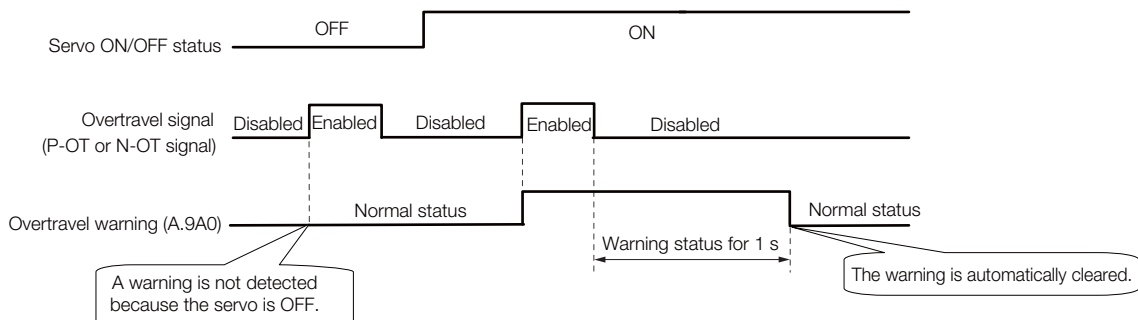

Information

1. Warnings are detected for overtravel in the same direction as the reference.
2. Warnings are not detected for overtravel in the opposite direction from the reference.
Example: A warning will not be output for a forward reference even if the N-OT signal turns ON.
3. A warning can be detected in either the forward or reverse direction if there is no reference.
4. A warning will not be detected when the servo is turned ON even if overtravel status exists.
5. The warning status will be held for one second after the overtravel status no longer exists and it will then be cleared automatically.

5.11 Holding Brake

A holding brake is used to hold the position of the moving part of the machine when the SERVOPACK is turned OFF so that moving part does not move due to gravity or an external force. You can use the brake that is built into a Servomotor with a Brake, or you can provide one on the machine.

The holding brake is used in the following cases.

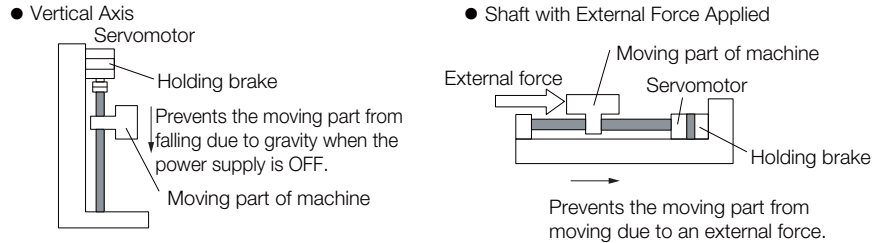

Important

- The brake built into a Servomotor with a Brake is a de-energization brake. It is used only to hold the Servomotor and cannot be used for braking. Use the holding brake only to hold a Servomotor that is already stopped.
- The /BK signal will remain ON during overtravel. The brake will not be applied.

5.11.1 Brake Operating Sequence

You must consider the brake release delay time and the brake operation delay time to determine the brake operation timing, as described below.

Term

Brake Release Delay Time
The time from when the /BK (Brake) signal is turned ON until the brake is actually released.

Brake Operation Delay Time
The time from when the /BK (Brake) signal is turned OFF until the brake actually operates.

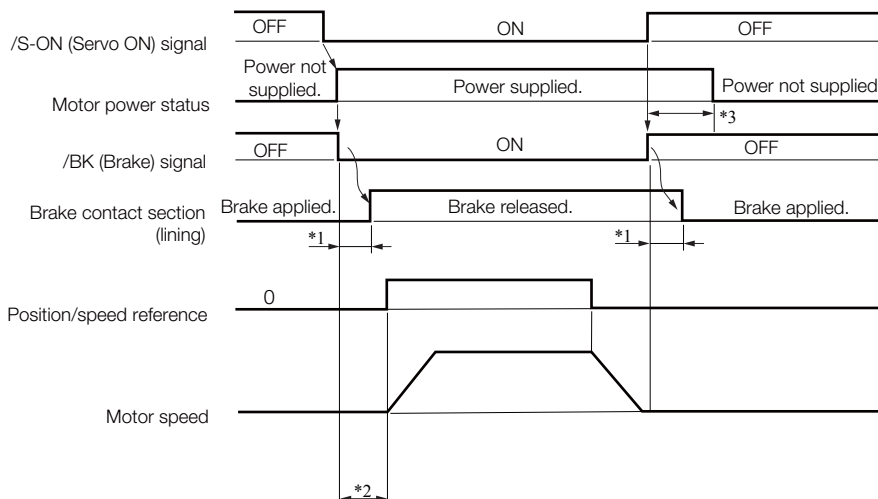

*1. Rotary Servomotors: The brake delay times for Servomotors with Holding Brakes are given in the following table. The operation delay times in the following table are examples for when the power supply is switched on the DC side. You must evaluate the actual brake delay times on the actual equipment before using the application.

Basic Functions That Require Setting before Operation

Model	Voltage	Brake Release Delay Time [ms]	Brake Operation Delay Time [ms]
SGM7M-A1 to -A3	24 VDC	60	100
SGM7J-A5 to -04			
SGM7J-06 and -08		80	
SGM7A-A5 to -04		60	
SGM7A-06 to -10		80	
SGM7A-15 to -25		170	80
SGM7A-30 to -50		100	
SGM7P-01		20	100
SGM7P-02 and -04		40	
SGM7P-08 and -15		20	
SGM7G-03 to -20		100	80
SGM7G-30 to -44		170	100
SGM7G-55 to -1A			80
SGM7G-1E		250	

Linear Servomotors: The brake delay times depend on the brake that you use. Set the parameters related to /BK signal output timing according to the delay times for the brake that you will actually use.

- *2. Before you output a reference from the host controller to the SERVOPACK, wait for at least 50 ms plus the brake release delay time after you send the SV_ON command.
- *3. Use the following parameters to set the timing of when the brake will operate and when the servo will be turned OFF.
 - Rotary Servomotors: Pn506 (Brake Reference-Servo OFF Delay Time), Pn507 (Brake Reference Output Speed Level), and Pn508 (Servo OFF-Brake Reference Waiting Time)
 - Linear Servomotors: Pn506 (Brake Reference-Servo OFF Delay Time), Pn508 (Servo OFF-Brake Reference Waiting Time), and Pn583 (Brake Reference Output Speed Level)

Connection Examples

Refer to the following section for information on brake wiring.

 4.4.4 Wiring the SERVOPACK to the Holding Brake on page 4-35

5.11.2 Allocating the /BK (Brake) Signal

The following settings are for the output signal that controls the brake.

The /BK signal is turned OFF (to operate the brake) when the servo is turned OFF or when an alarm is detected. You can adjust the timing of brake operation (i.e., the timing of turning OFF the /BK signal) with the servo OFF delay time (Pn506).

Type	Signal	Connector Pin No.	Signal Status	Meaning
Output	/BK	CN1-23, CN1-24 (default setting)	ON (closed)	Releases the brake.
			OFF (open)	Activates the brake.

Information The /BK signal will remain ON during overtravel. The brake will not be applied.

Allocating the /BK (Brake) Signal

The setting of the /BK signal can be changed with the parameters below.

Parameter	Meaning	When Enabled
PnB1D	0 (default setting)	When the /BK signal is ON (closed), the brake is released.
	1	
PnB51	0 (default setting)	Does not output /ALO1 to /ALO3. (/WARN, /BK, and /S-RDY are output.)
	1	



Inverting the polarity of the brake output signal (/BK), i.e. positive logic, will prevent the holding brake from working in case of its signal line disconnection. If this setting is absolutely necessary, check the operation and confirm that there are no safety problems.

5.11.3 Output Timing of /BK (Brake) Signal When the Servomotor Is Stopped

When the Servomotor is stopped, the /BK signal turns OFF at the same time as the /S-ON signal turns OFF. Use the servo OFF delay time (Pn506) to change the timing to turn OFF power supply to the motor after the /S-ON signal turns OFF.

Pn506	Brake Reference-Servo OFF Delay Time				
	Setting Range	Setting Unit	Default Setting	When Enabled	Classification
	0 to 50	10 ms	0	Immediately	Setup

- When the Servomotor is used to control a vertical axis, the machine moving part may move slightly due to gravity or an external force. You can eliminate this slight motion by setting the servo OFF delay time (Pn506) so that power supply to the motor is stopped after the brake is applied.
- This parameter sets the timing of stopping power supply to the Servomotor while the Servomotor is stopped.

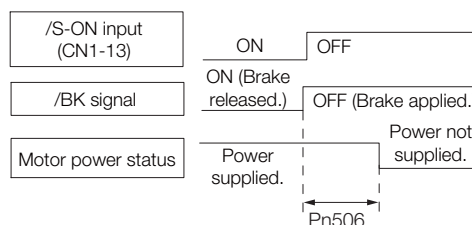



Power supply to the Servomotor will be stopped immediately when an alarm occurs, regardless of the setting of this parameter. The machine moving part may move due to gravity or an external force before the brake is applied.

5.11.4 Output Timing of /BK (Brake) Signal When the Servomotor Is Operating

If an alarm occurs while the Servomotor is operating, the Servomotor will start stopping and the /BK signal will be turned OFF. You can adjust the timing of /BK signal output by setting the brake reference output speed level (Rotary Servomotors: Pn507, Linear Servomotors: Pn583) and the servo OFF-brake reference waiting time (Pn508).

Note: If zero-speed stopping is set as the stopping method for alarms, the setting of Pn506 (Brake Reference-Servo OFF Delay Time) is used after the motor stops.

- Rotary Servomotors

Pn507	Brake Reference Output Speed Level				
	Setting Range	Setting Unit	Default Setting	When Enabled	Classification
	0 to 10,000	1 min ⁻¹	100	Immediately	Setup

Pn508	Servo OFF-Brake Reference Waiting Time				
	Setting Range	Setting Unit	Default Setting	When Enabled	Classification
	10 to 100	10 ms	50	Immediately	Setup

- Linear Servomotors

Pn583	Brake Reference Output Speed Level				
	Setting Range	Setting Unit	Default Setting	When Enabled	Classification
	0 to 10,000	1 mm/s	10	Immediately	Setup
Pn508	Servo OFF-Brake Reference Waiting Time				
	Setting Range	Setting Unit	Default Setting	When Enabled	Classification
	10 to 100	10 ms	50	Immediately	Setup

The brake operates when either of the following conditions is satisfied:

- When the Motor Speed Goes below the Level Set in Pn507 for a Rotary Servomotor or in Pn583 for a Linear Servomotor after the Power Supply to the Motor Is Stopped

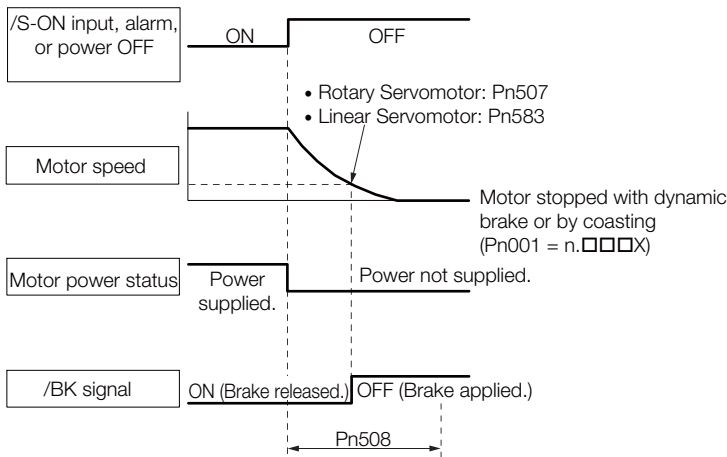

- When the Time Set In Pn508 Elapses after the Power Supply to the Motor Is Stopped

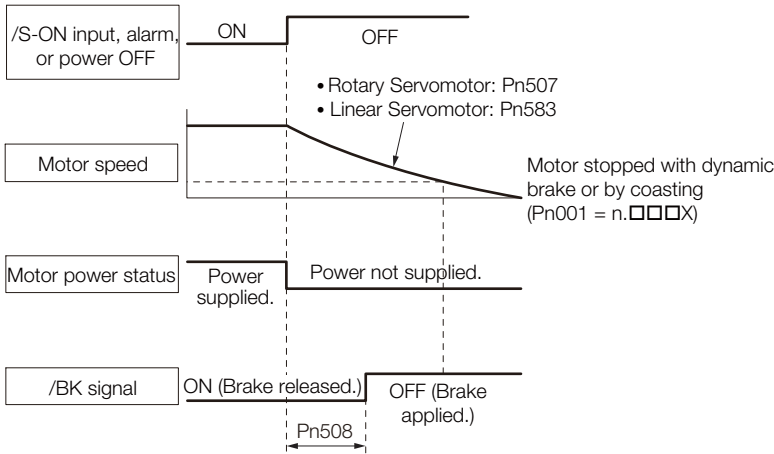

Important

The Servomotor will be limited to its maximum speed even if the brake reference output speed level (Rotary Servomotor: Pn507, Linear Servomotor: Pn583) is higher than the maximum speed.

5.12 Motor Stopping Methods for Servo OFF and Alarms

You can use the following methods to stop the Servomotor when the servo is turned OFF or an alarm occurs.

There are the following four stopping methods.

Motor Stopping Method	Meaning
Stopping by Applying the Dynamic Brake	The electric circuits are internally connected to stop the Servomotor quickly.
Coasting to a Stop	The motor stops naturally due to friction during operation.
Zero-speed Stopping	The speed reference is set to 0 to stop the Servomotor quickly.
Decelerating to a Stop	Emergency stop torque is used to decelerate the motor to a stop.

There are the following three conditions after stopping.

Status after Stopping	Meaning
Dynamic Brake Applied	The electric circuits are internally connected to hold the Servomotor.
Coasting	The SERVOPACK does not control the Servomotor. (The machine will move in response to a force from the load.)
Zero Clamping	A position loop is created and the Servomotor remains stopped at a position reference of 0. (The current stop position is held.)



Important

- The dynamic brake is used for emergency stops. The dynamic brake circuit will operate frequently if the power supply is turned ON and OFF or the servo is turned ON and OFF while a reference input is applied to start and stop the Servomotor. This may result in deterioration of the internal elements in the SERVOPACK. Use speed input references or position references to start and stop the Servomotor.
- If you turn OFF the main circuit power supply or control power supply during operation before you turn OFF the servo, the Servomotor stopping method depends on the SERVOPACK model as shown in the following table.

Condition	Servomotor Stopping Method	
	SGD7S-R70A, -1R6A, -2R8A, -3R8A, -5R5A, -7R6A, -120A, -180A, -200A, -R70F, -R90F, -2R1F, or -2R8F	SGD7S-330A, -470A, -550A, -590A, or -780A
Main circuit power supply turned OFF before turning OFF the servo	Stopping with dynamic brake	
Control power supply turned OFF before turning OFF the servo	Stopping with dynamic brake	Coasting to a stop

- If the Servomotor must be stopped by coasting rather than with the dynamic brake when the main circuit power supply or the control power supply is turned OFF before the servo is turned OFF, use a SERVOPACK with the Dynamic Brake Hardware Option.
- To minimize the coasting distance of the Servomotor to come to a stop when an alarm occurs, zero-speed stopping is the default method for alarms to which it is applicable. However, depending on the application, stopping with the dynamic brake may be more suitable than zero-speed stopping.
For example, when coupling two shafts (twin-drive operation), machine damage may occur if a zero-speed stopping alarm occurs for one of the coupled shafts and the other shaft stops with a dynamic brake. In such cases, change the stopping method to the dynamic brake.

5.12.1 Stopping Method for Servo OFF

Set the stopping method for when the servo is turned OFF in Pn001 = n.□□□X (Servo OFF or Alarm Group 1 Stopping Method).

Parameter		Servomotor Stopping Method	Status after Servomotor Stops	When Enabled	Classification
Pn001	n.□□□0 (default setting)	Dynamic brake*	Dynamic brake*	After restart	Setup
	n.□□□1		Coasting		
	n.□□□2	Coasting	Coasting		

* The Servomotor will coast to a stop when the SERVOPACK is not equipped with a built-in Dynamic Brake Resistor or an External Dynamic Brake Resistor is not connected.

Note: If Pn001 is set to n.□□□0 (Stop the motor by applying the dynamic brake) and the Servomotor is stopped or operates at a low speed, braking force may not be generated, just like it is not generated for coasting to a stop.

5.12.2 Servomotor Stopping Method for Alarms

There are two types of alarms, group 1 (Gr. 1) alarms and group 2 (Gr. 2) alarms. A different parameter is used to set the stopping method for alarms for each alarm type.

Refer to the following section to see which alarms are in group 1 and which are in group 2.

 15.2.1 List of Alarms on page 15-5

Motor Stopping Method for Group 1 Alarms

When a group 1 alarm occurs, the Servomotor will stop according to the setting of Pn001 = n.□□□X. The default setting is to stop by applying the dynamic brake.

Refer to the following section for details.

 5.12.1 Stopping Method for Servo OFF on page 5-36

Motor Stopping Method for Group 2 Alarms

When a group 2 alarm occurs, the Servomotor will stop according to the settings of the following three parameters. The default setting is for zero clamping.

- Pn001 = n.□□□X (Servo OFF or Alarm Group 1 Stopping Method)
- Pn00A = n.□□□X (Motor Stopping Method for Group 2 Alarms)
- Pn00B = n.□□X□ (Motor Stopping Method for Group 2 Alarms)

If you set Pn00B to n.□□1□ (Apply dynamic brake or coast Servomotor to a stop), you can use the same stopping method as group 1. If you are coordinating a number of Servomotors, you can use this stopping method to prevent machine damage that may result because of differences in the stopping method.

The following table shows the combinations of the parameter settings and the resulting stopping methods.

Parameter			Servomotor Stopping Method	Status after Servomotor Stops	When Enabled	Classification
Pn00B	Pn00A	Pn001				
n.□□□□ (default setting)	-	n.□□□□ (default setting)	Zero-speed stopping	Dynamic brake	After restart	Setup
		n.□□□□1		Coasting		
		n.□□□□2		Coasting		
n.□□1□	-	n.□□□□ (default setting)	Dynamic brake	Dynamic brake		
		n.□□□□1	Coasting	Coasting		
		n.□□□□2	Coasting	Coasting		
n.□□2□	n.□□□□0	n.□□□□ (default setting)	Dynamic brake	Dynamic brake		
		n.□□□□1	Coasting	Coasting		
		n.□□□□2	Coasting	Coasting		
	n.□□□□1 (default setting)	n.□□□□0 (default setting)	n.□□□□ (default setting)	Motor is decelerated using the torque set in Pn406 as the maximum torque.		
			n.□□□□1		Coasting	
			n.□□□□2		Coasting	
	n.□□□□2	n.□□□□ (default setting)	Coasting			
		n.□□□□1	Coasting			
		n.□□□□2	Coasting			
	n.□□□□3	n.□□□□0 (default setting)	n.□□□□ (default setting)	Motor is decelerated according to setting of Pn30A.	Dynamic brake	
			n.□□□□1		Coasting	
			n.□□□□2		Coasting	
n.□□□□4	n.□□□□ (default setting)	Coasting				
	n.□□□□1	Coasting				
	n.□□□□2	Coasting				

Note: 1. The setting of Pn00A is ignored if Pn00B is set to n.□□□□ or n.□□1□.

2. Refer to the following section for details on Pn406 (Emergency Stop Torque).

 *Stopping the Servomotor by Setting Emergency Stop Torque on page 5-37*

3. Refer to the following section for details on Pn30A (Deceleration Time for Servo OFF and Forced Stops).

 *Stopping the Servomotor by Setting the Deceleration Time on page 5-38*

Stopping the Servomotor by Setting Emergency Stop Torque

To stop the Servomotor by setting emergency stop torque, set Pn406 (Emergency Stop Torque).

If Pn00A = n.□□□X is set to 1 or 2, the Servomotor will be decelerated to a stop using the torque set in Pn406 as the maximum torque.

The default setting is 800%. This setting is large enough to allow you to operate the Servomotor at the maximum torque. However, the maximum emergency stop torque that you can actually use is the maximum torque of the Servomotor.

Pn406	Emergency Stop Torque				
	Setting Range	Setting Unit	Default Setting	When Enabled	Classification
	0 to 800	1%*	800	Immediately	Setup

* Set a percentage of the motor rated torque.

Stopping the Servomotor by Setting the Deceleration Time

To specify the Servomotor deceleration time and use it to stop the Servomotor, set Pn30A (Deceleration Time for Servo OFF and Forced Stops).

Pn30A	Deceleration Time for Servo OFF and Forced Stops				
	Setting Range	Setting Unit	Default Setting	When Enabled	Classification
	0 to 10,000	1 ms	0	Immediately	Setup

If you set Pn30A to 0, the Servomotor will be stopped with a zero speed.

The deceleration time that you set in Pn30A is the time to decelerate the Servomotor from the maximum motor speed.

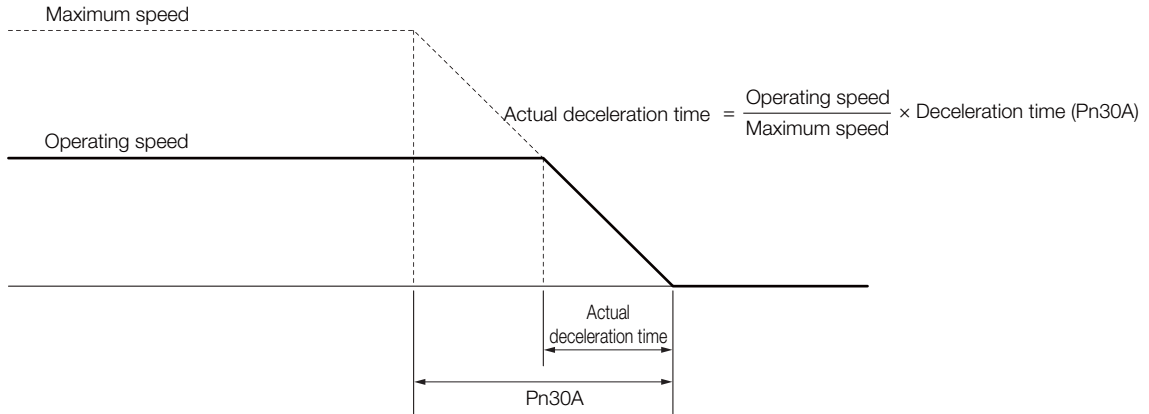

5.13 Motor Overload Detection Level

The motor overload detection level is the threshold used to detect overload alarms and overload warnings when the Servomotor is subjected to a continuous load that exceeds the Servomotor ratings.

It is designed to prevent Servomotor overheating.

You can change the detection timing for A.910 warnings (Overload) and A.720 alarms (Continuous Overload). You cannot change the detection level for A.710 alarms (Instantaneous Overload).

5.13.1 Detection Timing for Overload Warnings (A.910)

With the default setting for overload warnings, an overload warning is detected in 20% of the time required to detect an overload alarm. You can change the time required to detect an overload warning by changing the setting of the overload warning level (Pn52B). You can increase safety by using overload warning detection as an overload protection function matched to the system.

The following graph shows an example of the detection of overload warnings when the overload warning level (Pn52B) is changed from 20% to 50%. An overload warning is detected in half of the time required to detect an overload alarm.

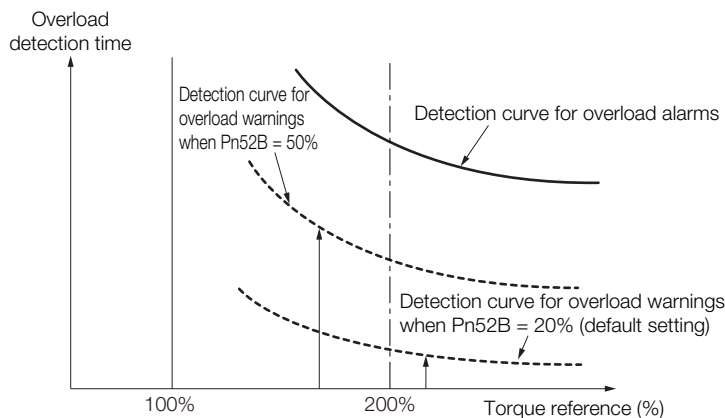

Pn52B	Overload Warning Level				
	Setting Range	Setting Unit	Default Setting	When Enabled	Classification
	1 to 100	1%	20	Immediately	Setup

5.13.2 Detection Timing for Overload Alarms (A.720)

If Servomotor heat dissipation is insufficient (e.g., if the heat sink is too small), you can lower the overload alarm detection level to help prevent overheating.

To reduce the overload alarm detection level, change the setting of Pn52C (Base Current Derating at Motor Overload Detection).

Pn52C	Base Current Derating at Motor Overload Detection				
	Setting Range	Setting Unit	Default Setting	When Enabled	Classification
	10 to 100	1%	100	After restart	Setup

An A.720 alarm (Continuous Overload) can be detected earlier to protect the Servomotor from overloading.

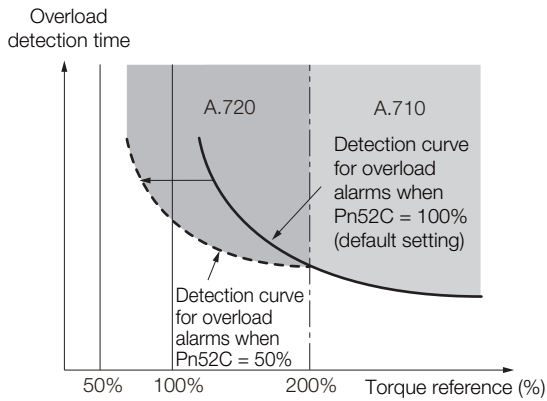

Note: The gray areas in the above graph show where A.710 and A.720 alarms occur.

Refer to the relevant manual given below for a diagram that shows the relationships between the Servomotor heat dissipation conditions (heat sink size, surrounding air temperature, and derating). You can protect the Servomotor from overloads more effectively by setting this derating value in Pn52C.

- 📖 Σ -7-Series Rotary Servomotor Product Manual (Manual No.: SIEP S800001 36)
- 📖 Σ -7-Series Linear Servomotor Product Manual (Manual No.: SIEP S800001 37)
- 📖 Σ -7-Series Direct Drive Servomotor Product Manual (Manual No.: SIEP S800001 38)

5.14 Electronic Gear Settings

The minimum unit of the position data that is used to move a load is called the reference unit. The reference unit is used to give travel amounts, not in pulses, but rather in distances or other physical units (such as μm or $^\circ$) that are easier to understand.

The electronic gear is used to convert the travel distances that are specified in reference units to pulses, which are required for actual movements.

With the electronic gear, one reference unit is equal to the workpiece travel distance per reference pulse input to the SERVOPACK. In other words, if you use the SERVOPACK's electronic gear, pulses can be read as reference units.

Note: If you set an electronic gear in the host controller, normally set the electronic gear ratio in the SERVOPACK to 1:1.

The difference between using and not using the electronic gear is shown below.

• Rotary Servomotors

In this example, the following machine configuration is used to move the workpiece 10 mm.

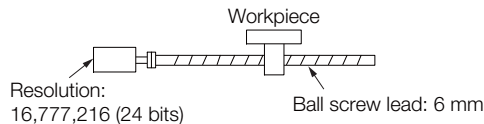

When the Electronic Gear Is Not Used

To move a workpiece 10 mm:
 ① Calculate the number of revolutions.
 The Servomotor will move 6 mm for each revolution, so $10/6$ revolutions are required to move 10 mm.
 ② Calculate the required number of reference pulses.
 One revolution is 16,777,216 pulses, therefore $10/6 \times 16,777,216 = 27,962,026.66$ pulses.
 ③ Input 27,962,027 pulses as the reference.

Calculating the number of reference pulses for each reference is troublesome.

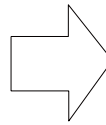

When the Electronic Gear Is Used

If you use reference units to move the workpiece when one reference unit is set to $1 \mu\text{m}$, the travel distance is $1 \mu\text{m}$ per pulse.
 To move the workpiece 10 mm ($10,000 \mu\text{m}$), $10,000 \div 1 = 10,000$ pulses, so 10,000 pulses would be input.

Calculating the number of reference pulses for each reference is not necessary.

• Linear Servomotors

In this example, the following machine configuration is used to move the load 10 mm. We'll assume that the scale pitch of the linear encoder is $20 \mu\text{m}$ and that the resolution of the serial converter unit is 256.

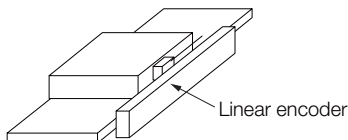

When the Electronic Gear Is Not Used

To move the load 10 mm:
 $10 \times 1000 \div 20 \times 256 = 128,000$ pulses, so 128,000 pulses are input as the reference.

Calculating the number of reference pulses for each reference is troublesome.

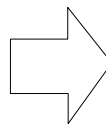

When the Electronic Gear Is Used

To use reference units to move the load 10 mm:
 If we set the reference unit to $1 \mu\text{m}$, the travel distance is $1 \mu\text{m}$ per pulse. To move the load 10 mm ($10,000 \mu\text{m}$), $10,000/1 = 10,000$ pulses, so 10,000 pulses would be input as the reference.

Calculating the number of reference pulses for each reference is not necessary.

5.14.1 Electronic Gear Ratio Settings

Set the electronic gear ratio using Pn20E and Pn210.



Important

The setting range of the electronic gear depends on the setting of Pn040 = n.□□X□ (Encoder Resolution Compatibility Selection).

- Pn040 = n.□□0□ (Use the encoder resolution of the Servomotor.)
Set the electronic gear ratio within the following range.
 $0.001 \leq \text{Electronic gear ratio (B/A)} \leq 64,000$
If the electronic gear ratio is outside of this range, an A.040 alarm (Parameter Setting Error) will occur.
- Pn040 = n.□□1□ (Use a resolution of 20 bits when connected to an SGM7J, SGM7A, SGM7P, SGM7G, SGM7E, or SGM7F Servomotor.)
Set the electronic gear ratio within the following range.
 $0.001 \leq \text{Electronic gear ratio (B/A)} \leq 4,000$
If the electronic gear ratio is outside of this range, an A.040 alarm (Parameter Setting Error) will occur.

Pn20E	Electronic Gear Ratio (Numerator)				
	Setting Range	Setting Unit	Default Setting	When Enabled	Classification
	1 to 1,073,741,824	1	64	After restart	Setup
Pn210	Electronic Gear Ratio (Denominator)				
	Setting Range	Setting Unit	Default Setting	When Enabled	Classification
	1 to 1,073,741,824	1	1	After restart	Setup

Calculating the Settings for the Electronic Gear Ratio

◆ Rotary Servomotors

If the gear ratio between the Servomotor shaft and the load is given as n/m, where n is the number of load rotations for m Servomotor shaft rotations, the settings for the electronic gear ratio can be calculated as follows:

$$\text{Electronic gear ratio } \frac{B}{A} = \frac{\text{Pn20E}}{\text{Pn210}} = \frac{\text{Encoder resolution}}{\text{Travel distance per load shaft revolution (reference units)}} \times \frac{m}{n}$$

Encoder Resolution

You can check the encoder resolution in the Servomotor model number.

SGM7M -□□□□□□

Code	Specification	Encoder Resolution
3	20-bit multiturn absolute encoder	1,048,576

SGM7J, SGM7A,
SGM7P, SGM7G -□□□□□□

Code	Specification	Encoder Resolution
6	24-bit batteryless multiturn absolute encoder	16,777,216
7	24-bit multiturn absolute encoder	16,777,216
F	24-bit incremental encoder	16,777,216

SGM7E, SGM7F -□□□□□□

Code	Specification	Encoder Resolution
7	24-bit multiturn absolute encoder	16,777,216
F	24-bit incremental encoder	16,777,216

SGMCS -□□□□□□

Code	Specification	Encoder Resolution
3	20-bit single-turn absolute encoder	1,048,576
D	20-bit incremental encoder	1,048,576

SGMCV -□□□□□□

Code	Specification	Encoder Resolution
E	22-bit single-turn absolute encoder	4,194,304
I	22-bit multiturn absolute encoder	4,194,304

Linear Servomotors

You can calculate the settings for the electronic gear ratio with the following equation:

When Not Using a Serial Converter Unit

Use the following formula if the linear encoder and SERVOPACK are connected directly or if a linear encoder that does not require a Serial Converter Unit is used.

$$\text{Electronic gear ratio } \frac{B}{A} = \frac{Pn20E}{Pn210} = \frac{\text{Travel distance per reference unit (reference units)} \times \text{Linear encoder resolution}}{\text{Linear encoder pitch (the value from the following table)}}$$

When Using a Serial Converter Unit

$$\text{Electronic gear ratio } \frac{B}{A} = \frac{Pn20E}{Pn210} = \frac{\text{Travel distance per reference unit (reference units)} \times \text{Resolution of the Serial Converter Unit}}{\text{Linear encoder pitch (setting of Pn282)}}$$

■ Feedback Resolution of Linear Encoder

The linear encoder pitches and resolutions are given in the following table.

Calculate the electronic gear ratio using the values in the following table.

Type of Linear Encoder	Manufacturer	Linear Encoder Model	Linear Encoder Pitch [μm] ^{*1}	Relay Device Model between SERVOPACK and Linear Encoder	Resolution	Resolution
Incremental	Dr. JOHANNES HEIDENHAIN GmbH	LIDA48□	20	JZDP-H003-□□□-E ^{*2}	256	0.078 μm
				JZDP-J003-□□□-E ^{*2}	4,096	0.0049 μm
		LIF48□	4	JZDP-H003-□□□-E ^{*2}	256	0.016 μm
				JZDP-J003-□□□-E ^{*2}	4,096	0.00098 μm
	Renishaw PLC	RGH22B	20	JZDP-H005-□□□-E ^{*2}	256	0.078 μm
				JZDP-J005-□□□-E ^{*2}	4,096	0.0049 μm
		TONIC series (Ti0000A00V only)	20	JZDP-H005-□□□-E ^{*2}	256	0.078 μm
				JZDP-J005-□□□-E ^{*2}	4,096	0.0049 μm
	Magnescale Co., Ltd.	SR75-□□□□□LF ^{*6}	80	–	8,192	0.0098 μm
		SR75-□□□□□MF	80	–	1,024	0.078 μm
		SR85-□□□□□LF ^{*6}	80	–	8,192	0.0098 μm
		SR85-□□□□□MF	80	–	1,024	0.078 μm
		SL700 ^{*6} , SL710 ^{*6} , SL720 ^{*6} , SL730 ^{*6}	800	PL101-RY ^{*3}	8,192	0.0977 μm
				MJ620-T13 ^{*4}		
	SQ10	400	MQ10-FLA ^{*4}	8,192	0.0488 μm	
			MQ10-GLA ^{*4}			
Canon Precision Inc.	PH03-36110	128	–	2,048	0.0625 μm	
	PH03-36120	128	–	2,048	0.0625 μm	

Continued on next page.

Continued from previous page.

Type of Linear Encoder	Manufacturer	Linear Encoder Model	Linear Encoder Pitch [μm]*1	Relay Device Model between SERVOPACK and Linear Encoder	Resolution	Resolution
Absolute	Dr. JOHANNES HEIDENHAIN GmbH	LIC4100 Series*7	20.48	EIB3391Y*5	4,096	0.005 μm
		LIC2100 Series*7	204.8	EIB3391Y*5	4,096	0.05 μm
			409.6	EIB3391Y*5	4,096	0.1 μm
		LIC4190 Series	40.96	–	4,096	0.01 μm
			20.48	–	4,096	0.005 μm
			4.096	–	4,096	0.001 μm
		LIC3190 Series	40.96	–	4,096	0.01 μm
		LIC2190 Series	409.6	–	4,096	0.1 μm
	204.8		–	4,096	0.05 μm	
	LC115	40.96	EIB3391Y*5	4,096	0.01 μm	
	LC415	40.96	EIB3391Y*5	4,096	0.01 μm	
	RSF Elektronik GmbH	MC15Y Series	409.6	–	4,096	0.1 μm
			204.8	–	4,096	0.05 μm
	Mitutoyo Corporation	ST781A/ST781AL	256	–	512	0.5 μm
		ST782A/ST782AL	256	–	512	0.5 μm
		ST783/ST783AL	51.2	–	512	0.1 μm
		ST784/ST784AL	51.2	–	512	0.1 μm
		ST788A/ST788AL	51.2	–	512	0.1 μm
		ST789A/ST789AL	25.6	–	512	0.05 μm
		ST1381	5.12	–	512	0.01 μm
	ST1382	0.512	–	512	0.001 μm	
	Renishaw PLC	EL36Y□□050F□□□	12.8	–	256	0.05 μm
		EL36Y□□100F□□□	25.6	–	256	0.1 μm
		EL36Y□□500F□□□	128	–	256	0.5 μm
		RL36Y□□050□□□□	12.8	–	256	0.05 μm
		RL36Y□□001□□□□	0.256	–	256	0.001 μm
	RLS d.o.o.	LA11YA Series	2,000	–	2,048	0.9765 μm
			2,000	–	4,096	0.4882 μm
			2,000	–	8,192	0.2441 μm
	Magnescale Co., Ltd.	SR77-□□□□□LF*6	80	–	8,192	0.0098 μm
		SR77-□□□□□MF	80	–	1,024	0.078 μm
		SR87-□□□□□LF*6	80	–	8,192	0.0098 μm
SR87-□□□□□MF		80	–	1,024	0.078 μm	
SQ47/SQ57-□□□□□SF□□□		20.48	–	4,096	0.005 μm	
SQ47/SQ57-□□□□□TF□□□		20.48	–	4,096	0.005 μm	
SQ47/SQ57-□□□□□AF□□□	40.96	–	4,096	0.01 μm		
SQ47/SQ57-□□□□□FF□□□	40.96	–	4,096	0.01 μm		

Continued on next page.

Continued from previous page.

Type of Linear Encoder	Manufacturer	Linear Encoder Model	Linear Encoder Pitch [μm]*1	Relay Device Model between SERVOPACK and Linear Encoder	Resolution	Resolution
Absolute	Fagor Automation S. Coop.	L2AK208	20	–	256	0.078 μm
		L2AK211	20	–	2,048	0.0098 μm
		LAK209	40	–	512	0.078 μm
		LAK212	40	–	4,096	0.0098 μm
		S2AK208	20	–	256	0.078 μm
		SV2AK208	20	–	256	0.078 μm
		G2AK208	20	–	256	0.078 μm
		S2AK211	20	–	2,048	0.0098 μm
		SV2AK211	20	–	2,048	0.0098 μm
		G2AK211	20	–	2,048	0.0098 μm
	Canon Precision Inc.	PH03-36E00	128	–	2,048	0.0625 μm

*1. These are reference values for setting SERVOPACK parameters. Contact the manufacturer for actual linear encoder scale pitches.

*2. This is the model of the Serial Converter Unit.

*3. This is the model of the Head with Interpolator.

*4. This is the model of the Interpolator.

*5. This is the model of the Interface Unit.

*6. If you use an encoder pulse output with this linear encoder, the setting range of the encoder output resolution (Pn281) is restricted. Refer to the following section for details on the encoder output resolution (Pn281).

 **6.5.2 Setting for the Encoder Divided Pulse Output on page 6-20**

*7. Sales of the interface unit EIB3391Y with the LIC4100 and LIC2100 series have ended due to the release of the LIC4190, LIC3190, and LIC2190 series.

Information

Resolution

You can calculate the resolution that is used inside the SERVOPACK (i.e., the travel distance per feedback pulse) with the following formula.

$$\text{Resolution (travel distance per feedback pulse)} = \frac{\text{Linear encoder pitch}}{\text{Resolution of Serial Converter Unit or linear encoder}}$$

The SERVOPACK uses feedback pulses as the unit to control a Servomotor.

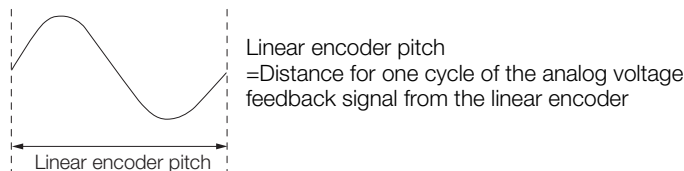

5.14.2 Electronic Gear Ratio Setting Examples

Setting examples are provided in this section.

- Rotary Servomotors

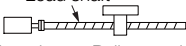
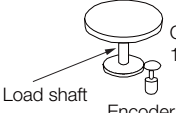
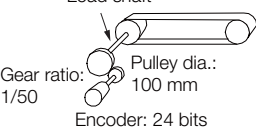
Step	Description	Machine Configuration		
		Ball Screw	Rotary Table	Belt and Pulley
		Reference unit: 0.001 mm Load shaft  Encoder: 24 bits Ball screw lead: 6 mm	Reference unit: 0.01°  Gear ratio: 1/100 Encoder: 24 bits	Reference unit: 0.005 mm Load shaft  Gear ratio: 1/50 Pulley dia.: 100 mm Encoder: 24 bits
1	Machine Specifications	<ul style="list-style-type: none"> • Ball screw lead: 6 mm • Gear ratio: 1/1 	<ul style="list-style-type: none"> • Rotation angle per revolution: 360° • Gear ratio: 1/100 	<ul style="list-style-type: none"> • Pulley dia.: 100 mm (Pulley circumference: 314 mm) • Gear ratio: 1/50
2	Encoder Resolution	16,777,216 (24 bits)	16,777,216 (24 bits)	16,777,216 (24 bits)
3	Reference Unit	0.001 mm (1 μm)	0.01°	0.005 mm (5 μm)
4	Travel Distance per Load Shaft Revolution (Reference Units)	6 mm/0.001 mm = 6,000	360°/0.01° = 36,000	314 mm/0.005 mm = 62,800
5	Electronic Gear Ratio	$\frac{B}{A} = \frac{16,777,216}{6,000} \times \frac{1}{1}$	$\frac{B}{A} = \frac{16,777,216}{36,000} \times \frac{100}{1}$	$\frac{B}{A} = \frac{16,777,216}{62,800} \times \frac{50}{1}$
6	Parameters	Pn20E: 16,777,216	Pn20E: 167,772,160	Pn20E: 838,860,800
		Pn210: 6,000	Pn210: 3,600	Pn210: 62,800

- Linear Servomotors

A setting example for a Serial Converter Unit resolution of 256 is given below.

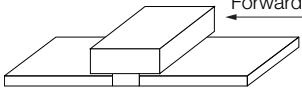
Step	Description	Machine Configuration
		Reference unit: 0.02 mm (20 μm)  Forward direction
1	Linear encoder pitch	0.02 mm (20 μm)
2	Reference Unit	0.001 mm (1 μm)
3	Electronic Gear Ratio	$\frac{B}{A} = \frac{1 (\mu\text{m})}{20 (\mu\text{m})} \times 256$
4	Setting Parameters	Pn20E: 256
		Pn210: 20

5.15 Resetting the Absolute Encoder

In a system that uses an absolute encoder, the multiturn data must be reset at startup. An alarm related to the absolute encoder (A.810 or A.820) will occur when the absolute encoder must be reset, such as when the power supply is turned ON.

When you reset the absolute encoder, the multiturn data is reset and any alarms related to the absolute encoder are cleared.

Reset the absolute encoder in the following cases.

- When an A.810 alarm (Encoder Backup Alarm) occurs
- When an A.820 alarm (Encoder Checksum Alarm) occurs
- When starting the system for the first time
- When you want to reset the multiturn data in the absolute encoder
- When the Servomotor has been replaced



CAUTION

- The multiturn data will be reset to a value between -2 and +2 rotations when the absolute encoder is reset. The reference position of the machine system will change. Adjust the reference position in the host controller to the position that results from resetting the absolute encoder.

If the machine is started without adjusting the position in the host controller, unexpected operation may cause personal injury or damage to the machine.

Information

1. The multiturn data will always be zero in the following cases. It is never necessary to reset the absolute encoder in these cases. An alarm related to the absolute encoder (A.810 or A.820) will not occur.
 - When you use a single-turn absolute encoder
 - When the encoder is set to be used as a single-turn absolute encoder (Pn002 = n.□2□□)
2. If a batteryless absolute encoder is used, an A.810 alarm (Encoder Backup Alarm) will occur the first time the power is turned ON. After you reset the absolute encoder, the A.810 alarm will no longer occur.

5.15.1 Precautions on Resetting

- You cannot use the /ALM-RST (Alarm Reset) signal from the SERVOPACK to clear the A.810 alarm (Encoder Backup Alarm) or the A.820 alarm (Encoder Checksum Alarm). Always execute the operation to reset the absolute encoder to clear these alarms.
- If an A.8□□ alarm (Internal Encoder Monitoring Alarm) occurs, turn OFF the power supply to reset the alarm.
- Confirm that setup (initialization) is not in progress from any other tool.



5.15.2 Preparations

Always check the following before you reset an absolute encoder.

- The parameters must not be write prohibited.
- The servo must be OFF to reset the absolute encoder.

5.15.3 Applicable Tools

The following table lists the tools that you can use to reset the absolute encoder.

Tool	Fn No./Function Name	Reference
Digital Operator	Fn008	 Σ -7-Series Digital Operator Operating Manual (Manual No.: SIEP S800001 33)
SigmaWin+	Encoder Setting – Reset Absolute Encoder	 5.15.4 Operating Procedure on page 5-49
Serial command communications	ABSPGRES utility command	 Monitor and Utility Function Commands on page 14-32

5.15.4 Operating Procedure

Use the following procedure to reset the absolute encoder.

1. Confirm that the servo is OFF.
2. Click the  Servo Drive Button in the workspace of the Main Window of the SigmaWin+.
3. Select **Absolute Encoder Reset** in the Menu Dialog Box.
The Absolute Encoder Reset Dialog Box will be displayed.
4. Click the **Continue** Button.

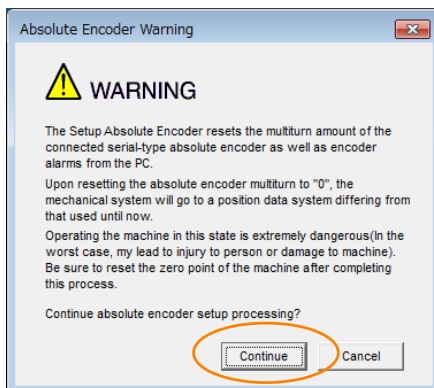

Click the **Cancel** Button to cancel resetting the absolute encoder. The Main Window will return.

5. Click the **Execute setting** Button.

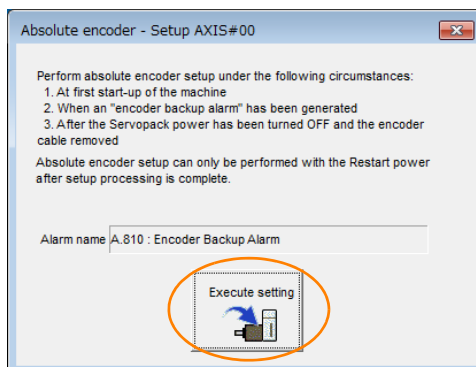

The current alarm code and name will be displayed in the **Alarm name** Box.

6. Click the **Continue** Button.

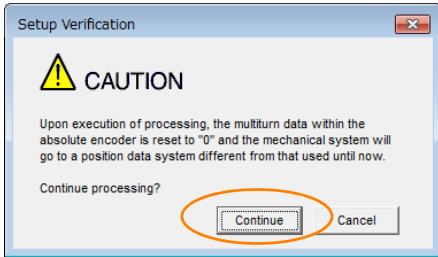

Click the **Cancel** Button to cancel resetting the absolute encoder. The previous dialog box will return.

7. Click the **OK** Button.

The absolute encoder will be reset.

When Resetting Fails

If you attempted to reset the absolute encoder when the servo was ON in the SERVOPACK, the following dialog box will be displayed and processing will be canceled.

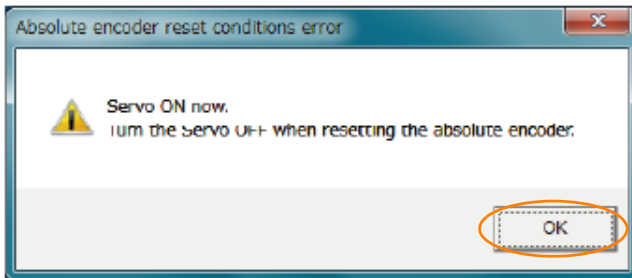

Click the **OK** Button. The Main Window will return. Turn OFF the servo and repeat the procedure from step 1.

When Resetting Is Successful

The following dialog box will be displayed when the absolute encoder has been reset.

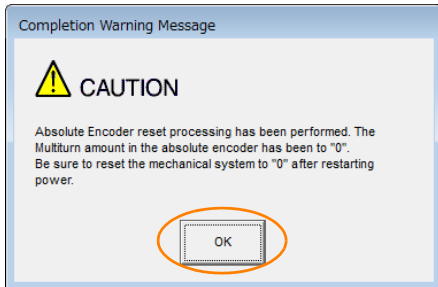

The Main Window will return.

8. To enable the change to the settings, turn the power supply to the SERVOPACK OFF and ON again.

This concludes the procedure to reset the absolute encoder.

5.16 Setting the Origin of the Absolute Linear Encoder

You can set any position as the origin in the following Linear Encoders.

- Dr. JOHANNES HEIDENHAIN GmbH
LIC4190, LIC3190, or LIC2190 Series
- RSF Elektronik GmbH
MC15Y Series
- Mitutoyo Corporation
ABS ST780A Series or ST1300 Series
Models: ABS ST78□A/ST78□AL/ST13□□
- Renishaw PLC
EVOLUTE Series
Models: EL36Y□□□□□□□□□□
- Renishaw PLC
RESOLUTE Series
Models: RL36Y□□□□□□□□□□
- Canon Precision Inc.
Model: PH03-36E00



Important

1. After you set the origin, the /S-RDY (Servo Ready) signal will become inactive because the system position data was changed. Always turn the SERVOPACK power supply OFF and ON again.
2. After you set the origin, the Servomotor phase data in the SERVOPACK will be discarded. If you are using a Linear Servomotor without a Polarity Sensor, execute polarity detection again to save the Servomotor phase data in the SERVOPACK.

5.16.1 Preparations

Always check the following before you set the origin of an absolute encoder.

- The parameters must not be write prohibited.
- The servo must be OFF.

5.16.2 Applicable Tools

The following table lists the tools that you can use to set the origin of the absolute linear encoder.

Tool	Fn No./Function Name	Reference
Digital Operator	Fn020	Σ -7-Series Digital Operator Operating Manual (Manual No.: SIEP S800001 33)
SigmaWin+	Encoder Setting – Zero Point Position Setting	Operating Procedure on page 5-52

5.16.3 Operating Procedure

Use the following procedure to set the origin of an absolute linear encoder.

1. Click the  Servo Drive Button in the workspace of the Main Window of the SigmaWin+.
2. Select **Zero Point Position Setting** in the Menu Dialog Box.
The Set Origin Dialog Box will be displayed.
3. Click the **Continue** Button.

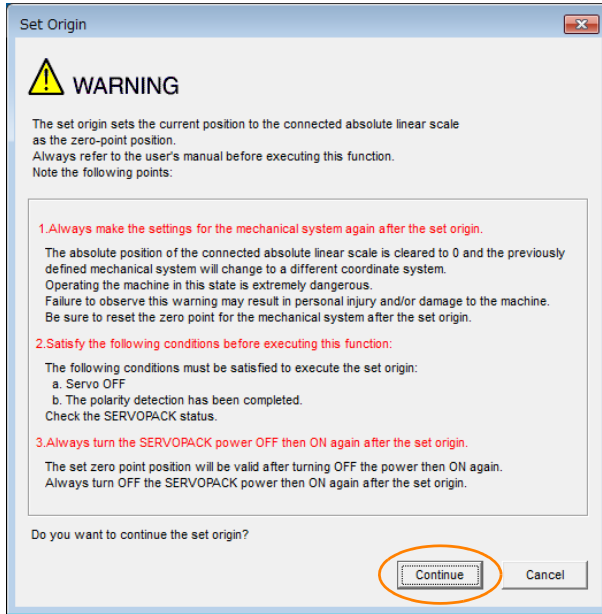

4. Click the **Execute** Button.

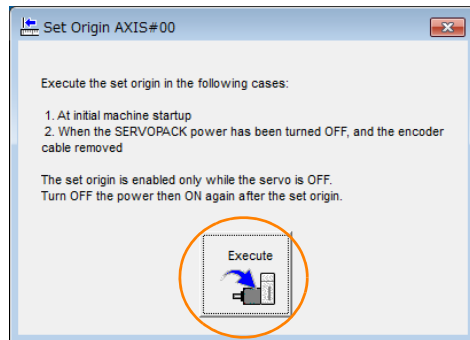

5. Click the **Continue** Button.

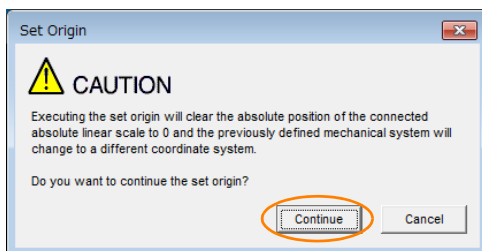

Click the **Cancel** Button to cancel setting the origin of the absolute linear encoder. The previous dialog box will return.

6. Click the OK Button.

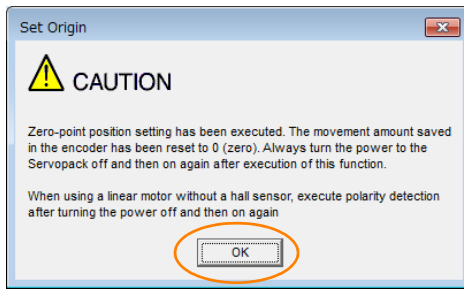

7. Turn the power supply to the SERVOPACK OFF and ON again.

8. If you use a Linear Servomotor that does not have a polarity sensor, perform polarity detection.

Refer to the following section for details on the polarity detection.

 5.9 Polarity Detection on page 5-24

This concludes the procedure to set the origin of the absolute linear encoder.

5.17 Setting the Regenerative Resistor Capacity

The regenerative resistor consumes regenerative energy that is generated by the Servomotor, e.g., when the Servomotor decelerates.

If an External Regenerative Resistor is connected, you must set Pn600 (Regenerative Resistor Capacity) and Pn603 (Regenerative Resistor Resistance).

Refer to the following manual to select the capacity of a Regenerative Resistor.

📖 Σ -7-Series Peripheral Device Selection Manual (Manual No.: S1EP S800001 32)

WARNING

- If you connect an External Regenerative Resistor, set Pn600 and Pn603 to suitable values. If a suitable value is not set, A.320 alarms (Regenerative Overload) will not be detected correctly, and the External Regenerative Resistor may be damaged or personal injury or fire may result.
- When you select an External Regenerative Resistor, make sure that it has a suitable capacity. There is a risk of personal injury or fire.

	Regenerative Resistor Capacity				
	Setting Range	Setting Unit	Default Setting	When Enabled	Classification
Pn600	0 to SERVOPACK's maximum applicable motor capacity	10 W	0	Immediately	Setup
	Regenerative Resistor Resistance				
	Setting Range	Setting Unit	Default Setting	When Enabled	Classification
Pn603	0 to 65,535	10 m Ω	0	Immediately	Setup

Set the regenerative resistor capacity to a value that is consistent with the allowable capacity of the External Regenerative Resistor. The setting depends on the cooling conditions of the External Regenerative Resistor.

- For self-cooling (natural convection cooling): Set the parameter to a maximum 20% of the capacity (W) of the actually installed regenerative resistor.
- For forced-air cooling: Set the parameter to a maximum 50% of the capacity (W) of the actually installed regenerative resistor.

Example For a self-cooling 100-W External Regenerative Resistor, set Pn600 to 2 (x10 W) (100 W x 20% = 20 W).

Note: 1. An A.320 alarm will be displayed if the setting is not suitable.
 2. The default setting of 0 specifies that the SERVOPACK's built-in regenerative resistor or Yaskawa's Regenerative Resistor Unit is being used.

Important

1. When an External Regenerative Resistor is used at the normal rated load ratio, the resistor temperature increases to between 200°C and 300°C. Always apply derating. Consult the manufacturer for the resistor's load characteristics.
2. For safety, use an External Regenerative Resistor with a thermoswitch.

Application Functions

6

This chapter describes the application functions that you can set before you start servo system operation. It also describes the setting methods.

6.1	I/O Signals	6-3
6.1.1	Input Signals	6-3
6.1.2	Output Signals	6-7
6.2	Operation for Momentary Power Interruptions ..	6-11
6.3	SEMI F47 Function	6-12
6.4	Setting the Motor Maximum Speed	6-14
6.5	Encoder Divided Pulse Output	6-15
6.5.1	Encoder Divided Pulse Output Signals	6-15
6.5.2	Setting for the Encoder Divided Pulse Output ..	6-20
6.6	Internal Torque Limits	6-22
6.7	Absolute Encoders	6-23
6.7.1	Connecting an Absolute Encoder	6-24
6.7.2	Multiturn Limit Setting	6-25
6.7.3	Multiturn Limit Disagreement Alarm (A.CC0) ..	6-26
6.8	Absolute Linear Encoders	6-29
6.8.1	Connecting an Absolute Linear Encoder	6-29

6.9	Software Reset	6-30
6.9.1	Preparations	6-30
6.9.2	Applicable Tools	6-30
6.9.3	Operating Procedure	6-30
6.10	Initializing the Vibration Detection Level	6-32
6.10.1	Preparations	6-32
6.10.2	Applicable Tools	6-33
6.10.3	Operating Procedure	6-33
6.10.4	Related Parameters	6-35
6.11	Adjusting the Motor Current Detection Signal Offset	6-36
6.11.1	Automatic Adjustment	6-36
6.11.2	Manual Adjustment	6-38
6.12	Overheat Protection	6-40
6.12.1	Connecting the Overheat Protection Input (TH) Signal	6-40
6.12.2	Overheat Protection Selection	6-42

6.1 I/O Signals

6.1.1 Input Signals

/S-ON (Servo ON) Signal

This signal enables operation of the Servomotor.

Type	Signal	Connector Pin No.	Signal Status	Function
Input	/S-ON	CN1-13	ON (closed)	Power is supplied to the Servomotor to enable operation.
			OFF (open)	Power supply to the Servomotor is stopped and operation is disabled.



Input the /S-ON signal while the Servomotor is stopped. You cannot turn ON the servo while the Servomotor is operating.

You can change the setting for the /S-ON signal with PnB0E.

Parameter		Meaning	When Enabled	Classification
PnB0E	0 (default setting)	When input signal is ON (closed), servomotor power is ON. Servomotor can be operated.	After restart	Setup
	1	When input signal is OFF (open), servomotor power is ON. Servomotor can be operated.		
	2	Always servo ON		
	3	Always servo OFF		



If a resettable alarm occurs and operation is disabled (power is not supplied to the motor), operation will be automatically enabled (power will be supplied to the motor) when the alarm is reset. If you set PnB0E to 2 (Servo always ON), the Servomotor or machine may perform unexpected operation when an alarm is reset.

P-OT (Forward Drive Prohibit) Signal and N-OT (Reverse Drive Prohibit) Signal

Refer to the following section for details.

5.10.2 *Overtravel Settings* on page 5-28

/ALM-RST (Alarm Reset) Signal

Refer to the following section for details.

15.2.4 *Resetting INDEXER Alarms* on page 15-49

/DEC (Homing Deceleration Switch Input) Signal

Connects the deceleration limit switch for homing.

Type	Signal	Pin No.	Signal Status	Meaning
Input	/DEC	CN1-10	ON (closed)	The homing speed is changed to the approach speed or creep speed. The operation depends on the homing method.
			OFF (open)	The speed does not change.

You can change the setting for the /DEC signal with PnB11.

Parameter	Meaning	When Enabled	Classification
PnB11	0 (default setting)	After restart	Setup
	1		
	2		
	3		

/RGRT (Registration Input) Signal

This is the latch signal that is used for registration (external positioning).

Type	Signal	Connector Pin No.	Signal Status	Meaning
Input	/RGRT	CN1-12	ON (closed)	The current position has reached the latch position.
			OFF (open)	The current position has not reached the latch position, or has passed the latch position.

You can change the setting for the /RGRT signal with PnB12.

Parameter	Meaning	When Enabled	Classification
PnB12	0 (default setting)	After restart	Setup
	1		
	2, 3		

/MODE 0/1 (Mode Switch Input) Signal

You can use this signal to change between Mode 0 (program table operation) and Mode 1 (jog speed table operation or homing).

Type	Signal	Pin No.	Signal Status	Meaning
Input	/MODE 0/1	CN11-3	ON (closed)	Mode 0 (Program Table Operation)
			OFF (open)	Mode 1 (jog speed table operation or homing)

You can change the setting for the /MODE 0/1 signal with PnB03.

Parameter	Meaning	When Enabled	Classification
PnB03	0 (default setting)	After restart	Setup
	1		
	2		
	3		

/START-STOP (Program Table Operation Start-Stop Input Signal)

This signal is used to start and stop operation for the program step that is specified by the /SEL0 to /SEL7 (Program Step Selection Inputs) signals.

Type	Signal	Pin No.	Signal Status	Meaning
Input	/START-STOP	CN11-5	ON (closed)	Turn ON this signal to start operation for the program step that is specified by the /SEL0 to /SEL7 (Program Step Selection Inputs) signals.
			OFF (open)	Turn OFF this signal to stop program table operation and decelerate the motor to a stop.

You can change the setting for the /START-STOP signal with PnB04. If you change the setting for the /START-STOP signal, set the /MODE 0/1 signal to ON (closed) (Mode 0).

Parameter		Meaning	When Enabled	Classification
PnB04	0 (default setting)	Starts program table operation when the /START-STOP signal turns ON (closes). Stops program table operation when the /START-STOP signal turns OFF (opens).	After restart	Setup
	1	Starts program table operation when the /START-STOP signal turns OFF (opens). Stops program table operation when the /START-STOP signal turns ON (closes).		
	2, 3	The /START-STOP signal is not used.		

/HOME (Homing Input) Signal

This signal functions as the homing command.

Type	Signal	Pin No.	Signal Status	Meaning
Input	/HOME	CN11-5	ON (closed)	Homing is started.
			OFF (open)	Stops homing.

You can change the setting for the /HOME signal with PnB04. If you change the setting for the /HOME signal, set the /MODE 0/1 signal to OFF (open) (Mode 1).

Parameter		Meaning	When Enabled	Classification
PnB04	0 (default setting)	Starts homing when the /HOME signal turns ON (closes).	After restart	Setup
	1	Starts homing when the /HOME signal turns OFF (opens).		
	2, 3	The /HOME signal is not used.		

/PGMRES (Program Table Operation Reset Input) Signal

If this signal turns ON while a program table operation is stopped, the program table operation will be reset and canceled.*

Type	Signal	Pin No.	Signal Status	Meaning
Input	/PGMRES	CN11-7	ON (closed)	Program table operation is reset.
			OFF (open)	Program table operation is not reset.

* "Canceled" is the state in which the mode is mode 0, execution is not in a stopped state, and no program step has been executed.

You can change the setting for the /PGMRES signal with PnB05. If you change the setting for the /PGMRES signal, set the /MODE 0/1 signal to ON (closed) (Mode 0).

Parameter		Meaning	When Enabled	Classification
PnB05	0 (default setting)	Resets and cancels program table operation by switching the /PGMRES signal from OFF (open) to ON (closed).	After restart	Setup
	1	Resets and cancels program table operation by switching the /PGMRES signal from ON (closed) to OFF (open).		
	2, 3	Program table operation is not reset.		

/JOGP (Forward Jog Input) Signal

This signal functions as the forward jog operation command.

Type	Signal	Pin No.	Signal Status	Meaning
Input	/JOGP	CN11-7	ON (closed)	Forward jog operation is performed. Jog operation is performed as long as the signal is ON.
			OFF (open)	Stops the jog operation.

You can change the setting for the /JOGP signal with PnB05. If you change the setting for the /JOGP signal, set the /MODE 0/1 signal to OFF (open) (Mode 1).

Parameter	Meaning	When Enabled	Classification
PnB05	0 (default setting)	After restart	Setup
	1		
	2, 3		

/JOGN (Reverse Jog Input) Signal

This signal functions as the reverse jog operation command.

Type	Signal	Pin No.	Signal Status	Meaning
Input	/JOGN	CN11-9	ON (closed)	Reverse jog operation is performed. Jog operation is performed as long as the signal is ON.
			OFF (open)	Stops the jog operation.

You can change the setting for the /JOGN signal with PnB06. If you change the setting for the /JOGN signal, set the /MODE 0/1 signal to OFF (open) (Mode 1).

Parameter	Meaning	When Enabled	Classification
PnB06	0 (default setting)	After restart	Setup
	1		
	2, 3		

/JOG0 to /JOG3 (Jog Speed Table Selection Inputs) Signals

These signals specify the speed in the jog speed table.

Type	Signal	Pin No.	Signal Status	Meaning
Input	/JOG0 to /JOG3	CN11-11, -13, -15, and -17	ON (closed)	These signals specify a jog speed that is registered in the jog speed table. Refer to the following section for details.  13.4.3 Jog Speed Table and Speed Selection Signals on page 13-45
			OFF (open)	

You can change the settings for the /JOG0 to /JOG3 signals with PnB07 to PnB0A. If you change the settings for the /JOG0 to /JOG3 signals, set the /MODE 0/1 signal to OFF (open) (Mode 1).

Parameter	Meaning	When Enabled	Classification
PnB07 PnB08 PnB09 PnB0A	0 (default setting)	After restart	Setup
	1		
	2		
	3		

/SEL0 to /SEL7 (Program Step Selection Inputs) Signals

These signals specify the program step.

Type	Signal	Pin No.	Signal Status	Meaning
Input	/SEL0 to /SEL7	CN11-9, -11, -13 to -18	ON (closed)	These signals specify the program step number at which to start program table operation. Refer to the following section for details.  <i>Input Signals Related to Program Table Operation on page 13-11</i>
			OFF (open)	

You can change the settings for the /SEL0 to /SEL7 signals with PnB06 to PnB0D. If you change the settings for the /SEL0 to /SEL4 signals, set the /MODE 0/1 signal to ON (closed) (Mode 0). If you change the settings for the /SEL5 to /SEL7 signals, the setting of the /MODE 0/1 signal is irrelevant.

Parameter	Meaning	When Enabled	Classification
PnB06 PnB07	0 (default setting)	After restart	Setup
PnB08	1		
PnB09 PnB0A	2		
PnB0B PnB0C PnB0D	3		

6.1.2 Output Signals

ALM (Servo Alarm) Signal

This signal is output when the SERVOPACK detects an error.



Configure an external circuit so that this alarm output turns OFF the main circuit power supply to the SERVOPACK whenever an error occurs.

Important

Type	Signal	Connector Pin No.	Signal Status	Meaning
Output	ALM	CN1-3 and CN1-4	ON (closed)	Normal SERVOPACK status
			OFF (open)	SERVOPACK alarm

Alarm Code (/ALO1 to /ALO3) Signals

The ALO1 to ALO3 (Alarm Code) signals report alarms and warnings that occur in the SERVOPACK. Use the alarm code output signals as required to display the contents of the alarm at the host controller (e.g., HMI).

Refer to the following sections for details on the alarm codes.

 15.2.1 List of Alarms on page 15-5

Type	Signal Name	Pin No.	Description
Output	/ALO1	CN1-1, -2	Alarm code output
	/ALO2	CN1-23, -24	Alarm code output
	/ALO3	CN1-25, -26	Alarm code output

Select whether /ALO1 to /ALO3 are used or /WARN, /BK and /S-RDY are used with the parameter below.

Parameter		Meaning	When Enabled
PnB51	0 (default setting)	Does not output /ALO1 to /ALO3. (/WARN, /BK, and /S-RDY are output.)	After restart
	1	Outputs /ALO1 to /ALO3. (/WARN, /BK, and /S-RDY are not output.)	

/WARN (Warning) Signal

This signal is for an error or warning issued before the occurrence of an alarm. A signal is output for only 2 seconds for errors. A signal is continuously output for warnings until the cause of the warning is removed. There is no need to stop operation.

The /WARN signal is allocated to CN1-1 and CN1-2 by default.

Type	Signal	Connector Pin No.	Signal Status	Meaning
Output	/WARN	CN1-1 and CN1-2 (default setting)	ON (closed)	Warning
			OFF (open)	Normal status

Note: You can use PnB51 to allocate the /ALO1 to /ALO3 signals instead of the /WARN, /BK, and /S-RDY signals. Refer to the following section for details.

Alarm Code (/ALO1 to /ALO3) Signals on page 6-7

You can change the setting for the /WARN signal with PnB1C.

Parameter		Meaning	When Enabled
PnB1C	0 (default setting)	When an error/warning occurs (error/warning status), the /WARN signal turns ON (closes).	After restart
	1	When an error/warning occurs (error/warning status), the /WARN signal turns OFF (opens).	

◆ Setting the Warning Code Output

You can use the /ALO1 to /ALO3 (Alarm Code Output) signals to output warning codes. Use Pn001 = n.X□□□ (Warning Code Output Selection) to set the output.

Refer to the following sections for details on the warnings.

15.3.1 List of Warnings on page 15-57

Parameter	Description	When Enabled	Classification
Pn001	n.0□□□	After restart	Setup
	n.1□□□		

/BK (Brake) Signal

Refer to the following section for details.

5.11.2 Allocating the /BK (Brake) Signal on page 5-32

/S-RDY (Servo Ready) Signal

The /S-RDY (Servo Ready) signal turns ON when the SERVOPACK is ready to accept the /S-ON (Servo ON) input signal. The /S-RDY signal is turned ON under the following conditions.

- Main circuit power supply is ON.
- There is no hard wire base block state.
- There are no alarms.
- If a Servomotor without a polarity sensor is used, polarity detection has been completed.

The /S-RDY signal is allocated to CN1-25 and CN1-26 by default.

Type	Signal	Connector Pin No.	Signal Status	Meaning
Output	/S-RDY	CN1-25 and CN1-26 (default setting)	ON (closed)	Ready to receive the /S-ON (Servo ON) signal.
			OFF (open)	Not ready to receive the /S-ON (Servo ON) signal.

Note: 1. You can use PnB51 to allocate the /ALO1 to /ALO3 signals instead of the /WARN, /BK, and /S-RDY signals. Refer to the following section for details.

 [Alarm Code \(/ALO1 to /ALO3\) Signals on page 6-7](#)

2. Refer to the following section for information on the hard wire base block and the /S-RDY signal.

 [11.2.7 /S-RDY \(Servo Ready Output\) Signal on page 11-6](#)

3. Refer to the following section for information on the polarity detection.

 [5.9 Polarity Detection on page 5-24](#)

You can change the setting for the /S-RDY signal with PnB1E.

Parameter	Meaning	When Enabled
PnB1E	0 (default setting)	After restart
	1	

/INPOSITION (Positioning Completion Output Signal)

This signal indicates that servomotor positioning has been completed.

The signal is output when the motor stops, even if the current position has not reached the target position.

If the difference between the reference from the INDEXER Module and the movement of the servomotor (the number of position error pulses) drops below the value set for this parameter, the positioning completed signal will be output.

Use this signal to confirm whether positioning has been completed at the host controller.

Type	Signal Name	Pin No.	Output Status	Meaning
Output	/INPOSITION	CN11-19, -20	ON (closed)	Positioning has been completed.
			OFF (open)	Positioning is not completed.

Parameter	Meaning	When Enabled
PnB13	0 (default setting)	After restart
	1	

PnB2D	/INPOSITION width			
	Setting Range	Setting Unit	Default Setting	When Enabled
	0 to 99999	1 reference unit	1	Immediately

- The inposition width setting has no effect on final positioning accuracy.

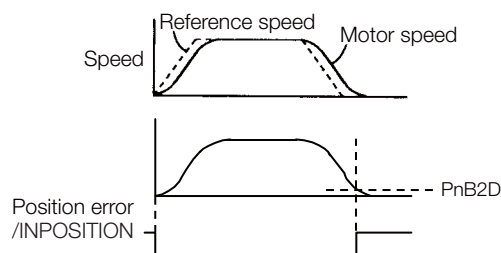

◆ Notes when the Positioning Completed State is Established while Canceling a Motion Command

When the SERVOPACK enters any of the following states during execution of a motion command, it may cancel the execution of the motion command and establish the positioning completed state.

- The servo OFF state has been established due to an alarm.
- The servo OFF state has been established because the main power supply was turned OFF.
- The motor has stopped due to overtravel or a software limit.

In this case, the motor has not reached the target position specified by the host controller. Check the current position to confirm that the axis is stopped at a safe position.



Important

If the state of an OT signal varies over a short time (in a pulsing manner for example), the host controller may not be able to monitor the variation of the OT signal properly. Take due care about the selection of limit switches and their mounting and wiring to avoid chattering of OT signals and malfunctioning.

/POUT0 to /POUT7 (Program Step Number) Signals

These signals output the specified status. The output status is specified with POUT in the program steps or with the POUT serial command.

Type	Signal	Pin No.	Signal Status	Meaning
Output	/POUT0 to /POUT7	CN11-21 to -36	ON (closed)	The /POUT0 to /POUT7 signals output the status that is specified with POUT in the program steps or with the POUT serial command.
			OFF (open)	

You can change the settings for the /POUT0 to /POUT7 signals with PnB14 to PnB1B.

Parameter	Meaning	When Enabled	Classification
PnB14 PnB15 PnB16 PnB17	0 (default setting) The /POUT□ signal turns ON (opens) when programmable output □ is active.	After restart	Setup
PnB18 PnB19 PnB1A PnB1B	1 The /POUT□ signal turns OFF (closes) when programmable output □ is active.		

/Z0 to /Z4 (ZONE Output) Signals

These signals indicate when the current position is within a zone specified in the ZONE table.

Note: You can use the initial status of the programmable output signals (/POUT0 to /POUT7) as the ZONE signals. Refer to the following section for details.

13.5.2 Parameters Related to ZONE Signals on page 13-54

Type	Signal	Pin No.	Signal Status	Meaning
Output	/Z0 to /Z4	Must be allocated.	ON (closed)	The /Z0 to /Z4 signals give a 5-bit binary number. Z0 to Z3 specify a ZONE.
			OFF (open)	

/PAO, /PBO, and /PCO (Encoder Output) Signals

Refer to the following section for information on the /PAO, /PBO, and /PCO (encoder output) signals.

6.5 Encoder Divided Pulse Output on page 6-15

6.2 Operation for Momentary Power Interruptions

Even if the main power supply to the SERVOPACK is interrupted momentarily, power supply to the motor (servo ON status) will be maintained for the time set in Pn509 (Momentary Power Interruption Hold Time).

Pn509	Momentary Power Interruption Hold Time				
	Setting Range	Setting Unit	Default Setting	When Enabled	Classification
	20 to 50,000	1 ms	20	Immediately	Setup

If the momentary power interruption time is equal to or less than the setting of Pn509, power supply to the motor will be continued. If it is longer than the setting, power supply to the motor will be stopped. Power will be supplied to the motor again when the main circuit power supply recovers.

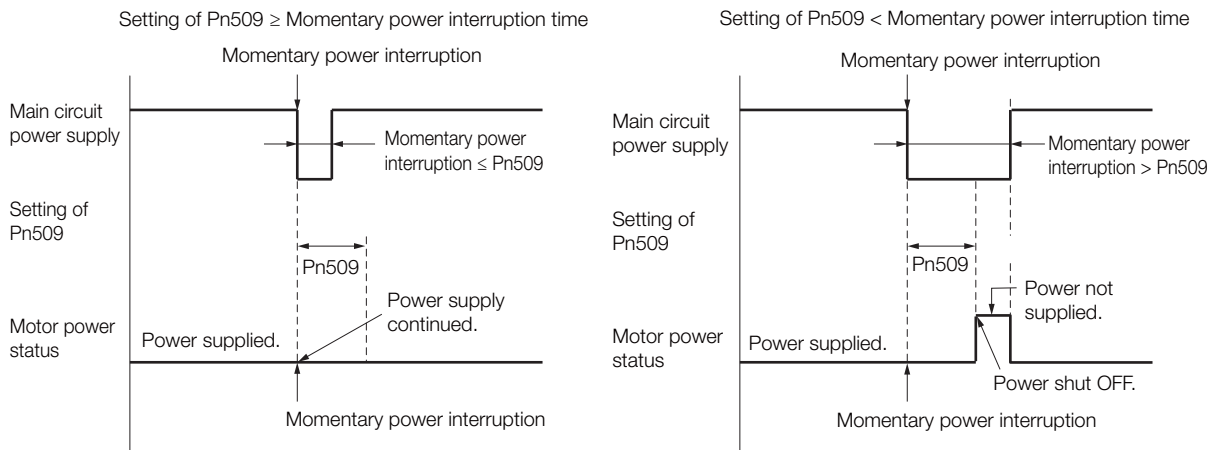

Information

1. If the momentary power interruption time exceeds the setting of Pn509, the /S-RDY (Servo Ready) signal will turn OFF.
2. If uninterruptible power supplies are used for the control power supply and main circuit power supply, the SERVOPACK can withstand a power interruption that lasts longer than 50,000 ms.
3. The holding time of the SERVOPACK control power supply is approximately 100 ms. If control operations become impossible during a momentary power interruption of the control power supply, the setting of Pn509 will be ignored and the same operation will be performed as for when the power supply is turned OFF normally.



Important The holding time of the main circuit power supply depends on the output from the SERVOPACK. If the load on the Servomotor is large and an A.410 alarm (Undervoltage) occurs, the setting of Pn509 will be ignored.

Application Functions

6.3 SEMI F47 Function

The SEMI F47 function detects an A.971 warning (Undervoltage) and limits the output current if the DC main circuit power supply voltage to the SERVOPACK drops to a specified value or lower because the power was momentarily interrupted or the main circuit power supply voltage was temporarily reduced.

This function complies with the SEMI F47 standards for semiconductor manufacturing equipment.

You can combine this function with the momentary power interruption hold time (Pn509) to allow the Servomotor to continue operating without stopping for an alarm or without recovery work even if the power supply voltage drops.

Execution Sequence

This function can be executed either with the host controller or with the SERVOPACK. Use Pn008 = n.□□X□ (Function Selection for Undervoltage) to specify whether the function is executed by the host controller or by the SERVOPACK.

The default setting (Pn008 = n.□□0□) disables detection of an A.971 warning (Undervoltage).

Parameter	Description	When Enabled	Classification
Pn008	n.□□0□ (default setting)		
	n.□□1□	After restart	Setup
	n.□□2□		

◆ Execution with the Host Controller (Pn008 = n.□□1□)

The host controller limits the torque in response to an A.971 warning (Undervoltage).

The host controller removes the torque limit after the Undervoltage warning is cleared.

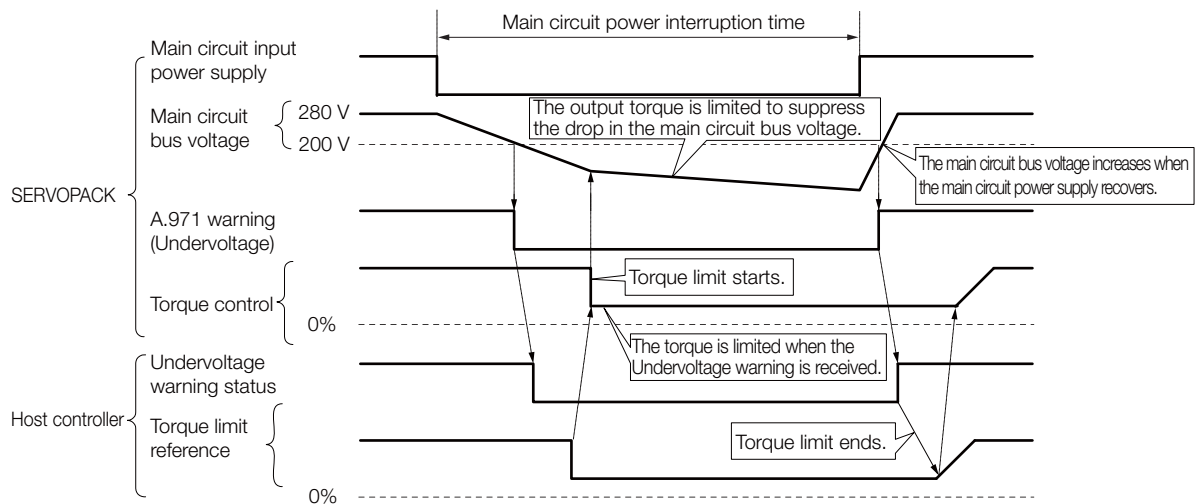

◆ Execution with the SERVOPACK (Pn008 = n.□□2□)

The torque is limited in the SERVOPACK in response to an Undervoltage warning. The SERVOPACK controls the torque limit for the set time after the Undervoltage warning is cleared.

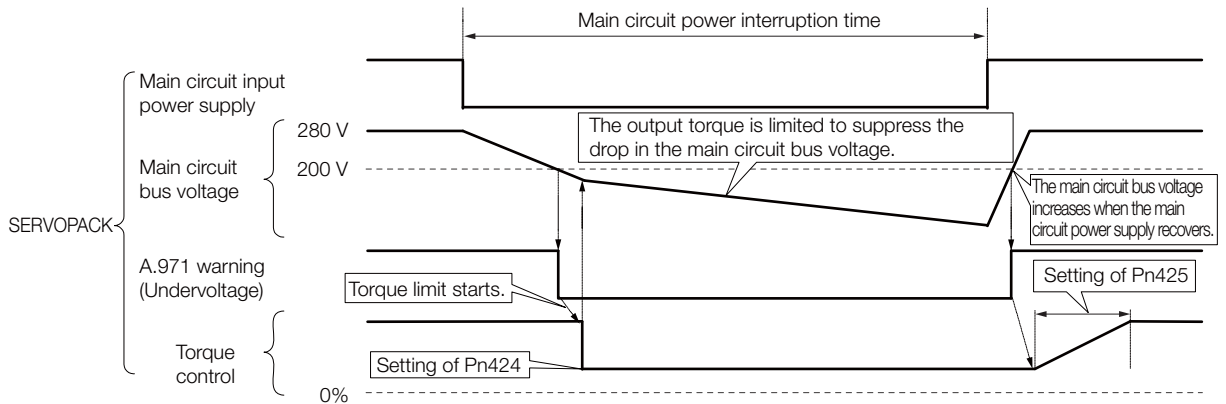

Related Parameters

The following parameters are related to the SEMI F47 function.

Pn424	Torque Limit at Main Circuit Voltage Drop				
	Setting Range	Setting Unit	Default Setting	When Enabled	Classification
	0 to 100	1%*	50	Immediately	Setup
Pn425	Release Time for Torque Limit at Main Circuit Voltage Drop				
	Setting Range	Setting Unit	Default Setting	When Enabled	Classification
	0 to 1,000	1 ms	100	Immediately	Setup
Pn509	Momentary Power Interruption Hold Time				
	Setting Range	Setting Unit	Default Setting	When Enabled	Classification
	20 to 50,000	1 ms	20	Immediately	Setup

* Set a percentage of the motor rated torque.

Note: If you will use the SEMI F47 function, set the time to 1,000 ms.



Important

- This function handles momentary power interruptions for the voltage and time ranges stipulated in SEMI F47. An uninterruptible power supply (UPS) is required as a backup for momentary power interruptions that exceed these voltage and time ranges.
- Set the host controller or SERVOPACK torque limit so that a torque reference that exceeds the specified acceleration torque will not be output when the power supply for the main circuit is restored.
- For a vertical axis, do not limit the torque to a value that is lower than the holding torque.
- This function limits torque within the range of the SERVOPACK's capability for power interruptions. It is not intended for use under all load and operating conditions. Set the parameters while monitoring operation on the actual machine.
- You can set the momentary power interruption hold time to increase the amount of time from when the power supply is turned OFF until power supply to the motor is stopped. To stop the power supply to the motor immediately, turn OFF the /S-ON (Servo ON) signal.

6.4 Setting the Motor Maximum Speed

You can set the maximum speed of the Servomotor with the following parameter.

- Rotary Servomotors

Pn316	Maximum Motor Speed				
	Setting Range	Setting Unit	Default Setting	When Enabled	Classification
	0 to 65,535	1 min ⁻¹	10,000	After restart	Setup

- Linear Servomotors



Pn385	Maximum Motor Speed				
	Setting Range	Setting Unit	Default Setting	When Enabled	Classification
	1 to 100	100 mm/s	50	After restart	Setup

You can achieve the following by lowering the maximum speed of the Servomotor.

- If the Servomotor speed exceeds the setting, an A.510 alarm (Overspeed) will occur.
- With a Linear Servomotor, you can increase the upper limit for the setting of Pn281 (Encoder Output Resolution). Refer to the following section for details.

 [6.5 Encoder Divided Pulse Output](#) on page 6-15

Changing the setting of the parameter is effective in the following cases.

- To protect the machine by stopping machine operation with an alarm when the set speed is reached or exceeded
- To limit the speed so that the load is driven beyond the allowable moment of inertia
Refer to relevant manual from the following list for the relationship between the speed and the allowable moment of inertia.
 -  [Σ-7-Series Rotary Servomotor Product Manual \(Manual No.: SIEP S800001 36\)](#)
 -  [Σ-7-Series Direct Drive Servomotor Product Manual \(Manual No.: SIEP S800001 38\)](#)
 -  [Σ-7-Series Linear Servomotor Product Manual \(Manual No.: SIEP S800001 37\)](#)
- To increase the encoder output resolution and increase the position resolution managed by the host controller (for a Linear Servomotor)

6.5

Encoder Divided Pulse Output

The encoder divided pulse output is a signal that is output from the encoder and processed inside the SERVOPACK. It is then output externally in the form of two phase pulse signals (phases A and B) with a 90° phase differential. At the host controller, it can be used as the position feedback.

The encoder signals can be used to monitor the servomotor's speed and position. However, the INDEXER Module manages the servomotor's speed and position so it is not necessary to use the encoder signals to monitor the speed and position from the host controller.

The following table describes the signals and output phase forms.

6.5.1

Encoder Divided Pulse Output Signals

Type	Signal	Connector Pin No.	Name	Remarks	
Output	PAO	CN1-17	Encoder Divided Pulse Output, Phase A	<ul style="list-style-type: none"> Rotary Servomotors These encoder divided pulse output pins output the number of pulses per Servomotor resolution that is set in Pn212 (Number of Encoder Output Pulses). The phase difference between phase A and phase B is an electric angle of 90°. Linear Servomotors These encoder divided pulse output pins output pulses at the resolution that is set in Pn281 (Encoder Output Resolution). The phase difference between phase A and phase B is an electric angle of 90°. 	
	/PAO	CN1-18			
	PBO	CN1-19	Encoder Divided Pulse Output, Phase B		
	/PBO	CN1-20			
	PCO	CN1-21	Encoder Divided Pulse Output, Phase C*		These pins output one pulse every Servomotor rotation.
	/PCO	CN1-22			

* Refer to the following section for more information on encoder phase C.

 **◆ Relation between Renishaw PLC Incremental Linear Encoders and Encoder Output Pulse Signal from the SERVOPACK When Using an RGS20 Scale and RGH22B Sensor Head, or a TONIC Series Encoder on page 6-16**

- Rotary Servomotor

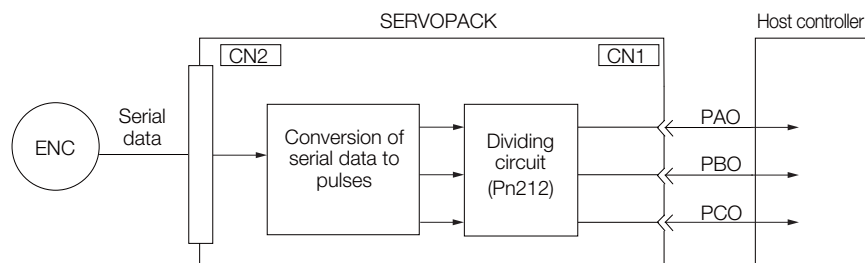

- Linear Servomotors

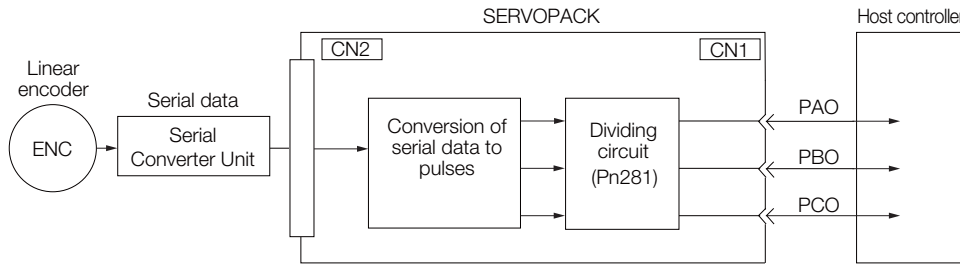

Output Phase Forms

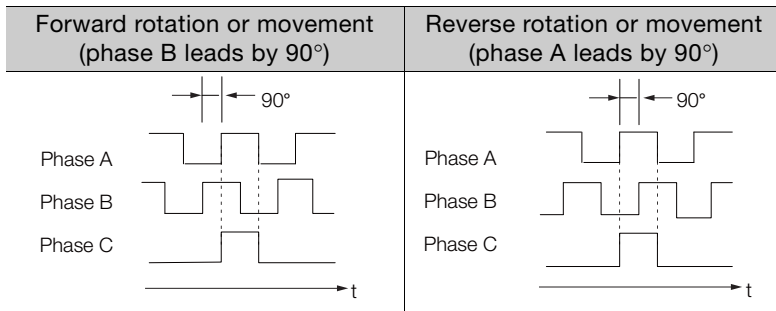

Note: The pulse width of encoder phase C depends on the setting of Pn212 (Number of Encoder Output Pulses) or Pn281 (Encoder Output Resolution). It is the same as the width of phase A. Even for Pn000 = n.□□□1 (reverse operation), the output phase form is the same as shown above.

Important

If you use the SERVOPACK's phase-C pulse output for homing, rotate the Servomotor two or more rotations before you start homing. If the Servomotor cannot be rotated two or more times, perform homing at a motor speed of 600 min⁻¹ or lower. If the motor speed is higher than 600 min⁻¹, the phase-C pulse may not be output correctly.

Linear Encoder Application Precautions

The following precautions apply to the encoder output pulses when an external linear encoder is used.

◆ Relation between Renishaw PLC Incremental Linear Encoders and Encoder Output Pulse Signal from the SERVOPACK When Using an RGS20 Scale and RGH22B Sensor Head, or a TONIC Series Encoder

The output position of the origin signal (Ref) will depend on the direction of movement for some models of incremental linear encoders from Renishaw PLC.

In that case, the phase-C pulse of the SERVOPACK is output at two positions.

For detailed specifications on the origin signal, refer to the manual for the Renishaw PLC incremental linear encoder.

■ When Passing the First Origin Signal (Ref) in the Forward Direction and Returning after Turning ON the Power Supply

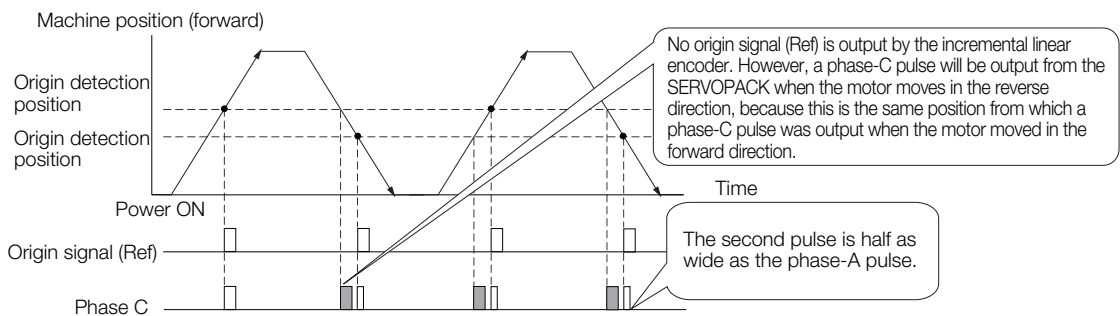

■ When Passing the First Origin Signal (Ref) in the Reverse Direction and Returning after Turning ON the Power Supply

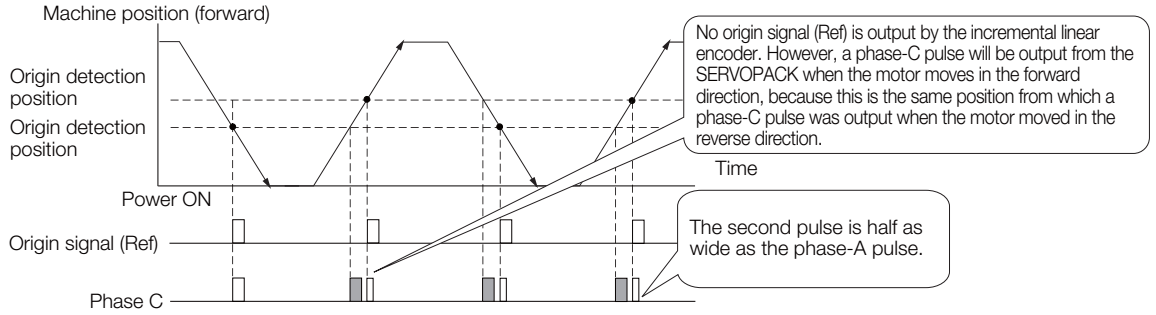

◆ Precautions When Using a Linear Incremental Encoder from Magnescape Co., Ltd.

■ Encoder Divided Phase-C Pulse Output Selection

You can also output the encoder's phase-C pulse for reverse movement. To do so, set Pn081 to n.□□□1.

Parameter	Meaning	When Enabled	Classification
Pn081	n.□□□0 (default setting)	After restart	Setup
	n.□□□1		



Important

Precautions on Setting the Phase-C Pulse Output Selection (Pn081 = n.□□□X)

- If you set Pn081 to n.□□□1 (Output phase-C pulses in both the forward and reverse directions), the width of the phase-C pulse output may be narrower than the width of the phase-A pulse.
- There is a difference of 1/8th of the scale pitch in the phase-C detection position for the encoder's phase-C pulse output position between when Pn081 = n.□□□X is set to 0 (Output phase-C pulses only in the forward direction) and when it is set to 1 (Output phase-C pulses in both the forward and reverse directions).

Movement in the forward direction →

The diagram shows two horizontal timelines. The top timeline is for Pn081 = n.□□□0. It shows a pulse labeled 'Origin' occurring at the start of a 'One linear encoder pitch' interval. The bottom timeline is for Pn081 = n.□□□1. It shows a pulse labeled 'Origin' occurring at the start of a '1/8 linear encoder pitch' interval.

Observe the following precaution if you set Pn081 to n.□□□0 (Output phase-C pulses only in the forward direction).

6.5.1 Encoder Divided Pulse Output Signals

When a linear incremental encoder from Magnescale Co., Ltd. is used, the count direction of the encoder determines how the phase-C pulse (CN1-21 and CN1-22) is output.

Note: The count direction (up or down) of the linear encoder determines whether a phase-C pulse is output. The output of the pulse does not depend on the setting of the movement direction (Pn000 = n.□□□1).

Encoder Model	Interpolator	Linear Encoder Pitch [μm]
SL710	PL101-RY MJ620-T13	800
SL720		800
SL730		800
	SR75	80
	SR85	80
SQ10	MQ10-FLA	400
	MQ10-GLA	

■ When First Passing the Origin Signal in the Forward Direction and Returning after Turning ON the Power Supply

The encoder's phase-C pulse (CN1-21 and CN1-22) is output when the origin detection position is passed for the first time in the forward direction after the power supply is turned ON.

After that, the phase-C pulse is output whenever the origin detection position is passed in the forward or reverse direction.

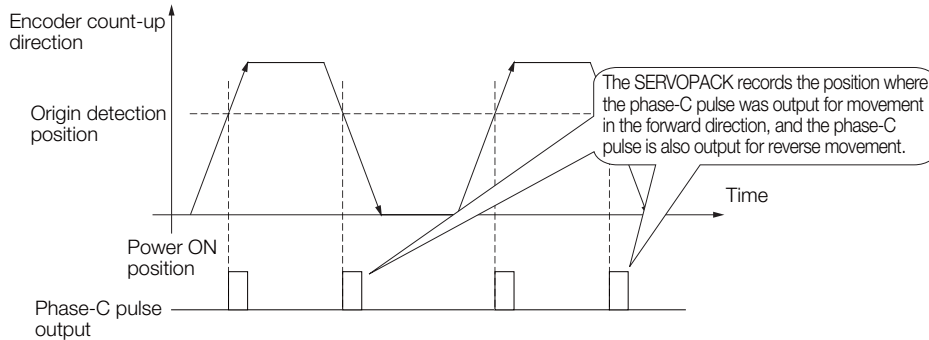

■ When First Passing the Origin Signal in the Reverse Direction and Returning after Turning ON the Power Supply

The encoder's phase-C pulse (CN1-19 and CN1-20) is not output when the origin detection position is passed for the first time in the reverse direction after the power supply is turned ON.

However, after the origin detection position is passed in the forward direction and the encoder's phase-C pulse is output, it will then also be output when the origin detection point is passed in the reverse direction.

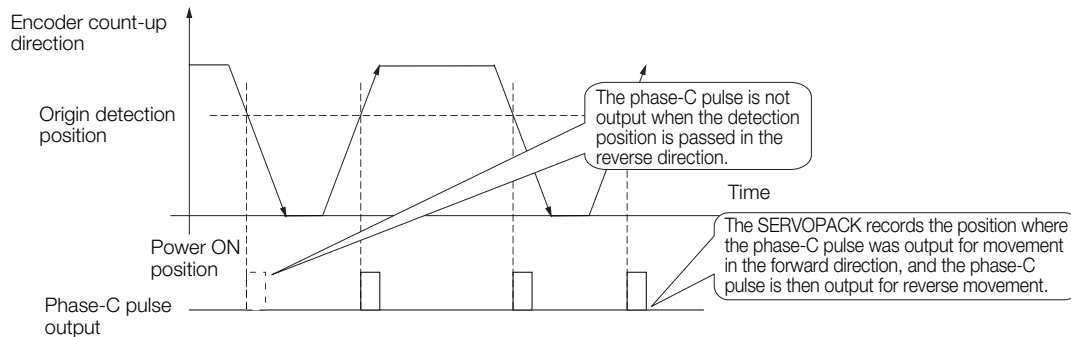

■ **When Using a Linear Encoder with Multiple Origins and First Passing the Origin Position in the Forward Direction and Returning after Turning ON the Power Supply**

The encoder's phase-C pulse is output when the origin detection position is passed for the first time in the forward direction after the power supply is turned ON. After that, the phase-C pulse is output whenever the origin detection position is passed in the forward or reverse direction.

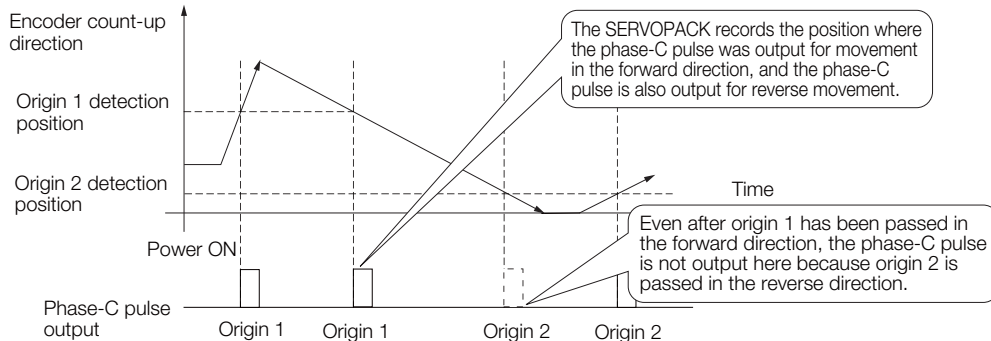

■ **When Using a Linear Encoder with Multiple Origins and First Passing the Origin Position in the Reverse Direction after Turning ON the Power Supply**

The encoder's phase-C pulse is not output when the origin detection position is passed for the first time in the reverse direction after the power supply is turned ON.

However, after the origin detection position is passed in the forward direction and the encoder's phase-C pulse is output, it will then also be output when the origin detection point is passed in the reverse direction.

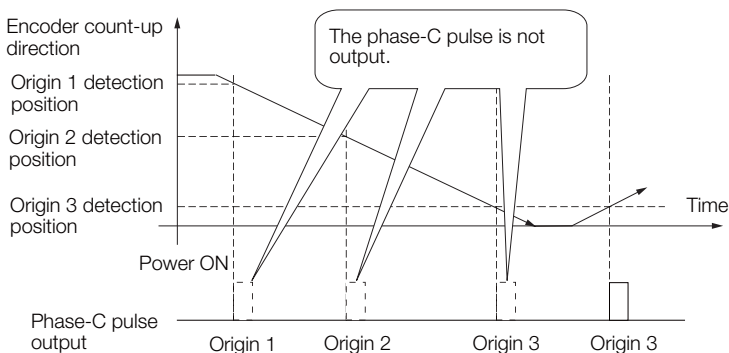

6.5.2 Setting for the Encoder Divided Pulse Output

This section describes the setting for the encoder divided pulse output for a Rotary Servomotor or Linear Servomotor.

Encoder Divided Pulse Output When Using a Rotary Servomotor

If you will use a Rotary Servomotor, set the number of encoder output pulses (Pn212).

Pn212	Number of Encoder Output Pulses				
	Setting Range	Setting Unit	Default Setting	When Enabled	Classification
	16 to 1,073,741,824	1 P/Rev	2,048	After restart	Setup

The number of pulses from the encoder per rotation are processed inside the SERVOPACK, divided by the setting of Pn212, and then output.

Set the number of encoder divided output pulses according to the system specifications of the machine or host controller.

The setting of the number of encoder output pulses is limited by the resolution of the encoder.

Setting of the Number of Encoder Output Pulses [P/Rev]	Setting Increment	Encoder Resolution			Upper Limit of Servomotor Speed for Set Number of Encoder Output Pulses [min ⁻¹]
		20 bits (1,048,576 pulses)	22 bits (4,194,304 pulses)	24 bits (16,777,216 pulses)	
16 to 16,384	1	○	○	○	6,000
16,386 to 32,768	2	○	○	○	3,000
32,772 to 65,536	4	○	○	○	1,500
65,544 to 131,072	8	○	○	○	750
131,088 to 262,144	16	○	○	○	375
262,176 to 524,288	32	–	○	○	187
524,352 to 1,048,576	64	–	○	○	93
1,048,704 to 2,097,152	128	–	–	○*	46
2,097,408 to 4,194,304	256	–	–	○*	23

* Available only for incremental encoder

Note: 1. The setting range of the number of encoder output pulses (Pn212) depends on the resolution of the Servomotor encoder. An A.041 alarm (Encoder Output Pulse Setting Error) will occur if the above setting conditions are not met.

Correct setting example: Pn212 can be set to 25,000 [P/Rev].

Incorrect setting example: Pn212 cannot be set to 25,001 (P/Rev) because the setting increment in the above table is not used.

2. The upper limit of the pulse frequency is approximately 1.6 Mpps. The Servomotor speed will be limited if the setting of the number of encoder output pulses is too high.

An A.511 alarm (Encoder Output Pulse Overspeed) will occur if the upper limit of the motor speed is exceeded.

Output example: An output example is given below for the PAO (Encoder Pulse Output Phase A) signal and the PBO (Encoder Pulse Output Phase B) signal when Pn212 is set to 16 (16 pulses output per revolution).

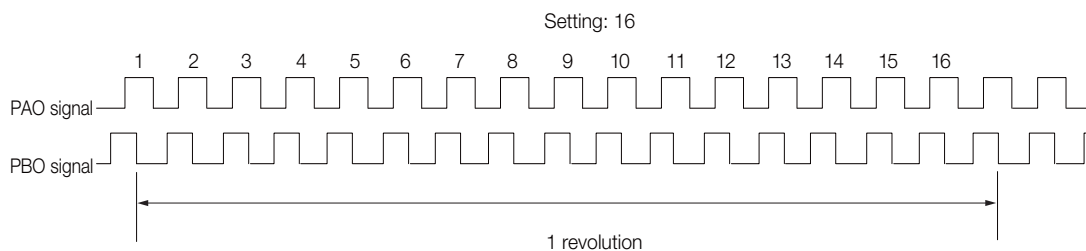

Encoder Divided Pulse Output When Using a Linear Servomotor

If you will use a Linear Servomotor, set the encoder output resolution (Pn281).

Pn281	Encoder Output Resolution				
	Setting Range	Setting Unit	Default Setting	When Enabled	Classification
	1 to 4,096	1 edge/pitch	20	After restart	Setup

- Note: 1. The maximum setting for the encoder output resolution is 4,096.
 If the resolution of the external encoder exceeds 4,096, pulse output will no longer be possible at the resolution given in **Feedback Resolution of Linear Encoder** on page 5-44.
2. If the setting of Pn281 exceeds the resolution of the external encoder, the A.041 alarm (Encoder Output Pulse Setting Error) will be output.

Set the encoder output resolution for the encoder pulse output signals (PAO, /PAO, PBO, and /PBO) from the SERVOPACK to the host controller.

The number of feedback pulses per linear encoder pitch is divided by the setting of Pn281 (after multiplication by 4) inside the SERVOPACK and then the resulting number of pulses is output. Set the parameter according to the system specifications of the machine or host controller.

The setting range depends on the Servomotor's maximum speed (Pn385) and the linear scale pitch (Pn282).* You can calculate the upper limit of the setting of Pn281 with the following formula.

$$\text{Upper limit of Pn281} = \frac{\text{Linear Encoder Pitch} \times 100}{\text{Pn385}} \times 72$$

* The value depends on whether a Serial Converter Unit is used.

Using a Serial Converter Unit	Setting of Pn282
Not Using a Serial Converter Unit (when the linear encoder and SERVOPACK are connected directly or when a linear encoder that does not require a Serial Converter Unit is used)	The linear encoder pitch is automatically detected by the SERVOPACK, so the setting of Pn282 is disabled.

Information When the linear encoder pitch is 4 μm, the maximum motor speed is limited to 1 m/s because of the maximum response frequency of the Serial Converter Unit. If the setting is out of range or does not satisfy the setting conditions, an A.041 alarm (Encoder Output Pulse Setting Error) will be output. If the motor speed exceeds the upper limit for the set encoder output resolution, an A.511 alarm (Encoder Output Pulse Overspeed) will be output. The upper limit of the encoder output resolution is restricted by the dividing specifications of the Serial Converter Unit.

Example **Setting Example**
 Correct setting for a linear encoder pitch of 20 μm and a maximum motor speed of 5 m/s (Pn385 = 50): Pn281 = 28 (edges/pitch)
 Incorrect setting: Pn281 = 29 (edges/pitch) (An A.041 alarm would be output.)

Example **Pulse Output Example**
 When Pn281 = 20 (20-edge output (5-pulse output) per linear encoder pitch)

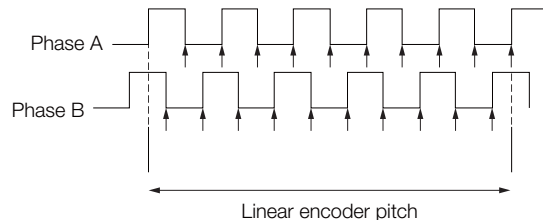

6.6 Internal Torque Limits

You can limit the torque that is output by the Servomotor.

If you use internal torque limits, the maximum output torque will always be limited to the specified forward torque limit (Pn402) and reverse torque limit (Pn403).

Note: If you set a value that exceeds the maximum torque of the Servomotor, the torque will be limited to the maximum torque of the Servomotor.

- Rotary Servomotors

Forward Torque Limit					
Pn402	Setting Range	Setting Unit	Default Setting	When Enabled	Classification
	0 to 800	1%*	800	Immediately	Setup
Reverse Torque Limit					
Pn403	Setting Range	Setting Unit	Default Setting	When Enabled	Classification
	0 to 800	1%*	800	Immediately	Setup

* Set a percentage of the rated motor torque.

Note: If the setting of Pn402 or Pn403 is too low, the torque may be insufficient for acceleration or deceleration of the Servomotor.

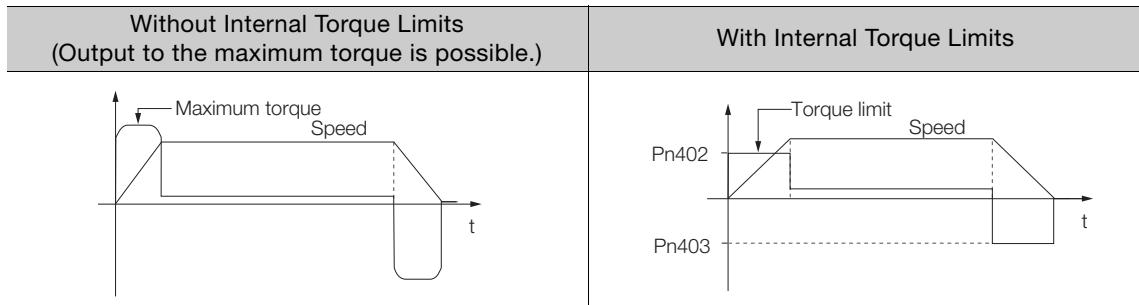

- Linear Servomotors

Forward Force Limit					
Pn483	Setting Range	Setting Unit	Default Setting	When Enabled	Classification
	0 to 800	1%*	30	Immediately	Setup
Reverse Force Limit					
Pn484	Setting Range	Setting Unit	Default Setting	When Enabled	Classification
	0 to 800	1%*	30	Immediately	Setup

* Set a percentage of the rated motor force.

Note: If the setting of Pn483 or Pn484 is too low, the force may be insufficient for acceleration or deceleration of the Servomotor.

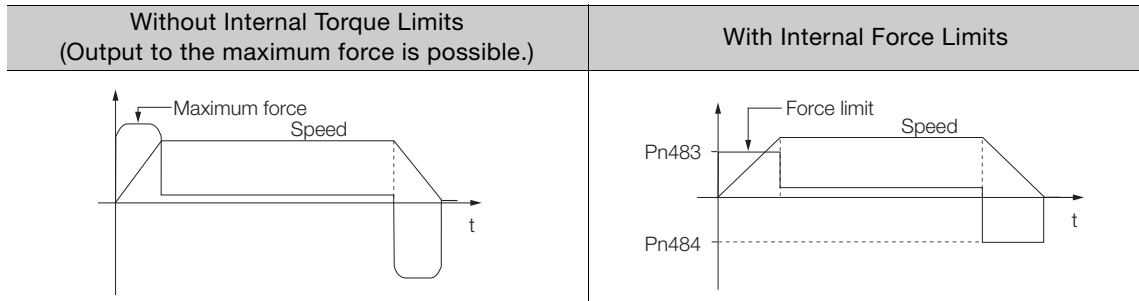

6.7 Absolute Encoders

The absolute encoder records the current position of the stop position even when the power supply is OFF.

With a system that uses an absolute encoder, the host controller can monitor the current position. Therefore, it is not necessary to perform homing when the power supply to the system is turned ON.

There are four types of encoders for Rotary Servomotors. The usage of the encoder is specified in Pn002 = n.□□□□.

SERVOPACKs with software version 0023 or higher support batteryless absolute encoders.

Refer to the following section for encoder models.

 ■ Encoder Resolution on page 5-43

• Parameter Settings When Using an Incremental Encoder

Parameter	Meaning	When Enabled	Classification
Pn002	n.□0□□ (default setting)	After restart	Setup
	n.□1□□		
	n.□2□□		

• Parameter Settings When Using a Single-Turn Absolute Encoder

Parameter	Meaning	When Enabled	Classification
Pn002	n.□0□□ (default setting)	After restart	Setup
	n.□1□□		
	n.□2□□		

• Parameter Settings When Using a Multiturn Absolute Encoder

Parameter	Meaning	When Enabled	Classification
Pn002	n.□0□□ (default setting)	After restart	Setup
	n.□1□□		
	n.□2□□		

• Parameter Settings When Using a Batteryless Multiturn Absolute Encoder

Parameter	Meaning	When Enabled	Classification
Pn002	n.□0□□ (default setting)	After restart	Setup
	n.□1□□		
	n.□2□□		

NOTICE

- Install a battery at either the host controller or on the Encoder Cable.
If you install batteries both at the host controller and on the Encoder Cable at the same time, you will create a loop circuit between the batteries, resulting in a risk of damage or burning.

6.7.1 Connecting an Absolute Encoder

If you use an absolute encoder, the encoder divided pulse output signals (PAO, PBO, and PCO) are output only once when the power supply turns ON. Normally, do not use these signals. You can get the position data from the absolute encoder with MECHATROLINK communications. Therefore, it is not necessary to wire the PAO, PBO, and PCO (Encoder Divided Pulse Output) signals.

If they need to be wired, refer to the following section.

 [4.4.3 Wiring the SERVOPACK to the Encoder on page 4-27](#)

 [I/O Signal Wiring Examples on page 4-38](#)

6.7.2 Multiturn Limit Setting

The multiturn limit is used in position control for a turntable or other rotating body. For example, consider a machine that moves the turntable shown in the following diagram in only one direction.

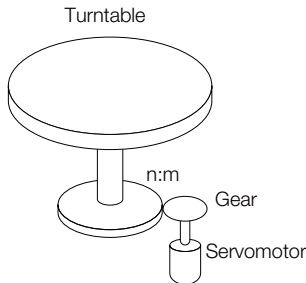

Because the turntable moves in only one direction, the upper limit to the number of rotations that can be counted by an absolute encoder will eventually be exceeded.

The multiturn limit is used in cases like this to prevent fractions from being produced by the integer ratio of the number of Servomotor rotations and the number of turntable rotations.

For a machine with a ratio of n:m between the number of Servomotor rotations and the number of turntable rotations, as shown above, the value of m minus 1 will be the setting for the multiturn limit setting (Pn205).

$$\text{Multiturn limit (Pn205)} = m - 1$$

If $m = 100$ and $n = 3$ (i.e., the turntable rotates three times for each 100 Servomotor rotations), the relationship between the number of Servomotor rotations and the number of turntable rotations would be as shown below.

Set Pn205 to 99.

$$\text{Pn205} = 100 - 1 = 99$$

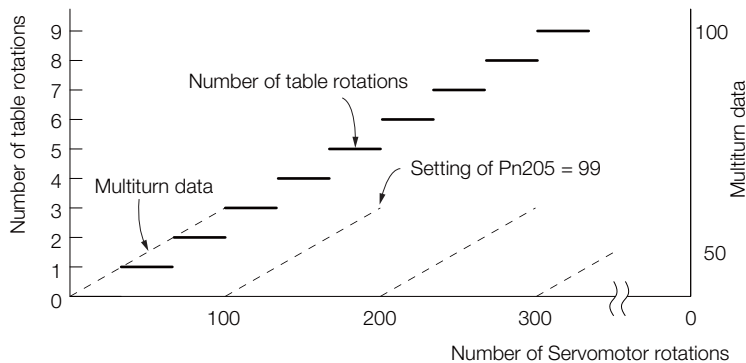

Pn205	Multiturn Limit				
	Setting Range	Setting Unit	Default Setting	When Enabled	Classification
	0 to 65,535	1 Rev	65,535	After restart	Setup

Note: This parameter is enabled when you use an absolute encoder.

The data will change as shown below when this parameter is set to anything other than the default setting.

- If the Servomotor operates in the reverse direction when the multiturn data is 0, the multiturn data will change to the value set in Pn205.
- If the motor operates in the forward direction when the multiturn data is at the value set in Pn205, the multiturn data will change to 0.

Set Pn205 to one less than the desired multiturn data.

If you change the multiturn limit in Pn205, an A.CC0 alarm (Multiturn Limit Disagreement) will be displayed because the setting disagrees with the value in the encoder. Refer to the following section for the procedure to change the multiturn limit settings in the encoder.

6.7.3 Multiturn Limit Disagreement Alarm (A.CC0) on page 6-26

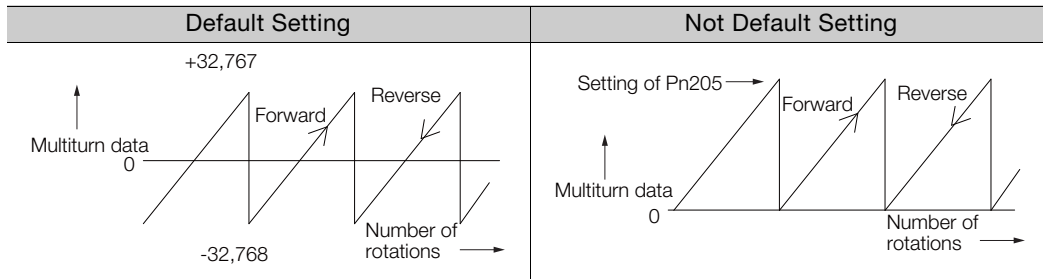

Information The multiturn data will always be 0 in the following cases. It is not necessary to reset the absolute encoder in these cases.

- When you use a single-turn absolute encoder
- When the encoder is set to be used as a single-turn absolute encoder (Pn002 = n.□□□□)

Absolute encoder-related alarms (A.810 and A.820) will not occur.

6.7.3 Multiturn Limit Disagreement Alarm (A.CC0)

If you change the multiturn limit in Pn205 (Multiturn Limit), an A.CC0 alarm (Multiturn Limit Disagreement) will be displayed because the setting disagrees with the value in the encoder.

Display	Name	Alarm Code Output			Meaning
A.CC0	Multiturn Limit Disagreement	/ALO1 ON (low)	/ALO2 OFF (high)	/ALO3 ON (low)	Different multiturn limits are set in the encoder and SERVOPACK.

If this alarm is displayed, use the following procedure to change the multiturn limit in the encoder to the same value as the setting of Pn205.

Applicable Tools

The following table lists the tools that you can use to set the multiturn limit.

Tool	Fn No./Function Name	Operating Procedure Reference
Digital Operator	Fn013	Σ-7-Series Digital Operator Operating Manual (Manual No.: SIEP S800001 33)
SigmaWin+	Encoder Setting – Multi-turn Limit Setting	Operating Procedure on page 6-26
Serial command communications	MLTLIMSET utility command	Monitor and Utility Function Commands on page 14-32

Operating Procedure

Use the following procedure to adjust the multiturn limit setting.

1. Click the Servo Drive Button in the workspace of the Main Window of the SigmaWin+.
2. Select **Multi-turn Limit Setting** in the Menu Dialog Box.
The Multiturn Limit Setting Dialog Box will be displayed.

3. Click the **Continue** Button.

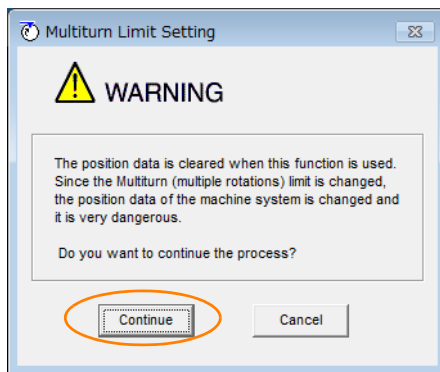

Click the **Cancel** Button to cancel setting the multiturn limit. The Main Window will return.

4. Change the setting.

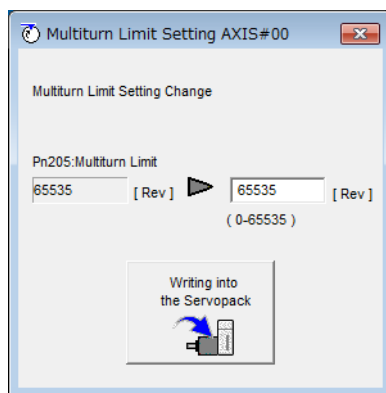

5. Click the **Writing into the Servopack** Button.

6. Click the **OK** Button.

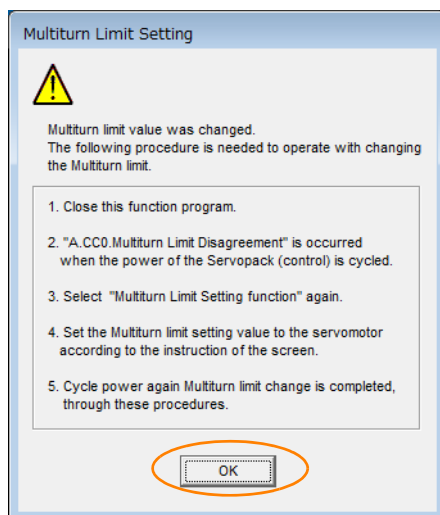

7. Turn the power supply to the **SERVOPACK OFF** and **ON** again.

An A.CC0 alarm (Multiturn Limit Disagreement) will occur because setting the multiturn limit in the Servomotor is not yet completed even though the setting has been changed in the SERVOPACK.

8. Display the Multiturn Limit Setting in the Menu Dialog Box.

9. Click the **Continue** Button.

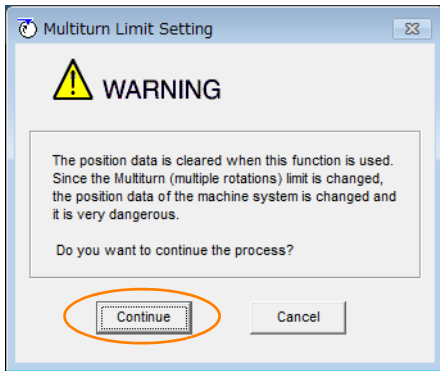

10. Click the **Writing into the Motor** Button.

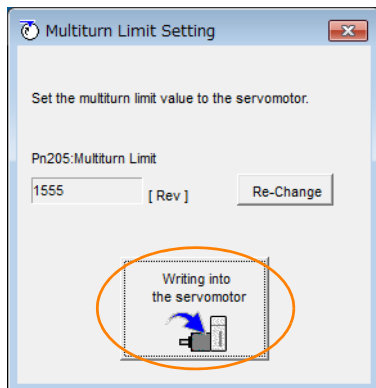

Click the **Re-change** Button to change the setting.

11. Click the **OK** Button.

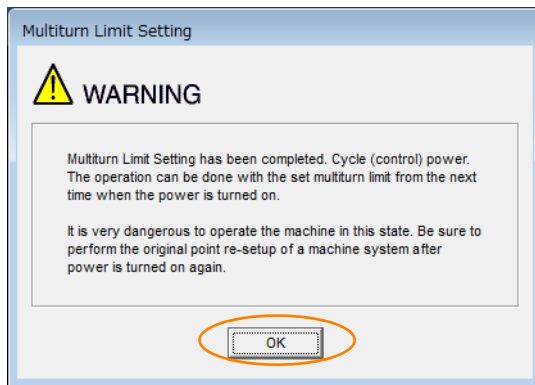

This concludes the procedure to set the multiturn limit.

6.8

Absolute Linear Encoders

The absolute linear encoder records the current position of the stop position even when the power supply is OFF.

With a system that uses an absolute linear encoder, the host controller can monitor the current position. Therefore, it is not necessary to perform homing when the power supply to the system is turned ON.

There are three types of linear encoders for Linear Servomotors. The usage of the linear encoder is specified in Pn002 = n.□X□□.

Refer to the following section for linear encoder models.

 ■ *Feedback Resolution of Linear Encoder* on page 5-44

- Parameter Settings When Using an Incremental Linear Encoder

Parameter		Meaning	When Enabled	Classification
Pn002	n.□0□□ (default setting)	Use the encoder as an incremental linear encoder.	After restart	Setup
	n.□1□□	Use the encoder as an incremental linear encoder.		

- Parameter Settings When Using an Absolute Linear Encoder

Parameter		Meaning	When Enabled	Classification
Pn002	n.□0□□ (default setting)	Use the encoder as an absolute linear encoder.	After restart	Setup
	n.□1□□	Use the encoder as an incremental linear encoder.		

6.8.1

Connecting an Absolute Linear Encoder

If you use an absolute linear encoder, the encoder divided pulse output signals (PAO, PBO, and PCO) are output only once when the power supply turns ON. Normally, do not use these signals. You can get the position data from the absolute linear encoder with MECHATROLINK communications. Therefore, it is not necessary to wire the PAO, PBO, and PCO (Encoder Divided Pulse Output) signals.

If they need to be wired, refer to the following section.

 4.4.3 *Wiring the SERVOPACK to the Encoder* on page 4-27

 *I/O Signal Wiring Examples* on page 4-38

6.9 Software Reset

You can reset the SERVOPACK internally with the software. A software reset is used when resetting alarms and changing the settings of parameters that normally require turning the power supply to the SERVOPACK OFF and ON again. This can be used to change those parameters without turning the power supply to the SERVOPACK OFF and ON again.

Information

1. Always confirm that the servo is OFF and that the Servomotor is stopped before you start a software reset.
2. This function resets the SERVOPACK independently of the host controller. The SERVOPACK carries out the same processing as when the power supply is turned ON and outputs the ALM (Servo Alarm) signal. The status of other output signals may be forcibly changed.
3. When you execute a software reset, the SERVOPACK will not respond for approximately five seconds.
Before you execute a software reset, check the status of the SERVOPACK and Servomotor and make sure that no problems will occur.



6.9.1 Preparations

Always check the following before you perform a software reset.

- The servo must be OFF.
- The motor must be stopped.

6.9.2 Applicable Tools

The following table lists the tools that you can use to perform a software reset.

Tool	Fn No./Function Name	Operating Procedure Reference
Digital Operator	Fn030	 Σ -7-Series Digital Operator Operating Manual (Manual No.: SIEP S800001 33)
SigmaWin+	Basic Functions – Software Reset	 6.9.3 Operating Procedure on page 6-30
Serial command communications	RES basic operation command	 14.8.1 Basic Operation Commands on page 14-11

6.9.3 Operating Procedure

Use the following procedure to perform a software reset.

1. Click the  Servo Drive Button in the workspace of the Main Window of the SigmaWin+.
2. Select **Software Reset** in the Menu Dialog Box.
The Software Reset Dialog Box will be displayed.

3. Click the **Execute** Button.

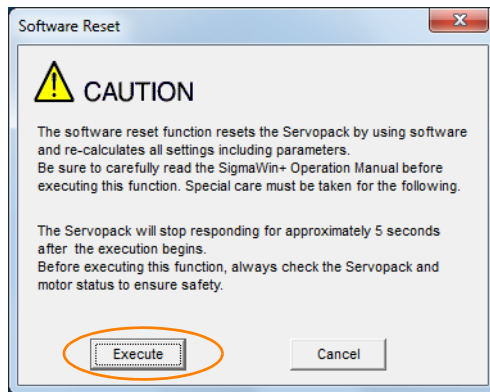

Click the **Cancel** Button to cancel the software reset. The Main Window will return.

4. Click the **Execute** Button.

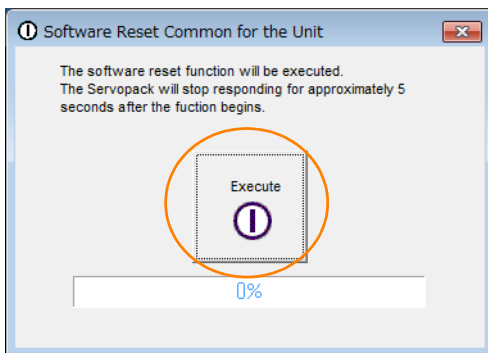

5. Click the **OK** Button to end the software reset operation.

All settings including parameters will have been re-calculated. When you finish this operation, disconnect the SigmaWin+ from the SERVOPACK, and then connect it again.



This concludes the procedure to reset the software.

6.10 Initializing the Vibration Detection Level

You can detect machine vibration during operation to automatically adjust the settings of Pn312 or Pn384 (Vibration Detection Level) to detect A.520 alarms (Vibration Alarm) and A.911 warnings (Vibration Warning) more precisely.

This function detects specific vibration components in the Servomotor speed.

Parameter		Meaning	When Enabled	Classification
Pn310	n.□□□0 (default setting)	Do not detect vibration.	Immediately	Setup
	n.□□□1	Output a warning (A.911) if vibration is detected.		
	n.□□□2	Output an alarm (A.520) if vibration is detected.		

If the vibration exceeds the detection level calculated with the following formula, an alarm or warning occurs according to Pn310 (Vibration Detection Selection).

- Rotary Servomotors

$$\text{Detection level} = \frac{\text{Vibration detection level (Pn312 [min-1])} \times \text{Vibration detection sensitivity (Pn311 [\%])}{100}$$

- Linear Servomotors

$$\text{Detection level} = \frac{\text{Vibration detection level (Pn384 [mm/s])} \times \text{Vibration detection sensitivity (Pn311 [\%])}{100}$$

Use this function only if A.520 or A.911 alarms are not output at the correct times when vibration is detected with the default vibration detection level (Pn312 or Pn384).

There will be discrepancies in the detection sensitivity for vibration alarms and warnings depending on the condition of your machine. If there is a discrepancy, use the above formula to adjust Pn311 (Vibration Detection Sensitivity).

Pn311	Vibration Detection Sensitivity				
	Setting Range	Setting Unit	Default Setting	When Enabled	Classification
	50 to 500	1%	100	Immediately	Tuning

Information

1. Vibration may not be detected because of unsuitable servo gains. Also, not all kinds of vibrations can be detected.
2. Set a suitable moment of inertia ratio (Pn103). An unsuitable setting may result in falsely detecting or not detecting vibration alarms or vibration warnings.
3. To use this function, you must input the actual references that will be used to operate your system.
4. Execute this function under the operating conditions for which you want to set the vibration detection level.
5. Execute this function while the Servomotor is operating at 10% of its maximum speed or faster.



6.10.1 Preparations

Always check the following before you initialize the vibration detection level.

- The parameters must not be write prohibited.
- The test without a motor function must be disabled (Pn00C = n.□□□0).

6.10.2 Applicable Tools

The following table lists the tools that you can use to initialize the vibration detection level.

Tool	Fn No./Function Name	Operating Procedure Reference
Digital Operator	Fn01B	 Σ -7-Series Digital Operator Operating Manual (Manual No.: SIEP S800001 33)
SigmaWin+	Others – Initialize Vibration Detection Level	 6.10.3 Operating Procedure on page 6-33

6.10.3 Operating Procedure

Use the following procedure to initialize the vibration detection level.

1. Click the  Servo Drive Button in the workspace of the Main Window of the SigmaWin+.
2. Select **Initialize Vibration Detection Level** in the Menu Dialog Box.
The Initialize Vibration Detection Level Dialog Box will be displayed.
3. Select **Pn311: Vibration Detection Sensitivity** and **Pn310: Vibration Detection Selections** and then click the **Detection Start** Button.
A setting execution standby mode will be entered.

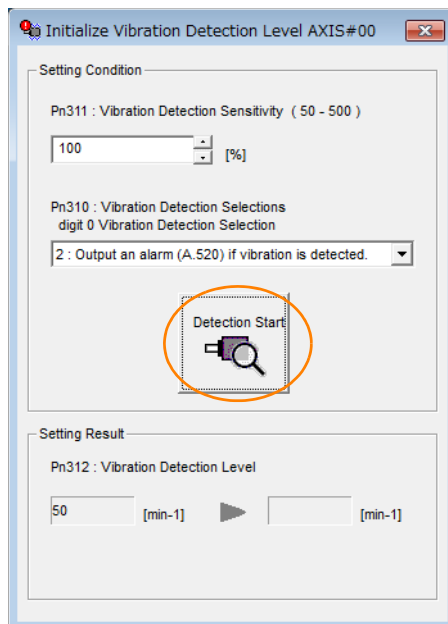

4. Click the **Execute** Button.

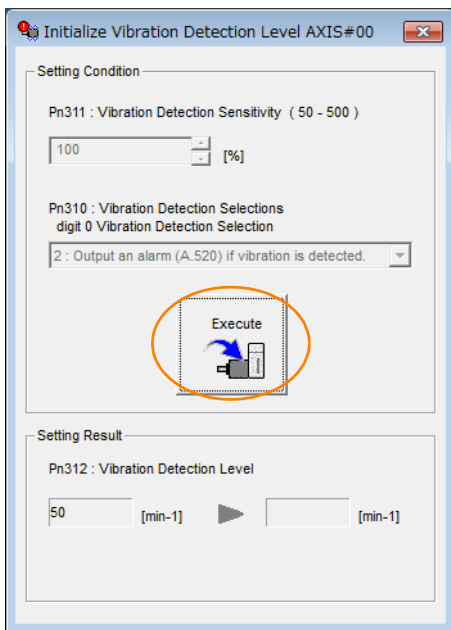

The newly set vibration detection level will be displayed and the value will be saved in the SERVO-PACK.

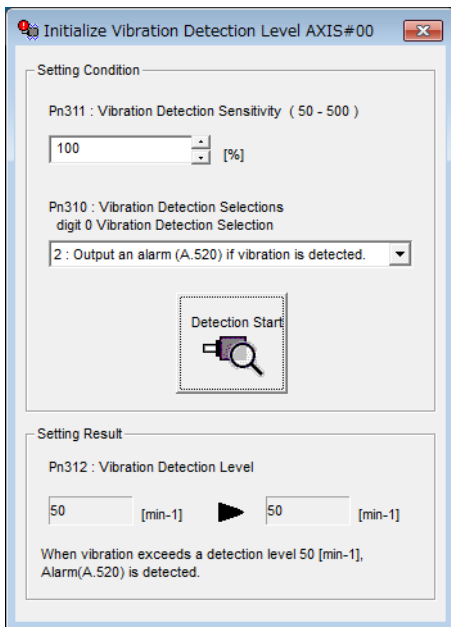

This concludes the procedure to initialize the vibration detection level.

6.10.4 Related Parameters

The following three items are given in the following table.

- Parameters Related to this Function
These are the parameters that are used or referenced when this function is executed.
- Changes during Function Execution
Not allowed: The parameter cannot be changed using the SigmaWin+ or other tool while this function is being executed.
Allowed: The parameter can be changed using the SigmaWin+ or other tool while this function is being executed.
- Automatic Changes after Function Execution
Yes: The parameter is automatically set or adjusted after execution of this function.
No: The parameter is not automatically set or adjusted after execution of this function.

Parameter	Name	Setting Changes	Automatic Changes
Pn311	Vibration Detection Sensitivity	Allowed	No
Pn312	Vibration Detection Level	Not allowed	Yes
Pn384	Vibration Detection Level	Not allowed	Yes

6.11 Adjusting the Motor Current Detection Signal Offset

The motor current detection signal offset is used to reduce ripple in the torque. You can adjust the motor current detection signal offset either automatically or manually.

6.11.1 Automatic Adjustment

Perform this adjustment only if highly accurate adjustment is required to reduce torque ripple. It is normally not necessary to adjust this offset.



Important

Execute the automatic offset adjustment if the torque ripple is too large when compared with other SERVOPACKs.

Information

The offset does not use a parameter, so it will not change even if the parameter settings are initialized.

Preparations

Always check the following before you automatically adjust the motor current detection signal offset.

- The parameters must not be write prohibited.
- The servo must be in ready status.
- The servo must be OFF.

Applicable Tools

The following table lists the tools that you can use to automatically adjust the offset.

Tool	Fn No./Function Name	Operating Procedure Reference
Digital Operator	Fn00E	Σ -7-Series Digital Operator Operating Manual (document No. SIEP S800001 33)
SigmaWin+	<i>Others – Adjust the Motor Current Detection Offset</i>	<i>Operating Procedure</i> on page 6-36
Serial command communications	CURZERO utility command	<i>Monitor and Utility Function Commands</i> on page 14-32

Operating Procedure

Use the following procedure to automatically adjust the motor current detection signal offset.

1. Click the Servo Drive Button in the workspace of the Main Window of the SigmaWin+.
2. Select **Adjust the Motor Current Detection Offset** in the Menu Dialog Box.
The Adjust the Motor Current Detection Signal Offsets Dialog Box will be displayed.

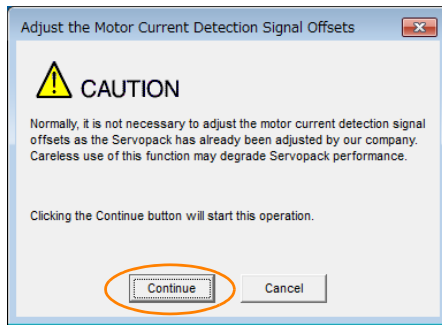
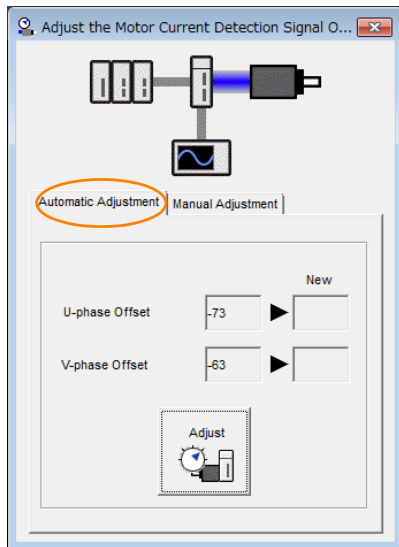
3. Click the **Continue** Button.4. Click the **Automatic Adjustment** Tab in the Adjust the Motor Current Detection Signal Offsets Dialog Box.5. Click the **Adjust** Button.

The values that result from automatic adjustment will be displayed in the **New** Boxes.

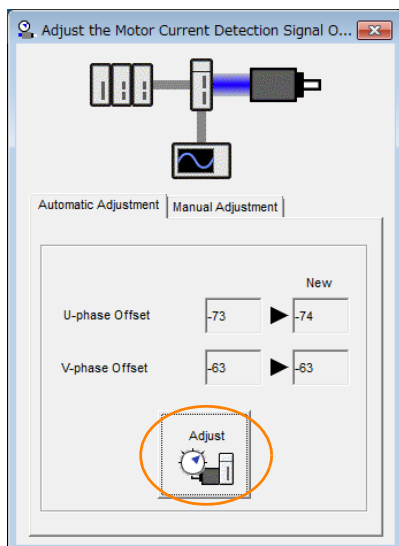

This concludes the procedure to automatically adjust the motor current detection signal offset.

6.11.2 Manual Adjustment

You can use this function if you automatically adjust the motor current detection signal offset and the torque ripple is still too large.



Important

If the offset is incorrectly adjusted with this function, the Servomotor characteristics may be adversely affected.

Observe the following precautions when you manually adjust the offset.

- Operate the Servomotor at a speed of approximately 100 min^{-1} .
- Adjust the offset while monitoring the torque reference with the analog monitor until the ripple is minimized.
- Adjust the offsets for the phase-U current and phase-V current of the Servomotor so that they are balanced. Alternately adjust both offsets several times.

Information

The offset does not use a parameter, so it will not change even if the parameter settings are initialized.

Preparations

Always check the following before you manually adjust the motor current detection signal offset.

- The parameters must not be write prohibited.

Applicable Tools

The following table lists the tools that you can use to manually adjust the offset.

Tool	Fn No./Function Name	Operating Procedure Reference
Digital Operator	Fn00F	Σ -7-Series Digital Operator Operating Manual (Manual No.: SIEP S80001 33)
SigmaWin+	<i>Others – Adjust the Motor Current Detection Offset</i>	Operating Procedure on page 6-38

Operating Procedure

Use the following procedure to manually adjust the motor current detection signal offset.

1. Operate the Servomotor at approximately 100 min^{-1} .
2. Click the Servo Drive Button in the workspace of the Main Window of the SigmaWin+.
3. Select **Adjust the Motor Current Detection Offset** in the Menu Dialog Box. The Adjust the Motor Current Detection Signal Offsets Dialog Box will be displayed.
4. Click the **Continue** Button.

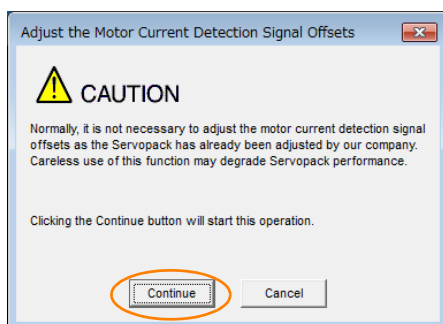

- Click the **Manual Adjustment** Tab in the Adjust the Motor Current Detection Signal Offsets Dialog Box.

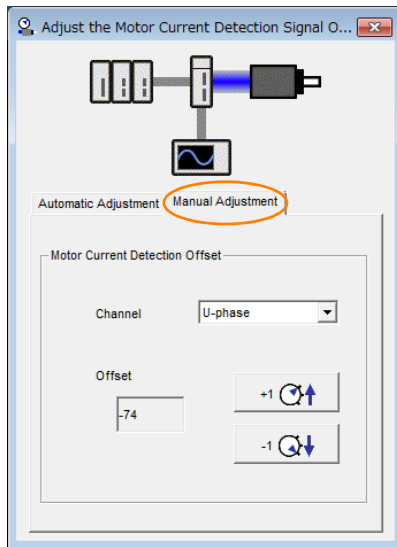

- Set the **Channel** Box in the **Motor Current Detection Offset** Area to **U-phase**.
- Use the **+1** and **-1** Buttons to adjust the offset for phase U.
Change the offset by about 10 in the direction that reduces the torque ripple.
Adjustment range: -512 to +511
- Set the **Channel** Box in the **Motor Current Detection Offset** Area to **V-phase**.
- Use the **+1** and **-1** Buttons to adjust the offset for phase V.
Change the offset by about 10 in the direction that reduces the torque ripple.
- Repeat steps 6 to 9 until the torque ripple cannot be decreased any further regardless of whether you increase or decrease the offsets.
- Reduce the amount by which you change the offsets each time and repeat steps 6 to 9.

This concludes the procedure to manually adjust the motor current detection signal offset.

6.12 Overheat Protection

Overheat protection detects an A.93B warning (Overheat Warning) and an A.862 alarm (Overheat Alarm) by monitoring the overheat protection input signal from a Yaskawa SGLFW2 Linear Servomotor or from a sensor attached to the machine.

SERVOPACKs with software version 0023 or higher support overheat protection.

When you use overheat protection, you must wire the overheat protection input (TH) signal and select overheat protection (Pn61A = n.□□□X).

6.12.1 Connecting the Overheat Protection Input (TH) Signal

To use overheat protection, you must connect an overheat protection input (TH) signal to the SERVOPACK. This section describes the connection methods for the overheat protection input (TH) signal.

Using Overheat Protection in the Linear Servomotor

◆ When Using a Serial Converter Unit

Connect the connector for the polarity sensor (hall sensor) and thermal protector of the linear servomotor to the serial converter unit.

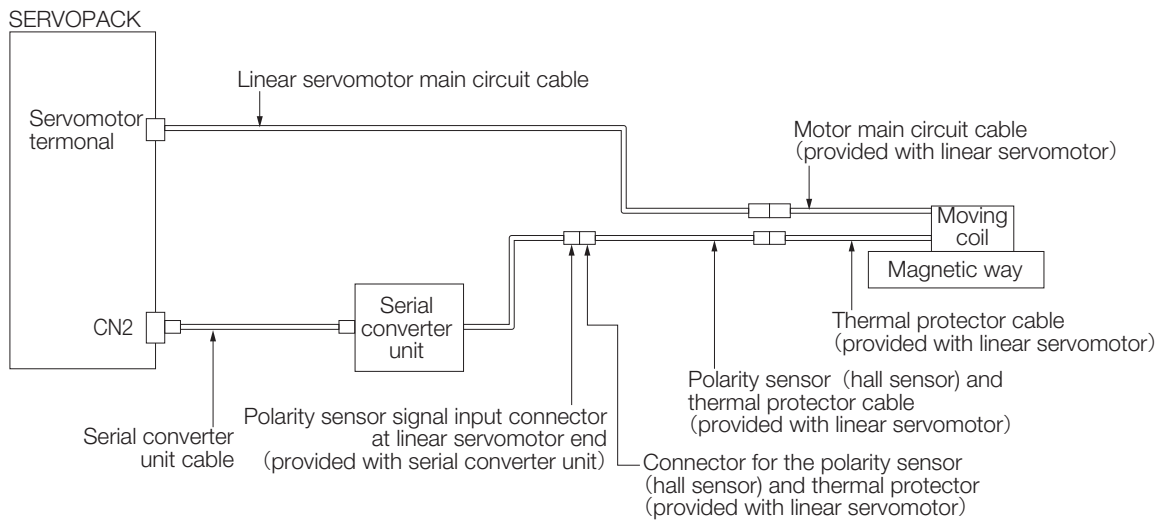

Using Overheat Protection for the Machine

To use overheat protection for the machine, connect the overheat protection input (an analog voltage input) from the sensor mounted to the machine to the CN1-5 on the SERVOPACK.

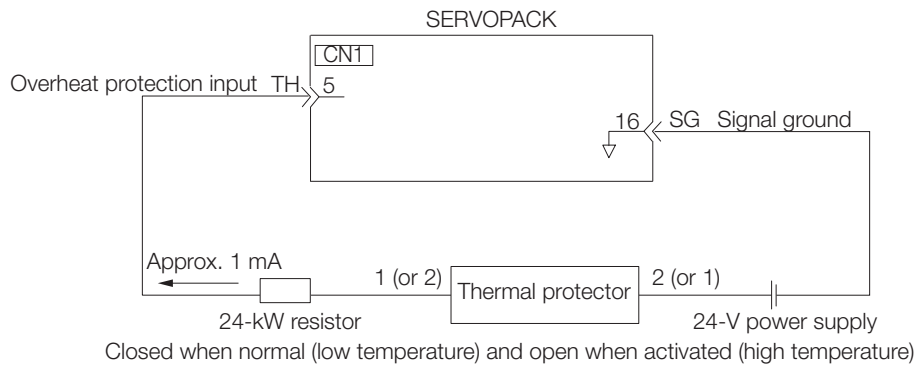

Important

- The recommended length of the thermal protector cable is 15 m maximum.
- The 24-V power supply and 24-kΩ resistor are not provided by Yaskawa. Use a 0.3 W or greater 24-V power supply, and use a 0.2 W or greater 24-kΩ resistor.
- Be sure to connect the positive and negative sides of the power supply correctly. Otherwise there is a risk of SERVOPACK failure.

6.12.2 Overheat Protection Selection

The overheat protection function is selected with Pn61A = n.□□□X (Overheat Protection Selections).

Parameter	Meaning	When Enabled	Classification
Pn61A	n.□□□0 (default setting)	Disable overheat protection.	After restart Setup
	n.□□□1	Use overheat protection in the Yaskawa Linear Servomotor.*	
	n.□□□2	Monitor a negative voltage input from a sensor attached to the machine and use overheat protection.	
	n.□□□3	Monitor a positive voltage input from a sensor attached to the machine and use overheat protection.	

* The SGLFW2 is the only Yaskawa Linear Servomotor that supports this function.

Using Overheat Protection in the Yaskawa Linear Servomotor

To use the overheat protection in the Yaskawa Linear Servomotor (SGLFW2), set Pn61A to n.□□□1.

An A.93B warning (Overheat Warning) will be detected if the overheat protection input (TH) signal from the Yaskawa SGLFW2 Linear Servomotor exceeds the warning temperature.

An A.862 alarm (Overheat Alarm) will be detected if the overheat protection input (TH) signal from the Yaskawa SGLFW2 Linear Servomotor exceeds the alarm temperature.



Important

- If the overheat protection input signal line is disconnected or short-circuited, an A.862 alarm will occur.
- If you set Pn61A to n.□□□1 (Use overheat protection in the Yaskawa Linear Servomotor), the parameters in the Servomotor are enabled and the following parameters are disabled.
 - Overheat Alarm Level (Pn61B)
 - Overheat Warning Level (Pn61C)
 - Overheat Alarm Filter Time (Pn61D)

Monitoring the Machine's Temperature and Using Overheat Protection

Set Pn61A = n.□□□X to 2 or 3 to use overheat protection for the machine.

Set the following parameters as required.

Pn61B	Overheat Alarm Level				
	Setting Range	Setting Unit	Default Setting	When Enabled	Classification
	0 to 500	0.01 V	250	Immediately	Setup
Pn61C	Overheat Warning Level				
	Setting Range	Setting Unit	Default Setting	When Enabled	Classification
	0 to 100	1%	100	Immediately	Setup
Pn61D	Overheat Alarm Filter Time				
	Setting Range	Setting Unit	Default Setting	When Enabled	Classification
	0 to 65,535	1 s	0	Immediately	Setup



Important

- When Pn61A is set to n.□□□2, an A.862 alarm will occur if the overheat protection input signal line is disconnected or short-circuited.
- When Pn61A is set to n.□□□3, an A.862 alarm will not occur if the overheat protection input signal line is disconnected or short-circuited. To ensure safety, we recommend that you connect the external circuits so that you can use a negative voltage input for the overheat protection input (an analog voltage input).

Trial Operation

7

This chapter provides information on the flow and procedures for trial operation and convenient functions to use during trial operation.

7.1	Flow of Trial Operation	7-2
7.1.1	Flow of Trial Operation for Rotary Servomotors . .	7-2
7.1.2	Flow of Trial Operation for Linear Servomotors . .	7-3
7.2	Inspections and Confirmations before Trial Operation . .	7-5
7.3	Trial Operation for the Servomotor without a Load . .	7-6
7.3.1	Preparations	7-6
7.3.2	Applicable Tools	7-7
7.3.3	Operating Procedure	7-7
7.4	Trial Operation with Digital I/O and Serial Communications . . .	7-9
7.5	Trial Operation with the Servomotor Connected to the Machine . .	7-11
7.5.1	Precautions	7-11
7.5.2	Preparations	7-11
7.5.3	Operating Procedure	7-12
7.6	Convenient Function to Use during Trial Operation . .	7-13
7.6.1	Program Jog Operation	7-13
7.6.2	Origin Search	7-19
7.6.3	Test without a Motor	7-21

7.1 Flow of Trial Operation

7.1.1 Flow of Trial Operation for Rotary Servomotors

The procedure for trial operation is given below.

• Preparations for Trial Operation

Step	Meaning	Reference
1	Installation Install the Servomotor and SERVOPACK according to the installation conditions. First, operation is checked with no load. Do not connect the Servomotor to the machine.	<i>Chapter 3 Installation</i>
2	Wiring and Connections Wire and connect the SERVOPACK. First, Servomotor operation is checked without a load. Do not connect the CN1 connector on the SERVOPACK.	<i>Chapter 4 Wiring and Connecting</i>
3	Confirmations before Trial Operation	<i>7.2 Inspections and Confirmations before Trial Operation on page 7-5</i>
4	Power ON	—
5	Resetting the Absolute Encoder This step is necessary only for a Servomotor with an Absolute Encoder.	<i>5.15 Resetting the Absolute Encoder on page 5-48</i>

• Trial Operation

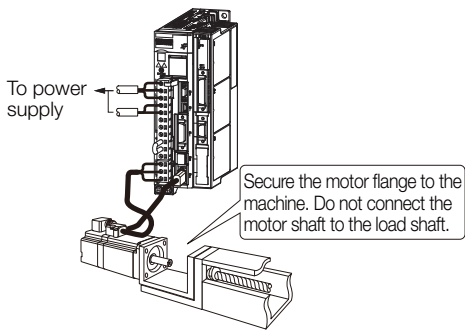
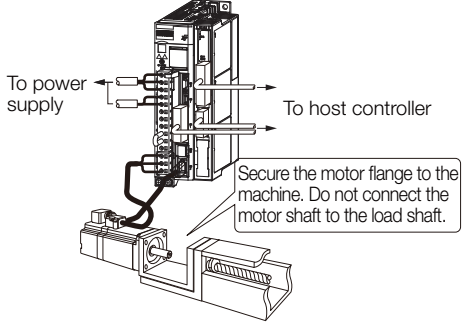
Step	Meaning	Reference
1	Trial Operation for the Servomotor without a Load 	<i>7.3 Trial Operation for the Servomotor without a Load on page 7-6</i>
2	Trial Operation with Digital I/O and Serial Communications 	<i>7.4 Trial Operation with Digital I/O and Serial Communications on page 7-9</i>

Continued on next page.

Continued from previous page.

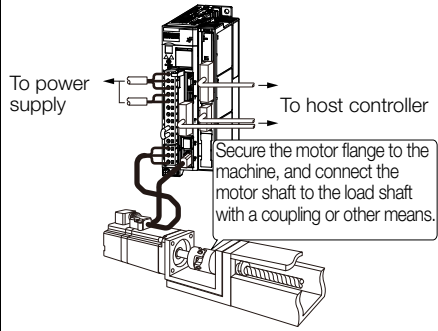
Step	Meaning	Reference
3	<p>Trial Operation with the Servomotor Connected to the Machine</p> 	<p>7.5 <i>Trial Operation with the Servomotor Connected to the Machine</i> on page 7-11</p>

7.1.2 Flow of Trial Operation for Linear Servomotors

The procedure for trial operation is given below.

- Preparations for Trial Operation

Step	Meaning	Reference			
1	<p>Installation Install the Servomotor and SERVOPACK according to the installation conditions. First, operation is checked with no load. Do not connect the Servomotor to the machine.</p>	<p><i>Chapter 3 Installation</i></p>			
2	<p>Wiring and Connections Wire and connect the SERVOPACK. First, Servomotor operation is checked without a load. Do not connect the CN1 connector on the SERVOPACK.</p>	<p><i>Chapter 4 Wiring and Connecting</i></p>			
3	<p>Confirmations before Trial Operation</p>	<p>7.2 <i>Inspections and Confirmations before Trial Operation</i> on page 7-5</p>			
4	<p>Power ON</p>	<p>–</p>			
5	<p>Setting Parameters in the SERVOPACK</p>				
	Step	No. of Parameter to Set	Description	Remarks	Reference
	5-1	Pn282	Linear Encoder Pitch	Set this parameter only if you are using a Serial Converter Unit.	page 5-16
	5-2	–	Writing Parameters to the Linear Servomotor	Set this parameter only if you are not using a Serial Converter Unit.	page 5-17
	5-3	Pn080 = n.□□X□	Motor Phase Sequence Selection	–	page 5-21
	5-4	Pn080 = n.□□□X	Polarity Sensor Selection	–	page 5-23
	5-5	–	Polarity Detection	This step is necessary only for a Linear Servomotor with a Polarity Sensor.	page 5-24
	5-6	PnB0F and PnB10	Overtravel Signal Allocations	–	page 5-27
5-7	Pn483, Pn484	Force Control	–	page 6-22	
6	<p>Setting the Origin of the Absolute Linear Encoder</p>	<p>5.16 <i>Setting the Origin of the Absolute Linear Encoder</i> on page 5-51</p>			

• Trial Operation

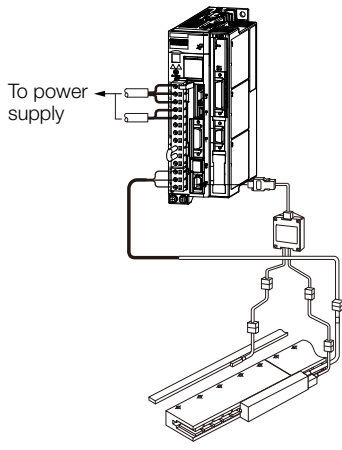
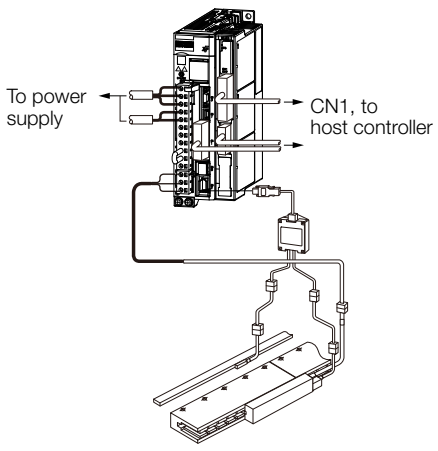
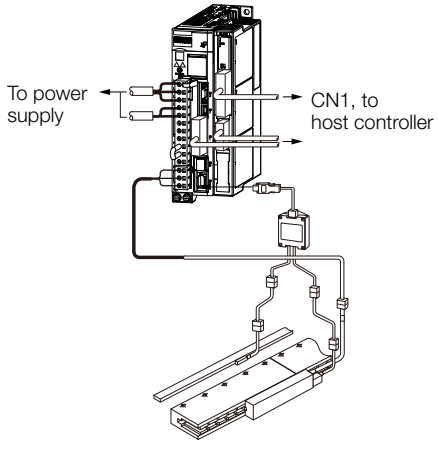
Step	Meaning	Reference
1	<p>Trial Operation for the Servomotor without a Load</p> 	<p>7.3 Trial Operation for the Servomotor without a Load on page 7-6</p>
2	<p>Trial Operation with Digital I/O and Serial Communications</p> 	<p>7.4 Trial Operation with Digital I/O and Serial Communications on page 7-9</p>
3	<p>Trial Operation with the Servomotor Connected to the Machine</p> 	<p>7.5 Trial Operation with the Servomotor Connected to the Machine on page 7-11</p>

Continued on next page.

7.2

Inspections and Confirmations before Trial Operation

To ensure safe and correct trial operation, check the following items before you start trial operation.

- Make sure that the SERVOPACK and Servomotor are installed, wired, and connected correctly.
- Make sure that the correct power supply voltage is supplied to the SERVOPACK.
- Make sure that there are no loose parts in the Servomotor mounting.
- If you are using a Servomotor with an Oil Seal, make sure that the oil seal is not damaged. Also make sure that oil has been applied.
- If you are performing trial operation on a Servomotor that has been stored for a long period of time, make sure that all Servomotor inspection and maintenance procedures have been completed.

Refer to the manual for your Servomotor for Servomotor maintenance and inspection information.

- If you are using a Servomotor with a Holding Brake, make sure that the brake is released in advance. To release the brake, you must apply the specified voltage of 24 VDC to the brake. A circuit example for trial operation is provided below.

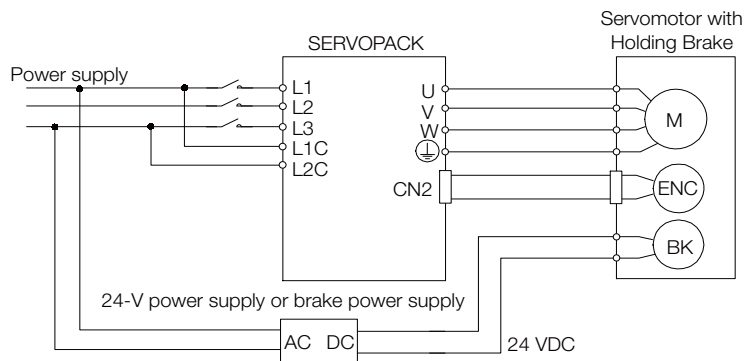

7.3 Trial Operation for the Servomotor without a Load

You use jog operation for trial operation of the Servomotor without a load.

Jog operation is used to check the operation of the Servomotor without connecting the SERVO-PACK to the host controller. The Servomotor is moved at the preset jog operation speed.

CAUTION

- During jog operation, the overtravel function is disabled. Consider the range of motion of your machine when you jog the Servomotor.

The tuning-less function is enabled as the default setting. When the tuning-less function is enabled, gain will increase and vibration may occur if the Servomotor is operated with no load. If vibration occurs, disable the tuning-less function (Pn170 = n.□□□0).

7.3.1 Preparations

Always check the following before you execute jog operation.

- The parameters must not be write prohibited.
- The main circuit power supply must be ON.
- There must be no alarms.
- There must be no hard wire base block (HWBB).
- The servo must be OFF.
- The jog operation speed must be set considering the operating range of the machine. The jog operation speed is set with the following parameters.

- Rotary Servomotors

Pn304	Jog Operation Speed				
	Setting Range	Setting Unit	Default Setting	When Enabled	Classification
	0 to 10,000	1 min ⁻¹	500	Immediately	Setup
Pn305	Soft Start Acceleration Time				
	Setting Range	Setting Unit	Default Setting	When Enabled	Classification
	0 to 10,000	1 ms	0	Immediately	Setup
Pn306	Soft Start Deceleration Time				
	Setting Range	Setting Unit	Default Setting	When Enabled	Classification
	0 to 10,000	1 ms	0	Immediately	Setup

- Direct Drive Servomotors



Pn304	Jog Operation Speed				
	Setting Range	Setting Unit	Default Setting	When Enabled	Classification
	0 to 10,000	0.1 min ⁻¹	500	Immediately	Setup
Pn305	Soft Start Acceleration Time				
	Setting Range	Setting Unit	Default Setting	When Enabled	Classification
	0 to 10,000	1 ms	0	Immediately	Setup
Pn306	Soft Start Deceleration Time				
	Setting Range	Setting Unit	Default Setting	When Enabled	Classification
	0 to 10,000	1 ms	0	Immediately	Setup

- Linear Servomotors

Pn383	Jog Operation Speed				
	Setting Range	Setting Unit	Default Setting	When Enabled	Classification
	0 to 10,000	1 mm/s	50	Immediately	Setup
Pn305	Soft Start Acceleration Time				
	Setting Range	Setting Unit	Default Setting	When Enabled	Classification
	0 to 10,000	1 ms	0	Immediately	Setup
Pn306	Soft Start Deceleration Time				
	Setting Range	Setting Unit	Default Setting	When Enabled	Classification
	0 to 10,000	1 ms	0	Immediately	Setup

7.3.2 Applicable Tools

The following table lists the tools that you can use to perform jog operation.

Tool	Fn No./Function Name	Operating Procedure Reference
Digital Operator	Fn002	 Σ -7-Series Digital Operator Operating Manual (Manual No.: SIEP S800001 33)
SigmaWin+	Operation – Jog	 Operating Procedure on page 7-7

7.3.3 Operating Procedure

Use the following procedure for a jog operation.

- Click the  Servo Drive Button in the workspace of the Main Window of the SigmaWin+.
- Select **JOG Operation** in the Menu Dialog Box.
The Jog Operation Dialog Box will be displayed.
- Read the warnings and then click the **OK** Button.

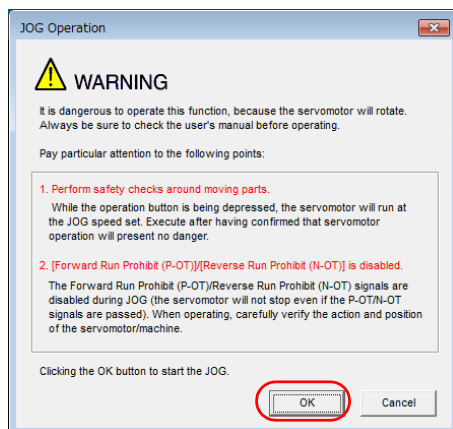

4. Check the jog operation speed and then click the **Servo ON** Button.

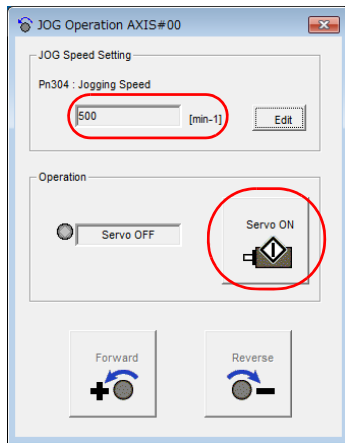

The display in the **Operation** Area will change to **Servo ON**.

Information To change the speed, click the **Edit** Button and enter the new speed.

5. Click the **Forward** Button or the **Reverse** Button.

Jog operation will be performed only while you hold down the mouse button.

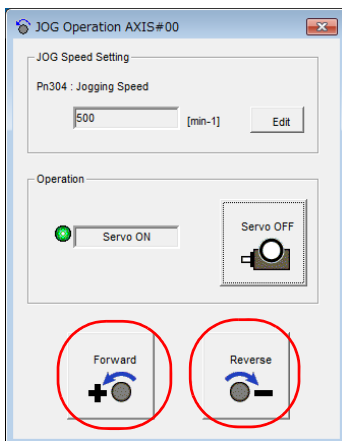

6. After you finish jog operation, turn the power supply to the SERVOPACK OFF and ON again.

This concludes the jog operation procedure.

7.4

Trial Operation with Digital I/O and Serial Communications

This section provides an example of trial operation with digital I/O and serial command communications. Refer to the following sections for information on operation with digital I/O and operation with serial command communications.

 [Chapter 13 Operation with Digital I/O](#)

 [Chapter 14 Operation with Serial Command Communications](#)

1. Confirm that the wiring is correct, and then connect the I/O signal connectors (CN1 and CN11 connectors).

Refer to the following chapter for details on wiring.

 [Chapter 4 Wiring and Connecting](#)

2. Turn ON the power supplies to the SERVOPACK.

If power is being supplied correctly, the CHARGE indicator on the SERVOPACK and the green indicator on the INDEXER Module will light.



If the green indicator on the INDEXER Module does not light and the red indicator lights, an alarm has occurred.

Refer to the following section to reset the alarm.





 [15.2 Alarm Displays](#) on page 15-5

3. Set the following items, which are necessary for trial operation.

Program Table Operation

Setting	Reference
Electronic Gear	 5.14 Electronic Gear Settings on page 5-41
Motor Direction	 5.4 Motor Direction Setting on page 5-15
Overtravel	 5.10 Overtravel and Related Settings on page 5-27

Serial Command Communications

Setting	Reference
Electronic Gear	 5.14 Electronic Gear Settings on page 5-41
Motor Direction	 5.4 Motor Direction Setting on page 5-15
Overtravel	 5.10 Overtravel and Related Settings on page 5-27
Parameters for Serial Communications	 14.3.3 Parameters Related to Serial Communications on page 14-6

4. If you will use serial command communications, confirm that communications are performed normally.

Send the ALM command and confirm that the following acknowledgment is returned. If it is, then communications are normal.

Serial Command	Acknowledgment
ALM	ALM[SP]BB[SP][SP][SP][CR][LF]

5. Input the /S-ON (Servo ON) signal or send the SVON command.

The servo will turn ON. OK will be returned if you send the SVON command. Send the ALM command and confirm that the following acknowledgment is returned. If it is, then the servo is ON.

Serial Command	Acknowledgment
ALM	ALM[SP]INPOS[CR][LF]

6. Operate the Servomotor at low speed.

Program Table Operation



PGM-STEP	POS	SPD	RDST	RSPD	ACC	DEC	POUT	EVENT	LOOP	NEXT
0	I+10000	1000	-	1000	:	:	IT0	1	END

Serial Command Communications

SPD1000: Positioning speed specification of 1,000 [1,000 reference units/min]

STI+10000: Target position specification and starting positioning, Target position of +10,000 [reference units]

7. While operation is in progress for step 6, confirm the following items.

Confirmation Item	Reference
Confirm that the rotational direction of the Servomotor agrees with the forward or reverse reference. If they do not agree, correct the rotation direction of the Servomotor.	 5.4 Motor Direction Setting on page 5-15
Confirm that no abnormal vibration, noise, or temperature rise occurs. If any abnormalities are found, implement corrections.	 15.4 Troubleshooting Based on the Operation and Conditions of the Servomotor on page 15-73

Note: If the load machine is not sufficiently broken in before trial operation, the Servomotor may become overloaded.

7.5

Trial Operation with the Servomotor Connected to the Machine

This section provides the procedure for trial operation with both the machine and Servomotor.

7.5.1

Precautions

**WARNING**

- Operating mistakes that occur after the Servomotor is connected to the machine may not only damage the machine, but they may also cause accidents resulting in personal injury.



Important

If you disabled the overtravel function for trial operation of the Servomotor without a load, enable the overtravel function (P-OT and N-OT signal) before you preform trial operation with the Servomotor connected to the machine in order to provide protection.

If you will use a holding brake, observe the following precautions during trial operation.

- Before you check the operation of the brake, implement measures to prevent the machine from falling due to gravity and to prevent vibration from being caused by an external force.
- First check the Servomotor operation and brake operation with the Servomotor uncoupled from the machine. If no problems are found, connect the Servomotor to the machine and perform trial operation again.

Control the operation of the brake with the /BK (Brake) signal output from the SERVOPACK.

Refer to the following sections for information on wiring and the related parameter settings.

 [4.4.4 Wiring the SERVOPACK to the Holding Brake](#) on page 4-35

 [5.11 Holding Brake](#) on page 5-31



Important

Failures caused by incorrect wiring or incorrect voltage application in the brake circuit may cause the SERVOPACK to fail, damage the SERVOPACK, damage the equipment, or cause an accident resulting in death or injury.

Observe the precautions and instructions for wiring and trial operation precisely as described in this manual.





7.5.2

Preparations

Always confirm the following before you perform the trial operation procedure for both the machine and Servomotor.

- Make sure that the procedure described in [7.4 Trial Operation with Digital I/O and Serial Communications](#) on page 7-9 has been completed.
- Make sure that the SERVOPACK is connected correctly to both the host controller and the peripheral devices.
 - Safety Function Wiring
 - If you are not using the safety function, leave the Safety Jumper Connector (provided as an accessory with the SERVOPACK) connected to CN8.
 - If you are using the safety function, remove the Safety Jumper Connector from CN8 and connect the safety function device.
 - Overtravel wiring
 - Brake wiring
 - Allocation of the /BK (Brake) signal to a pin on the I/O signal connector (CN1)
 - Emergency stop circuit wiring
 - Host controller wiring

7.5.3 Operating Procedure

1. Enable the overtravel signals.
 5.10.2 *Overtravel Settings* on page 5-28
2. Make the settings for the protective functions, such as the safety function, overtravel, and the brake.
 4.7 *Connecting Safety Function Signals* on page 4-48
 5.10 *Overtravel and Related Settings* on page 5-27
 5.11 *Holding Brake* on page 5-31

3. Turn OFF the power supplies to the SERVOPACK.
 The control power supply and main circuit power supply will turn OFF.

4. Couple the Servomotor to the machine.

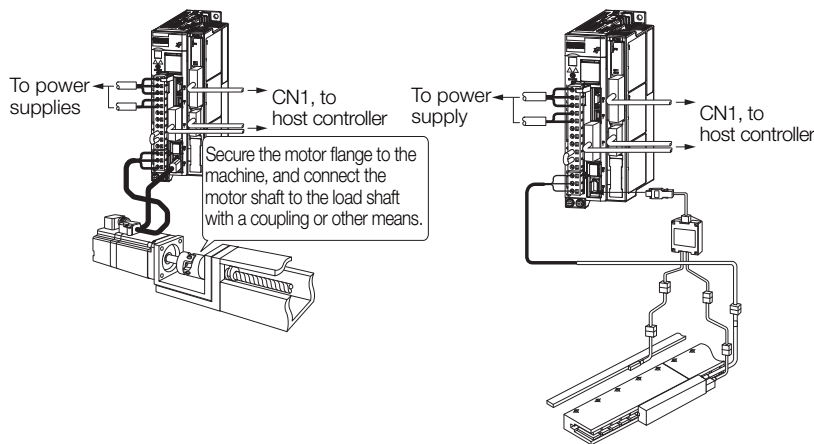

5. Turn ON the power supplies to the machine and host controller and turn ON the control power supply and main circuit power supply to the SERVOPACK.
6. Check the protective functions, such as overtravel and the brake, to confirm that they operate correctly.
 Note: Enable activating an emergency stop so that the Servomotor can be stopped safely should an error occur during the remainder of the procedure.
7. Perform trial operation according to 7.4 *Trial Operation with Digital I/O and Serial Communications* on page 7-9 and confirm that the same results are obtained as when trial operation was performed on the Servomotor without a load.
8. If necessary, adjust the servo gain to improve the Servomotor response characteristics. The Servomotor and machine may not be broken in completely for the trial operation. Therefore, let the system run for a sufficient amount of time to ensure that it is properly broken in.
9. For future maintenance, save the parameter settings with one of the following methods.
 - Use the SigmaWin+ to save the parameters as a file.
 - Use the Parameter Copy Mode of the Digital Operator.
 - Record the settings manually.

This concludes the procedure for trial operation with both the machine and Servomotor.

7.6

Convenient Function to Use during Trial Operation

This section describes some convenient operations that you can use during trial operation. Use them as required.

7.6.1 Program Jog Operation

You can use program jog operation to perform continuous operation with a preset operation pattern, travel distance, movement speed, acceleration/deceleration time, waiting time, and number of movements.

You can use this operation when you set up the system in the same way as for normal jog operation to move the Servomotor without connecting it to the host controller in order to check Servomotor operation and execute simple positioning.

Preparations

Always check the following before you execute program jog operation.

- The parameters must not be write prohibited.
- The main circuit power supply must be ON.
- There must be no alarms.
- There must be no hard wire base block (HWBB).
- The servo must be OFF.
- The range of machine motion and the safe movement speed of your machine must be considered when you set the travel distance and movement speed.
- There must be no overtravel.

Additional Information

- You can use the functions that are applicable position control. However, parameters related to Command Option Modules in PnB00 and higher are disabled.
- The overtravel function is enabled.

Program Jog Operation Pattern

An example of a program jog operation pattern is given below. In this example, the Servomotor direction is set to Pn000 = n.□□□0 (Use CCW as the forward direction).

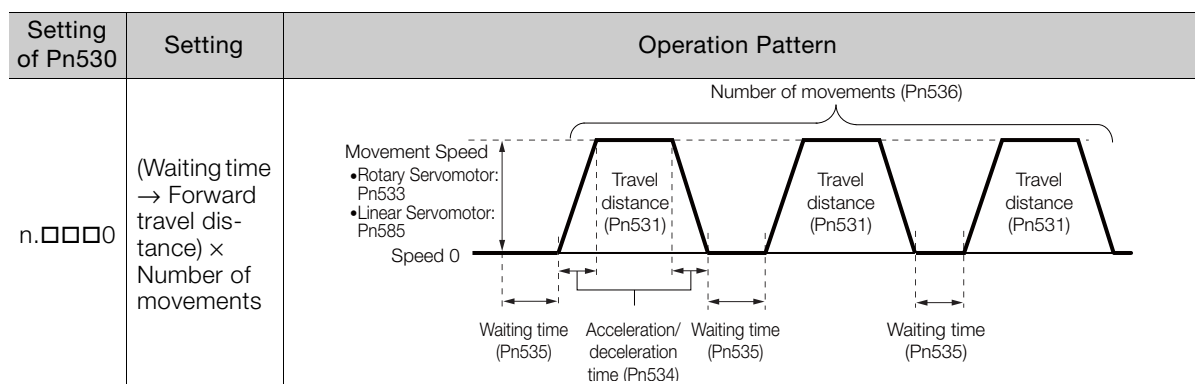

Continued on next page.

7.6 Convenient Function to Use during Trial Operation

7.6.1 Program Jog Operation

Continued from previous page.

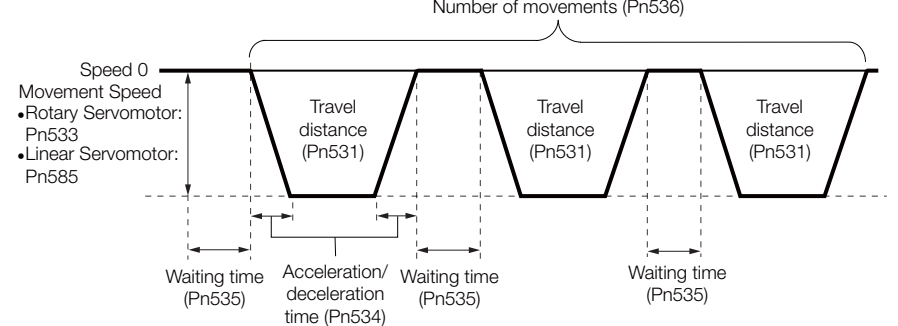
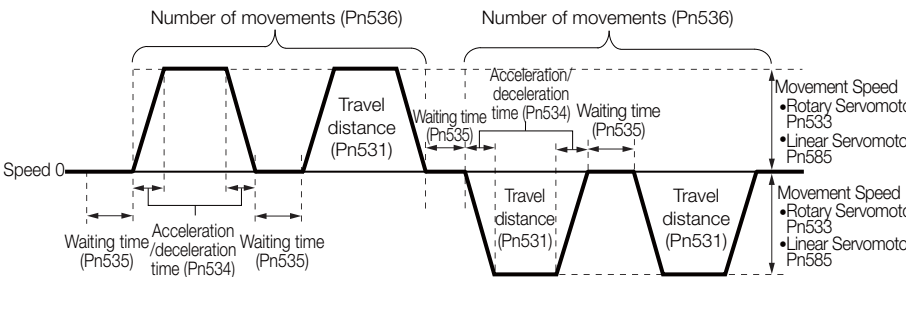
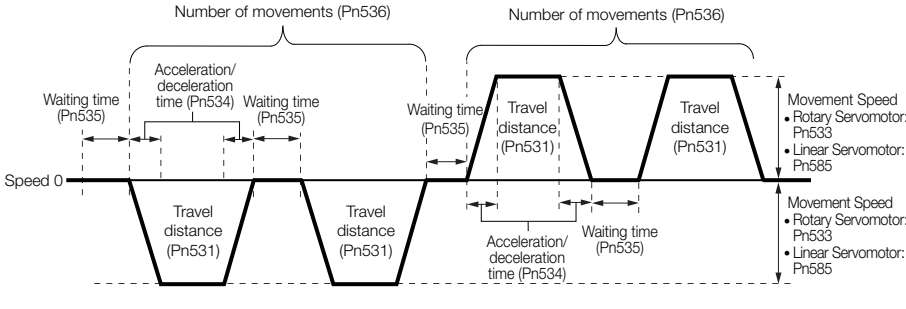
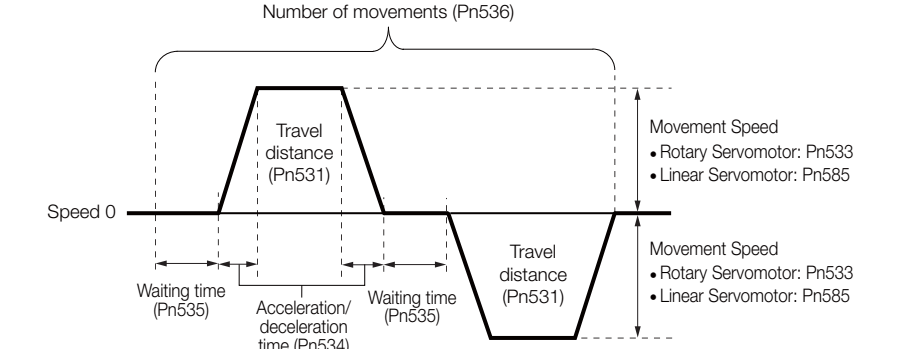
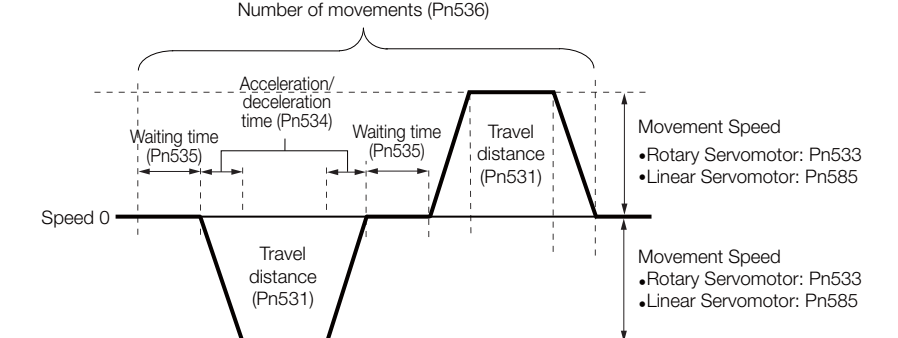
Setting of Pn530	Setting	Operation Pattern
n.□□□1	(Waiting time → Reverse by travel distance) × Number of movements	
n.□□□2	(Waiting time → Forward by travel distance) × Number of movements → (Waiting time → Reverse by travel distance) × Number of movements	
n.□□□3	(Waiting time → Reverse by travel distance) × Number of movements → (Waiting time → Forward by travel distance) × Number of movements	
n.□□□4	(Waiting time → Forward by travel distance) → (Waiting time → Reverse by travel distance) × Number of movements	
n.□□□5	(Waiting time → Reverse by travel distance) → (Waiting time → Forward by travel distance) × Number of movements	

Information

If Pn530 is set to n.□□□0, n.□□□1, n.□□□4, or n.□□□5, you can set Pn536 (Program Jog Operation Number of Movements) to 0 to perform infinite time operation. You cannot use infinite time operation if Pn530 is set to n.□□□2 or n.□□□3. If you perform infinite time operation from the Digital Operator, press the **JOG/SVON** Key to turn OFF the servo to end infinite time operation.

Related Parameters

Use the following parameters to set the program jog operation pattern. Do not change the settings while the program jog operation is being executed.

- Rotary Servomotors

Pn530	Program Jog Operation-Related Selections				
	Setting Range	Setting Unit	Default Setting	When Enabled	Classification
	0000 to 0005	–	0000	Immediately	Setup
Pn531	Program Jog Operation Travel Distance				
	Setting Range	Setting Unit	Default Setting	When Enabled	Classification
	1 to 1,073,741,824	1 reference unit	32,768	Immediately	Setup
Pn533	Program Jog Operation Movement Speed				
	Setting Range	Setting Unit	Default Setting	When Enabled	Classification
	1 to 10,000	1 min ⁻¹	500	Immediately	Setup
Pn534	Program Jog Operation Acceleration/Deceleration Time				
	Setting Range	Setting Unit	Default Setting	When Enabled	Classification
	2 to 10,000	1 ms	100	Immediately	Setup
Pn535	Program Jog Operation Waiting Time				
	Setting Range	Setting Unit	Default Setting	When Enabled	Classification
	0 to 10,000	1 ms	100	Immediately	Setup
Pn536	Program Jog Operation Number of Movements				
	Setting Range	Setting Unit	Default Setting	When Enabled	Classification
	0 to 1,000	1	1	Immediately	Setup

- Direct Drive Servomotors



Pn530	Program Jog Operation-Related Selections				
	Setting Range	Setting Unit	Default Setting	When Enabled	Classification
	0000 to 0005	–	0000	Immediately	Setup
Pn531	Program Jog Operation Travel Distance				
	Setting Range	Setting Unit	Default Setting	When Enabled	Classification
	1 to 1,073,741,824	1 reference unit	32,768	Immediately	Setup
Pn533	Program Jog Operation Movement Speed				
	Setting Range	Setting Unit	Default Setting	When Enabled	Classification
	1 to 10,000	0.1 min ⁻¹	500	Immediately	Setup
Pn534	Program Jog Operation Acceleration/Deceleration Time				
	Setting Range	Setting Unit	Default Setting	When Enabled	Classification
	2 to 10,000	1 ms	100	Immediately	Setup
Pn535	Program Jog Operation Waiting Time				
	Setting Range	Setting Unit	Default Setting	When Enabled	Classification
	0 to 10,000	1 ms	100	Immediately	Setup
Pn536	Program Jog Operation Number of Movements				
	Setting Range	Setting Unit	Default Setting	When Enabled	Classification
	0 to 1,000	1	1	Immediately	Setup

- Linear Servomotors

Pn530	Program Jog Operation-Related Selections				
	Setting Range	Setting Unit	Default Setting	When Enabled	Classification
	0000 to 0005	–	0000	Immediately	Setup
Pn531	Program Jog Operation Travel Distance				
	Setting Range	Setting Unit	Default Setting	When Enabled	Classification
	1 to 1,073,741,824	1 reference unit	32,768	Immediately	Setup
Pn585	Program Jog Operation Movement Speed				
	Setting Range	Setting Unit	Default Setting	When Enabled	Classification
	1 to 10,000	1 mm/s	50	Immediately	Setup
Pn534	Program Jog Operation Acceleration/Deceleration Time				
	Setting Range	Setting Unit	Default Setting	When Enabled	Classification
	2 to 10,000	1 ms	100	Immediately	Setup
Pn535	Program Jog Operation Waiting Time				
	Setting Range	Setting Unit	Default Setting	When Enabled	Classification
	0 to 10,000	1 ms	100	Immediately	Setup
Pn536	Program Jog Operation Number of Movements				
	Setting Range	Setting Unit	Default Setting	When Enabled	Classification
	0 to 1,000	1	1	Immediately	Setup

Applicable Tools

The following table lists the tools that you can use to perform program jog operation.

Tool	Fn No./Function Name	Reference
Digital Operator	Fn004	 Σ -7-Series Digital Operator Operating Manual (Manual No.: SIEP S800001 33)
SigmaWin+	Operation – Program JOG Operation	 <i>Operating Procedure</i> on page 7-16

Operating Procedure

Use the following procedure for a program jog operation.

1. Click the  Servo Drive Button in the workspace of the Main Window of the SigmaWin+.
2. Select **JOG Program** in the Menu Dialog Box.
The Jog Program Dialog Box will be displayed.

3. Read the warnings and then click the OK Button.

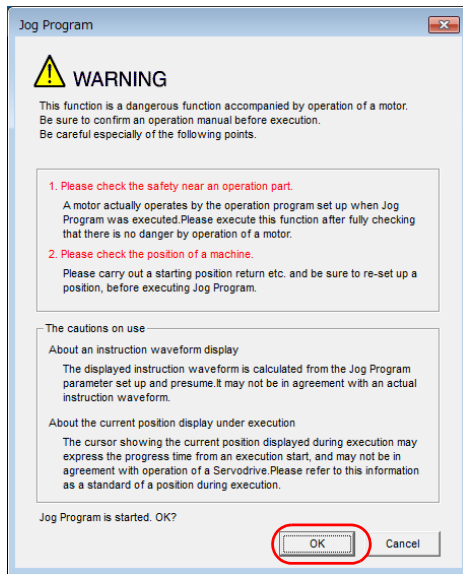

4. Set the operating conditions, click the Apply Button, and then click the Run Button.
A graph of the operation pattern will be displayed.

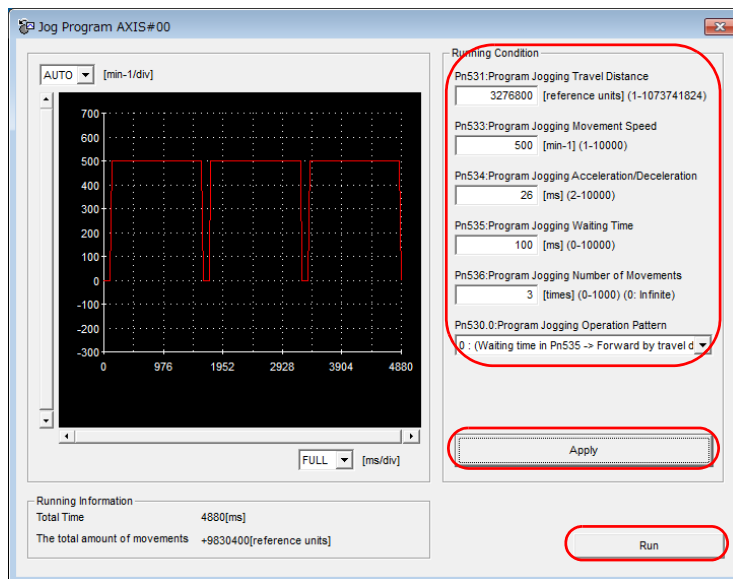

- Click the **Servo ON** Button and then the **Execute** Button. The program jog operation will be executed.

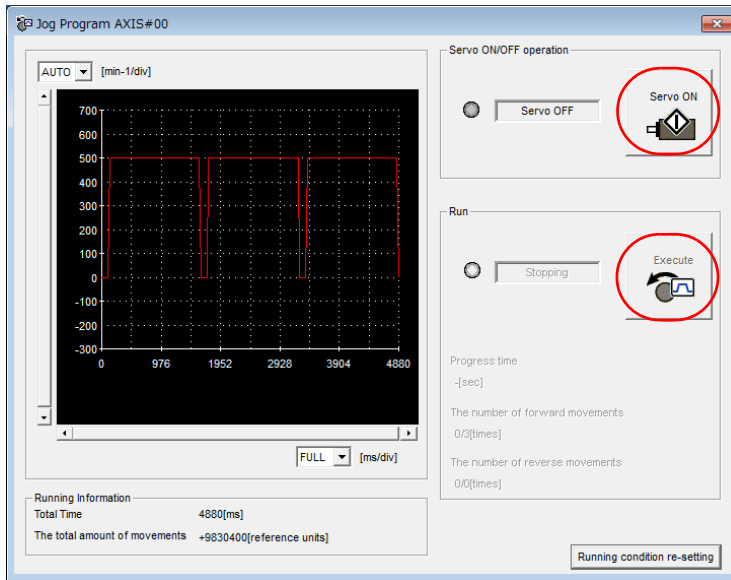

⚠ CAUTION

- Be aware of the following points if you cancel the program jog operation while the Servomotor is operating.
 - If you cancel operation with the **Servo OFF** Button, the Servomotor will stop according to setting of the Servo OFF stopping method (Pn001 = n.□□□X).
 - If you cancel operation with the **Cancel** Button, the Servomotor will decelerate to a stop and then enter a zero-clamped state.

This concludes the program jog operation procedure.

7.6.2 Origin Search

The origin search operation positions the motor to phase C of the encoder and then clamps it there.

Even when using fully-closed loop control the motor is positioned to phase C of the encoder, and not to the external encoder origin.

The overtravel function is disabled during an origin search.

CAUTION

- Make sure that the load is not coupled when you execute an origin search. Since the P-OT (Forward Drive Prohibit Input) signal and N-OT (Reverse Drive Prohibit Input) signal are disabled during an origin search, the machine may be damaged by exceeding its movement limits.

Use an origin search when it is necessary to align encoder phase C of the servomotor with the machine origin. The following speeds are used for origin searches.

- Rotary Servomotors: 60 min⁻¹
- Direct Drive Servomotors: 6 min⁻¹
- Linear Servomotors: 15 mm/s

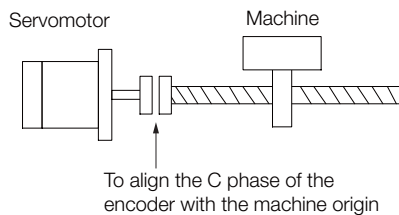

Preparations

Always check the following before you execute an origin search.

- The parameters must not be write prohibited.
- The main circuit power supply must be ON.
- There must be no alarms.
- There must be no hard wire base block (HWBB).
- The servo must be OFF.

Applicable Tools

The following table lists the tools that you can use to perform an origin search.

Tool	Fn No./Function Name	Reference
Digital Operator	Fn003	Σ-7-Series Digital Operator Operating Manual (Manual No.: SIEP S800001 33)
SigmaWin+*	Encoder Setting – Search Origin	Operating Procedure on page 7-20

* Cannot be used when connecting a Linear Servomotor.

Operating Procedure

Use the following procedure to perform an origin search.

1. Click the  Servo Drive Button in the workspace of the Main Window of the SigmaWin+.
2. Select **Search Origin** in the Menu Dialog Box.
The Origin Search Dialog Box will be displayed.
3. Read the warnings and then click the **OK** Button.

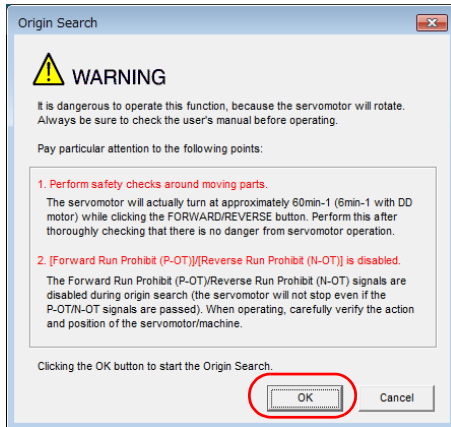

4. Click the **Servo ON** Button.

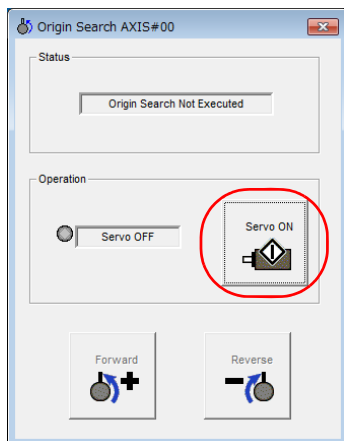

5. Click the **Forward** Button or the **Reverse** Button.

An origin search will be performed only while you hold down the mouse button. The motor will stop when the origin search has been completed.

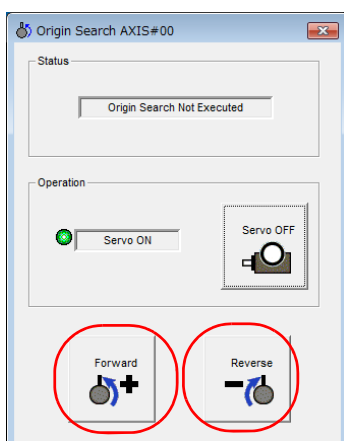

This concludes the origin search procedure.

7.6.3 Test without a Motor

A test without a motor is used to check the operation of the host controller and peripheral devices by simulating the operation of the Servomotor in the SERVOPACK, i.e., without actually operating a Servomotor. This test allows you to check wiring, debug the system, and verify parameters to shorten the time required for setup work and to prevent damage to the machine that may result from possible malfunctions. The operation of the Servomotor can be checked with this test regardless of whether the Servomotor is actually connected or not.

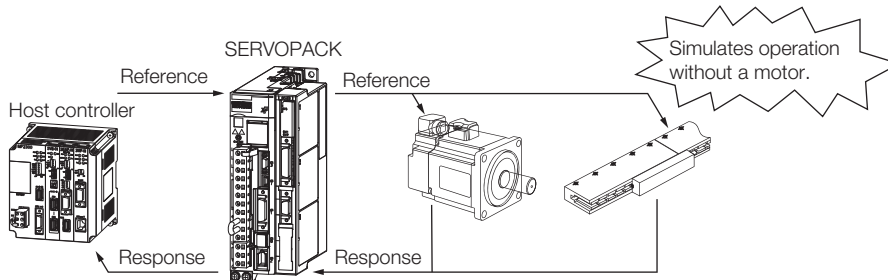

Use Pn00C = n.□□□X to enable or disable the test without a motor.

Parameter	Meaning	When Enabled	Classification	
Pn00C	n.□□□0 (default setting)	Disable tests without a motor.	After restart	Setup
	n.□□□1	Enable tests without a motor.		

Information An asterisk is displayed on the status display of the Digital Operator while a test without a motor is being executed.

Motor Information and Encoder Information

The motor and encoder information is used during tests without a motor. The source of the information depends on the device connection status.

• Rotary Servomotor

Motor Connection Status	Information That Is Used	Source of Information
Connected	Motor information • Rated motor speed • Maximum motor speed	Information in the Servomotor that is connected
	Encoder information • Encoder resolution • Encoder type	
Not connected	Motor information • Rated motor speed • Maximum motor speed	<ul style="list-style-type: none"> Setting of Pn000 = n.X□□□ (Rotary/Linear Startup Selection When Encoder Is Not Connected) Rated motor speed and maximum motor speed The values previously saved in the SERVOPACK will be used for the rated motor speed and maximum motor speed. Use the motor displays (Un020: Rated Motor Speed and Un021: Maximum Motor Speed:) to check the values.
	Encoder information • Encoder resolution • Encoder type	<ul style="list-style-type: none"> Encoder resolution: Setting of Pn00C = n.□□X□ (Encoder Resolution for Tests without a Motor) Encoder type: Setting of Pn00C = n.□X□□ (Encoder Type Selection for Tests without a Motor)

If you use fully-closed loop control, the external encoder information is also used.

7.6 Convenient Function to Use during Trial Operation

7.6.3 Test without a Motor

External Encoder Connection Status	Information That Is Used	Source of Information
Connected	External encoder information	Information in the external encoder that is connected
Not connected	<ul style="list-style-type: none"> Resolution Encoder type 	<ul style="list-style-type: none"> Resolution: 256 Encoder type: Incremental encoder

• Linear Servomotors

Motor Connection Status	Information That Is Used	Source of Information
Connected	Motor information	Information in the motor that is connected
	Linear encoder information <ul style="list-style-type: none"> Resolution Encoder pitch Encoder type 	Information in the linear encoder that is connected
Not connected	Motor information	Setting of Pn000 = n.X□□□ (Rotary/Linear Startup Selection When Encoder Is Not Connected)
	Linear encoder information <ul style="list-style-type: none"> Resolution Encoder pitch Encoder type 	<ul style="list-style-type: none"> Resolution: 256 Encoder pitch: Setting of Pn282 (Linear Encoder Pitch) Encoder type: Setting of Pn00C = n.□X□□ (Encoder Type Selection for Tests without a Motor)

• Related Parameters

Parameter		Meaning	When Enabled	Classification
Pn000	n.0□□□ (default setting)	When an encoder is not connected, start as SERVOPACK for Rotary Servomotor.	After restart	Setup
	n.1□□□	When an encoder is not connected, start as SERVOPACK for Linear Servomotor.		

Pn282	Linear Encoder Pitch				
	Setting Range	Setting Unit	Default Setting	When Enabled	Classification
	0 to 6,553,600	0.01 μm	0	After restart	Setup

Parameter		Meaning	When Enabled	Classification
Pn00C	n.□□0□ (default setting)	Use 13 bits as encoder resolution for tests without a motor.	After restart	Setup
	n.□□1□	Use 20 bits as encoder resolution for tests without a motor.		
	n.□□2□	Use 22 bits as encoder resolution for tests without a motor.		
	n.□□3□	Use 24 bits as encoder resolution for tests without a motor.		
	n.□0□□ (default setting)	Use an incremental encoder for tests without a motor.		
	n.□1□□	Use an absolute encoder for tests without a motor.		

Motor Position and Speed Responses

For a test without a motor, the following responses are simulated for references from the host controller according to the gain settings for position or speed control.

- Servomotor position
- Motor speed
- External encoder position

The load model will be for a rigid system with the moment of inertia ratio that is set in Pn103.

Restrictions

The following functions cannot be used during the test without a motor.

- Regeneration and dynamic brake operation
- Brake output signal
- Items marked with “x” in the following utility function table

Button in Menu Dialog Box	SigmaWin+	Digital Operator		Executable?		Reference
	SigmaWin+ Function Name	Fn No.	Utility Function Name	Motor Not Connected	Motor Connected	
Basic Functions	Initialize* ¹	FnB0B	Initialize INDEXER Parameter Settings	○	○	page 5-10
	Software Reset	Fn030	Software Reset	○	○	page 6-30
	Product Information	Fn011	Display Servomotor Model	○	○	page 9-2
		Fn012	Display Software Version	○	○	
		Fn01E	Display SERVOPACK and Servomotor IDs	○	○	
Fn01F	Display Servomotor ID from Feedback Option Module	○	○			
Encoder Setting	Absolute Encoder Reset	Fn008	Reset Absolute Encoder	×	○	page 5-48
	Multi-turn Limit Setup	Fn013	Multiturn Limit Setting after Multiturn Limit Disagreement Alarm	×	○	page 6-26
	Search Origin* ²	Fn003	Origin Search	○	○	page 7-19
	Zero Point Position Setting	Fn020	Set Absolute Linear Encoder Origin	×	○	page 5-51
	Polarity Detection	Fn080	Polarity Detection	×	×	page 5-26
	–	FnB09	Set Absolute Encoder Origin	○	○	page 12-6
Table Editing	Edit Program Table	FnB03	Edit/Save Program Table	○	○	page 13-14
		FnB06	Initialize Program Table	○	○	
	Edit ZONE Table	FnB04	Edit/Save ZONE Table	○	○	page 13-55
		FnB07	Initialize ZONE Table	○	○	
	Edit Jog Speed Table	FnB05	Edit/Save Jog Speed Table	○	○	page 13-46
		FnB08	Initialize Jog Speed Table	○	○	
Trouble-shooting	Display Alarm	FnB0D	Display INDEXER Alarm History	○	○	page 15-51
		FnB0C	Reset INDEXER Alarm History	○	○	page 15-52
			Reset INDEXER Alarm	○	○	page 15-49
	Fn014	Reset Option Module Configuration Error	○	○	page 15-53	
	Reset Motor Type Alarm	Fn021	Reset Motor Type Alarm	○	○	page 15-55
Operation	Jog	Fn002	Jog	○	○	page 7-6
	Program JOG Operation	Fn004	Jog Program	○	○	page 7-13
Monitor	Monitor	FnB0A	INDEXER Status Monitor	○	○	page 9-3

Continued on next page.

7.6 Convenient Function to Use during Trial Operation

7.6.3 Test without a Motor

Continued from previous page.

SigmaWin+		Digital Operator		Executable?		Reference
Button in Menu Dialog Box	SigmaWin+ Function Name	Fn No.	Utility Function Name	Motor Not Connected	Motor Connected	
Tuning	Tuning - Autotuning without Host Reference	Fn201	Advanced Autotuning without Reference	×	×	page 8-23
	Tuning - Autotuning with Host Reference	Fn202	Advanced Autotuning with Reference	×	×	page 8-34
	Tuning - Custom Tuning	Fn203	One-Parameter Tuning	×	×	page 8-41
	Tuning - Custom Tuning - Adjust Anti-resonance Control	Fn204	Adjust Anti-resonance Control	×	×	page 8-49
	Tuning - Custom Tuning - Vibration Suppression	Fn205	Vibration Suppression	×	×	page 8-54
	Response Level Setting	Fn200	Tuning-less Level Setting	×	×	page 8-11
Diagnostic	Easy FFT	Fn206	Easy FFT	×	×	page 8-89
Others	Adjust the Analog Monitor Output	Fn00C	Adjust Analog Monitor Output Offset	○	○	page 9-10
		Fn00D	Adjust Analog Monitor Output Gain	○	○	
	Adjust the Motor Current Detection Offsets	Fn00E	Autotune Motor Current Detection Signal Offset	×	○	page 6-36
		Fn00F	Manually Adjust Motor Current Detection Signal Offset	×	○	
	Initialize Vibration Detection Level	Fn01B	Initialize Vibration Detection Level	×	×	page 6-32
	Write Prohibited Setting	Fn010	Write Prohibition Setting	○	○	page 5-6

*1. An **Initialize** Button will be displayed in the Parameter Editing Dialog Box.

*2. Cannot be used when connecting a Linear Servomotor.

Tuning

8

This chapter provides information on the flow of tuning, details on tuning functions, and related operating procedures.

8.1	Overview and Flow of Tuning	8-4
8.1.1	Tuning Functions	8-5
8.1.2	Diagnostic Tool	8-5
8.2	Monitoring Methods	8-6
8.3	Precautions to Ensure Safe Tuning	8-7
8.3.1	Overtravel Settings	8-7
8.3.2	Torque Limit Settings	8-7
8.3.3	Setting the Position Deviation Overflow Alarm Level	8-7
8.3.4	Vibration Detection Level Setting	8-9
8.3.5	Setting the Position Deviation Overflow Alarm Level at Servo ON	8-9
8.4	Tuning-less Function	8-11
8.4.1	Application Restrictions	8-11
8.4.2	Operating Procedure	8-12
8.4.3	Troubleshooting Alarms	8-13
8.4.4	Parameters Disabled by Tuning-less Function	8-14
8.4.5	Automatically Adjusted Function Setting	8-14
8.4.6	Related Parameters	8-14
8.5	Estimating the Moment of Inertia	8-15
8.5.1	Outline	8-15
8.5.2	Restrictions	8-16
8.5.3	Applicable Tools	8-16
8.5.4	Operating Procedure	8-17

8.6 Autotuning without Host Reference8-23

8.6.1 Outline8-23
8.6.2 Restrictions8-24
8.6.3 Applicable Tools8-25
8.6.4 Operating Procedure8-25
8.6.5 Troubleshooting Problems in Autotuning
without a Host Reference8-29
8.6.6 Automatically Adjusted Function Settings8-31
8.6.7 Related Parameters8-33

8.7 Autotuning with a Host Reference8-34

8.7.1 Outline8-34
8.7.2 Restrictions8-35
8.7.3 Applicable Tools8-35
8.7.4 Operating Procedure8-36
8.7.5 Troubleshooting Problems in Autotuning
with a Host Reference8-39
8.7.6 Automatically Adjusted Function Settings8-39
8.7.7 Related Parameters8-40

8.8 Custom Tuning8-41

8.8.1 Outline8-41
8.8.2 Preparations8-41
8.8.3 Applicable Tools8-42
8.8.4 Operating Procedure8-42
8.8.5 Automatically Adjusted Function Settings8-47
8.8.6 Tuning Example for Tuning Mode 2 or 38-47
8.8.7 Related Parameters8-48

8.9 Anti-Resonance Control Adjustment8-49

8.9.1 Outline8-49
8.9.2 Preparations8-49
8.9.3 Applicable Tools8-50
8.9.4 Operating Procedure8-50
8.9.5 Related Parameters8-52
8.9.6 Suppressing Different Vibration Frequencies
with Anti-resonance Control8-52

8.10 Vibration Suppression8-54

8.10.1 Outline8-54
8.10.2 Preparations8-55
8.10.3 Applicable Tools8-55
8.10.4 Operating Procedure8-55
8.10.5 Related Parameters8-57

8.11 Speed Ripple Compensation8-58

8.11.1 Outline8-58
8.11.2 Setting Up Speed Ripple Compensation8-58
8.11.3 Setting Parameters8-62

8.12 Additional Adjustment Functions 8-64

- 8.12.1 Automatic Gain Switching 8-64
- 8.12.2 Friction Compensation 8-67
- 8.12.3 Gravity Compensation 8-69
- 8.12.4 Current Control Mode Selection 8-70
- 8.12.5 Current Gain Level Setting 8-70
- 8.12.6 Speed Detection Method Selection 8-71
- 8.12.7 Speed Feedback Filter 8-71
- 8.12.8 Backlash Compensation 8-71

8.13 Manual Tuning 8-73

- 8.13.1 Tuning the Servo Gains 8-73
- 8.13.2 Compatible Adjustment Functions 8-84

8.14 Diagnostic Tools 8-88

- 8.14.1 Mechanical Analysis 8-88
- 8.14.2 Easy FFT 8-89

8.1 Overview and Flow of Tuning

Tuning is performed to optimize response by adjusting the servo gains in the SERVOPACK.

The servo gains are set using a combination of parameters, such as parameters for the speed loop gain, position loop gain, filters, friction compensation, and moment of inertia ratio. These parameters influence each other, so you must consider the balance between them.

The servo gains are set to stable settings by default. Use the various tuning functions to increase the response even further for the conditions of your machine.

The basic tuning procedure is shown in the following flowchart. Make suitable adjustments considering the conditions and operating requirements of your machine.

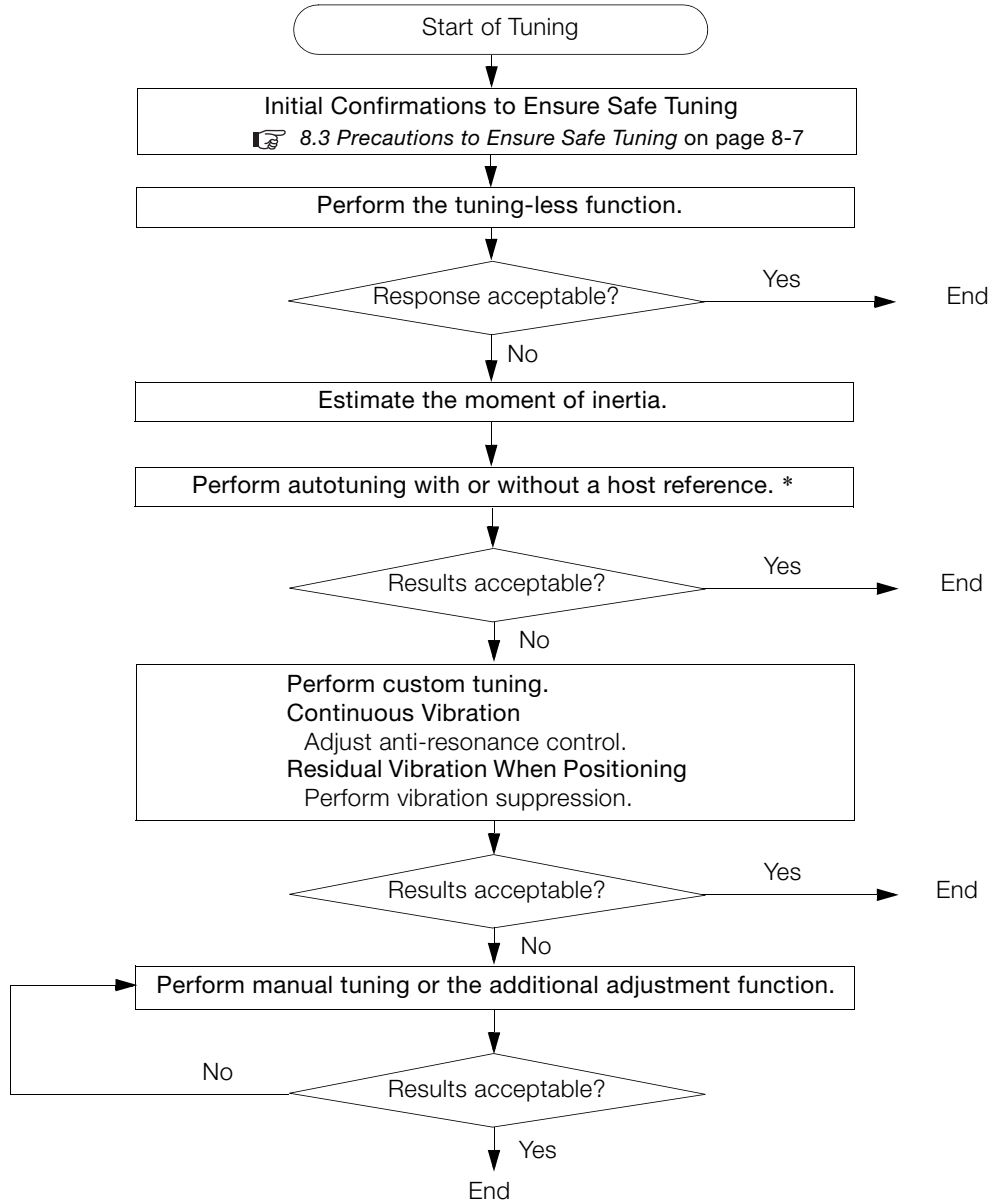

* If possible, perform autotuning with a host reference.
 If a host controller is not available, set an operation pattern that is as close as possible to the host reference and perform autotuning without a host reference.
 If an operation pattern that is close to the host reference is not possible, perform autotuning with a host reference while performing program jogging.

8.1.1 Tuning Functions

The following table provides an overview of the tuning functions.

Tuning Function	Outline	Reference
Tuning-less Function	This automatic adjustment function is designed to enable stable operation without servo tuning. This function can be used to obtain a stable response regardless of the type of machine or changes in the load. You can use it with the default settings.	page 8-11
Moment of Inertia Estimation	The moment of inertia ratio is calculated by operating the Servomotor a few times. The moment of inertia ratio that is calculated here is used in other tuning functions.	page 8-15
Autotuning without Host Reference	The following parameters are automatically adjusted in the internal references in the SERVOPACK during automatic operation. <ul style="list-style-type: none"> • Gains (e.g., position loop gain and speed loop gain) • Filters (torque reference filter and notch filters) • Friction compensation • Anti-resonance control • Vibration suppression 	page 8-23
Autotuning with Host Reference	The following parameters are automatically adjusted with the position reference input from the host controller while the machine is in operation. You can use this function for fine-tuning after you perform autotuning without a host reference. <ul style="list-style-type: none"> • Gains (e.g., position loop gain and speed loop gain) • Filters (torque reference filter and notch filters) • Friction compensation • Anti-resonance control • Vibration suppression 	page 8-34
Custom Tuning	The following parameters are adjusted with the position reference or speed reference input from the host controller while the machine is in operation. <ul style="list-style-type: none"> • Gains (e.g., position loop gain and speed loop gain) • Filters (torque reference filter and notch filters) • Friction compensation • Anti-resonance control 	page 8-41
Anti-resonance Control Adjustment	This function effectively suppresses continuous vibration.	page 8-49
Vibration Suppression	This function effectively suppresses residual vibration if it occurs when positioning.	page 8-54
Speed Ripple Compensation	This function reduces the ripple in the motor speed.	page 8-58
Additional Adjustment Function	This function combines autotuning with custom tuning. You can use it to improve adjustment results.	page 8-64
Manual Tuning	You can manually adjust the servo gains to adjust the response.	page 8-73

8.1.2 Diagnostic Tool

You can use the following tools to measure the frequency characteristics of the machine and set notch filters.

Diagnostic Tool	Outline	Reference
Mechanical Analysis	The machine is subjected to vibration to detect resonance frequencies. The measurement results are displayed as waveforms or numeric data.	page 8-88
Easy FFT	The machine is subjected to vibration to detect resonance frequencies. The measurement results are displayed only as numeric data.	page 8-89

8.2 Monitoring Methods

You can use the data tracing function of the SigmaWin+ or the analog monitor signals of the SERVOPACK for monitoring. If you perform custom tuning or manual tuning, always use the above functions to monitor the machine operating status and SERVOPACK signal waveform while you adjust the servo gains.

Check the adjustment results with the following response waveforms.

Item	Unit	
	Rotary Servomotor	Linear Servomotor
Torque reference	%	
Feedback speed	min ⁻¹	mm/s
Position reference speed	min ⁻¹	mm/s
Position deviation	Reference units	

8.3

Precautions to Ensure Safe Tuning

 **CAUTION**

- Observe the following precautions when you perform tuning.
 - Do not touch the rotating parts of the motor when the servo is ON.
 - Before starting the Servomotor, make sure that an emergency stop can be performed at any time.
 - Make sure that trial operation has been successfully performed without any problems.
 - Provide an appropriate stopping device on the machine to ensure safety.

Perform the following settings in a way that is suitable for tuning.

8.3.1 Overtravel Settings

Overtravel settings are made to force the Servomotor to stop for a signal input from a limit switch when a moving part of the machine exceeds the safe movement range.

Refer to the following section for details.

 5.10 *Overtravel and Related Settings* on page 5-27

8.3.2 Torque Limit Settings

You can limit the torque that is output by the Servomotor based on calculations of the torque required for machine operation. You can use torque limits to reduce the amount of shock applied to the machine when problems occur, such as collisions or interference. If the torque limit is lower than the torque that is required for operation, overshooting or vibration may occur.

Refer to the following section for details.

 6.6 *Internal Torque Limits* on page 6-22

8.3.3 Setting the Position Deviation Overflow Alarm Level

The position deviation overflow alarm is a protective function that is enabled when the SERVOPACK is used in position control.

If the alarm level is set to a suitable value, the SERVOPACK will detect excessive position deviation and will stop the Servomotor if the Servomotor operation does not agree with the reference.

The position deviation is the difference between the position reference value and the actual position.

You can calculate the position deviation from the position loop gain (Pn102) and the motor speed with the following formula.

- **Rotary Servomotors**

$$\text{Position deviation [reference units]} = \frac{\text{Motor speed [min}^{-1}\text{]}}{60} \times \frac{\text{Encoder resolution}^{*1}}{\text{Pn102 [0.1/s/10}^{*2, *3}} \times \frac{\text{Pn210}}{\text{Pn20E}}$$

- **Linear Servomotors**

$$\text{Position deviation [reference units]} = \frac{\text{Motor speed [mm/s]}}{\text{Pn102 [0.1/s/10}^{*2, *3}} \times \frac{\text{Resolution}}{\text{Linear encoder pitch [\mu m]/1,000}} \times \frac{\text{Pn210}}{\text{Pn20E}}$$

8.3.3 Setting the Position Deviation Overflow Alarm Level

Position Deviation Overflow Alarm Level (Pn520) [setting unit: reference units]

• Rotary Servomotors

$$Pn520 > \frac{\text{Maximum motor speed [min}^{-1}\text{]}}{60} \times \frac{\text{Encoder resolution}^{*1}}{Pn102 [0.1/s/10^{*2}, *3]} \times \frac{Pn210}{Pn20E} \times \underline{\underline{(1.2 \text{ to } 2)^{*4}}}$$

• Linear Servomotors

$$Pn520 > \frac{\text{Maximum motor speed [mm/s]}}{Pn102 [0.1/s/10^{*2}, *3]} \times \frac{\text{Resolution}}{\text{Linear encoder pitch [\mu m]/1,000}} \times \frac{Pn210}{Pn20E} \times \underline{\underline{(1.2 \text{ to } 2)^{*4}}}$$

*1. Refer to the following section for details.

 5.14 Electronic Gear Settings on page 5-41

*2. When model following control (Pn140 = n.□□□1) is enabled, use the setting of Pn141 (Model Following Control Gain) instead of the setting of Pn102 (Position Loop Gain).

*3. To check the setting of Pn102 on the Digital Operator, change the parameter display setting to display all parameters (Pn00B = n.□□□1).

*4. The underlined coefficient “x (1.2 to 2)” adds a margin to prevent an A.d00 alarm (Position Deviation Overflow) from occurring too frequently.

If you set a value that satisfies the formula, an A.d00 alarm (Position Deviation Overflow) should not occur during normal operation.

If the Servomotor operation does not agree with the reference, position deviation will occur, an error will be detected, and the Servomotor will stop.

The following calculation example uses a Rotary Servomotor with a maximum motor speed of

6,000 and an encoder resolution of 16,777,216 (24 bits). Pn102 is set to 400. $\frac{Pn210}{Pn20E} = \frac{1}{1}$

$$\begin{aligned} Pn520 &= \frac{6,000}{60} \times \frac{16,777,216}{400/10} \times \frac{1}{16} \times 2 \\ &= 2,621,440 \times 2 \\ &= 5,242,880 \text{ (default setting of Pn520)} \end{aligned}$$

If the acceleration/deceleration rate required for the position reference exceeds the tracking capacity of the Servomotor, the tracking delay will increase and the position deviation will no longer satisfy the above formulas. If this occurs, lower the acceleration/deceleration rate so that the Servomotor can follow the position reference or increase the position deviation overflow alarm level.

Related Parameters

Pn520	Position Deviation Overflow Alarm Level				
	Setting Range	Setting Unit	Default Setting	When Enabled	Classification
	1 to 1,073,741,823	1 reference unit	5,242,880	Immediately	Setup
Pn51E	Position Deviation Overflow Warning Level				
	Setting Range	Setting Unit	Default Setting	When Enabled	Classification
	10 to 100	1%	100	Immediately	Setup

Related Alarm

Alarm Number	Alarm Name	Alarm Meaning
A.d00	Position Deviation Overflow	This alarm occurs if the position deviation exceeds the setting of Pn520 (Position Deviation Overflow Alarm Level).

Related Warning

Warning Number	Warning Name	Warning Meaning
A.900	Position Deviation Overflow	This warning occurs if the position deviation exceeds the specified percentage (Pn520 × Pn51E/100).

8.3.4 Vibration Detection Level Setting

You can set the vibration detection level (Pn312) to more accurately detect A.520 alarms (Vibration Alarm) and A.911 warnings (Vibration Warning) when vibration is detected during machine operation.

Set the initial vibration detection level to an appropriate value. Refer to the following section for details.

 6.10 Initializing the Vibration Detection Level on page 6-32

8.3.5 Setting the Position Deviation Overflow Alarm Level at Servo ON

If the servo is turned ON when there is a large position deviation, the Servomotor will attempt to return to the original position to bring the position deviation to 0, which may create a hazardous situation. To prevent this, you can set a position deviation overflow alarm level at servo ON to restrict operation.

The related parameters and alarms are given in the following tables.

Related Parameters

Position Deviation Overflow Alarm Level at Servo ON					
Pn526	Setting Range	Setting Unit	Default Setting	When Enabled	Classification
	1 to 1,073,741,823	1 reference unit	5,242,880	Immediately	Setup
Position Deviation Overflow Warning Level at Servo ON					
Pn528	Setting Range	Setting Unit	Default Setting	When Enabled	Classification
	10 to 100	1%	100	Immediately	Setup

• Rotary Servomotors

Speed Limit Level at Servo ON					
Pn529	Setting Range	Setting Unit	Default Setting	When Enabled	Classification
	0 to 10,000	1 min ⁻¹	10,000	Immediately	Setup

• Linear Servomotors

Speed Limit Level at Servo ON					
Pn584	Setting Range	Setting Unit	Default Setting	When Enabled	Classification
	0 to 10,000	1 mm/s	10,000	Immediately	Setup

Related Alarms

Alarm Number	Alarm Name	Alarm Meaning
A.d01	Position Deviation Overflow Alarm at Servo ON	This alarm occurs if the servo is turned ON after the position deviation exceeded the setting of Pn526 (Excessive Position Deviation Alarm Level at Servo ON) while the servo was OFF.
A.d02	Position Deviation Overflow Alarm for Speed Limit at Servo ON	If position deviation remains in the deviation counter, the setting of Pn529 or Pn584 (Speed Limit Level at Servo ON) will limit the speed when the servo is turned ON. This alarm occurs if a position reference is input and the setting of Pn520 (Excessive Position Deviation Alarm Level) is exceeded.

Refer to the following section for information on troubleshooting alarms.

 15.2.4 Resetting INDEXER Alarms on page 15-49

Related Warning

Warning Number	Warning Name	Warning Meaning
A.901	Position Deviation Overflow Warning at Servo ON	This warning occurs if the servo is turned ON while the position deviation exceeds the specified percentage (Pn526 × Pn528/100).

8.4 Tuning-less Function

The tuning-less function performs autotuning to obtain a stable response regardless of the type of machine or changes in the load. Autotuning is started when the servo is turned ON.

CAUTION

- The Servomotor may momentarily emit a sound or vibrate the first time the servo is turned ON after the Servomotor is connected to the machine. This sound is caused by setting the automatic notch filter. It does not indicate a problem. However, if this sound or vibration continues, manually set a function to suppress vibration (e.g., a notch filter).
- The Servomotor may vibrate if it exceeds the allowable load moment of inertia. If that occurs, set the tuning-less load level to 2 (Pn170 = n.2□□□) or reduce the Tuning-less Rigidity Level (Pn170 = n.□X□□).
- To ensure safety, make sure that you can perform an emergency stop at any time when you execute the tuning-less function.

8.4.1 Application Restrictions

The following application restrictions apply to the tuning-less function.

Function	Executable?	Remarks
Vibration Detection Level Initialization	○	–
Moment of Inertia Estimation	×	Disable the tuning-less function (Pn170 = n.□□□0) before you execute moment of inertia estimation.
Autotuning without Host Reference	×	Disable the tuning-less function (Pn170 = n.□□□0) before you execute autotuning without a host reference.
Autotuning with Host Reference	×	–
Custom Tuning	×	–
Anti-Resonance Control Adjustment	×	–
Vibration Suppression	×	–
Easy FFT	○	The tuning-less function is disabled while you execute Easy FFT and then it is enabled when Easy FFT has been completed.
Friction Compensation	×	–
Gain Selection	×	–
Mechanical Analysis	○	The tuning-less function is disabled while you execute mechanical analysis and then it is enabled when mechanical analysis has been completed.

* ○: Yes ×: No

8.4.2 Operating Procedure

The tuning-less function is enabled in the default settings. No specific procedure is required. You can use the following parameter to enable or disable the tuning-less function.

Parameter		Meaning	When Enabled	Classification
Pn170	n.□□□0	Disable tuning-less function.	After restart	Setup
	n.□□□1 (default setting)	Enable tuning-less function.		
	n.□□0□ (default setting)	Use for speed control.		
	n.□□1□	Use for speed control and use host controller for position control.		

When you enable the tuning-less function, you can select the tuning-less type. Normally, set Pn14F to n.□□2□ (Use tuning-less type 3) (default setting). If compatibility with previous models is required, set Pn14F to n.□□0□ (Use tuning-less type 1) or n.□□1□ (Use tuning-less type 2).

Parameter		Meaning	When Enabled	Classification
Pn14F	n.□□0□	Use tuning-less type 1.	After restart	Tuning
	n.□□1□	Use tuning-less type 2. (The noise level is improved more than with tuning-less type 1.)		
	n.□□2□ (default setting)	Use tuning-less type 3.		

Tuning-less Level Settings

If vibration or other problems occur, change the tuning-less levels. To change the tuning-less levels, use the SigmaWin+.

◆ Preparations

Always check the following before you set the tuning-less levels.

- The tuning-less function must be enabled (Pn170 = n.□□□1).
- The test without a motor function must be disabled (Pn00C = n.□□□0).

◆ Procedure

Use the following procedure to set the tuning-less levels.

In addition to the following procedure, you can also set the parameters directly. Refer to *Related Parameters*, below, for the parameters to set.

1. Click the  Servo Drive Button in the workspace of the Main Window of the SigmaWin+.
2. Select **Response Level Setting** in the Menu Dialog Box.
The Tuning-less Level Setting-Adj Dialog Box will be displayed.

- Click the ▲ or ▼ Button to adjust the tuning-less level setting. Increase the tuning-less level setting to increase the response. Decrease the tuning-less level setting to suppress vibration.

The default response level setting is 4.

Tuning-less Level	Description	Remarks
7	Response level: High	You cannot select these levels if tuning-less type 1 or 2 (Pn14F = n.□□0□ or n.□□1□) is used.
6		
5		
4 (default setting)		
3		
2		
1		
0	Response level: Low	-

- Click the **Completed** Button.
The adjustment results will be saved in the SERVOPACK.

◆ Related Parameters

■ Tuning-less Rigidity Level

If you use tuning-less type 1 or 2 (Pn14F = n.□□0□ or n.□□1□), set the tuning-less level to between 0 and 4 (Pn170 = n.□0□□ to n.□4□□). Do not set the tuning-less level to between 5 and 7 (Pn170 = n.□5□□ to n.□7□□).

Parameter	Description	When Enabled	Classification
Pn170	n.□0□□	Immediately	Setup
	n.□1□□		
	n.□2□□		
	n.□3□□		
	n.□4□□ (default setting)		
	n.□5□□		
	n.□6□□		
n.□7□□	Tuning-less rigidity level 7 (high rigidity)		

■ Tuning-less Load Level

Parameter	Description	When Enabled	Classification
Pn170	n.0□□□	Immediately	Setup
	n.1□□□ (default setting)		
	n.2□□□		

8.4.3 Troubleshooting Alarms

An A.521 alarm (Autotuning Alarm) will occur if a resonant sound occurs or if excessive vibration occurs during position control. If an alarm occurs, implement the following measures.

- Resonant Sound
Decrease the setting of Pn170 = n.X□□□ or the setting of Pn170 = n.□X□□.
- Excessive Vibration during Position Control
Increase the setting of Pn170 = n.X□□□ or decrease the setting of Pn170 = n.□X□□.

8.4.4 Parameters Disabled by Tuning-less Function

When the tuning-less function is enabled (Pn170 = n.□□□1) (default setting), the parameters in the following table are disabled.

Item	Parameter Name	Parameter Number
Gain-Related Parameters	Speed Loop Gain	Pn100
	Second Speed Loop Gain	Pn104
	Speed Loop Integral Time Constant	Pn101
	Second Speed Loop Integral Time Constant	Pn105
	Position Loop Gain	Pn102
	Second Position Loop Gain	Pn106
	Moment of Inertia Ratio	Pn103
Advanced Control-Related Parameters	Friction Compensation Function Selection	Pn408 = n.X□□□
	Anti-Resonance Control Selection	Pn160 = n.□□□X
Gain Selection-Related Parameters	Gain Switching Selection	Pn139 = n.□□□X

The tuning-less function is disabled during Easy FFT and mechanical analysis for a vertical axis. The gain-related parameters in the above table are enabled for Easy FFT and mechanical analysis for a vertical axis.

8.4.5 Automatically Adjusted Function Setting

You can also automatically adjust notch filters.

Normally, set Pn460 to n.□1□□ (Adjust automatically) (default setting). Vibration is automatically detected and a notch filter is set.

Set Pn460 to n.□0□□ (Do not adjust automatically) only if you do not change the setting of the notch filter before you execute the tuning-less function.

Parameter	Meaning	When Enabled	Classification
Pn460	n.□0□□	Immediately	Tuning
	n.□1□□ (default setting)		

8.4.6 Related Parameters

The following parameters are automatically adjusted when you execute the tuning-less function.

Do not manually change the settings of these parameters after you have enabled the tuning-less function.

Parameter	Name
Pn401	First Stage First Torque Reference Filter Time Constant
Pn40A	First Stage Notch Filter Q Value
Pn40C	Second Stage Notch Filter Frequency
Pn40D	Second Stage Notch Filter Q Value

8.5 Estimating the Moment of Inertia

This section describes how the moment of inertia is calculated.

The moment of inertia ratio that is calculated here is used in other tuning functions. You can also estimate the moment of inertia during autotuning without a host reference. Refer to the following section for the procedure.

 8.6.4 Operating Procedure on page 8-25

8.5.1 Outline

The moment of inertia during operation is automatically calculated by the SERVOPACK for round-trip (forward and reverse) operation. A reference from the host controller is not used.

The moment of inertia ratio (i.e., the ratio of the load moment of inertia to the motor moment of inertia) is a basic parameter for adjusting gains. It must be set as accurately as possible.

Although the load moment of inertia can be calculated from the weight and structure of the mechanisms, doing so is very troublesome and calculating it accurately can be very difficult with the complex mechanical structures that are used these days. With an estimate of the moment of inertia, you can obtain an accurate load moment of inertia simply by running the Servomotor in the actual system in a forward and reverse direction a few times.

The Servomotor is operated with the following specifications.

- Maximum speed: $\pm 1,000 \text{ min}^{-1}$ (can be changed)
- Acceleration rate: $\pm 20,000 \text{ min}^{-1}/\text{s}$ (can be changed)
- Travel distance: ± 2.5 rotations max. (can be changed)

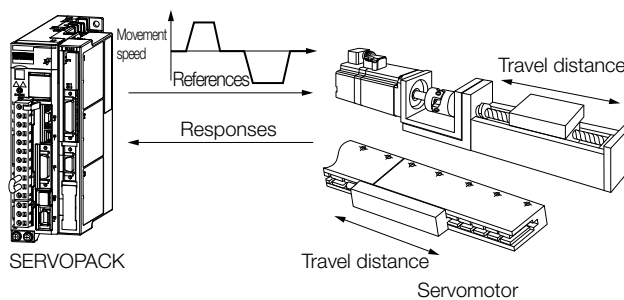

Note: Execute moment of inertia estimation after jog operation to a position that ensures a suitable range

8.5.2 Restrictions

The following restrictions apply to estimating the moment of inertia.

Systems for which Execution Cannot Be Performed

- When the machine system can move only in one direction
- When the range of motion is 0.5 rotations or less

Systems for Which Adjustments Cannot Be Made Accurately

- When a suitable range of motion is not possible
- When the moment of inertia changes within the set operating range
- When the machine has high dynamic friction
- When the rigidity of the machine is low and vibration occurs when positioning is performed
- When the position integration function is used
- When mode switching is used

Note: If you specify moment of inertia estimation, mode switching will be disabled and PI control will be used while the moment of inertia is being calculated. Mode switching will be enabled after moment of inertia estimation has been completed.

Preparations

Always check the following before you execute moment of inertia estimation.

- The main circuit power supply must be ON.
- There must be no overtravel.
- The servo must be OFF.
- The gain switching selection must be set to disable automatic gain switching (Pn139 = n.□□□0).
- The first gains must be selected.
- The test without a motor function must be disabled (Pn00C = n.□□□0).
- There must be no alarms or warnings.
- There must be no hard wire base block (HWBB).
- The parameters must not be write prohibited.
- The tuning-less function must be disabled (Pn170 = n.□□□0).

8.5.3 Applicable Tools

The following table lists the tools that you can use to estimate the moment of inertia.

Tool	Fn No./Function Name	Operating Procedure Reference
Digital Operator	You cannot estimate the moment of inertia from the Digital Operator.	
SigmaWin+	Tuning - Tuning	 8.5.4 Operating Procedure on page 8-17

8.5.4 Operating Procedure

Use the following procedure to estimate the moment of inertia ratio.

WARNING

- Estimating the moment of inertia requires operating the Servomotor and therefore presents hazards. Observe the following precautions.
 - Confirm safety around moving parts.
This function involves automatic operation with vibration. Make sure that you can perform an emergency stop (to turn OFF the power supply) at any time. There will be movement in both directions within the set range of movement. Check the range of movement and the directions and implement protective controls for safety, such as the overtravel functions.

CAUTION

- Be aware of the following points if you cancel the moment of inertia estimation while the Servomotor is operating.
 - If you cancel operation with the **Servo OFF** Button, the Servomotor will stop according to setting of the Servo OFF stopping method (Pn001 = n.□□□X).
 - If you cancel operation with the **Cancel** Button, the Servomotor will decelerate to a stop and then enter a zero-clamped state.

1. Click the  Servo Drive Button in the workspace of the Main Window of the SigmaWin+.
2. Select **Tuning** in the Menu Dialog Box.
The Tuning Dialog Box will be displayed.
Click the **Cancel** Button to cancel tuning.
3. Click the **Execute** Button.

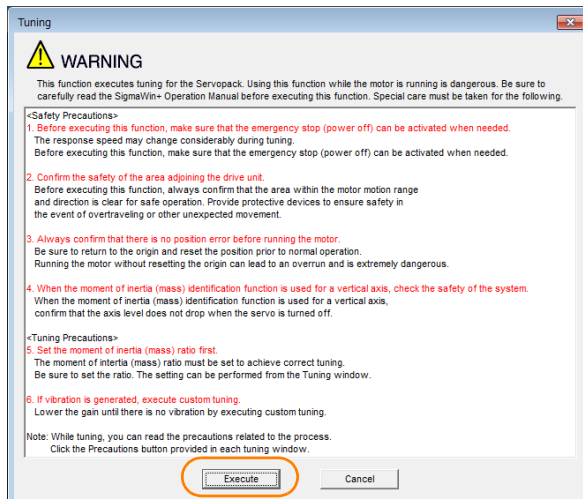

4. Click the **Execute** Button.

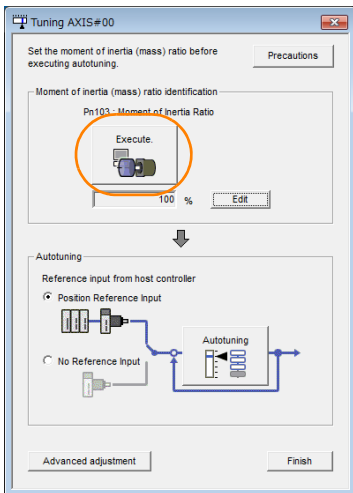

5. Set the conditions as required.

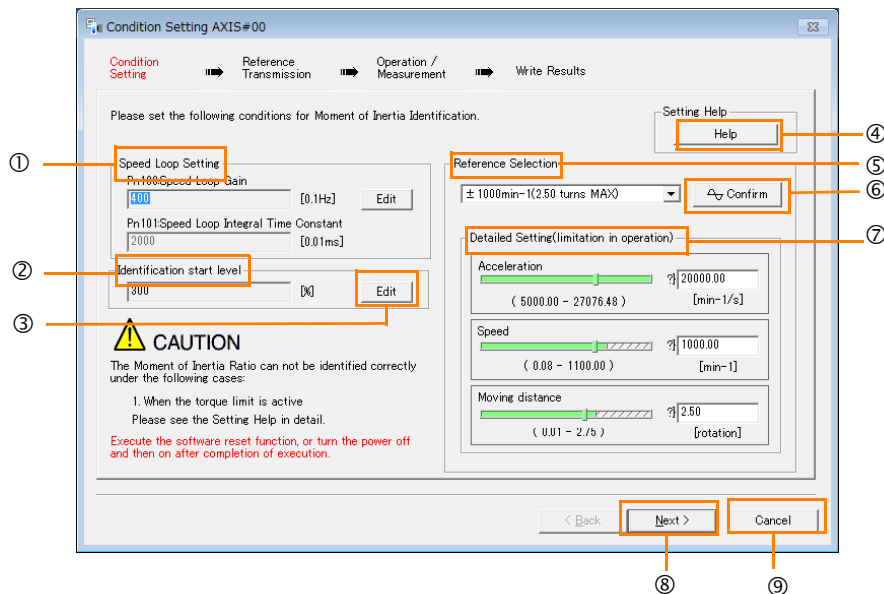

- ① **Speed Loop Setting Area**
 Make the speed loop settings in this area.
 If the speed loop response is too bad, it will not be possible to measure the moment of inertia ratio accurately.
 The values for the speed loop response that are required for moment of inertia estimation are set for the default settings. It is normally not necessary to change these settings.
 If the default speed loop gain is too high for the machine (i.e., if vibration occurs), lower the setting. It is not necessary to increase the setting any farther.
- ② **Identification Start Level Group**
 This is the setting of the moment of inertia calculation starting level.
 If the load is large or the machine has low rigidity, the torque limit may be applied, causing moment of inertia estimation to fail.
 If that occurs, estimation may be possible if you double the setting of the start level.
- ③ **Edit Buttons**
 Click the button to display a dialog box to change the settings related to the speed loop or estimation start level.

④ **Help** Button

Click this button to display guidelines for setting the reference conditions. Make the following settings as required.

- Operate the Servomotor to measure the load moment of inertia of the machine in comparison with the rotor moment of inertia.
- Set the operation mode, reference pattern (maximum acceleration rate, maximum speed, and maximum travel distance), and speed loop-related parameters.
- Correct measurement of the moment of inertia ratio may not be possible depending on the settings. Set suitable settings using the measurement results as reference.

⑤ **Reference Selection** Area

Either select the reference pattern for estimation processing from the box, or set the values in the **Detailed Setting** Group. Generally speaking, the larger the maximum acceleration rate is, the more accurate the moment of inertia estimation will be.

Set the maximum acceleration range within the possible range of movement considering the gear ratio, e.g., the pulley diameters or ball screw pitch.

⑥ **Confirm** Button

Click this button to display the Reference Confirmation Dialog Box.

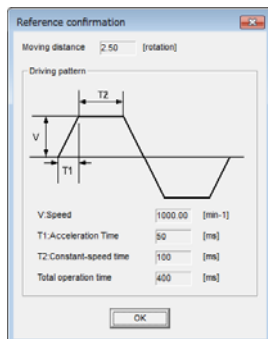
⑦ **Detailed Setting** Area

You can change the settings by moving the bars or directly inputting the settings to create the required reference pattern.

⑧ **Next** Button

Click this button to display the Reference Transmission Dialog Box.

⑨ **Cancel** Button

Click this button to return to the Tuning Dialog Box.

⚠ CAUTION

- The travel distance is the distance for one operation in the forward or reverse direction. During multiple operations, the operation starting position may move in one direction or the other. Confirm the possible operating range for each measurement or operation.
- Depending on the parameter settings and the moment of inertia of the machine, overshooting may occur and may cause the maximum speed setting to be exceeded temporarily. Allow sufficient leeway in the settings.

Information

When Measurement Is Not Correct

Estimating the moment of inertia ratio cannot be performed correctly if the torque limit is activated. Adjust the limits or reduce the acceleration rate in the reference selection so that the torque limit is not activated.

6. Click the Next Button.

The Reference Transmission Dialog Box will be displayed.

7. Click the **Start** Button.

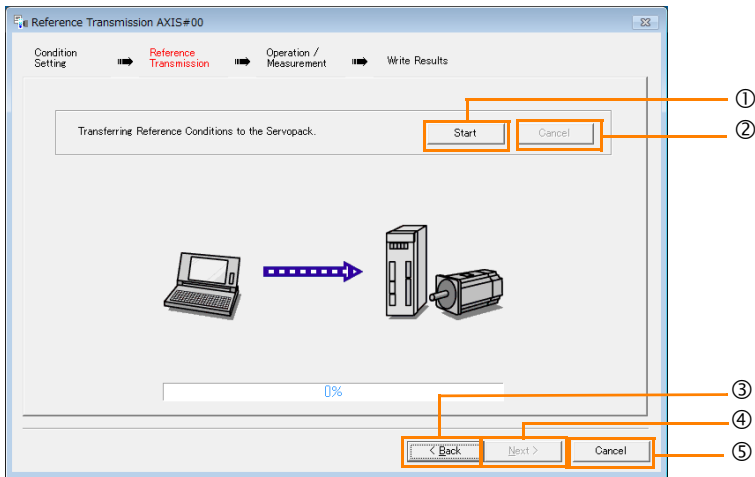

- ① **Start** Button
The reference conditions will be transferred to the SERVOPACK. A progress bar will show the progress of the transfer.
- ② **Cancel** Button
The **Cancel** Button is enabled only while data is being transferred to the SERVOPACK. You cannot use it after the transfer has been completed.
- ③ **Back** Button
This button returns you to the Condition Setting Dialog Box. It is disabled while data is being transferred.
- ④ **Next** Button
This button is enabled only when the data has been transferred correctly. You cannot use it if an error occurs or if you cancel the transfer before it is completed. Click the **Next** Button to display the Operation/Measurement Dialog Box.
- ⑤ **Cancel** Button
This button cancels processing and returns you to the Tuning Dialog Box.

8. Click the **Next** Button.

The Operation/Measurement Dialog Box will be displayed.

9. Click the **Servo On** Button.

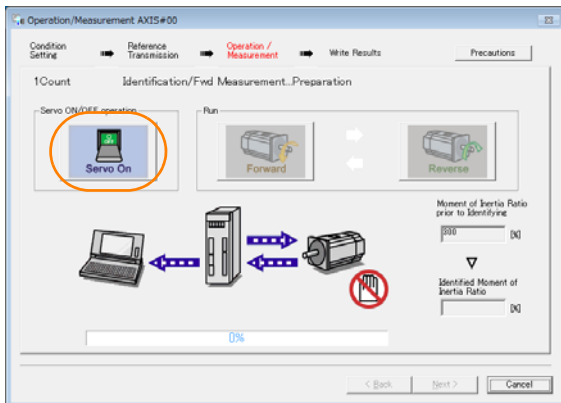

10. Click the **Forward** Button.

The Servomotor shaft will rotate in the forward direction and the measurement will start. After the measurement and data transfer have been completed, the **Reverse** Button will be displayed in color.

11. Click the Reverse Button.

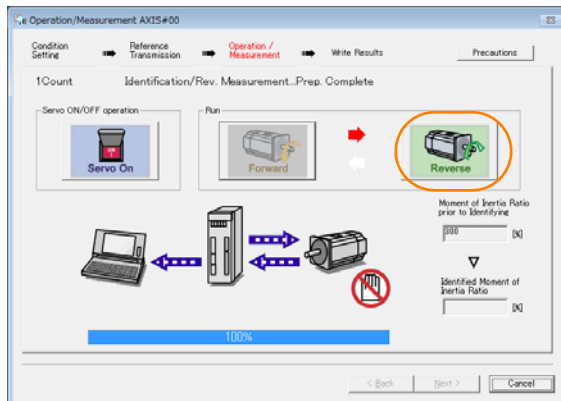

The Servomotor shaft will rotate in the reverse direction and the measurement will start. After the measurement and data transfer have been completed, the **Forward** Button will be displayed in color.

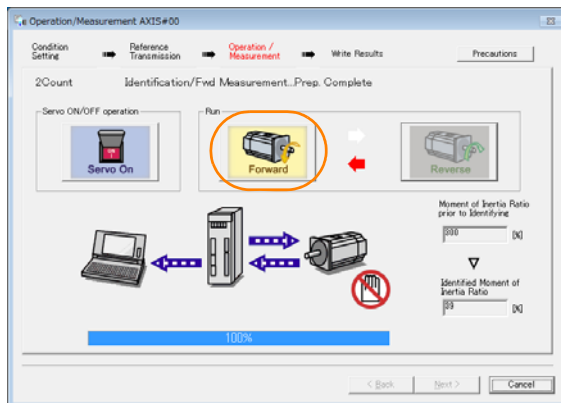

12. Repeat steps 9 to 11 until the **Next** Button is enabled.

Measurements are performed from 2 to 7 times and then verified. The number of measurements is displayed in upper left corner of the dialog box. A progress bar at the bottom of the dialog box will show the progress of the transfer each time.

13. When the measurements have been completed, click the **Servo On** Button to turn OFF the servo.

14. Click the **Next** Button.

The Write Results Dialog Box will be displayed.

Information If you click the **Next** Button before you turn OFF the servo, the following Dialog Box will be displayed. Click the **OK** Button to turn OFF the servo.

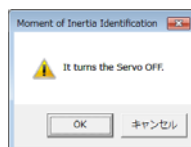

15. Click the **Writing Results** Button.

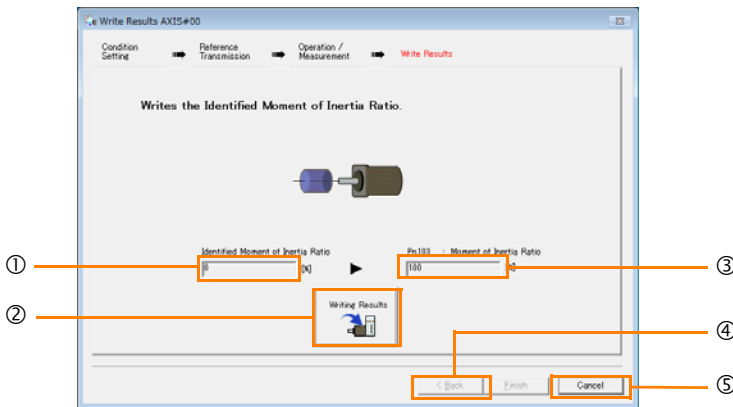

- ① **Identified Moment of Inertia Ratio** Box
The moment of inertia ratio that was found with operation and measurements is displayed here.
- ② **Writing Results** Button
If you click this button, Pn103 (Moment of Inertia Ratio) in the SERVOPACK is set to the value that is displayed for the identified moment of inertia ratio.
- ③ **Pn103: Moment of Inertia Ratio** Box
The value that is set for the parameter is displayed here.
After you click the **Writing Results** Button, the value that was found with operation and measurements will be displayed as the new setting.
- ④ **Back** Button
This button is disabled.
- ⑤ **Cancel** Button
This button will return you to the Tuning Dialog Box.

16. Confirm that the **Identified Moment of Inertia Ratio** Box and the **Pn103: Moment of Inertia Ratio** Box show the same value and then click the **Finish** Button.

17. Click the **OK** Button.

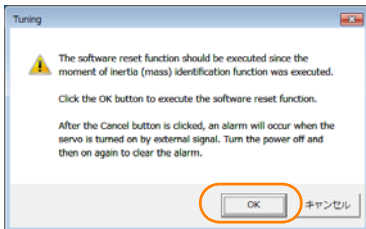

18. Click the **Execute** Button.

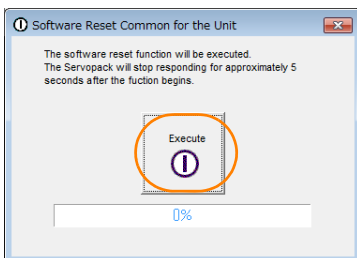

If the setting of the moment of inertia ratio (Pn103) was changed, the new value will be saved and the Tuning Dialog Box will be displayed again.

This concludes the procedure to estimate the moment of inertia ratio.

8.6

Autotuning without Host Reference

This section describes autotuning without a host reference.



Important

- Autotuning without a host reference performs adjustments based on the setting of the speed loop gain (Pn100). Therefore, precise adjustments cannot be made if there is vibration when adjustments are started. Make adjustments after lowering the speed loop gain (Pn100) until vibration is eliminated.
- You cannot execute autotuning without a host reference if the tuning-less function is enabled (Pn170 = n.□□□1 (default setting)). Disable the tuning-less function (Pn170 = n.□□□0) before you execute autotuning without a host reference.
- If you change the machine load conditions or drive system after you execute autotuning without a host reference and then you execute autotuning without a host reference with moment of inertia estimation specified, use the following parameter settings. If you execute autotuning without a host reference for any other conditions, the machine may vibrate and may be damaged.

Pn140 = n.□□□0 (Do not use model following control.)

Pn160 = n.□□□0 (Do not use anti-resonance control.)

Pn408 = n.00□0 (Disable friction compensation, first stage notch filter, and second stage notch filter.)

Note: If you are using the Digital Operator and the above parameters are not displayed, change the parameter display setting to display all parameters (Pn00B = n.□□□1) and then turn the power supply OFF and ON again.

8.6.1

Outline

For autotuning without a host reference, operation is automatically performed by the SERVO-PACK for round-trip (forward and reverse) operation to adjust for machine characteristics during operation. A reference from the host controller is not used.

The following items are adjusted automatically.

- Moment of inertia ratio
- Gains (e.g., speed loop gain and position loop gain)
- Filters (torque reference filter and notch filters)
- Friction compensation
- Anti-resonance control
- Vibration suppression (only for mode 2 or 3)

Refer to the following section for details on the parameters that are adjusted.

8.6.7 Related Parameters on page 8-33

The Servomotor is operated with the following specifications.

Maximum speed	Rated motor speed × $\frac{2}{3}$	
Acceleration Torque	Rated motor torque: Approx. 100% Note: The acceleration torque depends on the setting of the moment of inertia ratio (Pn103), and the influences of machine friction and external disturbance.	
Travel Distance	Rotary Servomotors	You can set the desired travel distance. The default setting is for a value equivalent to 3 Servomotor shaft rotations.
	Direct Drive Servomotors	You can set the desired travel distance. The default setting is for a value equivalent to 0.3 rotations.
	Linear Servomotors	You can set the desired travel distance in increments of 1,000 reference units. (The default setting is for 90 mm.)

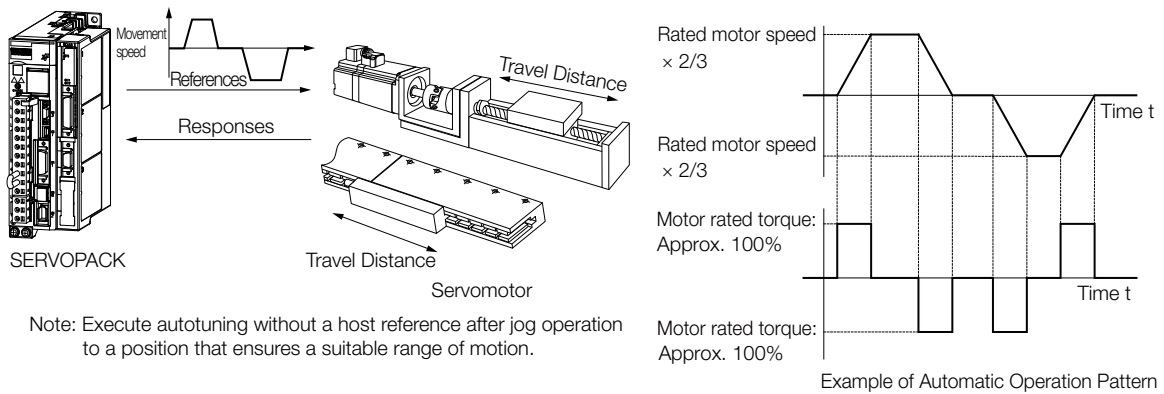

! WARNING

- Autotuning without a host reference requires operating the Servomotor and therefore presents hazards. Observe the following precaution.
 - Confirm safety around moving parts.
 - This function involves automatic operation with vibration. Make sure that you can perform an emergency stop (to turn OFF the power supply) at any time. There will be movement in both directions within the set range of movement. Check the range of movement and the directions and implement protective controls for safety, such as the overtravel functions.

8.6.2 Restrictions

The following restrictions apply to autotuning without a host reference.

If you cannot use autotuning without a host reference because of these restrictions, use autotuning with a host reference or custom tuning. Refer to the following sections for details.

8.7 Autotuning with a Host Reference on page 8-34

8.8 Custom Tuning on page 8-41

Systems for Which Execution Cannot Be Performed

- When the machine system can move only in one direction
- When the range of motion is 0.5 rotations or less

Systems for Which Adjustments Cannot Be Made Accurately

- When a suitable range of motion is not possible
- When the moment of inertia changes within the set operating range
- When the machine has high friction
- When the rigidity of the machine is low and vibration occurs when positioning is performed
- When the position integration function is used
- When mode switching is used

Note: If you specify moment of inertia estimation, mode switching will be disabled and PI control will be used while the moment of inertia is being calculated. Mode switching will be enabled after moment of inertia estimation has been completed.

- When the positioning completed width (Pn522) is too narrow

Preparations

Always check the following before you execute autotuning without a host reference.



- The main circuit power supply must be ON.
- There must be no overtravel.
- The servo must be OFF.
- The gain switching selection must be set to disable automatic gain switching (Pn139 = n.□□□0).
- The first gains must be selected.
- The test without a motor function must be disabled (Pn00C = n.□□□0).
- There must be no alarms or warnings.
- There must be no hard wire base block (HWBB).
- The parameters must not be write prohibited.
- The tuning-less function must be disabled (Pn170 = n.□□□0), or the tuning-less function must be enabled (Pn170 = n.□□□1) (default setting) and moment of inertia estimation must be specified.
- If you execute autotuning without a host reference during speed control, set the mode to 1.

Information

- If you start autotuning without a host reference while the SERVOPACK is in speed control for mode 2 or 3, the SERVOPACK will change to position control automatically to perform autotuning without a host reference. The SERVOPACK will return to speed control after autotuning has been completed.

8.6.3 Applicable Tools

The following table lists the tools that you can use to perform autotuning without a host reference.

Tool	Fn No./Function Name	Operating Procedure Reference
Digital Operator	Fn201	 Σ -7-Series Digital Operator Operating Manual (Manual No.: SIEP S800001 33)
SigmaWin+	<i>Tuning - Tuning</i>	 8.6.4 Operating Procedure on page 8-25

8.6.4 Operating Procedure

Use the following procedure to perform autotuning without a host reference.

CAUTION

- If you specify not estimating the moment of inertia, set the moment of inertia ratio (Pn103) correctly. If the setting greatly differs from the actual moment of inertia ratio, normal control of the machine may not be possible, and vibration may result.

1. Confirm that the moment of inertia ratio (Pn103) is set correctly.
2. Click the  Servo Drive Button in the workspace of the Main Window of the SigmaWin+.
3. Select **Tuning** in the Menu Dialog Box.
The Tuning Dialog Box will be displayed.
Click the **Cancel** Button to cancel tuning.

4. Click the **Execute** Button.

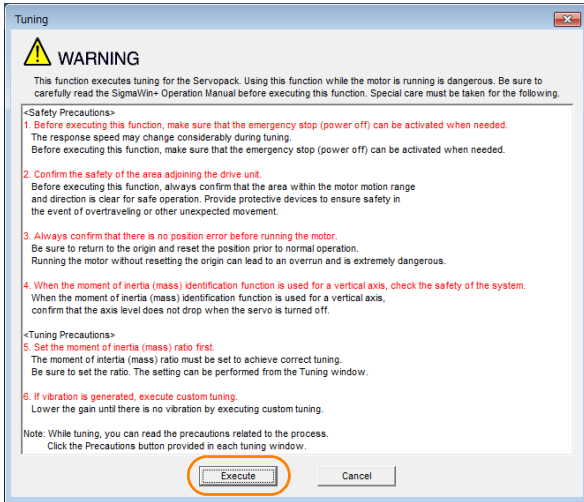

5. Select the **No Reference Input** Option in the Autotuning Area and then click the **Auto-tuning** Button.

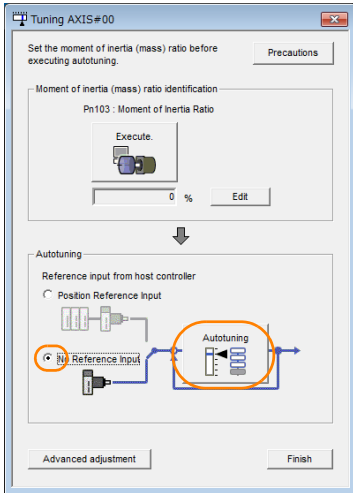

Information When the following dialog box is displayed, click the **OK** Button and then confirm that the correct moment of inertia ratio is set in Pn103 (Moment of Inertia Ratio).

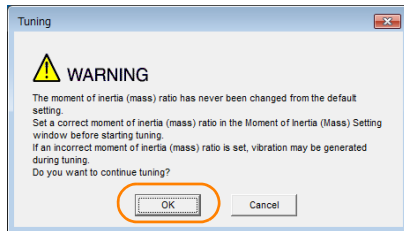

6. Set the conditions in the **Switching the load moment of inertia (load mass) identification** Box, the **Mode selection** Box, the **Mechanism selection** Box, and the **Distance** Box, and then click the **Next** Button.

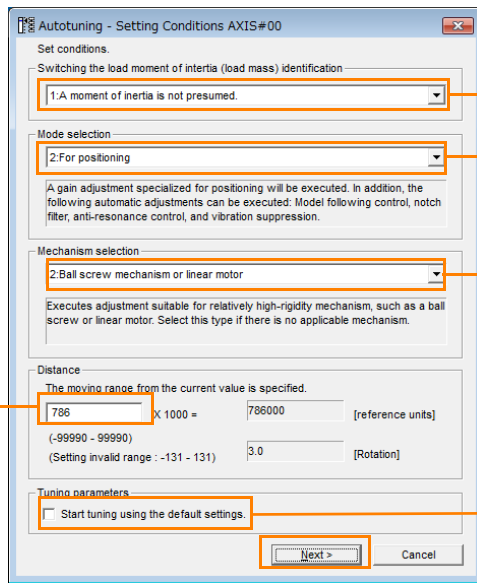

• **Switching the load moment of inertia (load mass) identification Box**

Specify whether to estimate the moment of inertia.
 0: A moment of inertia is presumed. (default setting)
 1: A moment of inertia is not presumed.

• **Mode selection Box**

Set the mode.

Mode Selection	Description
1: Standard	Standard gain adjustment is performed. In addition to gain adjustment, notch filters and anti-resonance control are automatically adjusted.
2: For positioning	Tuning is performed for positioning applications. In addition to gain adjustment, model following control, notch filters, anti-resonance control, and vibration suppression are automatically adjusted.
3: For positioning especially to prevent overshooting	Tuning is performed for positioning applications with emphasis on eliminating overshooting. In addition to gain adjustment, notch filters, anti-resonance control, and vibration suppression are automatically adjusted.

• **Distance Box**

Set the travel distance.
 Movement range: -99,990,000 to +99,990,000 [reference units]
 Minimum setting increment for travel distance: 1,000 [reference units]
 Negative values are for reverse operation and positive values are for forward operation from the current position.
 Default settings:
 Rotary Servomotors: Approx. 3 rotations
 Direct Drive Servomotors: Approx. 0.3 rotations
 Linear Servomotors: Approx 90 mm
 Set the distance to the following values or higher. To ensure tuning precision, we recommend that you use approximately the default distance setting.
 Rotary Servomotors: 0.5 rotations
 Direct Drive Servomotors: 0.05 rotations
 Linear Servomotors: 5 mm

• **Mechanism selection Box**

Select the type according to the machine element to drive.
 If there is noise or if the gain does not increase, better results may be obtained by changing the rigidity type. Select the type according to the following guidelines.

Mechanism Selection	Description
1: Belt mechanism	Tuning is performed for a mechanism with relatively low rigidity, e.g., a belt.
2: Ball screw mechanism or linear motor	Tuning is performed for a mechanism with relatively high rigidity, e.g., a ball screw or Linear Servomotor. Use this setting if there is no other appropriate setting.
3: Rigid model	Tuning is performed for a mechanism with high rigidity, e.g., a rigid body system.

• **Tuning parameters Box**

Specify the parameters to use for tuning.
 If you select the **Start tuning using the default settings** Check Box, the tuning parameters will be returned to the default settings before tuning is started.

7. Click the **Servo ON** Button.

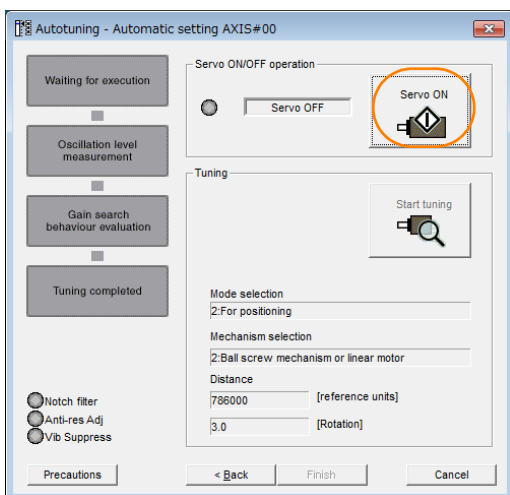

8. Click the **Start tuning** Button.

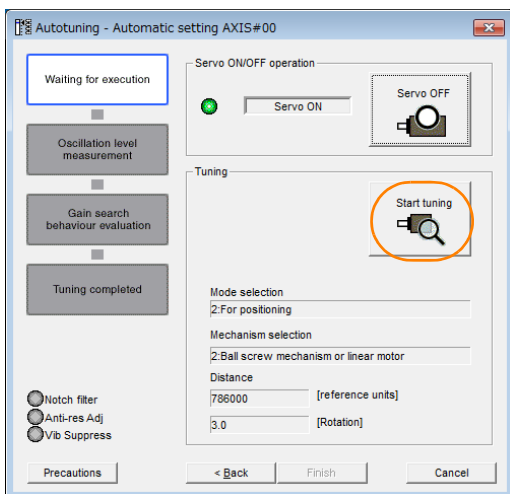

9. Confirm safety around moving parts and click the **Yes** Button.

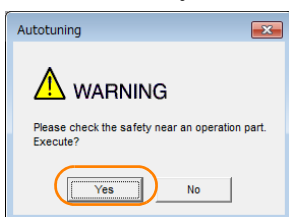

The Servomotor will start operating and tuning will be executed. Vibration that occurs during tuning will be detected automatically and suitable settings will be made for that vibration. When the settings have been completed, the indicators for the functions that were used will light at the lower left of the dialog box.

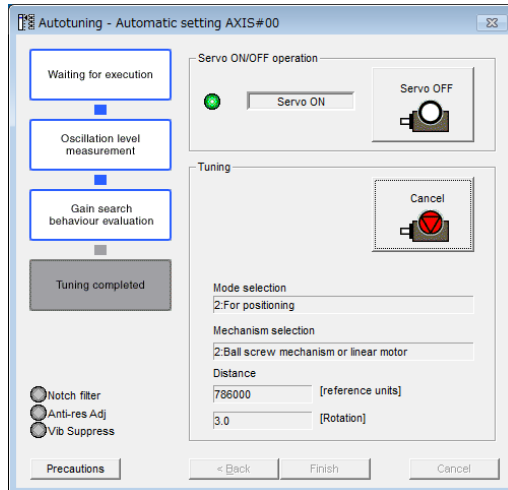

10. When tuning has been completed, click the **Finish** Button.

The results of tuning will be set in the parameters and you will return to the Tuning Dialog Box.

This concludes the procedure to perform autotuning without a host reference.

8.6.5 Troubleshooting Problems in Autotuning without a Host Reference

The following tables give the causes of and corrections for problems that may occur in autotuning without a host reference.

◆ Autotuning without a Host Reference Was Not Performed

Possible Cause	Corrective Action
Main circuit power supply is OFF.	Turn ON the main circuit power supply.
An alarm or warning occurred.	Remove the cause of the alarm or warning.
Overtraveling occurred.	Remove the cause of overtraveling.
The second gains were selected with the gain selection.	Disable automatic gain switching.
The HWBB was activated.	Release the HWBB.
The setting of the travel distance is too small.	Set the travel distance again in step 6 of the procedure.
The settings for the tuning-less function are not correct.	<ul style="list-style-type: none"> • Disable the tuning-less function (Pn170 = n.□□□0). • Enable the tuning-less function (Pn170 = n.□□□1) and specify moment of inertia estimation.

◆ **When an Error Occurs during Execution of Autotuning without a Host Reference**

Error	Possible Cause	Corrective Action
The gain adjustments were not successfully completed.	Machine vibration occurs or the positioning completion signal is not stable when the Servomotor stops.	<ul style="list-style-type: none"> • Increase the setting of the positioning completed width (Pn522). • Change the mode from 2 to 3. • If machine vibration occurs, suppress the vibration with the anti-resonance control adjustment and the vibration suppression function.
An error occurred during calculation of the moment of inertia.	Refer to the following section for troubleshooting information.  ◆ <i>When an Error Occurs during Calculation of Moment of Inertia on page 8-30</i>	
Positioning was not completed within approximately 10 seconds after position adjustment was completed.	The positioning completed width is too narrow.	Increase the setting of the positioning completed width (Pn522).

◆ **When an Error Occurs during Calculation of Moment of Inertia**

Possible Cause	Corrective Action
The SERVOPACK started calculating the moment of inertia but the calculation was not completed.	<ul style="list-style-type: none"> • Increase the setting of the speed loop gain (Pn100). • Increase the stroke (travel distance).
The moment of inertia fluctuated greatly and did not converge within 10 tries.	Set Pn103 (Moment of Inertia Ratio) from the machine specifications and specify not estimating the moment of inertia.
Low-frequency vibration was detected.	Double the setting of moment of inertia calculation starting level (Pn324).
The torque limit was reached.	<ul style="list-style-type: none"> • If you are using the torque limit, increase the torque limit. • Double the setting of moment of inertia calculation starting level (Pn324).

◆ **Adjustment Results Are Not Satisfactory for Position Control**

You may be able to improve the adjustment results by changing the settings of the positioning completed width (Pn522) and the electronic gear (Pn20E/Pn210).

If satisfactory results are still not possible, adjust the overshoot detection level (Pn561). That may improve the adjustment results.

- Pn561 = 100% (default setting)
This will allow tuning with overshooting that is equivalent to the positioning completed width.
- Pn561 = 0%
This will allow tuning to be performed without overshooting within the positioning completed width, but the positioning completed width may be extended.

Pn561	Overshoot Detection Level				
	Setting Range	Setting Unit	Default Setting	When Enabled	Classification
	0 to 100	1%	100	Immediately	Setup

8.6.6 Automatically Adjusted Function Settings

You can specify whether to automatically adjust the following functions during autotuning.

◆ Automatic Notch Filters

Normally, set Pn460 to n.□1□□ (Adjust automatically) (default setting).

Vibration will be detected during autotuning without a host reference and a notch filter will be adjusted.

Set Pn460 to n.□0□□ (Do not adjust automatically) only if you do not change the setting of the notch filter before you execute this function.

Parameter	Function	When Enabled	Classification
Pn460	n.□□□0	Immediately	Tuning
	n.□□□1 (default setting)		
	n.□0□□		
	n.□1□□ (default setting)		

◆ Anti-Resonance Control Adjustment

This function reduces low vibration frequencies, for which the notch filters cannot be used.

Normally, set Pn160 to n.□□1□ (Adjust automatically) (default setting).

Vibration will be detected during autotuning without a host reference and anti-resonance control will be automatically adjusted.

Parameter	Function	When Enabled	Classification
Pn160	n.□□0□	Immediately	Tuning
	n.□□1□ (default setting)		

◆ Vibration Suppression

You can use vibration suppression to suppress transitional vibration at a low frequency from 1 Hz to 100 Hz, which is generated mainly when the machine vibrates during positioning.

Normally, set Pn140 to n.□1□□ (Adjust automatically) (default setting).

Vibration will be detected during autotuning without a host reference and vibration suppression control will be automatically set.

Set Pn140 = n.□0□□ (Do not adjust automatically) only if you do not change the settings for vibration suppression before you execute autotuning without a host reference.

Note: Autotuning without a host reference uses model following control. Therefore, it can be executed only if the mode is set to 2 or 3.

Parameter		Function	When Enabled	Classification
Pn140	n.□0□□	Do not adjust vibration suppression automatically during execution of autotuning without a host reference, autotuning with a host reference, and custom tuning.	Immediately	Tuning
	n.□1□□ (default setting)	Adjust vibration suppression automatically during execution of autotuning without a host reference, autotuning with a host reference, and custom tuning.		

◆ Friction Compensation

Friction compensation compensates for changes in the following conditions.

- Changes in the viscous resistance of the lubricant, such as grease, on the sliding parts of the machine
- Changes in the friction resistance resulting from variations in the machine assembly
- Changes in the friction resistance due to aging

The conditions for applying friction compensation depend on the mode selection.

Mode Selection Settings	Friction Compensation
1: Standard	Based on the setting of Pn408 = n.X□□□ (Friction Compensation Function Selection)*
2: For position control	Adjusted with friction compensation.
3: For position control (emphasis on overshooting)	

Parameter		Function	When Enabled	Classification
Pn408	n.0□□□ (default setting)	Disable friction compensation.	Immediately	Setup
	n.1□□□	Enable friction compensation.		

* Refer to the following section for details.

 Required Parameter Settings on page 8-67

8.6.7 Related Parameters

The following parameters are automatically adjusted or used as reference when you execute autotuning without a host reference.

Do not change the settings while autotuning without a host reference is being executed.

Parameter	Name	Automatic Changes
Pn100	Speed Loop Gain	Yes
Pn101	Speed Loop Integral Time Constant	Yes
Pn102	Position Loop Gain	Yes
Pn103	Moment of Inertia Ratio	Yes
Pn121	Friction Compensation Gain	Yes
Pn123	Friction Compensation Coefficient	Yes
Pn124	Friction Compensation Frequency Correction	No
Pn125	Friction Compensation Gain Correction	Yes
Pn401	First Stage First Torque Reference Filter Time Constant	Yes
Pn408	Torque-Related Function Selections	Yes
Pn409	First Stage Notch Filter Frequency	Yes
Pn40A	First Stage Notch Filter Q Value	Yes
Pn40C	Second Stage Notch Filter Frequency	Yes
Pn40D	Second Stage Notch Filter Q Value	Yes
Pn140	Model Following Control-Related Selections	Yes
Pn141	Model Following Control Gain	Yes
Pn142	Model Following Control Gain Correction	Yes
Pn143	Model Following Control Bias in the Forward Direction	Yes
Pn144	Model Following Control Bias in the Reverse Direction	Yes
Pn145	Vibration Suppression 1 Frequency A	Yes
Pn146	Vibration Suppression 1 Frequency B	Yes
Pn147	Model Following Control Speed Feedforward Compensation	Yes
Pn160	Anti-Resonance Control-Related Selections	Yes
Pn161	Anti-Resonance Frequency	Yes
Pn163	Anti-Resonance Damping Gain	Yes
Pn531	Program Jog Operation Travel Distance	No
Pn533	Program Jog Operation Movement Speed for Rotary Servo-motor	No
Pn585	Program Jog Operation Movement Speed for Linear Servo-motor	No
Pn534	Program Jog Operation Acceleration/Deceleration Time	No
Pn535	Program Jog Operation Waiting Time	No
Pn536	Program Jog Operation Number of Movements	No

Yes: The parameter is automatically set.

No: The parameter is not automatically set, but the setting is read during execution.

8.7 Autotuning with a Host Reference

This section describes autotuning with a host reference.



Autotuning with a host reference makes adjustments based on the set speed loop gain (Pn100). Therefore, precise adjustments cannot be made if there is vibration when adjustments are started. Make adjustments after lowering the speed loop gain (Pn100) until vibration is eliminated.

8.7.1 Outline

Autotuning with a host reference automatically makes optimum adjustments for operation references from the host controller.

The following items are adjusted automatically.

- Gains (e.g., speed loop gain and position loop gain)
- Filters (torque reference filter and notch filters)
- Friction compensation
- Anti-resonance control
- Vibration suppression

Refer to the following section for details on the parameters that are adjusted.

 8.7.7 Related Parameters on page 8-40

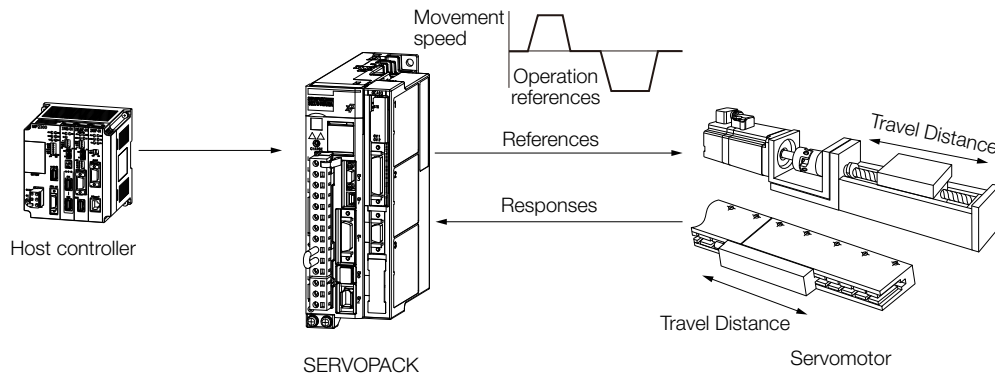

CAUTION

- Because autotuning with a host reference adjusts the SERVOPACK during automatic operation, vibration or overshooting may occur. To ensure safety, make sure that you can perform an emergency stop at any time.

8.7.2 Restrictions

Systems for Which Adjustments Cannot Be Made Accurately

Adjustments will not be made correctly for autotuning with a host reference in the following cases. Use custom tuning.

- When the travel distance for the reference from the host controller is equal to or lower than the setting of the positioning completed width (Pn522)
- Rotary Servomotors: When the movement speed for the reference from the host controller is equal to or lower than the setting of the rotation detection level (Pn502)
- Linear Servomotors: When the movement speed for the reference from the host controller is equal to or lower than the setting of the zero speed level (Pn581)
- When the time required to stop is 10 ms or less
- When the rigidity of the machine is low and vibration occurs when positioning is performed
- When the position integration function is used
- When mode switching is used
- When the positioning completed width (Pn522) is too narrow

Refer to the following sections for details on custom tuning.

 8.8 Custom Tuning on page 8-41



Preparations

Always check the following before you execute autotuning with a host reference.

- The servo must be in ready status.
- There must be no overtravel.
- The servo must be OFF.
- The gain switching selection must be set to disable automatic gain switching (Pn139 = n.□□□0).
- The first gains must be selected.
- The test without a motor function must be disabled (Pn00C = n.□□□0).
- There must be no warnings.
- The tuning-less function must be disabled (Pn170 = n.□□□0).
- The parameters must not be write prohibited.

8.7.3 Applicable Tools

The following table lists the tools that you can use to perform autotuning with a host reference.

Tool	Fn No./Function Name	Operating Procedure Reference
Digital Operator	Fn202	 Σ -7-Series Digital Operator Operating Manual (Manual No.: SIEP S800001 33)
SigmaWin+	Tuning - Tuning	 8.7.4 Operating Procedure on page 8-36

8.7.4 Operating Procedure

Use the following procedure to perform autotuning with a host reference.

1. Confirm that the moment of inertia ratio (Pn103) is set correctly.
2. Click the  Servo Drive Button in the workspace of the Main Window of the SigmaWin+.
3. Select **Tuning** in the Menu Dialog Box.
The Tuning Dialog Box will be displayed.
Click the **Cancel** Button to cancel tuning.
4. Click the **Execute** Button.

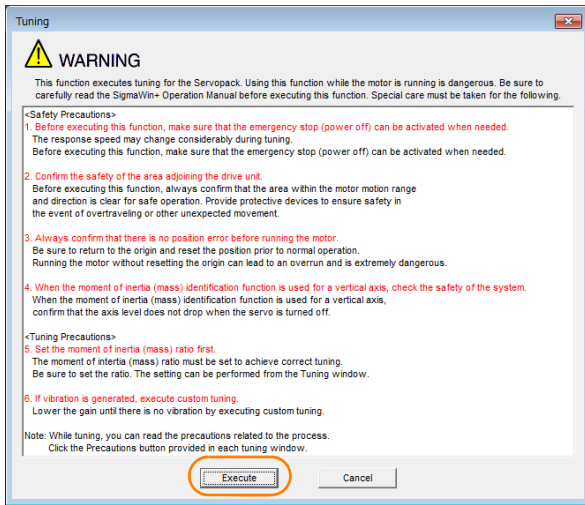

5. Select the **Position reference input** Option in the **Autotuning** Area and then click the **Autotuning** Button.

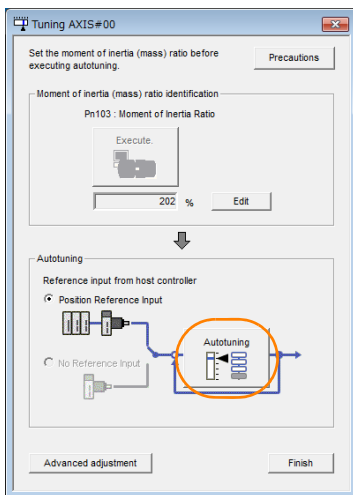

Information When the following dialog box is displayed, click the **OK** Button and then confirm that the correct moment of inertia ratio is set in Pn103 (Moment of Inertia Ratio).

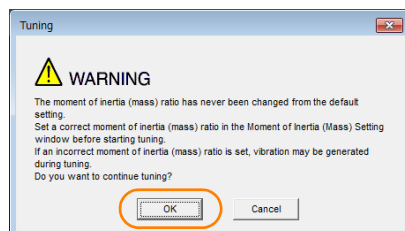

6. Set the conditions in the **Mode selection Box** and the **Mechanism selection Box**, and then click the **Next Button**.
If you select the **Start tuning using the default settings** Check Box in the **Tuning parameters Area**, the tuning parameters will be returned to the default settings before tuning is started.

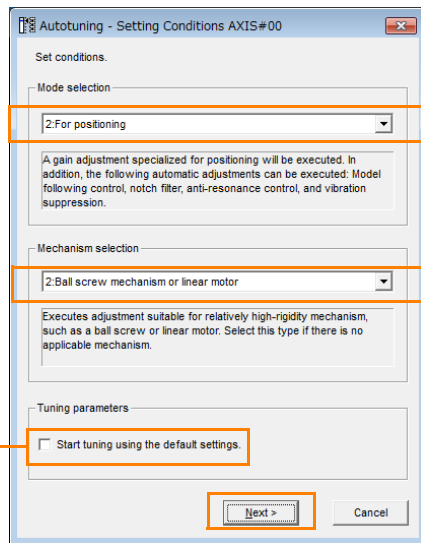

• **Mode selection Box**

Set the mode.

Mode Selection	Description
1: Standard	Standard gain adjustment is performed. In addition to gain adjustment, notch filters and anti-resonance control are automatically adjusted.
2: For positioning	Tuning is performed for positioning applications. In addition to gain adjustment, model following control, notch filters, anti-resonance control, and vibration suppression are automatically adjusted.
3: For positioning especially to prevent overshooting	Tuning is performed for positioning applications with emphasis on eliminating overshooting. In addition to gain adjustment, notch filters, anti-resonance control, and vibration suppression are automatically adjusted.

• **Tuning parameters Box**

Specify the parameters to use for tuning. If you select the **Start tuning using the default settings** Check Box, the tuning parameters will be returned to the default settings before tuning is started.

• **Mechanism selection Box**

Select the type according to the machine element to drive. If there is noise or if the gain does not increase, better results may be obtained by changing the rigidity type. Select the type according to the following guidelines.

Mechanism Selection	Description
1: Belt mechanism	Tuning is performed for a mechanism with relatively low rigidity, e.g., a belt.
2: Ball screw mechanism or linear motor	Tuning is performed for a mechanism with relatively high rigidity, e.g., a ball screw or Linear Servomotor. Use this setting if there is no other appropriate setting.
3: Rigid model	Tuning is performed for a mechanism with high rigidity, e.g., a rigid body system.

7. Click the **Yes Button**.

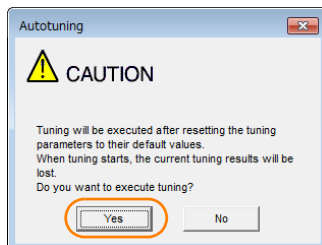

8. Input the correct moment of inertia ratio and click the **Next Button**.

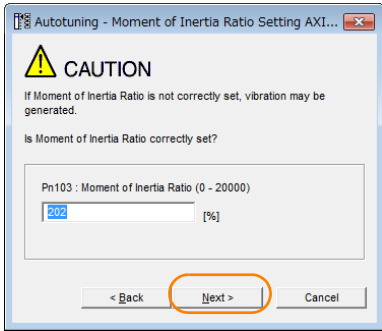

9. First confirm safety around moving parts. Then turn ON the servo, enter a reference from the host controller, and click the **Start tuning Button**.

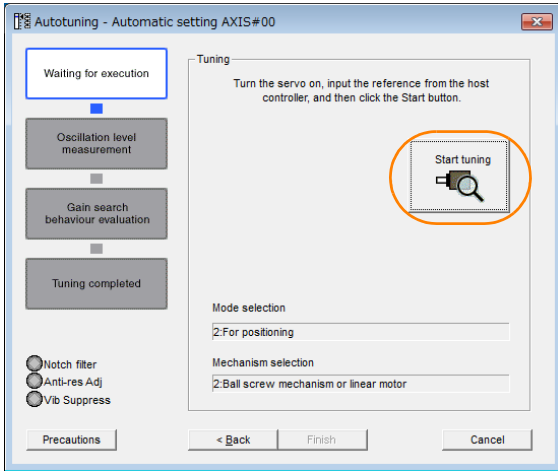

10. Click the **Yes Button**.



Tuning will be executed. Vibration that occurs during tuning will be detected automatically and suitable settings will be made for that vibration. When the settings have been completed, the indicators for the functions that were used will light at the lower left of the dialog box.

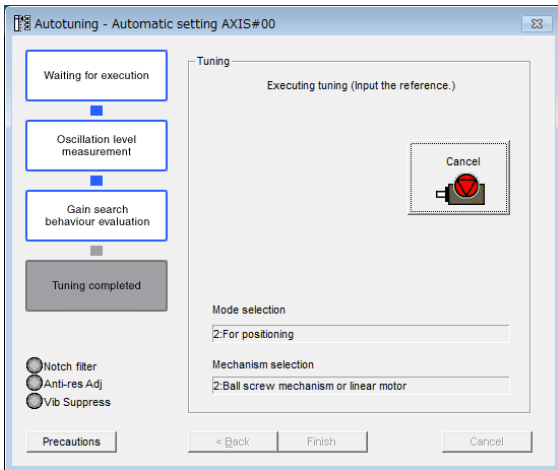

11. When tuning has been completed, click the Finish Button.

The results of tuning will be set in the parameters and you will return to the Tuning Dialog Box.

This concludes the procedure to perform autotuning with a host reference.

8.7.5 Troubleshooting Problems in Autotuning with a Host Reference

The following tables give the causes of and corrections for problems that may occur in autotuning with a host reference.

◆ Autotuning with a Host Reference Was Not Performed

Possible Cause	Corrective Action
Main circuit power supply is OFF.	Turn ON the main circuit power supply.
An alarm or warning occurred.	Remove the cause of the alarm or warning.
Overtraveling occurred.	Remove the cause of overtraveling.
The second gains were selected with the gain selection.	Disable automatic gain switching.
The HWBB was activated.	Release the HWBB.

◆ Troubleshooting Errors

Error	Possible Cause	Corrective Action
The gain adjustments were not successfully completed.	Machine vibration occurs or positioning completion is not stable when the Servomotor stops.	<ul style="list-style-type: none"> • Increase the setting of the positioning completed width (Pn522). • Change the mode from 2 to 3. • If machine vibration occurs, suppress the vibration with the anti-resonance control adjustment and the vibration suppression function.
Positioning was not completed within approximately 10 seconds after positioning adjustment was completed.	The positioning completed width is too narrow.	<ul style="list-style-type: none"> • Increase the setting of the positioning completed width (Pn522).

◆ Adjustment Results Are Not Satisfactory for Position Control

You may be able to improve the adjustment results by changing the settings of the positioning completed width (Pn522) and the electronic gear ratio (Pn20E/Pn210).

If satisfactory results are still not possible, adjust the overshoot detection level (Pn561). That may improve the adjustment results.

- Pn561 = 100% (default setting)
This will allow tuning with overshooting that is equivalent to the positioning completed width.
- Pn561 = 0%
This will allow tuning to be performed without overshooting within the positioning completed width, but the positioning completed width may be extended.

Pn561	Overshoot Detection Level				
	Setting Range	Setting Unit	Default Setting	When Enabled	Classification
	0 to 100	1%	100	Immediately	Setup

8.7.6 Automatically Adjusted Function Settings

These function settings are the same as for autotuning without a host reference. Refer to the following section.

 8.6.6 Automatically Adjusted Function Settings on page 8-31

8.7.7 Related Parameters

The following parameters are automatically adjusted or used as reference when you execute autotuning with a host reference.

Do not change the settings while autotuning with a host reference is being executed.

Parameter	Name	Automatic Changes
Pn100	Speed Loop Gain	Yes
Pn101	Speed Loop Integral Time Constant	Yes
Pn102	Position Loop Gain	Yes
Pn103	Moment of Inertia Ratio	No
Pn121	Friction Compensation Gain	Yes
Pn123	Friction Compensation Coefficient	Yes
Pn124	Friction Compensation Frequency Correction	No
Pn125	Friction Compensation Gain Correction	Yes
Pn401	First Stage First Torque Reference Filter Time Constant	Yes
Pn408	Torque-Related Function Selections	Yes
Pn409	First Stage Notch Filter Frequency	Yes
Pn40A	First Stage Notch Filter Q Value	Yes
Pn40C	Second Stage Notch Filter Frequency	Yes
Pn40D	Second Stage Notch Filter Q Value	Yes
Pn140	Model Following Control-Related Selections	Yes
Pn141	Model Following Control Gain	Yes
Pn142	Model Following Control Gain Correction	Yes
Pn143	Model Following Control Bias in the Forward Direction	Yes
Pn144	Model Following Control Bias in the Reverse Direction	Yes
Pn145	Vibration Suppression 1 Frequency A	Yes
Pn146	Vibration Suppression 1 Frequency B	Yes
Pn147	Model Following Control Speed Feedforward Compensation	Yes
Pn160	Anti-Resonance Control-Related Selections	Yes
Pn161	Anti-Resonance Frequency	Yes
Pn163	Anti-Resonance Damping Gain	Yes

Yes: The parameter is automatically set.

No: The parameter is not automatically set, but the setting is read during execution.

8.8 Custom Tuning

This section describes custom tuning.

8.8.1 Outline

You can use custom tuning to manually adjust the servo during operation using a reference input from the host controller. You can use it to fine-tune adjustments that were made with autotuning.

The following items are adjusted automatically.

- Gains (e.g., speed loop gain and position loop gain)
- Filters (torque reference filter and notch filters)
- Friction compensation
- Anti-resonance control

Refer to the following section for details on the parameters that are adjusted.

 [8.8.7 Related Parameters](#) on page 8-48

There are two adjustment methods that you can use for custom tuning.

- **Tuning Mode 0 (Setting Servo Gains Giving Priority to Stability) or 1 (Setting Servo Gains Giving Priority to Good Response)**

These modes allow you to set stable control conditions for multiple servo gains by manipulating only one tuning level. Automatic setting of notch filters and anti-resonance control is provided if vibration is detected. Manual anti-resonance control adjustment is also possible during custom tuning.

- **Tuning Mode 2 (Setting Servo Gains Giving Priority to Position Control Applications) or 3 (Setting Servo Gains Giving Priority to Preventing Overshooting in Position Control Applications)**

Two tuning levels are manipulated to reduce positioning time even further and set multiple servo gains.

Model following control is used to reduce the positioning time. If vibration is detected, notch filters and anti-resonance control are automatically adjusted, and friction compensation is automatically set. Manual anti-resonance control adjustment and vibration suppression are also possible during custom tuning.

CAUTION

- Vibration or overshooting may occur during custom tuning. To ensure safety, make sure that you can perform an emergency stop at any time.

8.8.2 Preparations

Always check the following before you execute custom tuning.

- The test without a motor function must be disabled (Pn00C = n.□□□0).
- The tuning-less function must be disabled (Pn170 = n.□□□0).
- The parameters must not be write prohibited.

8.8.3 Applicable Tools

The following table lists the tools that you can use to perform custom tuning.

Tool	Fn No./Function Name	Operating Procedure Reference
Digital Operator	Fn203	Σ-7-Series Digital Operator Operating Manual (Manual No.: SIEP S800001 33)
SigmaWin+	<i>Tuning - Tuning</i>	8.8.4 Operating Procedure on page 8-42

8.8.4 Operating Procedure

Use the following procedure to perform custom tuning.

WARNING

- Before you execute custom tuning, check the information provided in the SigmaWin+ operating manual. Observe the following precautions.
 - Make sure that you can perform an emergency stop at any time. When custom tuning is started, several parameters will be overwritten with the recommended settings, which may greatly affect the response before and after execution. Make sure that you can perform an emergency stop at any time.
 - Set the moment of inertia correctly before you execute custom tuning. If the setting greatly differs from the actual moment of inertia, vibration may occur.
 - If you change the feedforward level, the new setting will not be used immediately. It will be used after positioning is completed.

1. Confirm that the moment of inertia ratio (Pn103) is set correctly.
2. Click the Servo Drive Button in the workspace of the Main Window of the SigmaWin+.
3. Select **Tuning** in the Menu Dialog Box. The Tuning Dialog Box will be displayed. Click the **Cancel** Button to cancel tuning.
4. Click the **Execute** Button.

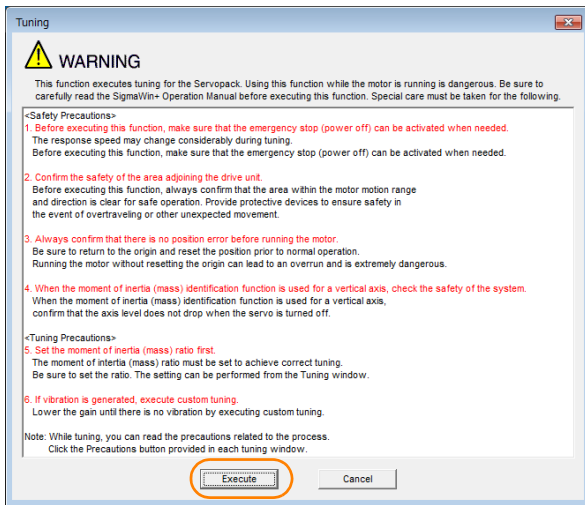

5. Click the **Advanced adjustment** Button.

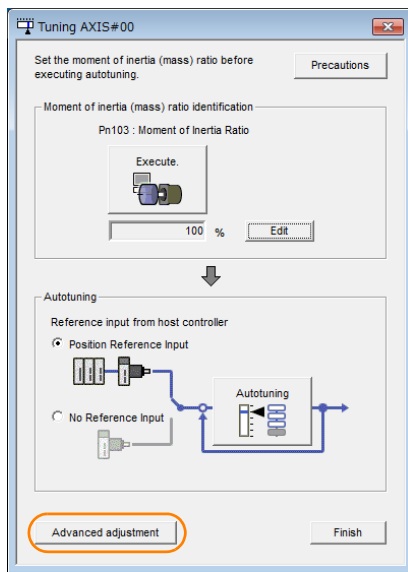

Information When the following dialog box is displayed, click the **OK** Button and then confirm that the correct moment of inertia ratio is set in Pn103 (Moment of Inertia Ratio).

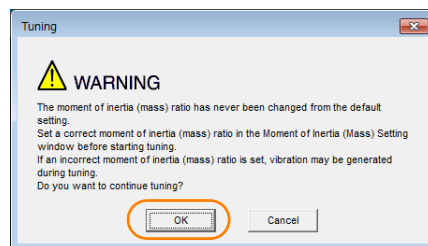

6. Click the **Custom tuning** Button.

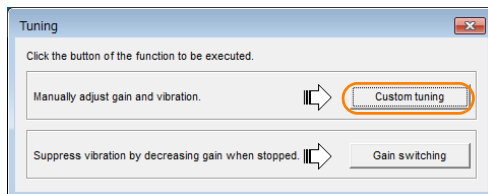

7. Set the Tuning mode Box and Mechanism selection Box, and then click the Next Button.

Tuning mode Box

Mode Selection	Description
0: Set servo gains with priority given to stability.	This setting gives priority to stability and preventing overshooting. In addition to gain adjustment, notch filters and anti-resonance control (except during torque control) are automatically adjusted.
1: Set servo gains with priority given to response.	Overshooting may occur because priority is given to response. In addition to gain adjustment, notch filters and anti-resonance control (except during torque control) are automatically adjusted.
2: Set servo gains for positioning application.	Tuning is performed for positioning applications. In addition to gain adjustment, notch filters, anti-resonance control, and vibration suppression are adjusted.
3: Set servo gains especially to prevent overshooting during positioning application.	Tuning is performed for positioning applications with emphasis on eliminating overshooting. In addition to gain adjustment, notch filters, anti-resonance control, and vibration suppression are adjusted.

• **Mechanism Selection Box**

Select the type according to the machine element to drive. If there is noise or if the gain does not increase, better results may be obtained by changing the rigidity type. Select the type according to the following guidelines.

Mechanism Selection	Description
1: Belt mechanism	Tuning is performed for a mechanism with relatively low rigidity, e.g., a belt.
2: Ball screw mechanism or Linear motor	Tuning is performed for a mechanism with relatively high rigidity, e.g., a ball screw or Linear Servomotor. Use this setting if there is no other appropriate setting.
3: Rigid body system	Tuning is performed for a mechanism with high rigidity, e.g., a rigid body system.

Information The tuning modes that you can select depend on the SERVOPACK setting.

8. If the moment of inertia ratio is not set correctly, correct the setting and then click the Next Button.

9. Turn ON the servo, enter a reference from the host controller, and then click the **Start tuning Button**.

Tuning Mode 0 or 1

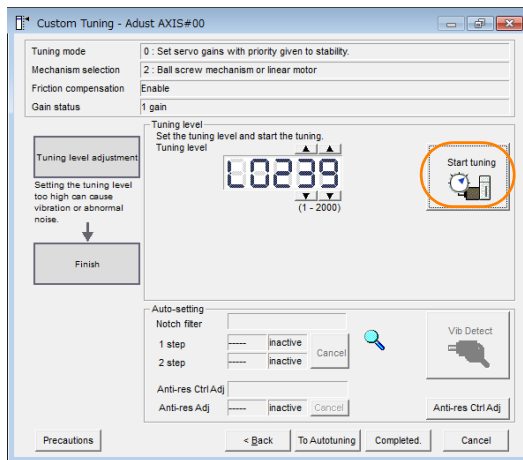

Tuning Mode 2 or 3

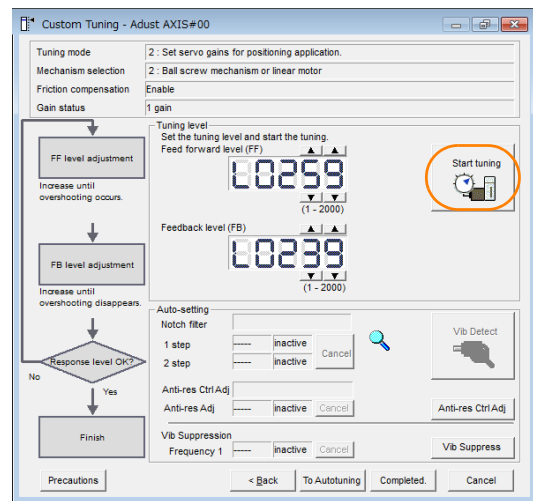

10. Use the ▲ and ▼ Buttons to change the tuning level.

Click the **Back Button** during tuning to restore the setting to its original value. The tuning level will return to the value from before when custom tuning was started.

Tuning Mode 0 or 1

Increase the tuning level until overshooting occurs.

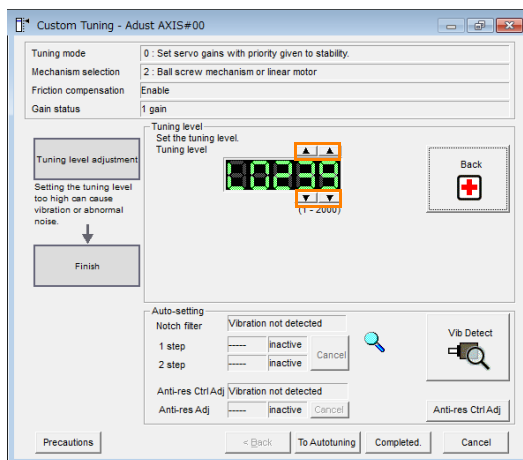

Tuning Mode 2 or 3

Increase the feedforward level until overshooting occurs and then increase the feedback level until overshooting is eliminated. Repeat these changes to make the adjustment.

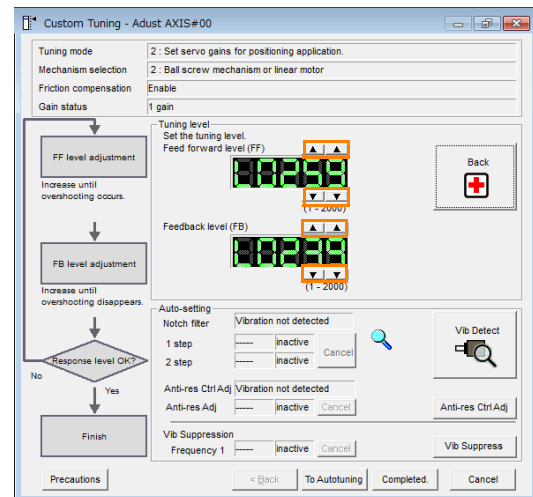

Information The new feedforward level will not be used until the positioning completed signal is output.

11. You can set the functions to suppress vibration (notch filters, automatic anti-resonance control setting, anti-resonance control adjustment, and autotuning with a host reference) as required.

Refer to the following section for details.

Vibration Suppression Functions on page 8-46

12. When tuning has been completed, click the Completed Button.

The values that were changed will be saved in the SERVOPACK and you will return to the Tuning Dialog Box.

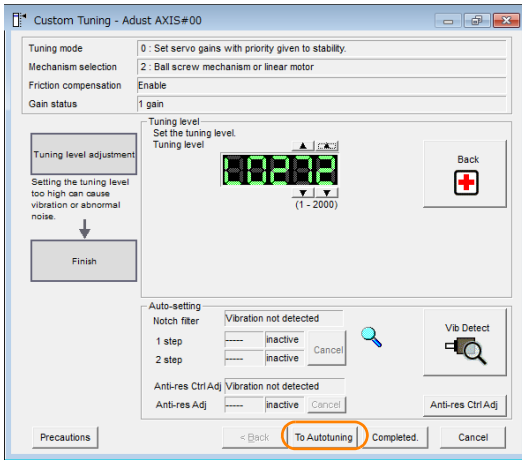

This concludes the procedure to set up custom tuning.

Vibration Suppression Functions

◆ Notch Filters and Automatic Anti-resonance Control Setting

If the vibration frequency that occurs when you increase the servo gains is at 1,000 Hz or higher, notch filters are effective to suppress vibration. If the vibration is between 100 Hz and 1,000 Hz, anti-resonance control is effective.

◆ Automatic Setting

To set vibration suppression automatically, use the parameters to enable notch filters and automatic anti-resonance control setting.

The notch filter frequency (stage 1 or 2) or anti-resonance control frequency that is effective for the vibration that was detected during tuning will be automatically set.

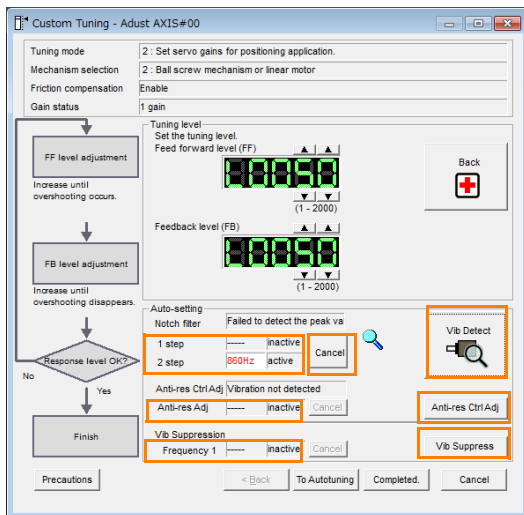

- **Auto-setting Cancel Buttons**

The automatically set notch filter frequencies or the anti-resonance control frequencies may not always suppress vibration. Click the **Cancel** Button to reset the notch filter frequencies or the anti-resonance control frequencies to the values from just before these frequencies were set automatically.

When they are reset, vibration detection will start again.

- **Vib Detect** Button

While the notch filter or automatic anti-resonance control setting function is enabled, you can click the **Vib Detect** Button to manually detect vibration. When you click the **Vib Detect** Button, the SERVOPACK will detect vibration at that time, and set the notch filter frequency (stage 1 or 2) or anti-resonance control frequency that is effective for the detected vibration. You can also perform manual vibration detection even when the SERVOPACK does not detect vibration.

- **Anti-res Ctrl Adj** Button

You can use the **Anti-res Ctrl Adj** Button to execute the anti-resonance control adjustment if fine-tuning is required. Refer to the following section.

 8.9 Anti-Resonance Control Adjustment on page 8-49

- **Vib Suppress** Button

Click the **Vib Suppress** Button to suppress low and transient vibration (oscillation) of approximately 1 Hz to 100 Hz that occurs during positioning. Refer to the following section.

 8.10 Vibration Suppression on page 8-54

◆ Autotuning with a Host Reference

You can perform autotuning with a host reference. Refer to the following section for details.

 8.7 Autotuning with a Host Reference on page 8-34

8.8.5 Automatically Adjusted Function Settings

You cannot use vibration suppression functions at the same time. Other automatic function settings are the same as for autotuning without a host reference. Refer to the following section.

 8.6.6 Automatically Adjusted Function Settings on page 8-31

8.8.6 Tuning Example for Tuning Mode 2 or 3

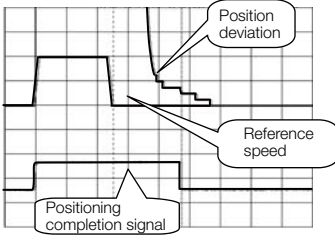
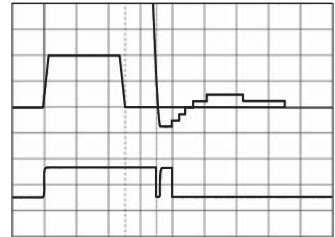
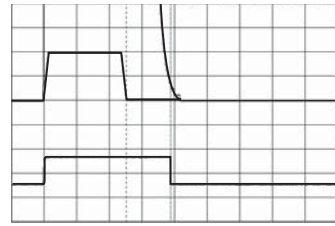
Step	Measurement Display Examples	Operation
1		The positioning time is measured after the moment of inertia ratio (Pn103) is set correctly. Tuning is completed if the specifications are met. The tuning results are saved in the SERVOPACK.
2		The positioning time will be reduced if the feedforward level is increased. Tuning is completed if the specifications are met. The tuning results are saved in the SERVOPACK. If overshooting occurs before the specifications are met, proceed to step 3.
3		Overshooting will be reduced if the feedback level is increased. If the overshooting is eliminated, proceed to step 4.

Continued on next page.

Continued from previous page.

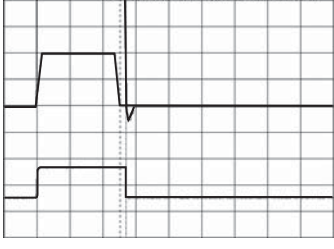
Step	Measurement Display Examples	Operation
4		The graph shows overshooting that occurred when the feed-forward level was increased even more after step 3. In this state, overshooting occurs, but the positioning settling time is shorter. Tuning is completed if the specifications are met. The tuning results are saved in the SERVOPACK. If overshooting occurs before the specifications are met, repeat steps 3 and 4. If vibration occurs before the overshooting is eliminated, the vibration is suppressed with the notch filters and anti-resonance control.
5	–	The tuning results are saved in the SERVOPACK.

8.8.7 Related Parameters

The following parameters are automatically adjusted or used as reference when you execute custom tuning.

Do not change the settings while custom tuning is being executed.

Parameter	Name	Automatic Changes
Pn100	Speed Loop Gain	Yes
Pn101	Speed Loop Integral Time Constant	Yes
Pn102	Position Loop Gain	Yes
Pn103	Moment of Inertia Ratio	No
Pn121	Friction Compensation Gain	Yes
Pn123	Friction Compensation Coefficient	Yes
Pn124	Friction Compensation Frequency Correction	No
Pn125	Friction Compensation Gain Correction	Yes
Pn401	First Stage First Torque Reference Filter Time Constant	Yes
Pn408	Torque-Related Function Selections	Yes
Pn409	First Stage Notch Filter Frequency	Yes
Pn40A	First Stage Notch Filter Q Value	Yes
Pn40C	Second Stage Notch Filter Frequency	Yes
Pn40D	Second Stage Notch Filter Q Value	Yes
Pn140	Model Following Control-Related Selections	Yes
Pn141	Model Following Control Gain	Yes
Pn142	Model Following Control Gain Correction	Yes
Pn143	Model Following Control Bias in the Forward Direction	Yes
Pn144	Model Following Control Bias in the Reverse Direction	Yes
Pn145	Vibration Suppression 1 Frequency A	No
Pn146	Vibration Suppression 1 Frequency B	No
Pn147	Model Following Control Speed Feedforward Compensation	Yes
Pn160	Anti-Resonance Control-Related Selections	Yes
Pn161	Anti-Resonance Frequency	Yes
Pn163	Anti-Resonance Damping Gain	Yes

Yes: The parameter is automatically set.

No: The parameter is not automatically set, but the setting is read during execution.

8.9

Anti-Resonance Control Adjustment

This section describes anti-resonance control.

8.9.1

Outline

Anti-resonance control increases the effectiveness of vibration suppression after custom tuning.

Anti-resonance control is effective for suppression of continuous vibration frequencies from 100 to 1,000 Hz that occur when the control gain is increased. Vibration can be eliminated by setting vibration frequencies through automatic detection or by manually setting them to adjust the damping gain. Input an operation reference and execute this anti-resonance control adjustment when there is vibration.

Anti-resonance control is automatically set by autotuning without a host reference or autotuning with a host reference. Use anti-resonance control adjustment only if fine-tuning is required or readjustment is required as a result of a failure to detect vibration.

Perform custom tuning if required to increase the response after performing anti-resonance control adjustment. If the control gain is increased, e.g., when custom tuning is performed, vibration may occur again. If that occurs, perform anti-resonance control adjustment again to fine-tune the parameters.

 **CAUTION**

- Related parameters will be set automatically when anti-resonance control adjustment is executed. This may greatly affect the response before and after execution. Make sure that you can perform an emergency stop at any time.
- Before you execute anti-resonance control adjustment, set the correct moment of inertia ratio (Pn103). If the setting greatly differs from the actual moment of inertia ratio, normal control of the machine may not be possible, and vibration may occur.



Important

- Anti-resonance control adjustment detects vibration frequencies between 100 Hz and 1,000 Hz. If the vibration frequency is not within this range, use custom tuning with tuning mode 2 selected to automatically set a notch filter or use vibration suppression.
- Vibration reduction can be made more effective by increasing the anti-resonance damping gain (Pn163), but the vibration may become larger if the damping gain is too high. Increase the damping gain by approximately 0% to 200% in 10% increments while checking the effect on vibration. If vibration reduction is still insufficient at a gain of 200%, cancel the setting, and lower the control gain by using a different method, such as custom tuning.

8.9.2



Preparations

Always check the following before you execute anti-resonance control adjustment.

- The tuning-less function must be disabled (Pn170 = n.□□□0).
- The test without a motor function must be disabled (Pn00C = n.□□□0).
- The parameters must not be write prohibited.

8.9.3 Applicable Tools

The following table lists the tools that you can use to perform anti-resonance control adjustment.

Tool	Fn No./Function Name	Operating Procedure Reference
Digital Operator	Fn204	 Σ -7-Series Digital Operator Operating Manual (Manual No.: SIEP S800001 33)
SigmaWin+	Tuning - Tuning	 8.9.4 Operating Procedure on page 8-50

8.9.4 Operating Procedure

To execute anti-resonance control adjustment, an operation reference is input, and the adjustment is executed while vibration is occurring.

The following methods can be used to execute anti-resonance control adjustment.

- To automatically detect the vibration frequency
- To manually set the vibration frequency

Use the following procedure to perform anti-resonance control.

CAUTION

- Before you execute anti-resonance control adjustment, check the information provided in the SigmaWin+ operating manual. Observe the following precautions.
 - Make sure that you can perform an emergency stop at any time. Parameters will be set automatically when anti-resonance control adjustment is executed. This may greatly affect the response before and after execution. Make sure that you can perform an emergency stop (to turn OFF the power supply) at any time.
 - Set the moment of inertia correctly before you execute anti-resonance control adjustment. If the setting greatly differs from the actual moment of inertia, effective vibration reduction may not be possible.
 - If you have already performed anti-resonance control adjustment and then you change the frequency, the current anti-resonance control effect may be lost. Caution is particularly required when automatically detecting the vibration frequency.
 - If effective vibration reduction is not achieved even after you execute anti-resonance control adjustment, cancel the function and lower the control gain by using a different method, such as custom tuning.
 - Perform custom tuning separately if required to increase the response after performing anti-resonance control adjustment. If the servo gain is increased, e.g., when custom tuning is performed, vibration may occur again. If that occurs, perform anti-resonance control adjustment again to fine-tune the parameters.

1. Perform steps 1 to 8 of the procedure for custom tuning. Refer to the following section for details.

 8.8.4 Operating Procedure on page 8-42

2. Click the **Anti-res Ctrl Adj Button**.

The rest of the procedure depends on whether you know the vibration frequency.

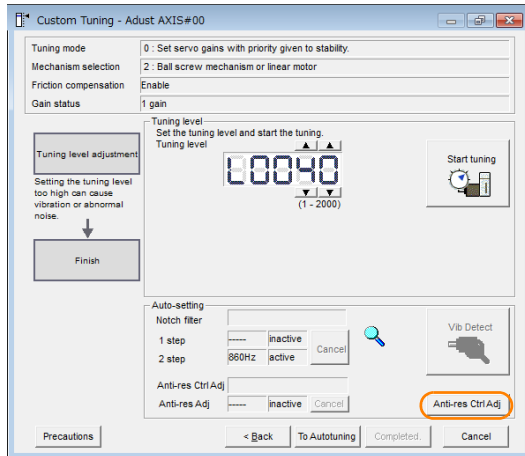

3. If you do not know the vibration frequency, click the **Auto Detect Button**. If you know the vibration frequency, click the **Manual Set Button**.

To Automatically Detect the Vibration Frequency

The frequency will be set.

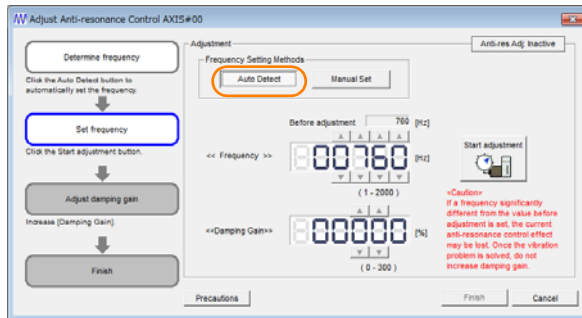

To Manually Set the Vibration Frequency

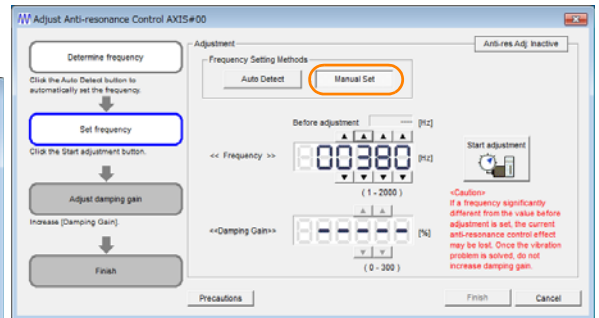

4. Click the **Start adjustment Button**.

5. Use the **▲** and **▼** Buttons in the **Adjustment Area** to change the settings.

Click the **Reset Button** during tuning to restore the setting to its original value. The tuning level will return to the value from before when custom tuning was started.

To Automatically Detect the Vibration Frequency

Change the setting of the damping gain.

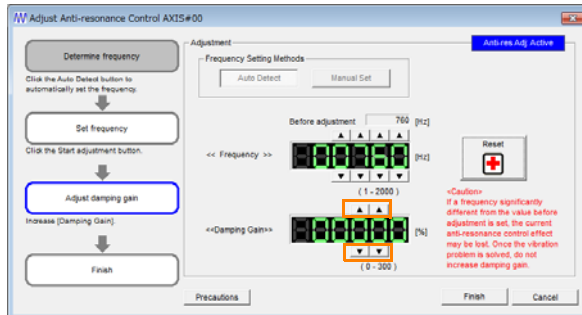

To Manually Set the Vibration Frequency

Change the settings of the frequency and damping gain.

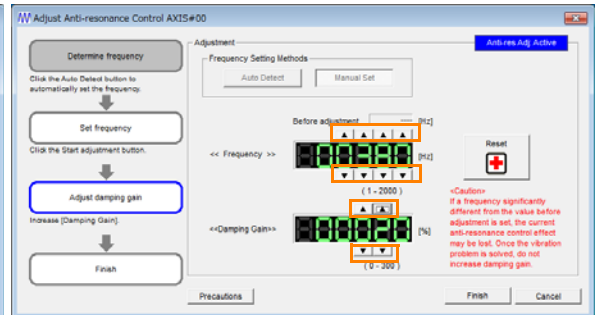

- When the adjustment has been completed, click the **Finish** Button. The values that were changed will be saved in the SERVOPACK and you will return to the Tuning Dialog Box.



This concludes the procedure to set up anti-resonance control.

8.9.5 Related Parameters

The following parameters are automatically adjusted or used as reference when you execute anti-resonance control adjustment.

Do not change the settings while anti-resonance control adjustment is being executed.

Parameter	Name	Automatic Changes
Pn160	Anti-Resonance Control-Related Selections	Yes
Pn161	Anti-Resonance Frequency	Yes
Pn162	Anti-Resonance Gain Correction	No
Pn163	Anti-Resonance Damping Gain	Yes
Pn164	Anti-Resonance Filter Time Constant 1 Correction	No
Pn165	Anti-Resonance Filter Time Constant 2 Correction	No

Yes: The parameter is automatically set.

No: The parameter is not automatically set, but the setting is read during execution.

8.9.6 Suppressing Different Vibration Frequencies with Anti-resonance Control

When you use anti-resonance control and increase the control gain, for some mechanism, vibration can occur at a higher frequency than the frequency for which vibration was suppressed. If this occurs, you can suppress vibration for more than one frequency by adjusting Pn166 (Anti-Resonance Damping Gain 2).

Information

Guidelines for Vibration That Can Be Suppressed

Anti-resonance frequency (Pn161): f_a [Hz], Another vibration frequency that occurs when the control gain is increased: f_b [Hz]

- Vibration frequencies: 100 Hz to 1,000 Hz
- Range of different vibration frequencies: $1 < (f_b/f_a) \leq 3$ to 4

Required Parameter Settings

The following parameter settings are required to use anti-resonance control for more than one vibration frequency.

Parameter		Description	When Enabled	Classification	
Pn160	n.□□□0 (default setting)	Do not use anti-resonance control.	After restart	Setup	
	n.□□□1	Use anti-resonance control.			
Anti-Resonance Frequency					
Pn161	Setting Range	Setting Unit	Default Setting	When Enabled	Classification
	10 to 20,000	0.1 Hz	1000	Immediately	Tuning
Anti-Resonance Gain Correction					
Pn162	Setting Range	Setting Unit	Default Setting	When Enabled	Classification
	1 to 1,000	1%	100	Immediately	Tuning
Anti-Resonance Damping Gain					
Pn163	Setting Range	Setting Unit	Default Setting	When Enabled	Classification
	0 to 300	1%	0	Immediately	Tuning
Anti-Resonance Filter Time Constant 1 Correction					
Pn164	Setting Range	Setting Unit	Default Setting	When Enabled	Classification
	-1,000 to 1,000	0.01 ms	0	Immediately	Tuning
Anti-Resonance Filter Time Constant 2 Correction					
Pn165	Setting Range	Setting Unit	Default Setting	When Enabled	Classification
	-1,000 to 1,000	0.01 ms	0	Immediately	Tuning
Anti-Resonance Damping Gain 2					
Pn166	Setting Range	Setting Unit	Default Setting	When Enabled	Classification
	0 to 1,000	1%	0	Immediately	Tuning

Adjustment Procedure for Suppressing Different Vibration Frequencies with Anti-resonance Control

Use the following procedure to make adjustments to suppress different vibration frequencies with anti-resonance control.

Step	Operation
1	Use the gain adjustment and anti-resonance control. Refer to the following section for details.  8.9.4 Operating Procedure on page 8-50
2	If there is vibration at a higher frequency than the vibration suppressed with anti-resonance control in step 1, adjust Pn166 (Anti-Resonance Damping Gain 2).
3	Adjust Pn166 (Anti-Resonance Damping Gain 2) while checking to see if vibration reduction is effective. To adjust Pn166 (Anti-Resonance Damping Gain 2), increase the setting by 10% at a time starting from the value that resulted in Pn163 (Anti-Resonance Damping Gain) from the adjustment in step 1.
4	If the vibration disappears, the adjustment is completed. However, if the vibration does not disappear even when you adjust Pn166 (Anti-Resonance Damping Gain 2), reduce the tuning level or feedback level until vibration does not occur.

8.10 Vibration Suppression

This section describes vibration suppression.

8.10.1 Outline

You can use vibration suppression to suppress transient vibration at a low frequency from 1 Hz to 100 Hz, which is generated mainly when the machine vibrates during positioning. This is effective for vibration frequencies for which notch filters and anti-resonance control adjustment are not effective.

Vibration suppression is automatically set by autotuning without a host reference or autotuning with a host reference. Use vibration suppression only if fine-tuning is required or readjustment is required as a result of a failure to detect vibration. To execute vibration suppression, input an operation reference and execute the function when there is vibration.

Perform custom tuning if required to increase the response after performing vibration suppression.

 **CAUTION**

- Related parameters will be set automatically when vibration suppression is executed. This may greatly affect the response before and after execution. Make sure that you can perform an emergency stop at any time.
- Before you execute vibration suppression, set the correct moment of inertia ratio (Pn103) with autotuning without a host reference or another method. If the setting greatly differs from the actual moment of inertia ratio, normal control of the machine may not be possible, and vibration may occur.



- Vibration suppression detects vibration frequencies between 1 Hz and 100 Hz.
- Frequency detection will not be performed if there is no vibration in the position deviation or if the vibration frequency is outside the range of detectable frequencies. If that is a problem, use a device such as a displacement meter or vibration sensor to measure the vibration frequency.
- If an automatically detected vibration frequency is not suppressed, the actual frequency and the detected frequency may be different. Fine-tune the detected frequency if necessary.

Items That Influence Performance

If continuous vibration occurs while the Servomotor is stopping, vibration suppression cannot be used to suppress the vibration effectively. In this case, use anti-resonance control adjustment or custom tuning.

Detection of Vibration Frequencies

Frequency detection may not be possible if vibration does not appear in the position deviation or the vibration that results from the position deviation is too small. You can adjust the detection sensitivity by changing the setting of the residual vibration detection width (Pn560), which is set as a percentage of the positioning completed width (Pn522). Perform the detection of vibration frequencies again after adjusting the setting of Pn560.

Pn560	Residual Vibration Detection Width				
	Setting Range	Setting Unit	Default Setting	When Enabled	Classification
	1 to 3,000	0.1%	400	Immediately	Setup

Note: As a guideline, change the setting 10% at a time. If the setting of this parameter is lowered, the detection sensitivity will be increased. Vibration may not be detected accurately if the setting is too small.

Information The vibration frequencies that are automatically detected may vary somewhat with each positioning. Perform positioning several times and make adjustments while checking the effect of vibration suppression.



8.10.2 Preparations

Always check the following before you execute vibration suppression.

- The tuning-less function must be disabled (Pn170 = n.□□□0).
- The test without a motor function must be disabled (Pn00C = n.□□□0).
- The parameters must not be write prohibited.

8.10.3 Applicable Tools

The following table lists the tools that you can use to perform vibration suppression.

Tool	Fn No./Function Name	Operating Procedure Reference
Digital Operator	Fn205	 Σ -7-Series Digital Operator Operating Manual (Manual No.: SIEP S800001 33)
SigmaWin+	<i>Tuning - Tuning</i>	 8.10.4 Operating Procedure on page 8-55

8.10.4 Operating Procedure

Use the following procedure to perform vibration suppression.

1. Perform steps 1 to 8 of the procedure for custom tuning. Refer to the following section for details.

 8.8.4 Operating Procedure on page 8-42

2. Click the **Vib Suppress** Button.

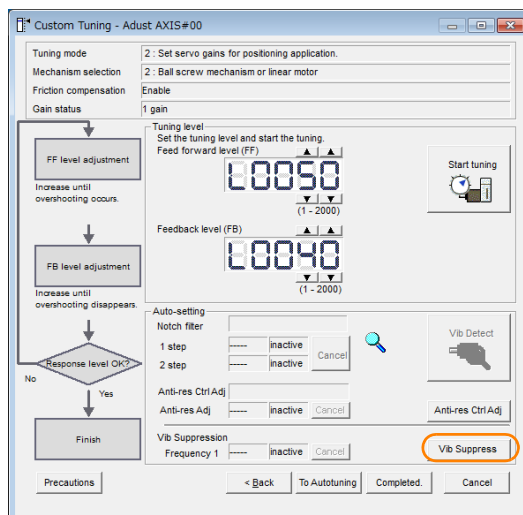

3. Click the **Import Button** or click **▲** and **▼** Button to manually adjust the set frequency. When you click the **Import Button**, the residual vibration frequency in the Servomotor is read as the set frequency. (The frequency can be read only when the residual vibration frequency is between 1.0 and 100.0.)

 **Important** Frequency detection will not be performed if there is no vibration or if the vibration frequency is outside the range of detectable frequencies. If a vibration frequency is not detected, provide a means of measuring the vibration frequency.

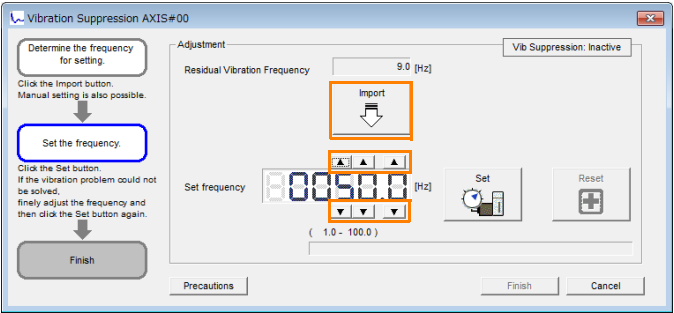

4. Click the **Set Button**.

 **Important** No settings related to vibration suppression are changed during operation. If the Servomotor does not stop within approximately 10 seconds after changing the setting, an update timeout will occur. The setting will be automatically returned to the previous value.

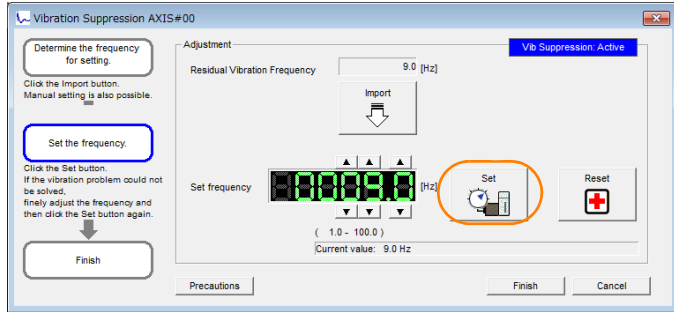

If the vibration is not eliminated, use the **▲** and **▼** Buttons for the set frequency to fine-tune the value and click the **Set** Button again.

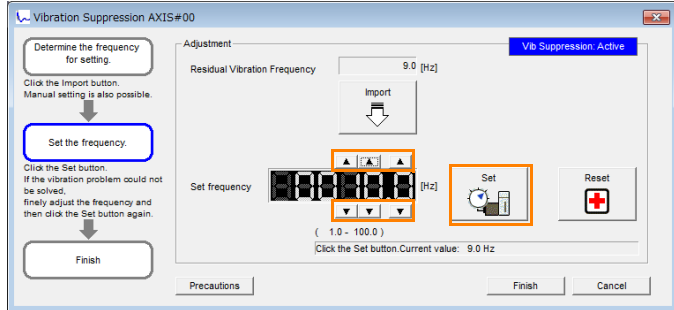

Click the **Reset** Button during adjustment to restore the setting to its original value. The status from before when adjustment was started will be restored.

5. When the vibration has been eliminated, click the **Finish Button**.
The updated value will be saved in the SERVOPACK.



Vibration suppression will be enabled in step 5. The Servomotor response, however, will change when the Servomotor comes to a stop with no reference input.

This concludes the procedure to set up vibration suppression.

8.10.5 Related Parameters

The following parameters are automatically adjusted or used as reference when you execute vibration suppression.

Do not change the settings while vibration suppression is being executed.

Parameter	Name	Automatic Changes
Pn140	Model Following Control-Related Selections	Yes
Pn141	Model Following Control Gain	Yes
Pn142	Model Following Control Gain Correction	No
Pn143	Model Following Control Bias in the Forward Direction	No
Pn144	Model Following Control Bias in the Reverse Direction	No
Pn145	Vibration Suppression 1 Frequency A	Yes
Pn146	Vibration Suppression 1 Frequency B	Yes
Pn147	Model Following Control Speed Feedforward Compensation	No
Pn14A	Vibration Suppression 2 Frequency	No
Pn14B	Vibration Suppression 2 Correction	No

Yes: The parameter is automatically set.

No: The parameter is not automatically set, but the setting is read during execution.

8.11 Speed Ripple Compensation

This section describes speed ripple compensation.

8.11.1 Outline

Speed ripple compensation reduces the amount of ripple in the motor speed due to torque ripple or cogging torque. You can enable speed ripple compensation to achieve smoother operation. To enable it, you must set up ripple compensation on the SigmaWin+.

WARNING

- Speed ripple compensation requires operating the Servomotor and therefore presents hazards. Observe the following precautions.
Confirm safety around moving parts.
This function involves automatic operation. Make sure that you can perform an emergency stop (to turn OFF the power supply) at any time.



Important

Execute speed ripple compensation only after adjusting the gains.

- Reset speed ripple compensation after you replace the Servomotor or SERVOPACK.
- Execute speed ripple compensation after jog operation to a position that ensures a suitable range of motion.

8.11.2 Setting Up Speed Ripple Compensation

Restrictions

The following restrictions apply to the setup for speed ripple compensation.

◆ Systems for Which Execution Cannot Be Performed

There are no restrictions.

◆ Systems for Which Adjustments Cannot Be Made Accurately

Systems for which there is not a suitable range of motion

◆ Preparations

Always check the following before you set up speed ripple compensation.

- The main circuit power supply must be ON.
- The servo must be OFF.
- There must be no alarms or warnings.
- There must be no hard wire base block (HWBB).
- The parameters must not be write prohibited.

Applicable Tools

The following table lists the tools that you can use to set up speed ripple compensation.

Tool	Fn No./Function Name	Reference
Digital Operator	You cannot set up speed ripple compensation from the Digital Operator.	
SigmaWin+	Diagnostic – Ripple Compensation	 <i>Operating Procedure</i> on page 8-59

Operating Procedure

Use the following procedure to set up speed ripple compensation.

1. Click the  Servo Drive Button in the workspace of the Main Window of the SigmaWin+.
2. Select **Ripple Compensation** in the Menu Dialog Box.
The Ripple Compensation Dialog Box will be displayed.
3. Click the **OK** Button.

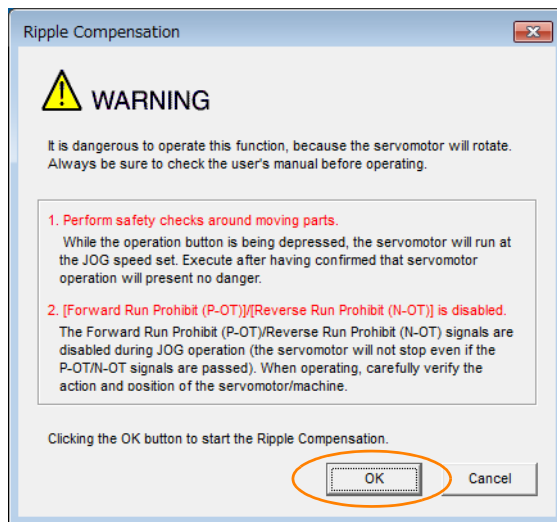

Information

1. Click the **Cancel** Button to cancel ripple compensation. The Main Window will return.
2. If write protection is set, the following dialog box will be displayed.

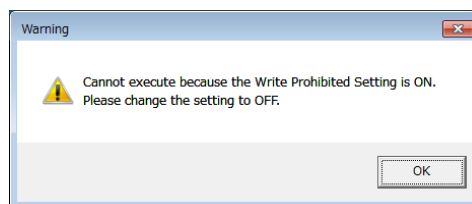

Click the **OK** Button to cancel write prohibition.

8.11 Speed Ripple Compensation

8.11.2 Setting Up Speed Ripple Compensation

4. Click the **Edit** Button.

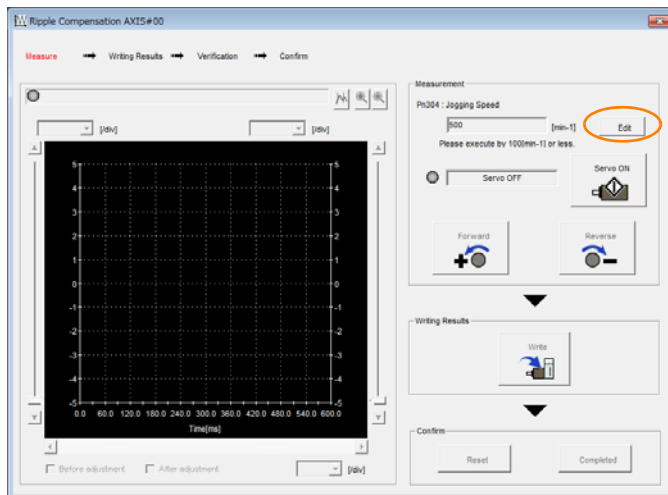

5. Enter the jog operation speed in the **Input Value Box** and click the **OK** Button.

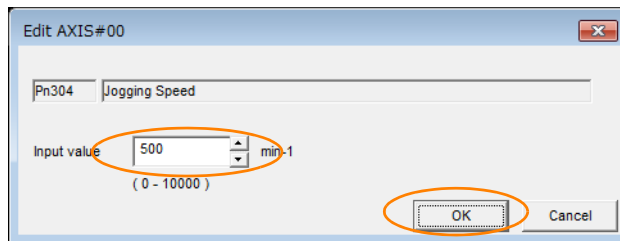

6. Click the **Servo ON** Button.

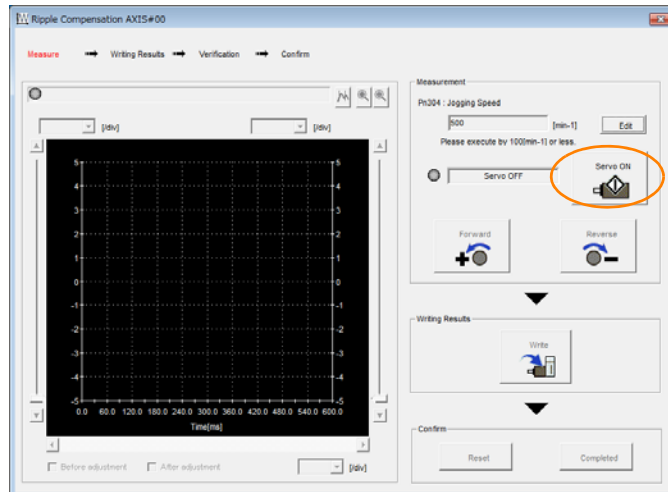

7. Click the **Forward Button** or the **Reverse Button**.

Measurement operation is started.

The Servomotor shaft will rotate at the preset jogging speed while you hold down the **Forward** or **Reverse** Button and the speed ripple will be measured.

The feedback speed and torque reference graph will be displayed in the Ripple Compensation Dialog Box during jog operation.

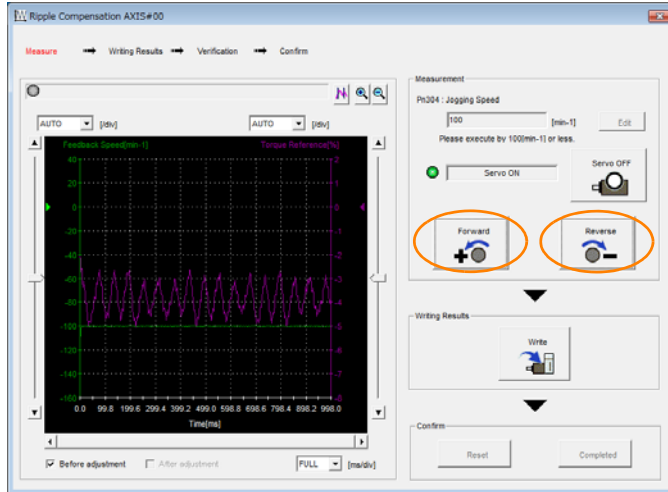

Important

If the measurement time (i.e., the jog operation time) for the speed ripple is too short, speed ripple measurement will not be completed. The following dialog box will be displayed if speed ripple measurement was not completed.

Click the **OK** Button and repeat the measurement.

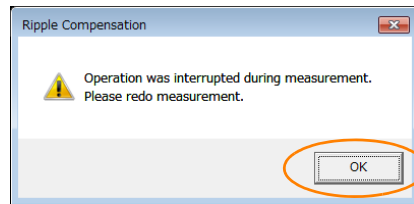

8. After speed ripple measurement has been completed, click the **Write** Button.

The ripple compensation value will be written to the SERVOPACK.

9. After writing has been completed, click the **OK** Button.

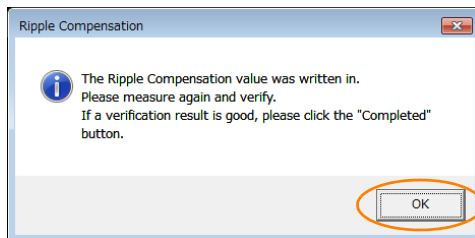

10. Click the Forward Button or the Reverse Button.

Verification operation is started.

The Servomotor shaft will rotate at the preset jogging speed while you hold down the **Forward** or **Reverse** Button.

The waveform with speed ripple compensation applied to it will be displayed.

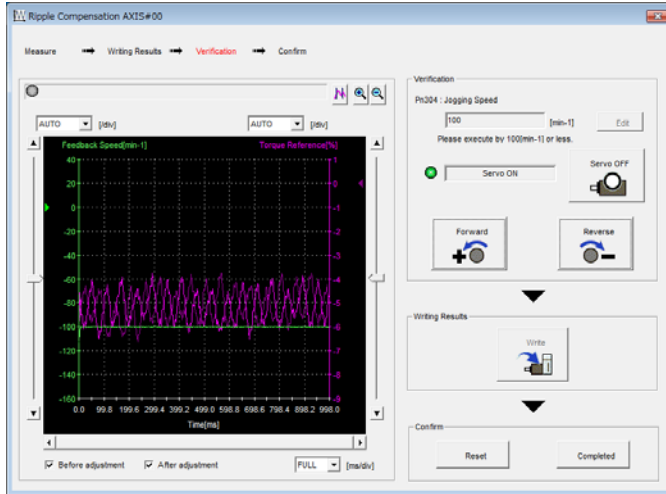

11. If the verification results are OK, click the Finish Button.

Information To discard the setup results, click the **Reset** Button.

This concludes the setup for speed ripple compensation.

8.11.3 Setting Parameters

The function is enabled when you perform the operating procedure on *Operating Procedure* on page 8-59. To cancel speed ripple compensation, use Pn423 = n.□□□0 (Disable speed ripple compensation) to disable it.

Parameter	Description	When Enabled	Classification
Pn423	n.□□□0 (default setting)	Immediately	Setup
	n.□□□1		

If you enable speed ripple compensation, a compensation reference will be applied to reduce ripple even when stopped at a 0 speed reference. In speed control mode, this may result in the Servomotor moving slightly. To prevent this, set Pn423 = n.□X□□ (Speed Ripple Compensation Selections) and Pn427 or Pn49F (Speed Ripple Compensation Enable Speed).

Parameter	Description	When Enabled	Classification
Pn423	n.□0□□ (default setting)	After restart	Setup
	n.□1□□		

- For Rotary Servomotors

Pn427	Speed Ripple Compensation Enable Speed				
	Setting Range	Setting Unit	Default Setting	When Enabled	Classification
	0 to 10,000	1 min ⁻¹	0	Immediately	Tuning

- For Linear Servomotors

Pn49F	Speed Ripple Compensation Enable Speed				
	Setting Range	Setting Unit	Default Setting	When Enabled	Classification
	0 to 10,000	1 mm/s	0	Immediately	Tuning

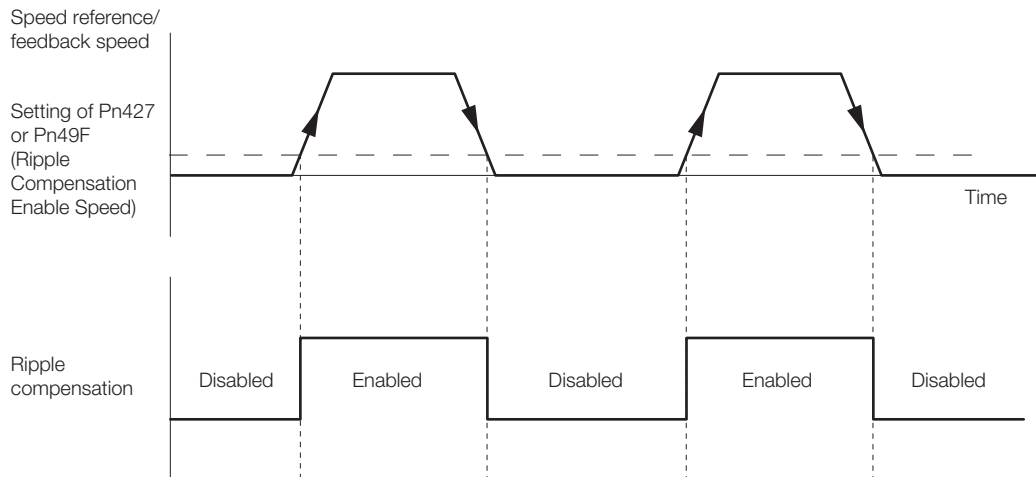

Speed Ripple Compensation Warnings

The speed ripple compensation value is specific to each Servomotor. If you replace the Servomotor while speed ripple compensation is enabled, an A.942 warning (Speed Ripple Compensation Information Disagreement) will occur to warn you.

You can use any of the following methods to clear A.942.

- Reset the speed ripple compensation value on the SigmaWin+.
- Disable speed ripple compensation (Pn423 = n.□□□0).
- Disable detection of A.942 (Pn423 = n.□□1□).

Parameter		Description	When Enabled	Classification
Pn423	n.□□0□ (default setting)	Detect A.942 alarms.	After restart	Setup
	n.□□1□	Do not detect A.942 alarms.		

8.12 Additional Adjustment Functions

This section describes the functions that you can use to make adjustments after you perform autotuning without a host reference, autotuning with a host reference, and custom tuning.

Function	Reference
Automatic Gain Switching	page 8-64
Friction Compensation	page 8-67
Current Control Mode Selection	page 8-70
Current Gain Level Setting	page 8-70
Speed Detection Method Selection	page 8-71
Backlash Compensation	page 8-71

8.12.1 Automatic Gain Switching

You can use gain switching to shorten the positioning time by increasing the gains during positioning and suppressing vibration by decreasing the gains while stopping.

Parameter	Function	When Enabled	Classification
Pn139	n.□□□0 (default setting)	Disable automatic gain switching.	Immediately Tuning
	n.□□□2	Enable automatic gain switching.	

Note: Pn139 = n.□□□1 is a reserved parameter. Do not change.

Gain Switching Combinations

Selected Gains	Speed Loop Gain	Speed Loop Integral Time Constant	Position Loop Gain	Torque Reference Filter	Friction Compensation Gain
Gain Settings 1	Speed Loop Gain (Pn100)	Speed Loop Integral Time Constant (Pn101)	Position Loop Gain (Pn102)	First Stage First Torque Reference Filter Time Constant (Pn401)	Friction Compensation Gain (Pn121)
Gain Settings 2	Second Speed Loop Gain (Pn104)	Second Speed Loop Integral Time Constant (Pn105)	Second Position Loop Gain (Pn106)	First Stage Second Torque Reference Filter Time Constant (Pn412)	Second Friction Compensation Gain (Pn122)

Note: Automatic gain switching is not supported for the model following control gain and the model following control gain correction.

Switching Condition

Parameter	Switching Condition	Selected Gains	Switching Waiting Time	Switching Time
Pn139	n.□□□2	Condition A satisfied	Gain Switching Waiting Time 1 Pn135	Gain Switching Time 1 Pn131
		Condition A not satisfied	Gain Switching Waiting Time 2 Pn136	Gain Switching Time 2 Pn132

Select one of the following settings for switching condition A.

Parameter	Position Control Gain Switching Condition A	For Control Methods Other Than Position Control (No Switching)	When Enabled	Classification	
Pn139	n.□□0□ (default setting)	/COIN (Positioning Completion Output) signal turns ON.	Gain settings 1 used.	Immediately	Tuning
	n.□□1□	/COIN (Positioning Completion Output) signal turns OFF.	Gain settings 2 used.		
	n.□□2□	/NEAR (Near Output) signal turns ON.	Gain settings 1 used.		
	n.□□3□	/NEAR (Near Output) signal turns OFF.	Gain settings 2 used.		
	n.□□4□	Position reference filter output is 0 and position reference input is OFF.	Gain settings 1 used.		
	n.□□5□	Position reference input is ON.	Gain settings 2 used.		

Automatic Switching Pattern 1 (Pn139 = n.□□□2)

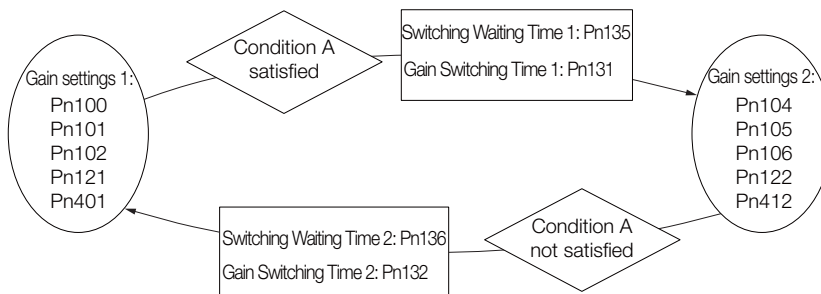

Information

/COIN (Positioning Completion Output) Signal and /NEAR (Near Output) Signal

A SERVOPACK with an INDEXER Module does not have /COIN (Positioning Completion Output) and /NEAR (Near Output) signals. Here, the following conditions are treated as the active signal status.

- /COIN (Positioning Completion Output) signal: The conditions for both Pn522 (Positioning Completed Width) and Pn207 (/COIN (Positioning Completion Output) Signal Output Timing) have been met.
- /NEAR (Near Output) signal: The current condition is equal to or less than the setting of Pn524 (Near Signal Width).

◆ Relationship between the Waiting Times and Switching Times for Gain Switching

In this example, an ON /COIN (Positioning Completion) signal is set as condition A for automatic gain switching. The position loop gain is changed from the value in Pn102 (Position Loop Gain) to the value in Pn106 (Second Position Loop Gain). When the /COIN signal turns ON, the switching operation begins after the waiting time (Pn135). The switching operation changes the position loop gain linearly from the gain set in Pn102 to the gain set in Pn106 over the switching time (Pn131).

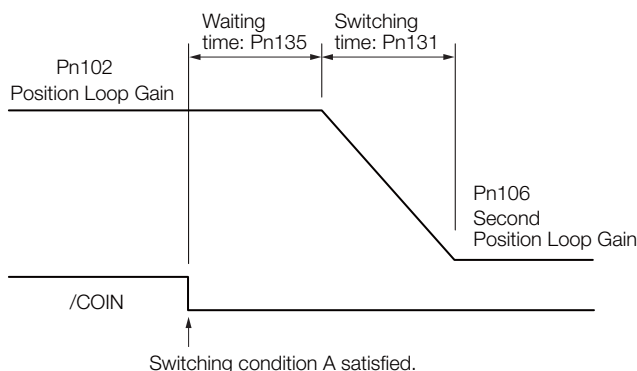

Information

You can use gain switching for either PI control or I-P control (Pn10B = n.□□□□ or □□1□).

Related Parameters

Pn100	Speed Loop Gain				
	Setting Range	Setting Unit	Default Setting	When Enabled	Classification
	10 to 20,000	0.1 Hz	400	Immediately	Tuning
Pn101	Speed Loop Integral Time Constant				
	Setting Range	Setting Unit	Default Setting	When Enabled	Classification
	15 to 51,200	0.01 ms	2,000	Immediately	Tuning
Pn102	Position Loop Gain				
	Setting Range	Setting Unit	Default Setting	When Enabled	Classification
	10 to 20,000	0.1/s	400	Immediately	Tuning
Pn401	First Stage First Torque Reference Filter Time Constant				
	Setting Range	Setting Unit	Default Setting	When Enabled	Classification
	0 to 65,535	0.01 ms	100	Immediately	Tuning
Pn121	Friction Compensation Gain				
	Setting Range	Setting Unit	Default Setting	When Enabled	Classification
	10 to 1,000	1%	100	Immediately	Tuning
Pn104	Second Speed Loop Gain				
	Setting Range	Setting Unit	Default Setting	When Enabled	Classification
	10 to 20,000	0.1 Hz	400	Immediately	Tuning
Pn105	Second Speed Loop Integral Time Constant				
	Setting Range	Setting Unit	Default Setting	When Enabled	Classification
	15 to 51,200	0.01 ms	2,000	Immediately	Tuning
Pn106	Second Position Loop Gain				
	Setting Range	Setting Unit	Default Setting	When Enabled	Classification
	10 to 20,000	0.1/s	400	Immediately	Tuning
Pn412	First Stage Second Torque Reference Filter Time Constant				
	Setting Range	Setting Unit	Default Setting	When Enabled	Classification
	0 to 65,535	0.01 ms	100	Immediately	Tuning
Pn122	Second Friction Compensation Gain				
	Setting Range	Setting Unit	Default Setting	When Enabled	Classification
	10 to 1,000	1%	100	Immediately	Tuning

Parameters Related to Automatic Gain Switching

Pn131	Gain Switching Time 1				
	Setting Range	Setting Unit	Default Setting	When Enabled	Classification
	0 to 65,535	1 ms	0	Immediately	Tuning
Pn132	Gain Switching Time 2				
	Setting Range	Setting Unit	Default Setting	When Enabled	Classification
	0 to 65,535	1 ms	0	Immediately	Tuning
Pn135	Gain Switching Waiting Time 1				
	Setting Range	Setting Unit	Default Setting	When Enabled	Classification
	0 to 65,535	1 ms	0	Immediately	Tuning
Pn136	Gain Switching Waiting Time 2				
	Setting Range	Setting Unit	Default Setting	When Enabled	Classification
	0 to 65,535	1 ms	0	Immediately	Tuning

Related Monitoring

- SigmaWin+
You can monitor gain switching with the status monitor or with tracing.
- Analog Monitors

Parameter	Analog Monitor	Monitor Name	Output Value	Description
Pn006	n.□□0B	Active Gain Monitor	1 V	Gain settings 1 are enabled.
Pn007			2 V	Gain settings 2 are enabled.

8.12.2 Friction Compensation

Friction compensation is used to compensate for viscous friction fluctuations and regular load fluctuations.

You can automatically adjust friction compensation with autotuning without a host reference, autotuning with a host reference, or custom tuning, or you can manually adjust it with the following procedure.

Required Parameter Settings

The following parameter settings are required to use friction compensation.

Parameter	Function	When Enabled	Classification
Pn408	n.0□□□ (default setting)	Immediately	Setup
	n.1□□□		
Friction Compensation Gain			
Pn121	Setting Range	Setting Unit	Default Setting
	10 to 1,000	1%	100
When Enabled			
Immediately			
Classification			
Tuning			
Second Friction Compensation Gain			
Pn122	Setting Range	Setting Unit	Default Setting
	10 to 1,000	1%	100
When Enabled			
Immediately			
Classification			
Tuning			
Friction Compensation Coefficient			
Pn123	Setting Range	Setting Unit	Default Setting
	0 to 100	1%	0
When Enabled			
Immediately			
Classification			
Tuning			
Friction Compensation Frequency Correction			
Pn124	Setting Range	Setting Unit	Default Setting
	-10,000 to 10,000	0.1 Hz	0
When Enabled			
Immediately			
Classification			
Tuning			
Friction Compensation Gain Correction			
Pn125	Setting Range	Setting Unit	Default Setting
	1 to 1,000	1%	100
When Enabled			
Immediately			
Classification			
Tuning			

Operating Procedure for Friction Compensation

Use the following procedure to perform friction compensation.

CAUTION

- Before you execute friction compensation, set the moment of inertia ratio (Pn103) as accurately as possible. If the setting greatly differs from the actual moment of inertia, vibration may occur.

8.12 Additional Adjustment Functions

8.12.2 Friction Compensation

Step	Operation
1	<p>Set the following parameters related to friction compensation to their default settings.</p> <p>Friction compensation gain (Pn121): 100 Second friction compensation gain (Pn122): 100 Friction compensation coefficient (Pn123): 0 Friction compensation frequency correction (Pn124): 0 Friction compensation gain correction (Pn125): 100</p> <p>Note: Always use the default settings for the friction compensation frequency correction (Pn124) and friction compensation gain correction (Pn125).</p>
2	<p>Gradually increase the friction compensation coefficient (Pn123) to check the effect of friction compensation.</p> <p>Note: Usually, set the friction compensation coefficient (Pn123) to 95% or less. If the effect is insufficient, increase the friction compensation gain (Pn121) by 10% increments until vibration stops.</p> <p>Effect of Adjusted Parameters</p> <p>Pn121: Friction Compensation Gain and Pn122: Second Friction Compensation Gain These parameters set the response to external disturbances. The higher the setting is, the better the response will be. If the machine has a resonance frequency, however, vibration may occur if the setting is too high.</p> <p>Pn123: Friction Compensation Coefficient This parameter sets the effect of friction compensation. The higher the setting is, the more effective friction compensation will be. If the setting is too high, however, vibration will occur more easily. Usually, set the value to 95% or less.</p>
3	<p>Effect of Adjustments</p> <p>The following graphs show the response with and without adjustment.</p>

8.12.3 Gravity Compensation

When the Servomotor is used with a vertical axis, gravity compensation prevents the moving part from falling due to the machine's own weight when the brake is released.

SERVOPACKs with software version 0023 or higher support gravity compensation.

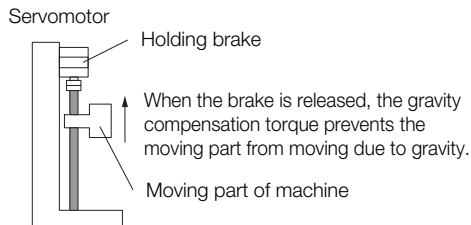

A timing chart for when the moving part is raised then lowered is provided below.

Refer to the following section for details on brake operation timing.

 5.11.1 Brake Operating Sequence on page 5-31

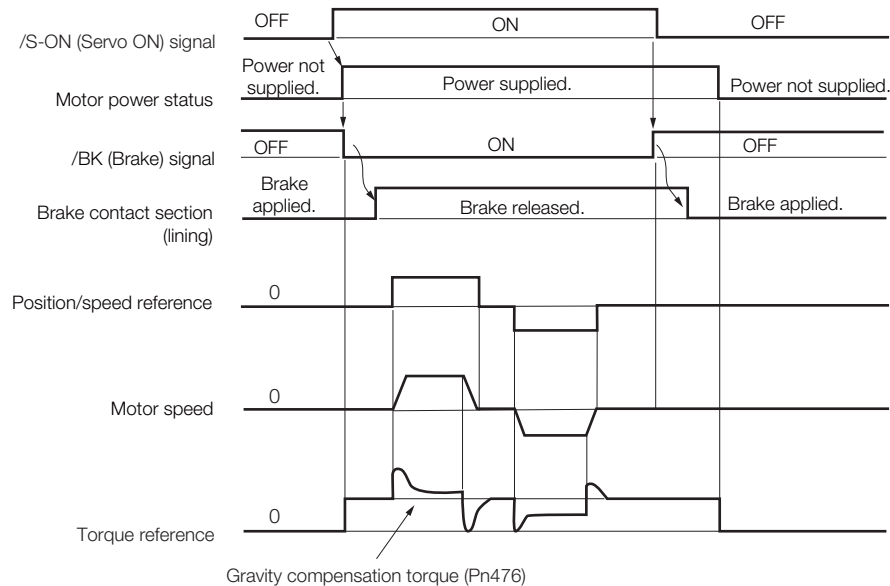

Required Parameter Settings

The following parameter settings are required to use gravity compensation.

Parameter		Description	When Enabled	Classification	
Pn475	n.□□□0 (default setting)	Disable gravity compensation.	After restart	Setup	
	n.□□□1	Enable gravity compensation.			
Gravity Compensation Torque					
Pn476	Setting Range	Setting Unit	Default Setting	When Enabled	Classification
	-1,000 to 1,000	0.1%	0	Immediately	Tuning

Operating Procedure for Gravity Compensation

Use the following procedure to perform gravity compensation.

1. Set Pn475 to n.□□□1 (Enable gravity compensation).
2. To enable changes to the settings, turn the power supply to the SERVOPACK OFF and ON again.
3. Use SigmaWin+ or an analog monitor to find the torque reference value when the motor is stopped with the servo ON.
4. Set the torque reference value found in step 3 in Pn476 (Gravity Compensation Torque).
5. Turn the servo ON and OFF a few times and fine-tune Pn476 so that the moving part of the machine does not fall.

8.12.4 Current Control Mode Selection

Current control mode selection reduces high-frequency noise while the Servomotor is being stopped.

The setting depends on the capacity of the SERVOPACK.

To use current control mode selection, use current control mode 2 (set Pn009 to n.□□1□ or n.□□2□).

- SERVOPACK Models SGD7S-R70A, -R90A, -1R6A, -2R8A, -3R8A, -5R5A, and -7R6A

Parameter	Meaning	When Enabled	Classification
Pn009	n. □□0□	After restart	Tuning
	n. □□1□ (default setting)		
	n. □□2□		

- SERVOPACK Models SGD7S-120A, -180A, -200A, -330A, -470A, -550A, -590A, and -780A

Parameter	Meaning	When Enabled	Classification
Pn009	n. □□0□	After restart	Tuning
	n. □□1□ (default setting)		
	n. □□2□		



If current control mode 2 is selected, the load ratio may increase while the Servomotor is being stopped.

Important

8.12.5 Current Gain Level Setting

You can set the current gain level to reduce noise by adjusting the parameter for current control inside the SERVOPACK according to the speed loop gain (Pn100). The noise level can be reduced by decreasing the current gain level (Pn13D) from its default setting of 2,000% (disabled). However, if the setting is decreased, the level of noise will be lowered, but the response characteristic of the SERVOPACK will also be reduced. Adjust the current gain level within the range that maintains the SERVOPACK response characteristic.

Pn13D	Current Gain Level				
	Setting Range	Setting Unit	Default Setting	When Enabled	Classification
	100 to 2,000	1%	2,000	Immediately	Tuning



If the current gain level is changed, the response characteristic of the speed loop will also change. Servo tuning must therefore be performed again.

8.12.6 Speed Detection Method Selection

You can use the speed detection method selection to ensure smooth Servomotor speed changes during operation. To ensure smooth motor speed changes during operation, set Pn009 to n.□1□□ (Use speed detection 2).

With a Linear Servomotor, you can reduce the noise level of the running motor when the linear encoder scale pitch is large.

Parameter	Meaning	When Enabled	Classification
Pn009	n. □0□□ (default setting)	After restart	Tuning
	n. □1□□		



If the speed detection method is changed, the response characteristic of the speed loop will also change. Servo tuning must therefore be performed again.

8.12.7 Speed Feedback Filter

You can set a first order lag filter for the speed feedback in the speed loop. This ensures smooth changes in the feedback speed to reduce vibration. If a large value is set, it will increase the delay and make response slower.

Pn308	Speed Feedback Filter Time Constant				
	Setting Range	Setting Unit	Default Setting	When Enabled	Classification
	0 to 65,535 (0.00 ms to 655.35 ms)	0.01 ms	0 (0.00 ms)	Immediately	Setup

8.12.8 Backlash Compensation

Outline

If you drive a machine that has backlash, there will be deviation between the travel distance in the position reference that is managed by the host controller and the travel distance of the actual machine. Use backlash compensation to add the backlash compensation value to the position reference and use the result to drive the Servomotor. This will ensure that the travel distance of the actual machine will be the same as the travel distance in the host controller.

Note: Backlash compensation can be used only with a Rotary Servomotor.

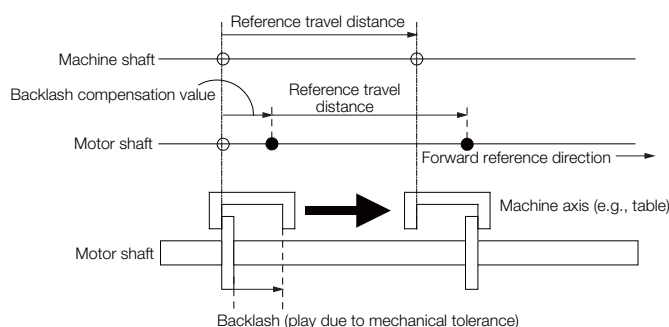

This parameter can be set to compensate for positioning offset caused by the backlash of gears.

PnB50	Backlash Compensation			
	Setting Range	Setting Unit	Default Setting	When Enabled
	-1000 to 1000	1 reference unit	0	Immediately

Specify the direction for compensation with the sign and the quantity of the compensation with a numeric value. If the sign is positive, compensation will be applied for forward positioning. If the sign is negative, compensation will be applied for reverse positioning. If the setting is changed, the new setting will be enabled from the next positioning.

When using an incremental encoder, the final direction used in homing generally serves as the reference direction and backlash compensation is applied in the opposite direction.

When using an absolute encoder, the initial direction of movement generally serves as the reference direction and backlash compensation is applied in the opposite direction.

Even when compensation is applied, the compensation will not be indicated in the target position monitor or any other monitor values. Only the actual motor positions will be subject to compensation.

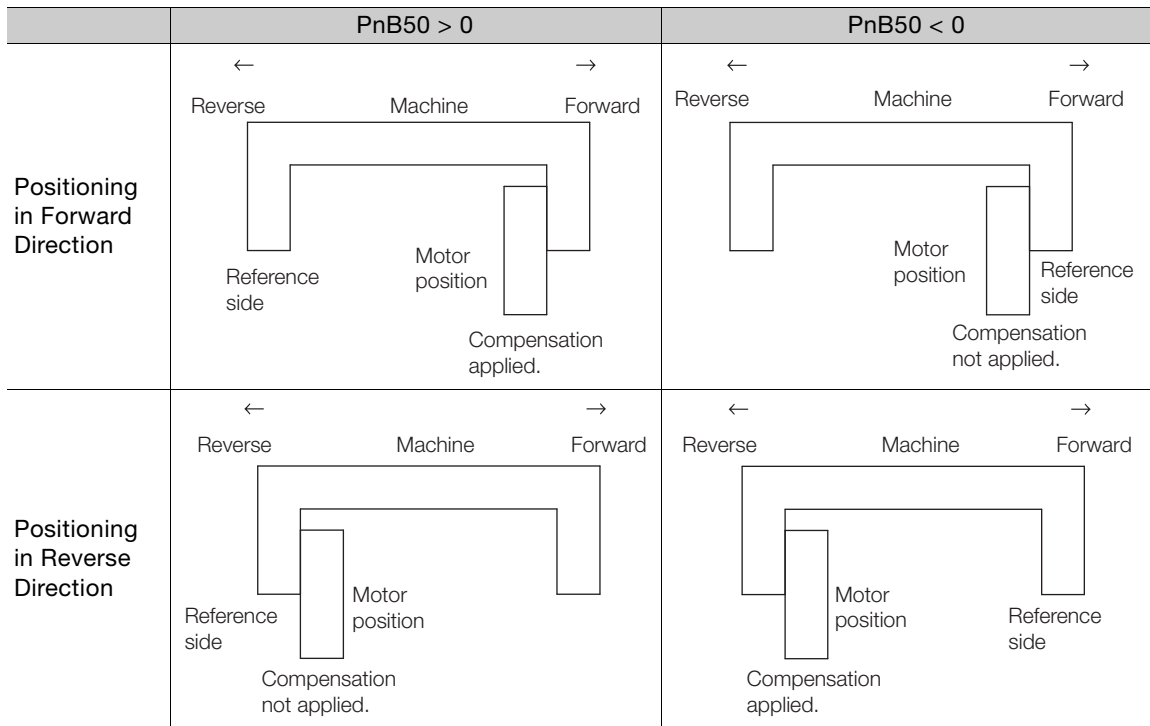

8.13 Manual Tuning

This section describes manual tuning.

8.13.1 Tuning the Servo Gains

Servo Gains

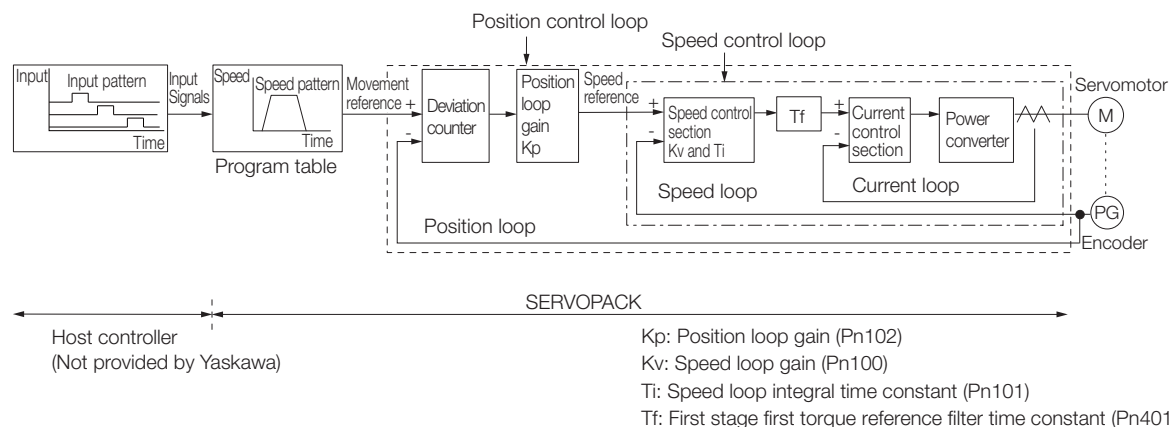

In order to manually tune the servo gains, you must understand the configuration and characteristic of the SERVOPACK and adjust the servo gains individually. In most cases, if you greatly change any one parameter, you must adjust the other parameters again. To check the response characteristic, you must prepare a measuring instrument to monitor the output waveforms from the analog monitor.

The SERVOPACK has three feedback systems (the position loop, speed loop, and current loop), and the response characteristic must be increased more with the inner loops. If this relationship is not maintained, the response characteristic will suffer and vibration will occur more easily.

A sufficient response characteristic is ensured for the current loop. There is never a need for it to be adjusted by the user.

Outline

You can use manual tuning to set the servo gains in the SERVOPACK to increase the response characteristic of the SERVOPACK and to reduce the positioning time.

Use manual tuning in the following cases.

- When tuning with autotuning without a host reference or autotuning with a host reference does not achieve the desired results
- When you want to increase the servo gains higher than the gains that resulted from autotuning without a host reference or autotuning with a host reference
- When you want to determine the servo gains and moment of inertia ratio yourself

You start manual tuning either from the default parameter settings or from the gain settings that resulted from autotuning without a host reference or autotuning with a host reference.

Applicable Tools

You can monitor the servo gains with the SigmaWin+ or with the analog monitor.

Precautions

Vibration may occur while you are tuning the servo gains. We recommend that you enable vibration alarms (Pn310 = n.□□□2) to detect vibration. Refer to the following section for information on vibration detection.

 6.10 *Initializing the Vibration Detection Level* on page 6-32

Vibration alarms are not detected for all vibration. Also, an emergency stop method is necessary to stop the machine safely when an alarm occurs. You must provide an emergency stop device and activate it immediately whenever vibration occurs.

Tuning Procedure Example

Step	Description
1	Adjust the first stage first torque reference filter time constant (Pn401) so that vibration does not occur.
2	Increase the position loop gain (Pn100) and reduce the speed loop integral time constant (Pn101) as far as possible within the range that does not cause machine vibration.
3	Repeat steps 1 and 2 and return the settings about 10% to 20% from the values that you set.
4	Increase the position loop gain (Pn102) within the range that does not cause vibration.

Information

If you greatly change any one servo gain parameter, you must adjust the other parameters again. Do not increase the setting of just one parameter. As a guideline, adjust the settings of the servo gains by approximately 5% each. As a rule, change the servo parameters in the following order.

- To Increase the Response Speed
 1. Reduce the torque reference filter time constant.
 2. Increase the speed loop gain.
 3. Decrease the speed loop integral time constant.
 4. Increase the position loop gain.
- To Reduce Response Speed and to Stop Vibration and Overshooting
 1. Reduce the position loop gain.
 2. Increase the speed loop integral time constant.
 3. Decrease the speed loop gain.
 4. Increase the torque filter time constant.

Adjusted Servo Gains

You can set the following gains to adjust the response characteristic of the SERVOPACK.

- Pn100: Speed Loop Gain
- Pn101: Speed Loop Integral Time Constant
- Pn102: Position Loop Gain
- Pn401: First Stage First Torque Reference Filter Time Constant

◆ Position Loop Gain

The position loop gain determines the response characteristic of the position loop in the SERVOPACK. If you can increase the setting of the position loop gain, the response characteristic will improve and the positioning time will be shortened. However, you normally cannot increase the position loop gain higher than the inherit vibration frequency of the machine system. Therefore, to increase the setting of the position loop gain, you must increase the rigidity of the machine to increase the inherit vibration frequency of the machine.

Pn102	Position Loop Gain				
	Setting Range	Setting Unit	Default Setting	When Enabled	Classification
	10 to 20,000	0.1/s	400	Immediately	Tuning

Information

For machines for which a high position loop gain (Pn102) cannot be set, overflow alarms can occur during high-speed operation. If that is the case, you can increase the setting of the following parameter to increase the level for alarm detection. Use the following condition as a guideline for determining the setting.

$$Pn520 \geq \frac{\text{Maximum feed speed [reference units/s]}}{Pn102 \div 10 (1/s)} \times 2.0$$

If you use a position reference filter, transient deviation will increase due to the filter time constant. When you make the setting, consider deviation accumulation that may result from the filter.

Pn520	Position Deviation Overflow Alarm Level				
	Setting Range	Setting Unit	Default Setting	When Enabled	Classification
	1 to 1,073,741,823	1 reference unit	5,242,880	Immediately	Setup

◆ Speed Loop Gain

This parameter determines the response characteristic of the speed loop. If the response characteristic of the speed loop is low, it becomes a delay factor for the position loop located outside of the speed loop. This will result in overshooting and vibration in the speed reference. Therefore, setting the speed loop gain as high as possible within the range that will not cause the machine system to vibrate will produce a stable servo system with a good response characteristic.

Pn100	Speed Loop Gain				
	Setting Range	Setting Unit	Default Setting	When Enabled	Classification
	10 to 20,000	0.1 Hz	400	Immediately	Tuning

$$\text{Setting of Pn103} = \frac{\text{Load moment of inertia at motor shaft } (J_L)}{\text{Servomotor moment of inertia } (L_M)} \times 100(\%)$$

The default setting of Pn103 (Moment of Inertia Ratio) is 100. Before you tune the servo, calculate the moment of inertia ratio with the above formula and set Pn103 to the calculation result.

Pn103	Moment of Inertia Ratio				
	Setting Range	Setting Unit	Default Setting	When Enabled	Classification
	0 to 20,000	1%	100	Immediately	Tuning

◆ Speed Loop Integral Time Constant

To enable response to even small inputs, the speed loop has an integral element. The integral element becomes a delay factor in the servo system. If the time constant is set too high, overshooting will occur, positioning settling time will increase, and the response characteristic will suffer.

Pn101	Speed Loop Integral Time Constant				
	Setting Range	Setting Unit	Default Setting	When Enabled	Classification
	15 to 51,200	0.01 ms	2,000	Immediately	Tuning

◆ Torque Reference Filter

As shown in the following diagram, the torque reference filter contains a first order lag filter and notch filters arranged in series, and each filter operates independently.

The notch filters can be enabled and disabled with Pn408 = n.□X□X and Pn416 = n.□XXX.

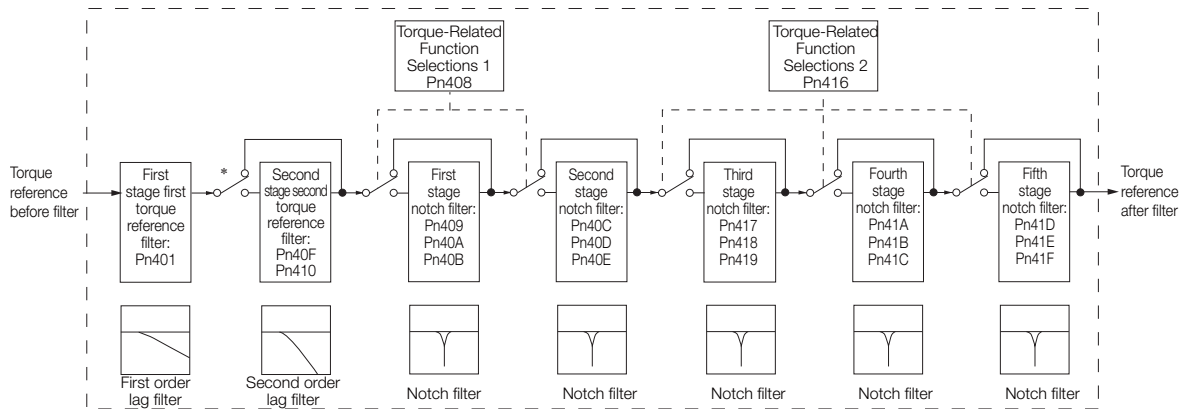

* The second stage second torque reference filter is disabled when Pn40F is set to 5,000 (default setting) and it is enabled when Pn40F is set to a value lower than 5,000.

■ Torque Reference Filter

If you suspect that machine vibration is being caused by the Servo Drive, try adjusting the torque reference filter time constant. This may stop the vibration. The lower the value, the better the control response characteristic will be, but there may be a limit depending on the machine conditions.

Pn401	First Stage First Torque Reference Filter Time Constant				
	Setting Range	Setting Unit	Default Setting	When Enabled	Classification
	0 to 65,535	0.01 ms	100	Immediately	Tuning
Pn40F	Second Stage Second Torque Reference Filter Frequency				
	Setting Range	Setting Unit	Default Setting	When Enabled	Classification
	100 to 5,000	1 Hz	5,000*	Immediately	Tuning
Pn410	Second Stage Second Torque Reference Filter Q Value				
	Setting Range	Setting Unit	Default Setting	When Enabled	Classification
	50 to 100	0.01	50	Immediately	Tuning

* The filter is disabled if you set the parameter to 5,000.

■ Notch Filters

The notch filter can eliminate specific frequency elements generated by the vibration of sources such as resonance of the shaft of a ball screw.

The notch filter puts a notch in the gain curve at the specific vibration frequency (called the notch frequency). The frequency components near the notch frequency can be reduced or removed with a notch filter.

Notch filters are set with three parameters for the notch filter frequency, notch filter Q value, and notch filter depth. This section describes the notch filter Q value and notch filter depth.

• Notch filter Q Value

The setting of the notch filter Q value determines the width of the frequencies that are filtered for the notch filter frequency. The width of the notch changes with the notch filter Q value. The larger the notch filter Q value is, the steeper the notch is and the narrower the width of frequencies that are filtered is.

The notch filter frequency characteristics for different notch filter Q values are shown below.

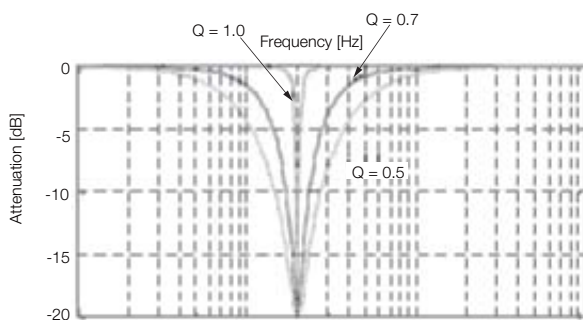

Note: The above notch filter frequency characteristics are based on calculated values and may be different from actual characteristics.

• Notch Filter Depth

The setting of the notch filter depth determines the depth of the frequencies that are filtered for the notch filter frequency. The depth of the notch changes with the notch filter depth. The smaller the notch filter depth is, the deeper the notch is, increasing the effect of vibration suppression. However, if the value is too small, vibration can actually increase.

The notch filter is disabled if the notch filter depth, d, is set to 1.0 (i.e., if Pn419 is set to 1,000).

The notch filter frequency characteristics for different notch filter depths are shown below.

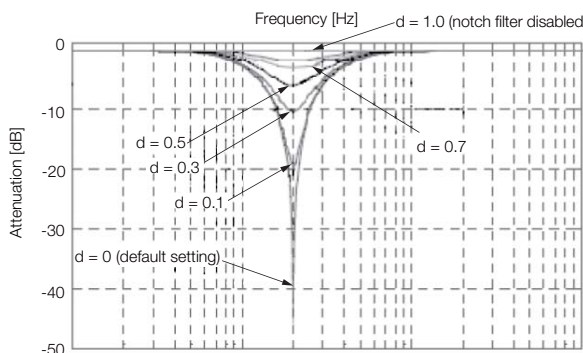

Note: The above notch filter frequency characteristics are based on calculated values and may be different from actual characteristics.

You can enable or disable the notch filter with Pn408 and Pn416.

Parameter	Meaning	When Enabled	Classification	
Pn408	n.□□□0 (default setting)	Disable first stage notch filter.	Immediately	Setup
	n.□□□1	Enable first stage notch filter.		
	n.□0□□ (default setting)	Disable second stage notch filter.		
	n.□1□□	Enable second stage notch filter.		
Pn416	n.□□□0 (default setting)	Disable third stage notch filter.		
	n.□□□1	Enable third stage notch filter.		
	n.□□0□ (default setting)	Disable fourth stage notch filter.		
	n.□□1□	Enable fourth stage notch filter.		
	n.□0□□ (default setting)	Disable fifth stage notch filter.		
	n.□1□□	Enable fifth stage notch filter.		

Set the machine vibration frequencies in the notch filter parameters.

8.13 Manual Tuning

8.13.1 Tuning the Servo Gains

Pn409	First Stage Notch Filter Frequency				
	Setting Range	Setting Unit	Default Setting	When Enabled	Classification
	50 to 5,000	1 Hz	5,000	Immediately	Tuning
Pn40A	First Stage Notch Filter Q Value				
	Setting Range	Setting Unit	Default Setting	When Enabled	Classification
	50 to 1,000	0.01	70	Immediately	Tuning
Pn40B	First Stage Notch Filter Depth				
	Setting Range	Setting Unit	Default Setting	When Enabled	Classification
	0 to 1,000	0.001	0	Immediately	Tuning
Pn40C	Second Stage Notch Filter Frequency				
	Setting Range	Setting Unit	Default Setting	When Enabled	Classification
	50 to 5,000	1 Hz	5,000	Immediately	Tuning
Pn40D	Second Stage Notch Filter Q Value				
	Setting Range	Setting Unit	Default Setting	When Enabled	Classification
	50 to 1,000	0.01	70	Immediately	Tuning
Pn40E	Second Stage Notch Filter Depth				
	Setting Range	Setting Unit	Default Setting	When Enabled	Classification
	0 to 1,000	0.001	0	Immediately	Tuning
Pn417	Third Stage Notch Filter Frequency				
	Setting Range	Setting Unit	Default Setting	When Enabled	Classification
	50 to 5,000	1 Hz	5,000	Immediately	Tuning
Pn418	Third Stage Notch Filter Q Value				
	Setting Range	Setting Unit	Default Setting	When Enabled	Classification
	50 to 1,000	0.01	70	Immediately	Tuning
Pn419	Third Stage Notch Filter Depth				
	Setting Range	Setting Unit	Default Setting	When Enabled	Classification
	0 to 1,000	0.001	0	Immediately	Tuning
Pn41A	Fourth Stage Notch Filter Frequency				
	Setting Range	Setting Unit	Default Setting	When Enabled	Classification
	50 to 5,000	1 Hz	5,000	Immediately	Tuning
Pn41B	Fourth Stage Notch Filter Q Value				
	Setting Range	Setting Unit	Default Setting	When Enabled	Classification
	50 to 1,000	0.01	70	Immediately	Tuning
Pn41C	Fourth Stage Notch Filter Depth				
	Setting Range	Setting Unit	Default Setting	When Enabled	Classification
	0 to 1,000	0.001	0	Immediately	Tuning
Pn41D	Fifth Stage Notch Filter Frequency				
	Setting Range	Setting Unit	Default Setting	When Enabled	Classification
	50 to 5,000	1 Hz	5,000	Immediately	Tuning
Pn41E	Fifth Stage Notch Filter Q Value				
	Setting Range	Setting Unit	Default Setting	When Enabled	Classification
	50 to 1,000	0.01	70	Immediately	Tuning
Pn41F	Fifth Stage Notch Filter Depth				
	Setting Range	Setting Unit	Default Setting	When Enabled	Classification
	0 to 1,000	0.001	0	Immediately	Tuning



Important

- Do not set notch filter frequencies (Pn409, Pn40C, Pn417, Pn41A, and Pn41D) that are close to the speed loop's response frequency. Set a frequency that is at least four times the speed loop gain (Pn100). (However, Pn103 (Moment of Inertia Ratio) must be set correctly. If the setting is not correct, vibration may occur and the machine may be damaged.
- Change the notch filter frequencies (Pn409, Pn40C, Pn417, Pn41A, and Pn41D) only while the Servomotor is stopped. Vibration may occur if a notch filter frequency is changed during operation.

Guidelines for Manually Tuning Servo Gains

When you manually adjust the parameters, make sure that you completely understand the information in the product manual and use the following conditional expressions as guidelines. The appropriate values of the parameter settings are influenced by the machine specifications, so they cannot be determined universally. When you adjust the parameters, actually operate the machine and use the SigmaWin+ or analog monitor to monitor operating conditions. Even if the status is stable while the Servomotor is stopped, an unstable condition may occur when an operation reference is input. Therefore, input operation references and adjust the servo gains as you operate the Servomotor.

Stable gain: Settings that provide a good balance between parameters.

However, if the load moment of inertia is large and the machine system contains elements prone to vibration, you must sometimes use a setting that is somewhat higher to prevent the machine from vibrating.

Critical gain: Settings for which the parameters affect each other

Depending on the machine conditions, overshooting and vibration may occur and operation may not be stable. If the critical gain condition expressions are not met, operation will become more unstable, and there is a risk of abnormal motor shaft vibration and round-trip operation with a large amplitude. Always stay within the critical gain conditions.

If you use the torque reference filter, second torque reference filter, and notch filters together, the interference between the filters and the speed loop gain will be superimposed. Allow leeway in the adjustments.



Important

The following adjusted value guidelines require that the setting of Pn103 (Moment of Inertia Ratio) is correctly set for the actual machine.

◆ When Pn10B = n.□□0□ (PI Control)

Guidelines are given below for gain settings 1.

The same guidelines apply to gain settings 2 (Pn104, Pn105, Pn106, and Pn412).

- Speed Loop Gain (Pn100 [Hz]) and Position Loop Gain (Pn102 [/s])
 - Stable gain: $Pn102 [s] \leq 2\pi \times Pn100/4 [Hz]$
 - Critical gain: $Pn102 [s] < 2\pi \times Pn100 [Hz]$
- Speed Loop Gain (Pn100 [Hz]) and Speed Loop Integral Time Constant (Pn101 [ms])
 - Stable gain: $Pn101 [ms] \geq 4,000/(2\pi \times Pn100 [Hz])$
 - Critical gain: $Pn101 [ms] > 1,000/(2\pi \times Pn100 [Hz])$
- Speed Loop Gain (Pn100 [Hz]) and First Stage First Torque Reference Filter Time Constant (Pn401 [ms])
 - Stable gain: $Pn401 [ms] \leq 1,000/(2\pi \times Pn100 [Hz] \times 4)$
 - Critical gain: $Pn401 [ms] < 1,000/(2\pi \times Pn100 [Hz] \times 1)$

8.13.1 Tuning the Servo Gains

- Speed Loop Gain (Pn100 [Hz]) and Second Stage Second Torque Reference Filter Frequency (Pn40F [Hz])
 Critical gain: $Pn40F [Hz] > 4 \times Pn100 [Hz]$
 Note: Set the second stage second torque reference filter Q value (Pn410) to 0.70.
- Speed Loop Gain (Pn100 [Hz]) and First Stage Notch Filter Frequency (Pn409 [Hz]) (or Second Stage Notch Filter Frequency (Pn40C [Hz]))
 Critical gain: $Pn409 [Hz] > 4 \times Pn100 [Hz]$
- Speed Loop Gain (Pn100 [Hz]) and Speed Feedback Filter Time Constant (Pn308 [ms])
 Stable gain: $Pn308 [ms] \leq 1,000 / (2\pi \times Pn100 [Hz] \times 4)$
 Critical gain: $Pn308 [ms] < 1,000 / (2\pi \times Pn100 [Hz] \times 1)$

◆ When Pn10B = n.□□1□ (I-P Control)

Guidelines are given below for gain settings 1.

The same guidelines apply to gain settings 2 (Pn104, Pn105, Pn106, and Pn412).

For I-P control, the relationships between the speed loop integral time constant, speed loop gain, and position loop gain are different from the relationships for PI control. The relationship between other servo gains is the same as for PI control.

- Speed Loop Gain (Pn100 [Hz]) and Speed Loop Integral Time Constant (Pn101 [ms])
 Stable gain: $Pn100 [Hz] \geq 320 / Pn101 [ms]$
- Position Loop Gain (Pn102 [/s]) and Speed Loop Integral Time Constant (Pn101 [ms])
 Stable gain: $Pn102 [/s] \leq 320 / Pn101 [ms]$

Information

Selecting the Speed Loop Control Method (PI Control or I-P Control)

Usually, I-P control is effective for high-speed positioning and high-speed, high-precision processing applications. With I-P control, you can use a lower position loop gain than for PI control to reduce the positioning time and reduce arc radius reduction. However, if you can use mode switching to change to proportional control to achieve the desired application, then using PI control would be the normal choice.

◆ Decimal Points in Parameter Settings

For the SGD7S SERVOPACKs, decimal places are given for the settings of parameters on the Digital Operator and in the manual. For example with Pn100 (Speed Loop Gain), Pn100 = 40.0 is used to indicate a setting of 40.0 Hz. In the following adjusted value guidelines, the decimal places are also given.

Example

- Speed Loop Gain (Pn100 [Hz]) and Speed Loop Integral Time Constant (Pn101 [ms])
 Stable gain: $Pn101 [ms] \geq 4,000 / (2\pi \times Pn100 [Hz])$, therefore
 If $Pn100 = 40.0 [Hz]$, then $Pn101 = 4,000 / (2\pi \times 40.0) \approx 15.92 [ms]$.

Model Following Control

You can use model following control to improve response characteristic and shorten positioning time. You can use model following control only with position control.

Normally, the parameters that are used for model following control are automatically set along with the servo gains by executing autotuning or custom tuning. However, you must adjust them manually in the following cases.

- When the tuning results for autotuning or custom tuning are not acceptable
- When you want to increase the response characteristic higher than that achieved by the tuning results for autotuning or custom tuning
- When you want to determine the servo gains and model following control parameters yourself

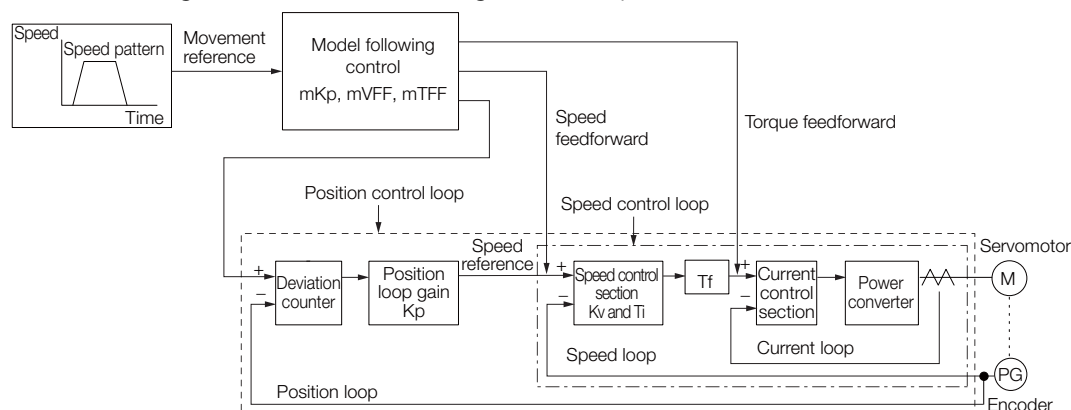

The block diagram for model following control is provided below.



Kp: Position loop gain (Pn102)
 Kv: Speed loop gain (Pn100)
 Ti: Speed loop integral time constant (Pn101)
 Tf: First stage first torque reference filter time constant (Pn401)
 mKp: Model following control gain (Pn141)
 mTFF: Model following control bias in the forward direction (Pn143)
 Model following control bias in the reverse direction (Pn144)
 mVFF: Model following control speed feedforward compensation (Pn147)

◆ Manual Tuning Procedure

Use the following tuning procedure for using model following control.

Step	Description
1	Friction compensation must also be used. Set the friction compensation parameters. Refer to the following section for the setting procedure.  8.12.2 Friction Compensation on page 8-67
2	Adjust the servo gains. Refer to the following section for an example procedure.  Tuning Procedure Example on page 8-74 Note: 1. Set the moment of inertia ratio (Pn103) as accurately as possible. 2. Refer to the guidelines for manually tuning the servo gains and set a stable gain for the position loop gain (Pn102).  Guidelines for Manually Tuning Servo Gains on page 8-79
3	Increase the model following control gain (Pn141) as much as possible within the range in which overshooting and vibration do not occur.
4	If overshooting occurs or if the response is different for forward and reverse operation, fine-tune model following control with the following settings: model following control bias in the forward direction (Pn143), model following control bias in the reverse direction (Pn144), and model following control speed feedforward compensation (Pn147).

◆ **Related Parameters**

Next we will describe the following parameters that are used for model following control.

- Pn140 (Model Following Control-Related Selections)
- Pn141 (Model Following Control Gain)
- Pn143 (Model Following Control Bias in the Forward Direction)
- Pn144 (Model Following Control Bias in the Reverse Direction)
- Pn147 (Model Following Control Speed Feedforward Compensation)

■ **Model Following Control-Related Selections**

Set Pn140 = n.□□□X to specify whether to use model following control.

If you use model following control with vibration suppression, set Pn140 to n.□□1□ or Pn140 = n.□□2□. When you also perform vibration suppression, adjust vibration suppression with custom tuning in advance.

Note: If you use vibration suppression (Pn140 = n.□□1□ or Pn140 = n.□□2□), always set Pn140 to n.□□□1 (Use model following control).

Parameter	Function	When Enabled	Classification
Pn140	n.□□□0 (default setting)	Immediately	Tuning
	n.□□□1		
	n.□□0□ (default setting)		
	n.□□1□		
	n.□□2□		

■ **Model Following Control Gain**

The model following control gain determines the response characteristic of the servo system. If you increase the setting of the model following control gain, the response characteristic will improve and the positioning time will be shortened. The response characteristic of the servo system is determined by this parameter, and not by Pn102 (Position Loop Gain).

Pn141	Model Following Control Gain				
	Setting Range	Setting Unit	Default Setting	When Enabled	Classification
	10 to 20,000	0.1/s	500	Immediately	Tuning

Information

For machines for which a high model following control gain cannot be set, the size of the position deviation in model following control will be determined by the setting of the model following control gain. For a machine with low rigidity, in which a high model following control gain cannot be set, position deviation overflow alarms may occur during high-speed operation. If that is the case, you can increase the setting of the following parameter to increase the level for alarm detection.

Use the following conditional expression for reference in determining the setting.

$$Pn\ 520 \geq \frac{\text{Maximum feed speed [reference units/s]}}{Pn\ 141/10 [1/s]} \times 2.0$$

Pn520	Position Deviation Overflow Alarm Level				
	Setting Range	Setting Unit	Default Setting	When Enabled	Classification
	1 to 1,073,741,823	1 reference unit	5,242,880	Immediately	Setup

■ Model Following Control Bias in the Forward Direction and Model Following Control Bias in the Reverse Direction

If the response is different for forward and reverse operation, use the following parameters for fine-tuning.

If you decrease the settings, the response characteristic will be lowered but overshooting will be less likely to occur.

Model Following Control Bias in the Forward Direction					
Pn143	Setting Range	Setting Unit	Default Setting	When Enabled	Classification
		0 to 10,000	0.1%	1,000	Immediately
Model Following Control Bias in the Reverse Direction					
Pn144	Setting Range	Setting Unit	Default Setting	When Enabled	Classification
		0 to 10,000	0.1%	1,000	Immediately

■ Model Following Control Speed Feedforward Compensation

If overshooting occurs even after you adjust the model following control gain, model following control bias in the forward direction, and model following control bias in the reverse direction, you may be able to improve performance by setting the following parameter.

If you decrease the settings, the response characteristic will be lowered but overshooting will be less likely to occur.

Model Following Control Speed Feedforward Compensation					
Pn147	Setting Range	Setting Unit	Default Setting	When Enabled	Classification
		0 to 10,000	0.1%	1,000	Immediately

■ Model Following Control Type Selection

When you enable model following control, you can select the model following control type. Normally, set Pn14F to n.□□□1 (Use model following control type 2) (default setting). If compatibility with previous models is required, set Pn14F to n.□□□0 (Use model following control type 1).

Parameter		Meaning	When Enabled	Classification
Pn14F	n.□□□0	Use model following control type 1.	After restart	Tuning
	n.□□□1 (default setting)	Use model following control type 2.		

8.13.2 Compatible Adjustment Functions

The compatible adjustment functions are used together with manual tuning. You can use these functions to improve adjustment results. These functions allow you to use the same functions as for Σ -III-Series SERVOPACKs to adjust Σ -7-Series SERVOPACKs.

Feedforward

The feedforward function applies feedforward compensation to position control to shorten the positioning time.

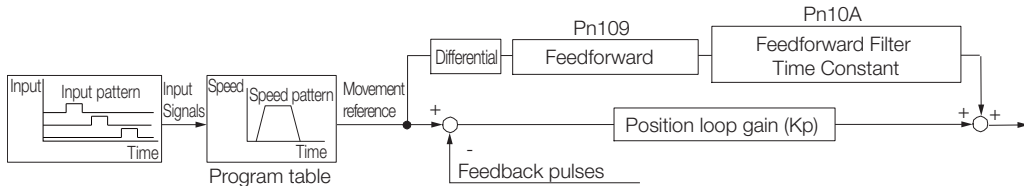

Pn109	Feedforward				
	Setting Range	Setting Unit	Default Setting	When Enabled	Classification
	0 to 100	1%	0	Immediately	Tuning
Pn10A	Feedforward Filter Time Constant				
	Setting Range	Setting Unit	Default Setting	When Enabled	Classification
	0 to 6,400	0.01 ms	0	Immediately	Tuning

Note: If you set the feedforward value too high, the machine may vibrate. As a guideline, use a setting of 80% or less.

Mode Switching (Changing between Proportional and PI Control)

You can use mode switching to automatically change between proportional control and PI control.

Overshooting caused by acceleration and deceleration can be suppressed and the settling time can be reduced by setting the switching condition and switching levels.

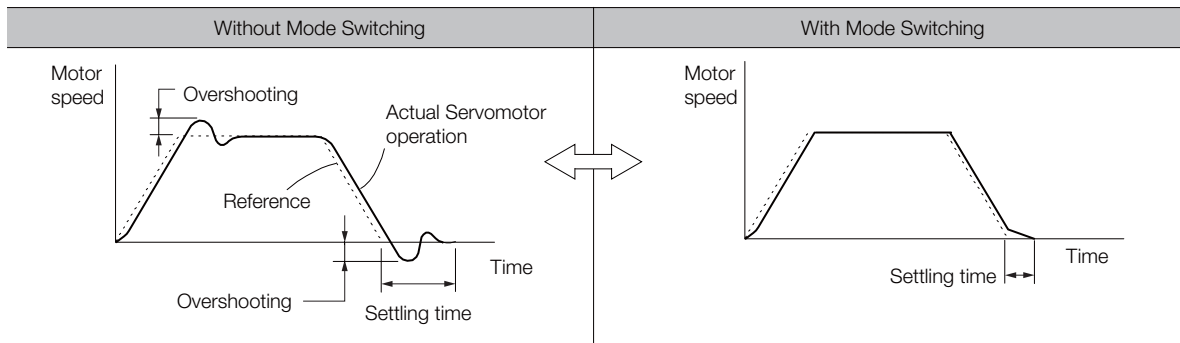

◆ Related Parameters

Select the switching condition for mode switching with Pn10B = n.□□□X.

Parameter	Mode Switching Selection	Parameter That Sets the Level		When Enabled	Classification	
		Rotary Servomotor	Linear Servomotor			
Pn10B	n.□□□0 (default setting)	Use the internal torque reference as the condition.	Pn10C		Immediately	Setup
	n.□□□1	Use the speed reference as the condition.	Pn10D	Pn181		
	n.□□□2	Use the acceleration reference as the condition.	Pn10E	Pn182		
	n.□□□3	Use the position deviation as the condition.	Pn10F			
	n.□□□4	Do not use mode switching.	-			

■ Parameters That Set the Switching Levels

• Rotary Servomotors

Pn10C	Mode Switching Level for Torque Reference				
	Setting Range	Setting Unit	Default Setting	When Enabled	Classification
	0 to 800	1%	200	Immediately	Tuning
Pn10D	Mode Switching Level for Speed Reference				
	Setting Range	Setting Unit	Default Setting	When Enabled	Classification
	0 to 10,000	1 min ⁻¹	0	Immediately	Tuning
Pn10E	Mode Switching Level for Acceleration				
	Setting Range	Setting Unit	Default Setting	When Enabled	Classification
	0 to 30,000	1 min ⁻¹ /s	0	Immediately	Tuning
Pn10F	Mode Switching Level for Position Deviation				
	Setting Range	Setting Unit	Default Setting	When Enabled	Classification
	0 to 10,000	1 reference unit	0	Immediately	Tuning

• Linear Servomotors

Pn10C	Mode Switching Level for Force Reference				
	Setting Range	Setting Unit	Default Setting	When Enabled	Classification
	0 to 800	1%	200	Immediately	Tuning
Pn181	Mode Switching Level for Speed Reference				
	Setting Range	Setting Unit	Default Setting	When Enabled	Classification
	0 to 10,000	1 mm/s	0	Immediately	Tuning
Pn182	Mode Switching Level for Acceleration				
	Setting Range	Setting Unit	Default Setting	When Enabled	Classification
	0 to 30,000	1 mm/s ²	0	Immediately	Tuning
Pn10F	Mode Switching Level for Position Deviation				
	Setting Range	Setting Unit	Default Setting	When Enabled	Classification
	0 to 10,000	1 reference unit	0	Immediately	Tuning

■ Using the Internal Torque Reference as the Mode Switching Condition (Default Setting)

When the internal torque reference equals or exceeds the torque set for the mode switching level for torque reference (Pn10C), the speed loop is changed to P control.

The default setting for the torque reference level is 200%.

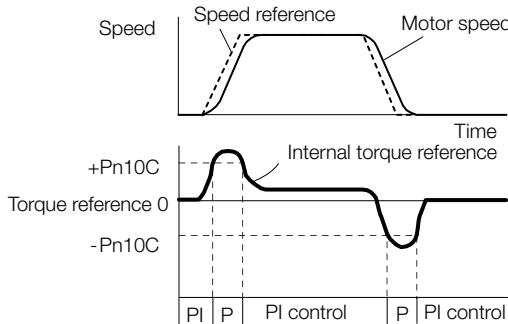

■ Using the Speed Reference as the Mode Switching Condition

• Rotary Servomotors

When the speed reference equals or exceeds the speed set for the mode switching level for a speed reference (Pn10D), the speed loop is changed to P control.

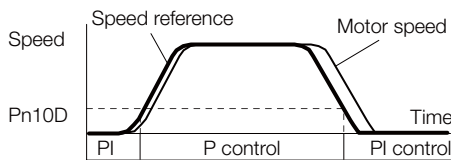

• Linear Servomotors

When the speed reference equals or exceeds the speed set for the mode switching level for a speed reference (Pn181), the speed loop is changed to P control.

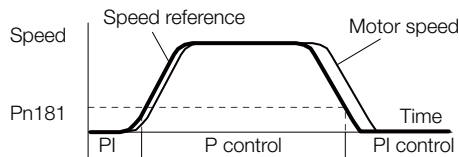

■ Using the Acceleration as the Mode Switching Condition

• Rotary Servomotors

When the speed reference equals or exceeds the acceleration rate set for the mode switching level for acceleration (Pn10E), the speed loop is changed to P control.

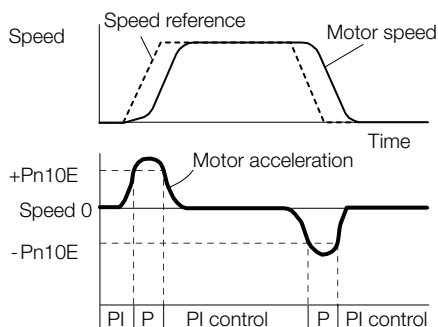

• Linear Servomotors

When the speed reference equals or exceeds the acceleration rate set for the mode switching level for acceleration (Pn182), the speed loop is changed to P control.

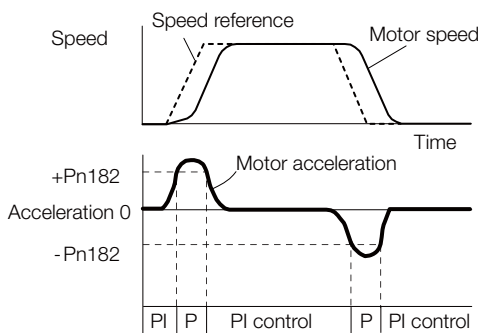

■ Using the Position Deviation as the Mode Switching Condition

When the position deviation equals or exceeds the value set for the mode switching level for position deviation (Pn10F), the speed loop is changed to P control.

This setting is enabled only for position control.

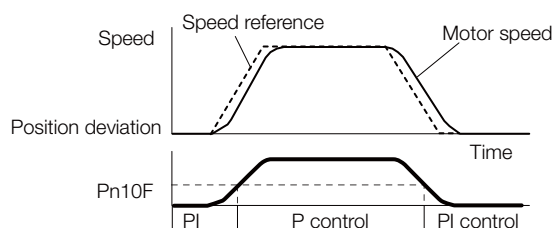

Position Integral

The position integral is the integral function of the position loop. It is used for the electronic cams and electronic shafts when using the SERVOPACK with a Yaskawa MP3000-Series Machine Controller.

Pn11F	Position Integral Time Constant				
	Setting Range	Setting Unit	Default Setting	When Enabled	Classification
	0 to 50,000	0.1 ms	0	Immediately	Tuning

8.14 Diagnostic Tools

8.14.1 Mechanical Analysis

Overview

You can connect the SERVOPACK to a computer to measure the frequency characteristics of the machine. This allows you to measure the frequency characteristics of the machine without using a measuring instrument.

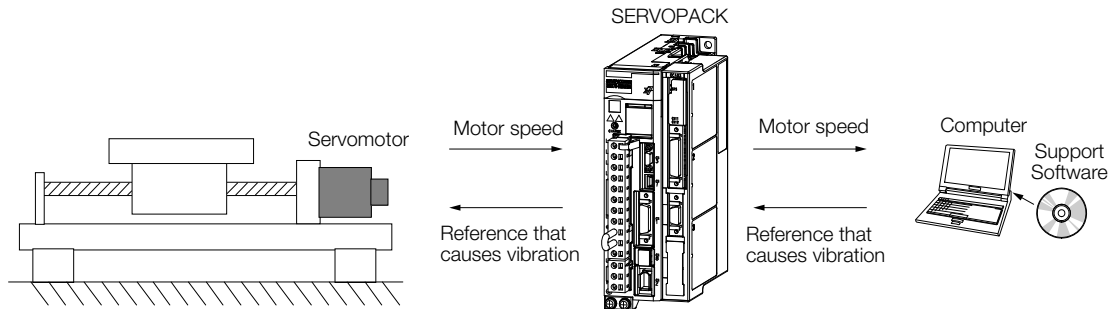

The Servomotor is used to cause machine vibration and then the speed frequency characteristics for the motor torque are measured. The measured frequency characteristics can be used to determine the machine resonance.

You determine the machine resonance for use in servo tuning and as reference for considering changes to the machine. The performance of the servo cannot be completely utilized depending on the rigidity of the machine. You may need to consider making changes to the machine. The information can also be used as reference for servo tuning to help you adjust parameters, such as the servo rigidity and torque filter time constant.

You can also use the information to set parameters, such as the notch filters.

WARNING

- Mechanical analysis requires operating the Servomotor and therefore presents hazards. Before you execute mechanical analysis, check the information provided in the SigmaWin+ operating manual.

Frequency Characteristics

The Servomotor is used to cause the machine to vibrate and the frequency characteristics from the torque to the motor speed are measured to determine the machine characteristics. For a normal machine, the resonance frequencies are clear when the frequency characteristics are plotted on graphs with the gain and phase (Bode plots). The Bode plots show the size (gain) of the response of the machine to which the torque is applied, and the phase delay (phase) in the response for each frequency. Also, the machine resonance frequency can be determined from the maximum frequency of the valleys (anti-resonance) and peaks (resonance) of the gain and the phase delay.

For a Servomotor without a load or for a rigid mechanism, the gain and phase change gradually in the Bode plots.

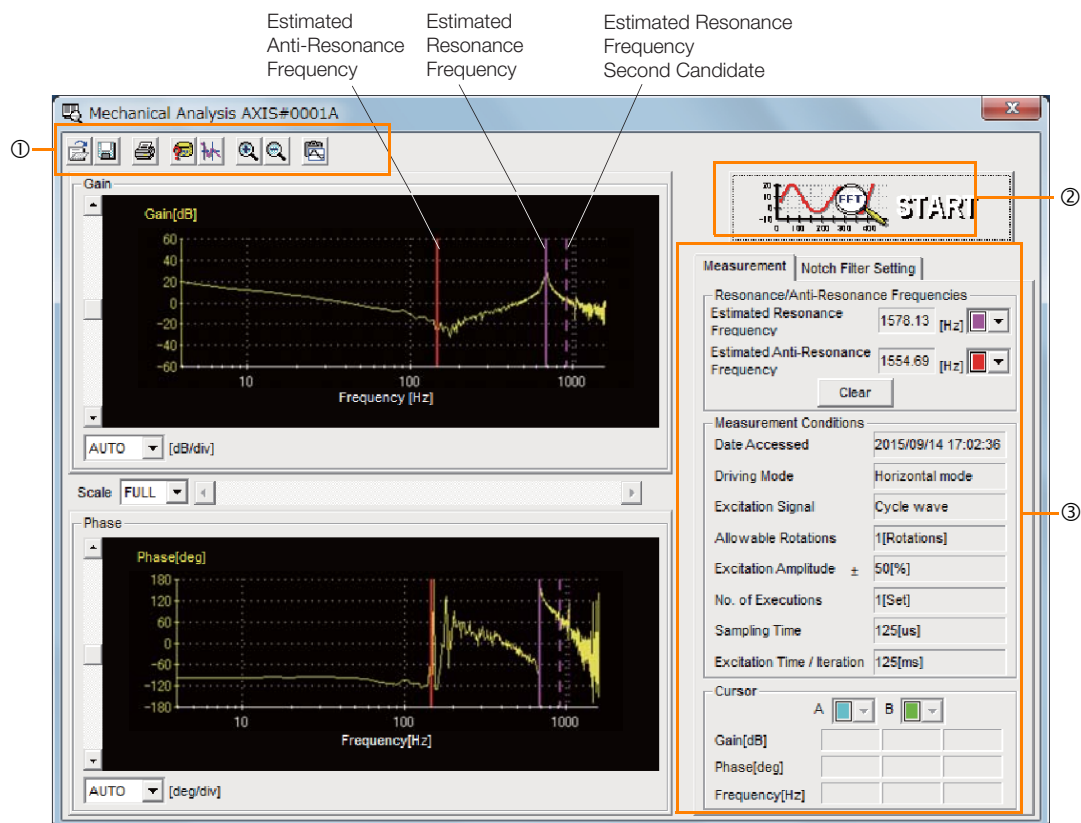

① Toolbar

② **START** Button

Click the **START** Button to start analysis.

③ **Measurement** and **Notch Filter Setting** Tab Pages

Measurement Tab Page: Displays detailed information on the results of analysis.

Notch Filter Setting Tab Page: Displays the notch filter frequencies. You can set these values in the parameters.

8.14.2 Easy FFT

The machine is made to vibrate and a resonance frequency is detected from the generated vibration to set notch filters according to the detected resonance frequencies. This is used to eliminate high-frequency vibration and noise.

During execution of Easy FFT, a frequency waveform reference is sent from the SERVOPACK to the Servomotor to automatically cause the shaft to rotate multiple times within 1/4th of a rotation, thus causing the machine to vibrate.

Execute Easy FFT after the servo is turned OFF if operation of the SERVOPACK results in high-frequency noise and vibration.

! WARNING

● Never touch the Servomotor or machine during execution of Easy FFT. Doing so may result in injury.

! CAUTION

● Use Easy FFT when the servo gain is low, such as in the initial stage of servo tuning. If you execute Easy FFT after you increase the gain, the machine may vibrate depending on the machine characteristics or gain balance.

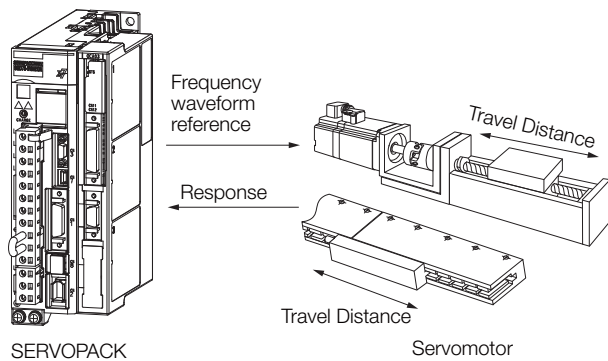

Easy FFT is built into the SERVOPACK for compatibility with previous products. Normally use autotuning without a host reference for tuning.

Preparations

Always check the following before you execute Easy FFT.

- The parameters must not be write prohibited.
- The main circuit power supply must be ON.
- The test without a motor function must be disabled (Pn00C = n.□□□0).
- There must be no alarms.
- There must be no hard wire base block (HWBB).
- The servo must be OFF.
- There must be no overtravel.
- An external reference must not be input.

Applicable Tools

The following table lists the tools that you can use to perform EasyFFT.

Tool	Fn No./Function Name	Operating Procedure Reference
Digital Operator	Fn206	Σ-7-Series Digital Operator Operating Manual (Manual No.: SIEP S800001 33)
SigmaWin+	<i>Diagnostic – Easy FFT</i>	Operating Procedure on page 8-91

Operating Procedure

Use the following procedure for Easy FFT.

1. Click the  Servo Drive Button in the workspace of the Main Window of the SigmaWin+.
2. Select **Easy FFT** in the Menu Dialog Box.
The Easy FFT Dialog Box will be displayed.
Click the **Cancel** Button to cancel Easy FFT. You will return to the main window.
3. Click the **OK** Button.

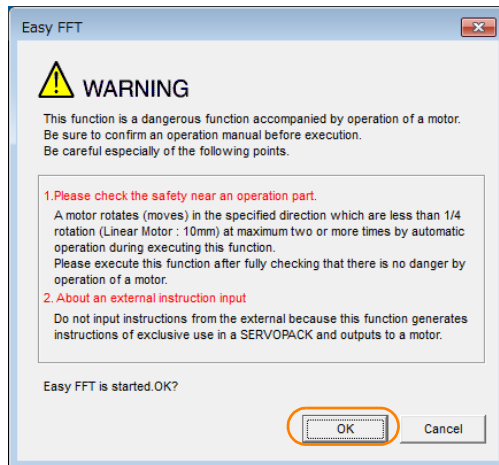

4. Click the **Servo ON** Button.

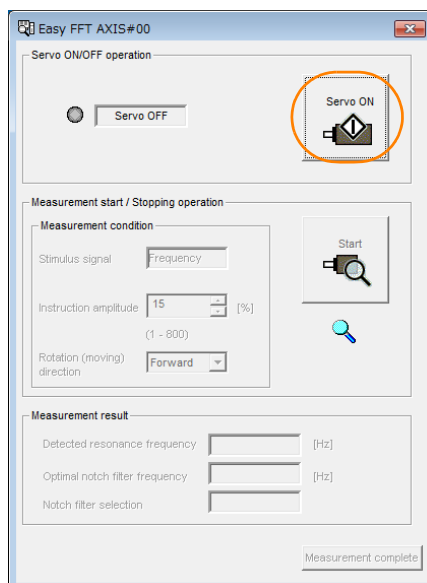

5. Select the instruction (reference) amplitude and the rotation direction in the **Measurement condition Area**, and then click the **Start Button**.
The Servomotor shaft will rotate and measurements will start.

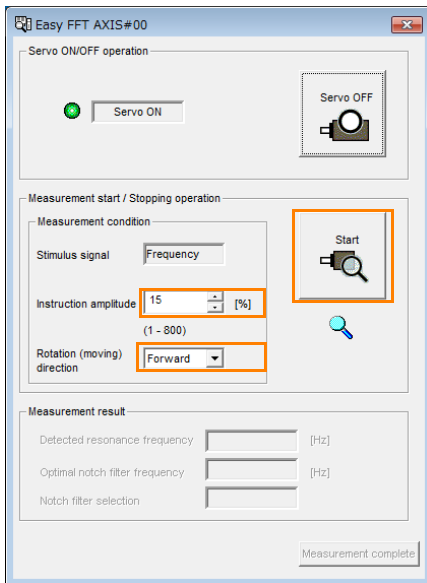

When measurements have been completed, the measurement results will be displayed.

6. Check the results in the **Measurement result Area** and then click the **Measurement complete Button**.

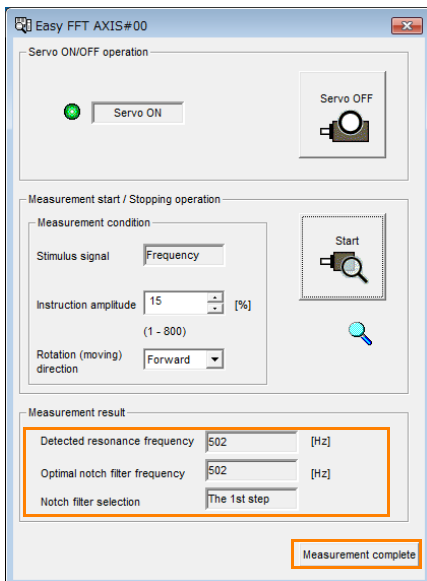

7. Click the **Result Writing Button** if you want to set the measurement results in the parameters.

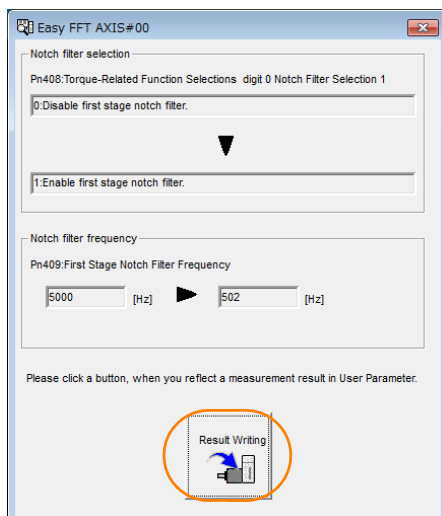

This concludes the procedure to set up Easy FFT.

Related Parameters

The following parameters are automatically adjusted or used as reference when you execute Easy FFT.

Do not change the settings of these parameters during execution of Easy FFT.

Parameter	Name	Automatic Changes
Pn408	Torque-Related Function Selections	Yes
Pn409	First Stage Notch Filter Frequency	Yes
Pn40A	First Stage Notch Filter Q Value	No
Pn40C	Second Stage Notch Filter Frequency	Yes
Pn40D	Second Stage Notch Filter Q Value	No
Pn456	Sweep Torque Reference Amplitude	No

Yes: The parameter is automatically set.

No: The parameter is not automatically set, but the setting is read during execution.

Monitoring

9

This chapter provides information on monitoring SERVOPACK product information and SERVOPACK status.

9.1	Monitoring Product Information	9-2
9.1.1	Items That You Can Monitor	9-2
9.1.2	Operating Procedures	9-2
9.2	Monitoring SERVOPACK Status	9-3
9.2.1	Servo Drive Status	9-3
9.2.2	Monitoring Operation, Status, and I/O	9-3
9.2.3	I/O Signals Status Monitor	9-5
9.3	Monitoring Machine Operation Status and Signal Waveforms	9-7
9.3.1	Items That You Can Monitor	9-7
9.3.2	Using the SigmaWin+	9-8
9.3.3	Using the Analog Monitors	9-10
9.4	Monitoring Product Life	9-14
9.4.1	Items That You Can Monitor	9-14
9.4.2	Operating Procedure	9-15
9.4.3	Preventative Maintenance	9-16
9.5	Alarm Tracing	9-17
9.5.1	Data for Which Alarm Tracing Is Performed	9-17
9.5.2	Applicable Tools	9-17

9.1 Monitoring Product Information

9.1.1 Items That You Can Monitor

Monitor Items	
Information on SERVOPACKs	<ul style="list-style-type: none"> • Model/Type • Serial Number • Manufacturing Date • Software version (SW Ver.) • Remarks
Information on Servomotors	<ul style="list-style-type: none"> • Model/Type • Serial Number • Manufacturing Date • Remarks
Information on Encoders	<ul style="list-style-type: none"> • Model/Type • Serial Number • Manufacturing Date • Software version (SW Ver.) • Remarks
Information on Option Modules	<ul style="list-style-type: none"> • Model/Type • Serial Number • Manufacturing Date • Software version (SW Ver.) • Remarks

9.1.2 Operating Procedures

Use the following procedure to display the Servo Drive product information.

- Select **Read Product Information** in the Menu Dialog Box of the SigmaWin+. The Read Product Information Window will be displayed.



Information With the Digital Operator, you can use Fn011, Fn012, and Fn01E to monitor this information. Refer to the following manual for the differences in the monitor items compared with the SigmaWin+.

📖 Σ -7-Series Digital Operator Operating Manual (Manual No.: SIEP S800001 33)

9.2 Monitoring SERVOPACK Status

9.2.1 Servo Drive Status

Use the following procedure to display the Servo Drive status.

- Start the SigmaWin+. The Servo Drive status will be automatically displayed when you go online with a SERVOPACK.

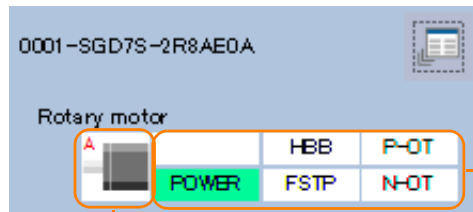

The Servo Drive status is displayed.

The Servomotor type is displayed.

9.2.2 Monitoring Operation, Status, and I/O

Items That You Can Monitor

The items that you can monitor on the Operation Pane, Status Pane, and I/O Pane are listed below.

- Operation Pane

Monitor Items	
<ul style="list-style-type: none"> • Error Monitor • Current issue position • Current motor position • Target position • Target distance • Registration target position • Registration target distance • Program step • Program event lapse time • Program loop pass through time • Number of serial command receipt letter • Number of serial command transmission error letter • Number of serial command transmission letter • Motor Speed • Speed Reference • Internal Torque Reference • Angle of Rotation 1 (number of encoder pulses from encoder phase C) • Angle of Rotation 2 (electrical angle from polarity origin) 	<ul style="list-style-type: none"> • Input Reference Pulse Speed • Deviation Counter (Position Deviation) • Cumulative Load • Regenerative Load • Power Consumption • Consumed Power • Cumulative Power Consumption • DB Resistor Consumption Power • Absolute Encoder Multiturn Data • Absolute Encoder Position within One Rotation • Absolute Encoder (Lower) • Absolute Encoder (Upper) • Input Reference Pulse Counter • Feedback Pulse Counter • Fully Closed Feedback Pulse Counter • Total Operating Time

• Status Pane

Monitor Items	
<ul style="list-style-type: none"> • Main Circuit • Encoder (PGRDY) • Motor Power (Request) • Motor Power ON • Dynamic Brake (DB) • Rotation (Movement) Direction • Mode Switch • Speed Reference (V-Ref) • Torque Reference (T-Ref) • Position Reference (PULS) • Position Reference Direction • Surge Current Limiting Resistor Short Relay 	<ul style="list-style-type: none"> • Regenerative Transistor • Regenerative Error Detection • AC Power ON • Overcurrent • Origin Not Passed • /INPOSITION (Positioning completed) state • NEAR (Positioning Proximity) state • DEN (Command Distribution Completed) state • Positioning is Interrupting or the Program Operation is Interrupting • Program Operation state • Current (Torque) Limit state • Main Power state

• I/O Pane

Monitor Items		
Input Signal Status	<ul style="list-style-type: none"> • /S-ON (Servo ON Input Signal) • P-OT (Forward Drive Prohibit Input Signal) • N-OT (Reverse Drive Prohibit Input Signal) • /ALM-RST (Alarm Reset Input Signal) • /DEC (Homing Deceleration Switch Input Signal) • /RGRT (Registration Input) signal • /MODE 0/1 (Mode Switch Input) signal • /START-STOP (Program Table Operation Start-Stop Input) signal • /PGMRES (Program Table Operation Reset Input) signal • /SEL0 (Program Step Selection Input 0) signal • /SEL1 (Program Step Selection Input 1) signal • /SEL2 (Program Step Selection Input 2) signal • /SEL3 (Program Step Selection Input 3) signal • /SEL4 (Program Step Selection Input 4) signal • /SEL5 (Program Step Selection Input 5) signal • /SEL6 (Program Step Selection Input 6) signal • /SEL7 (Program Step Selection Input 7) signal • /HOME (Homing Input) signal • /JOGP (Forward Jog Input) signal • /JOGN (Reverse Jog Input) signal • /JOG0 (Jog Speed Table Selection Input 0) signal • /JOG1 (Jog Speed Table Selection Input 1) signal • /JOG2 (Jog Speed Table Selection Input 2) signal • /JOG3 (Jog Speed Table Selection Input 3) signal 	Output Signal Status
	<ul style="list-style-type: none"> • ALM (Servo Alarm Output Signal) • /S-RDY (Servo Ready Output Signal) • /BK (Brake Output Signal) • /WARN (Warning Output Signal) • PAO (Encoder Divided Pulse Output Phase A Signal) • PBO (Encoder Divided Pulse Output Phase B Signal) • PCO (Encoder Divided Pulse Output Phase C Signal) • /ALO1, /ALO2, and /ALO3 (Alarm Code Output) signals • /INPOSITION (Positioning Completion Output) signal • /POUT0 (Programmable Output 0) signal • /POUT1 (Programmable Output 1) signal • /POUT2 (Programmable Output 2) signal • /POUT3 (Programmable Output 3) signal • /POUT4 (Programmable Output 4) signal • /POUT5 (Programmable Output 5) signal • /POUT6 (Programmable Output 6) signal • /POUT7 (Programmable Output 7) signal 	

Operating Procedure

Use the following procedure to display the Operation Monitor, Status Monitor, and I/O Monitor for the SERVOPACK.

- Select **Monitor** in the Menu Dialog Box of the SigmaWin+. The Operation Pane, Status Pane, and I/O Pane will be displayed in the Monitor Window.

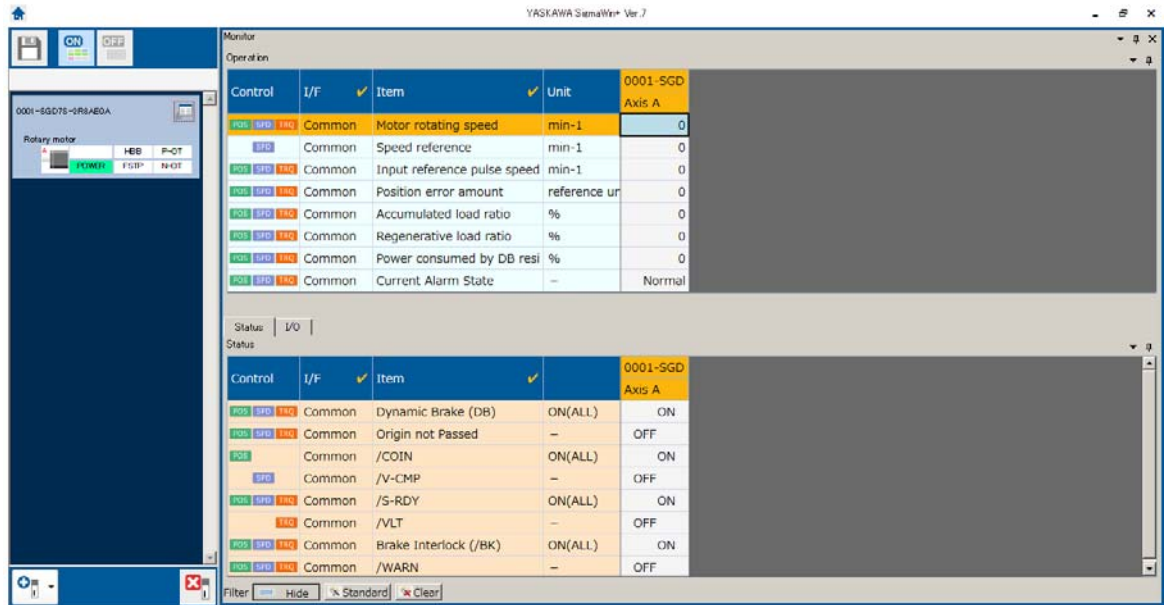

Information

You can flexibly change the contents that are displayed in the Monitor Window. Refer to the following manual for details.

📖 *Engineering Tool SigmaWin+ Operation Manual* (Manual No.: SIET S800001 34)

9.2.3 I/O Signals Status Monitor

Use the following procedure to check the status of the I/O signals.

1. Click the  Servo Drive Button in the workspace of the Main Window of the SigmaWin+.
2. Select **I/O Signal Allocation** in the Menu Dialog Box.
The I/O Signal Allocation Window will be displayed.

3. Click the Input Signal Tab.

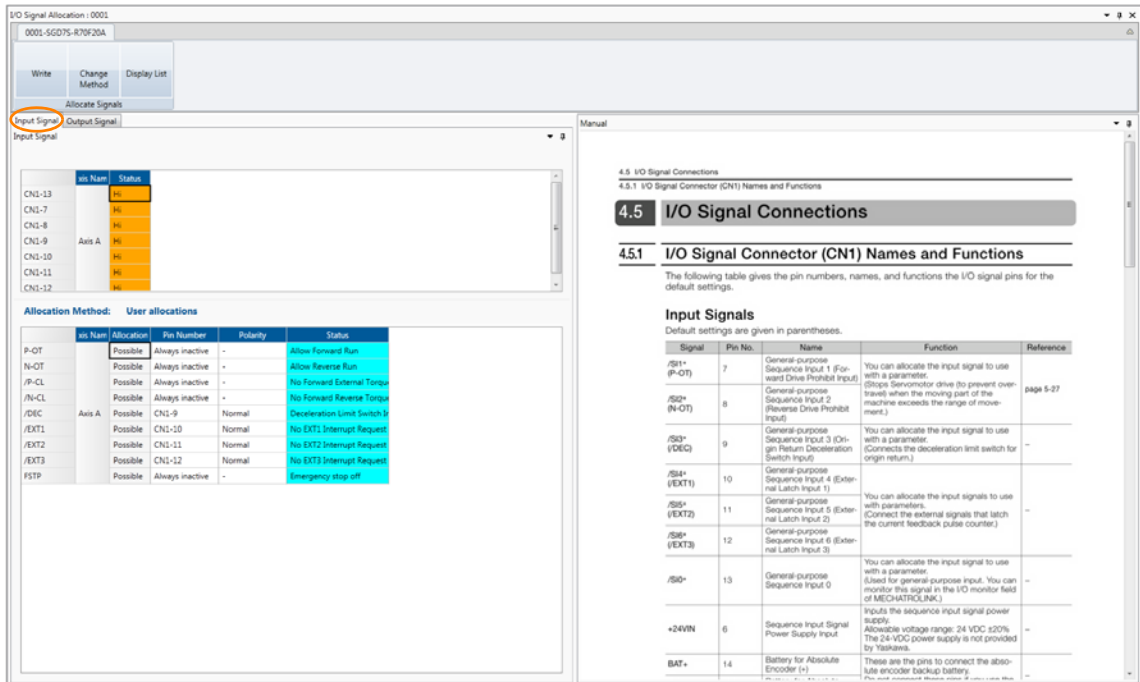

Check the status of the input signals.

4. Click the Output Signal Tab.

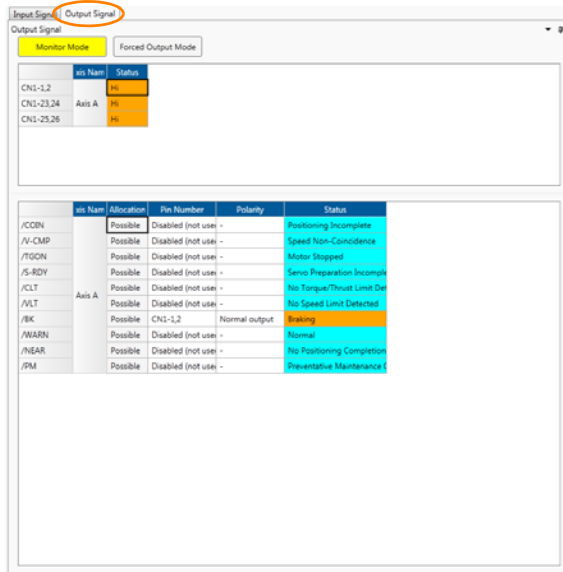

Check the status of the output signals.

Information

You can also use the above window to check wiring.

- **Checking Input Signal Wiring**
Change the signal status at the host controller. If the input signal status on the window changes accordingly, then the wiring is correct.
- **Checking Output Signal Wiring**
Click the **Force Output Mode** Button. This will force the output signal status to change. If the signal status at the host controller changes accordingly, then the wiring is correct. You cannot use the **Force Output Mode** Button while the servo is ON.

For details, refer to the following manual.

📖 AC Servo Drive Engineering Tool SigmaWin+ Operation Manual (Manual No.: SIET S800001 34)

9.3 Monitoring Machine Operation Status and Signal Waveforms

To monitor waveforms, use the SigmaWin+ trace function or a measuring instrument, such as a memory recorder.

9.3.1 Items That You Can Monitor

You can use the SigmaWin+ or a measuring instrument to monitor the shaded items in the following block diagram.

• Rotary Servomotors

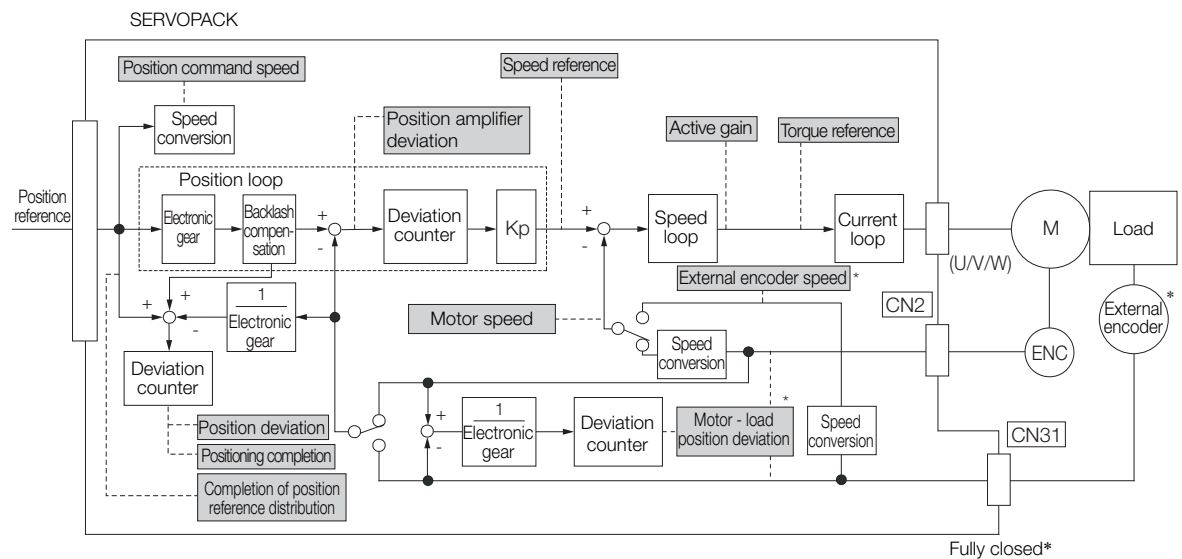

* This speed is available when fully-closed loop control is being used.

• Linear Servomotors

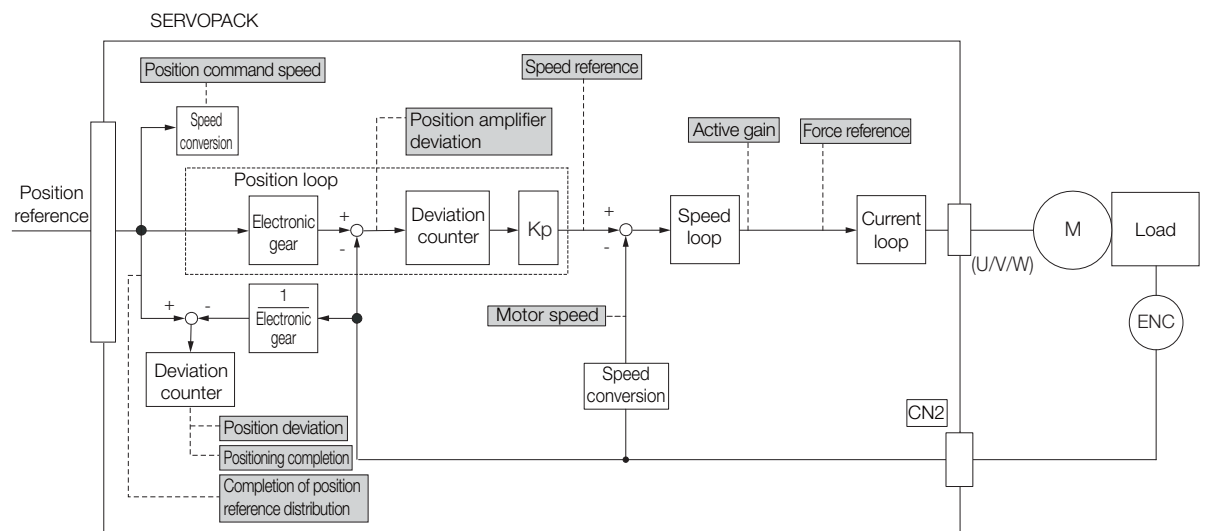

9.3.2 Using the SigmaWin+

This section describes how to trace data and I/O with the SigmaWin+.

Refer to the following manual for detailed operating procedures for the SigmaWin+.

📖 Engineering Tool SigmaWin+ Operation Manual (Manual No.: SIET S800001 34)

1. Click the  Servo Drive Button in the workspace of the Main Window of the SigmaWin+.
2. Select **Trace** in the Menu Dialog Box.
The Trace Dialog Box will be displayed.

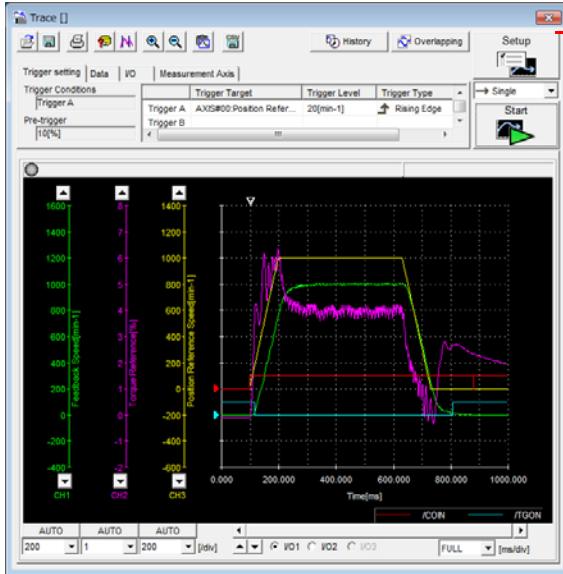

Click this button to display the Trace Setting Dialog Box shown below, and set the data to trace and the trace conditions.

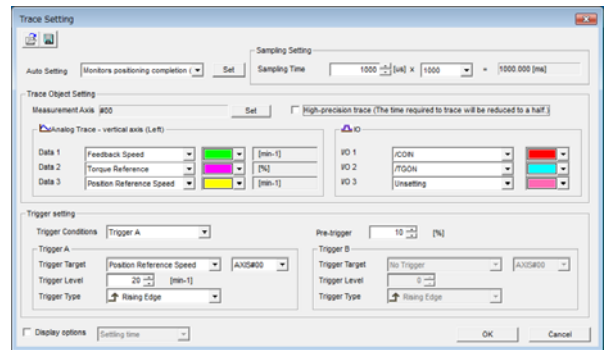

Trace Objects

You can trace the following items.

- Data Tracing

Trace Objects	
<ul style="list-style-type: none"> • Torque Reference • Feedback Speed • Reference Speed • Position Reference Speed • Position Error (Deviation) • Position Amplifier Error (Deviation) 	<ul style="list-style-type: none"> • Motor - Load Position Deviation • Speed Feedforward • Torque Feedforward • Effective (Active) Gain • Main Circuit DC Voltage • External Encoder Speed • Control Mode

• I/O Tracing

Trace Objects			
Input Signals	<ul style="list-style-type: none"> • /S-ON (Servo ON Input Signal) • P-OT (Forward Drive Prohibit Input Signal) • N-OT (Reverse Drive Prohibit Input Signal) • /ALM-RST (Alarm Reset Input Signal) • /DEC (Homing Deceleration Switch Input Signal) • /HWBB1 (Hard Wire Base Block Input 1 Signal) • /HWBB2 (Hard Wire Base Block Input 2 Signal) • /RGRT (Registration Input) signal • /HOME (Homing Input) signal 	Output Signals	<ul style="list-style-type: none"> • ALM (Servo Alarm Output Signal) • /S-RDY (Servo Ready Output Signal) • /BK (Brake Output Signal) • /WARN (Warning Output Signal) • PAO (Encoder Divided Pulse Output Phase A Signal) • PBO (Encoder Divided Pulse Output Phase B Signal) • PCO (Encoder Divided Pulse Output Phase C Signal) • /ALO1, /ALO2, and /ALO3 (Alarm Code Output) signals • /INPOSITION (Positioning Completion Output) signal
		Internal Status	<ul style="list-style-type: none"> • ACON (Main Circuit ON Signal) • PDETCMP (Polarity Detection Completed Signal) • DEN (Position Reference Distribution Completed Signal)

9.3.3 Using the Analog Monitors

Connect a measuring instrument, such as a memory recorder, to the analog monitor connector (CN5) on the SERVOPACK to monitor analog signal waveforms. The measuring instrument is not provided by Yaskawa.

Refer to the following section for details on the connection.

 4.8.3 Analog Monitor Connector (CN5) on page 4-50

Setting the Monitor Object

Use Pn006 = n.□□XX and Pn007 = n.□□XX (Analog Monitor 1 and 2 Signal Selections) to set the items to monitor.

Line Color	Signal	Parameter Setting
White	Analog monitor 1	Pn006 = n.□□XX
Red	Analog monitor 2	Pn007 = n.□□XX
Black (2 lines)	GND	–

Parameter	Description			
	Monitor Signal	Output Unit	Remarks	
Pn006 or Pn007	n.□□00 (default setting of Pn007)	Motor Speed	<ul style="list-style-type: none"> Rotary Servomotor: 1 V/1,000 min⁻¹ Linear Servomotor: 1 V/1,000 mm/s 	–
	n.□□01	Speed Reference	<ul style="list-style-type: none"> Rotary Servomotor: 1 V/1,000 min⁻¹ Linear Servomotor: 1 V/1,000 mm/s 	–
	n.□□02 (default setting of Pn006)	Torque Reference	1 V/100% rated torque	–
	n.□□03	Position Deviation	0.05 V/Reference unit	–
	n.□□04	Position Amplifier Deviation	0.05 V/encoder pulse unit	Position deviation after electronic gear conversion
	n.□□05	Position Command Speed	<ul style="list-style-type: none"> Rotary Servomotor: 1 V/1,000 min⁻¹ Linear Servomotor: 1 V/1,000 mm/s 	–
	n.□□06	Reserved parameter (Do not change.)	–	–
	n.□□07	Motor - Load Position Deviation	0.01 V/Reference unit	–
	n.□□08	Positioning Completion	Positioning completed: 5 V Positioning not completed: 0 V	Completion is indi- cated by the output voltage.
	n.□□09	Speed Feedforward	<ul style="list-style-type: none"> Rotary Servomotor: 1 V/1,000 min⁻¹ Linear Servomotor: 1 V/1,000 mm/s 	–
	n.□□0A	Torque Feedforward	1 V/100% rated torque	–
	n.□□0B	Active Gain*	1st gain: 1 V 2nd gain: 2 V	The gain that is active is indicated by the output volt- age.
	n.□□0C	Completion of Position Reference Distribution	Distribution completed: 5 V Distribution not completed: 0 V	Completion is indi- cated by the output voltage.
	n.□□0D	External Encoder Speed	1 V/1,000 min ⁻¹	Value calculated at the motor shaft
n.□□10	Main Circuit DC Voltage	1 V/100 V (main circuit DC voltage)	–	

* Refer to the following section for details.

 8.12.1 Automatic Gain Switching on page 8-64

Changing the Monitor Factor and Offset

You can change the monitor factors and offsets for the output voltages for analog monitor 1 and analog monitor 2. The relationships to the output voltages are as follows:

$$\text{Analog monitor 1 output voltage} = (-1) \times \left\{ \begin{array}{l} \text{Analog Monitor 1 Signal} \\ \text{Selection (Pn006 = n.}\square\square\text{XX)} \end{array} \times \begin{array}{l} \text{Analog Monitor 1} \\ \text{Magnification (Pn552)} \end{array} + \begin{array}{l} \text{Analog Monitor 1} \\ \text{Offset Voltage (Pn550)} \end{array} \right\}$$

$$\text{Analog monitor 2 output voltage} = (-1) \times \left\{ \begin{array}{l} \text{Analog Monitor 2 Signal} \\ \text{Selection (Pn007 = n.}\square\square\text{XX)} \end{array} \times \begin{array}{l} \text{Analog Monitor 2} \\ \text{Magnification (Pn553)} \end{array} + \begin{array}{l} \text{Analog Monitor 2} \\ \text{Offset Voltage (Pn551)} \end{array} \right\}$$

The following parameters are set.

Pn550	Analog Monitor 1 Offset Voltage				
	Setting Range	Setting Unit	Default Setting	When Enabled	Classification
	-10,000 to 10,000	0.1 V	0	Immediately	Setup
Pn551	Analog Monitor 2 Offset Voltage				
	Setting Range	Setting Unit	Default Setting	When Enabled	Classification
	-10,000 to 10,000	0.1 V	0	Immediately	Setup
Pn552	Analog Monitor 1 Magnification				
	Setting Range	Setting Unit	Default Setting	When Enabled	Classification
	-10,000 to 10,000	x0.01	100	Immediately	Setup
Pn553	Analog Monitor 2 Magnification				
	Setting Range	Setting Unit	Default Setting	When Enabled	Classification
	-10,000 to 10,000	x0.01	100	Immediately	Setup

Example

- Example for Setting the Item to Monitor to the Motor Speed (Pn006 = n.□□00)

When Pn552 = 100 (Setting Unit: x0.01)

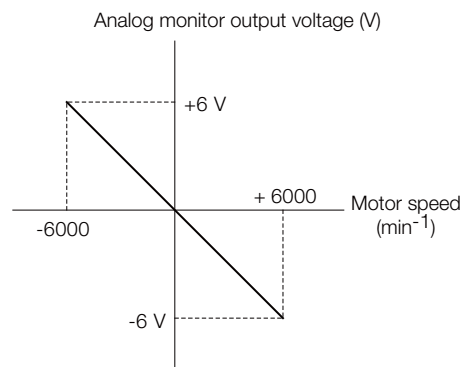

When Pn552 = 1,000 (Setting Unit: x0.01)

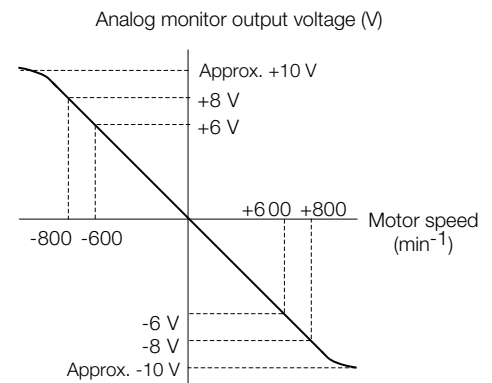

Note: The effective linearity range is ±8 V.
The resolution is 16 bits.

Adjusting the Analog Monitor Output

You can manually adjust the offset and gain for the analog monitor outputs for the torque reference monitor and motor speed monitor.

The offset is adjusted to compensate for offset in the zero point caused by output voltage drift or noise in the monitoring system.

The gain is adjusted to match the sensitivity of the measuring system.

The offset and gain are adjusted at the factory. You normally do not need to adjust them.

◆ Adjustment Example

An example of adjusting the output of the motor speed monitor is provided below.

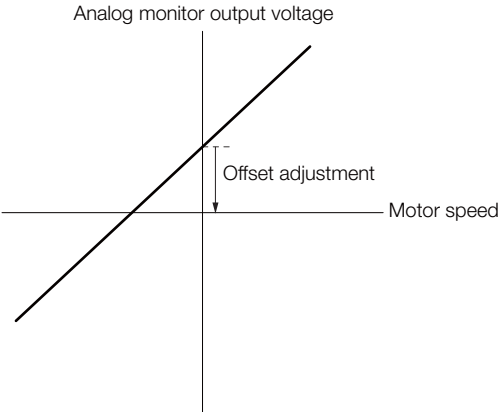
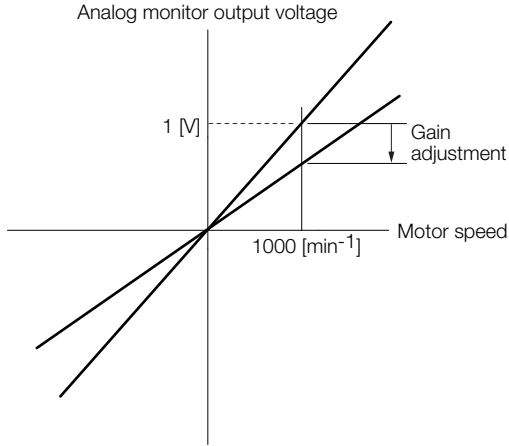
Offset Adjustment		Gain Adjustment	
			
Item	Specification	Item	Specification
Offset Adjustment Range	-2.4 V to 2.4 V	Gain Adjustment Range	100 ±50%
Adjustment Unit	18.9 mV/LSB	Adjustment Unit	0.4%/LSB

The gain adjustment range is made using a 100% output value (gain adjustment of 0) as the reference value with an adjustment range of 50% to 150%. A setting example is given below.

- Setting the Adjustment Value to -125
 $100 + (-125 \times 0.4) = 50 \text{ [%]}$
 Therefore, the monitor output voltage goes to 50% of the original value.
- Setting the Adjustment Value to 125
 $100 + (125 \times 0.4) = 150 \text{ [%]}$
 Therefore, the monitor output voltage goes to 150% of the original value.

- Information**
- The adjustment values do not use parameters, so they will not change even if the parameter settings are initialized.
 - Adjust the offset with the measuring instrument connected so that the analog monitor output value goes to zero. The following setting example achieves a zero output.
 - While power is not supplied to the Servomotor, set the monitor signal to the torque reference.
 - In speed control, set the monitor signal to the position deviation.

◆ Preparations



Always check the following before you adjust the analog monitor output.

- The parameters must not be write prohibited.

◆ Applicable Tools

You can use the following tools to adjust analog monitor outputs.

- Offset Adjustment

Tool	Fn No./Function Name	Operating Procedure Reference
Digital Operator	Fn00C	 Σ-7-Series Digital Operator Operating Manual (Manual No.: SIEP S800001 33)
SigmaWin+	Others – Adjust the Analog Monitor Output	 ◆ Operating Procedure on page 9-13

- Gain Adjustment

Tool	Fn No./Function Name	Operating Procedure Reference
Digital Operator	Fn00D	Σ -7-Series Digital Operator Operating Manual (Manual No.: SIEP S80001 33)
SigmaWin+	Others – Adjust the Analog Monitor Output	Operating Procedure on page 9-13

◆ Operating Procedure

Use the following procedure to adjust the analog monitor output.

1. Click the Servo Drive Button in the workspace of the Main Window of the SigmaWin+.
2. Select **Adjust the Analog Monitor Output** in the Menu Dialog Box. The Adjust the Analog Monitor Output Dialog Box will be displayed.
3. Click the **Zero Adjustment** or **Gain Adjustment** Tab.

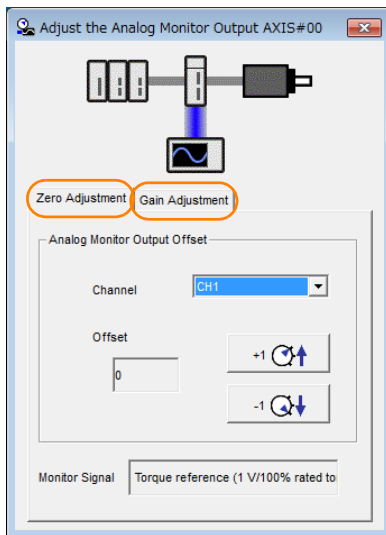



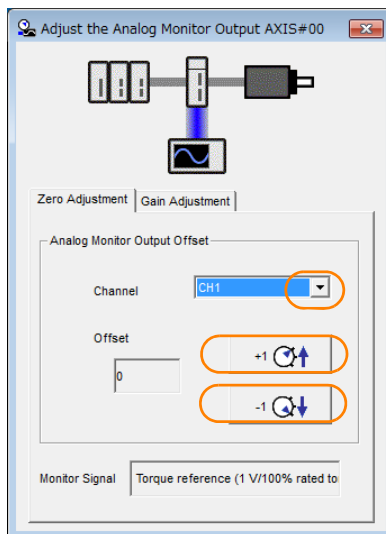

4. While watching the analog monitor, use the **+1** and **-1** Buttons to adjust the offset. There are two channels: CH1 and CH2. If necessary, click the down arrow on the **Channel** Box and select the channel.



This concludes adjusting the analog monitor output.

9.4 Monitoring Product Life

9.4.1 Items That You Can Monitor

Monitor Item	Description
SERVOPACK Installation Environment	The operating status of the SERVOPACK in terms of the installation environment is displayed. Implement one or more of the following actions if the monitor value exceeds 100%. <ul style="list-style-type: none"> • Lower the surrounding temperature. • Decrease the load.
Servomotor Installation Environment	The operating status of the SERVOPACK in terms of the installation environment is displayed. Implement one or more of the following actions if the monitor value exceeds 100%. <ul style="list-style-type: none"> • Lower the surrounding temperature. • Decrease the load.
Built-in Fan Service Life Prediction	The unused status of the SERVOPACK is treated as the 100% value. The value decreases each time the main circuit power supply is turned ON and each time the servo is turned OFF. Use a monitor value of 0% as a guideline for the replacement period. Refer to the following section for part replacement guidelines.  <i>15.1.2 Guidelines for Part Replacement on page 15-2</i>
Capacitor Service Life Prediction	The unused status of the SERVOPACK is treated as the 100% value. The value decreases each time the main circuit power supply is turned ON and each time the servo is turned OFF. Use a monitor value of 0% as a guideline for the replacement period. Refer to the following section for part replacement guidelines.  <i>15.1.2 Guidelines for Part Replacement on page 15-2</i>
Surge Prevention Circuit Service Life Prediction	The unused status of the SERVOPACK is treated as the 100% value. The value decreases each time the main circuit power supply is turned ON and each time the servo is turned OFF. Use a monitor value of 0% as a guideline for the replacement period. Refer to the following section for part replacement guidelines.  <i>15.1.2 Guidelines for Part Replacement on page 15-2</i>
Dynamic Brake Circuit Service Life Prediction	The unused status of the SERVOPACK is treated as the 100% value. The value decreases each time the main circuit power supply is turned ON and each time the servo is turned OFF. Use a monitor value of 0% as a guideline for the replacement period. Refer to the following section for part replacement guidelines.  <i>15.1.2 Guidelines for Part Replacement on page 15-2</i>

9.4.2 Operating Procedure

Use the following procedure to display the installation environment and service life prediction monitor dialog boxes.

1. Click the  Servo Drive Button in the workspace of the Main Window of the SigmaWin+.
2. Select **Life Monitor** in the Menu Dialog Box.
The Life Monitor Dialog Box will be displayed.

Information With the Digital Operator, you can use Un025 to Un02A to monitor this information.

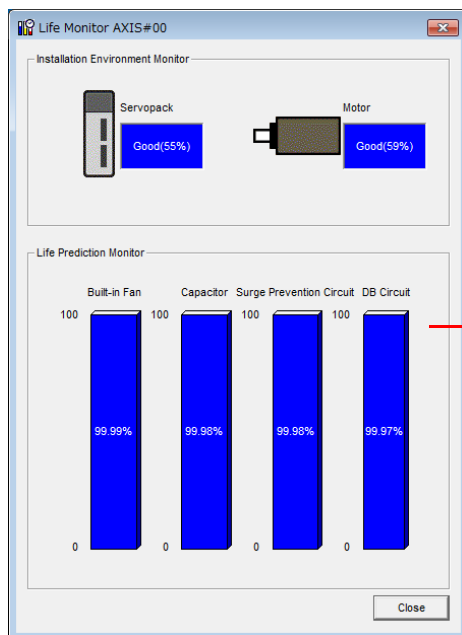

A value of 100% indicates that the SERVOPACK has not yet been used. The percentage decreases as the SERVOPACK is used and reaches 0% when it is time to replace the SERVOPACK.

9.4.3 Preventative Maintenance

You can use preventative maintenance warnings for preventative maintenance. The SERVOPACK can notify the host controller when it is time to replace any of the main parts.

Preventative Maintenance Warning

An A.9b0 warning (Preventative Maintenance Warning) is detected when any of the following service life prediction values drops to 10% or less: SERVOPACK built-in fan life, capacitor life, inrush current limiting circuit life, and dynamic brake circuit life. You can change the setting of Pn00F = n.□□□X to enable or disable these warnings.

Parameter		Description	When Enabled	Classification
Pn00F	n.□□□0 (default setting)	Do not detect preventative maintenance warnings.	After restart	Setup
	n.□□□1	Detect preventative maintenance warnings.		

9.5 Alarm Tracing

Alarm tracing records data in the SERVOPACK from before and after an alarm occurs. This data helps you to isolate the cause of the alarm.

You can display the data recorded in the SERVOPACK as a trace waveform on the SigmaWin+.

Information

- Alarms that occur when the power supply is turned ON are not recorded.
- Alarms that occur during the recording of alarm trace data are not recorded.
- Alarms that occur while utility functions are being executed are not recorded.
- Alarms that occur while the data tracing function of the SigmaWin+ is being executed are not recorded.

9.5.1 Data for Which Alarm Tracing Is Performed

Two types of data are recorded for alarm tracing: numeric data and I/O signal ON/OFF data.

Numeric Data	ON/OFF Data
Torque reference	ALM
Feedback speed	Servo ON command (/S-ON)
Reference speed	Proportional control command (/P-CON)
Position reference speed	Forward torque command (/P-CL)
Position deviation	Reverse torque command (/N-CL)
Motor-load position deviation	G-SEL1 signal (/G-SEL1)
Main circuit bus voltage	ACON

9.5.2 Applicable Tools

The following table lists the tools that you can use to perform alarm tracing.

Tool	Fn No./Function Name	Operating Procedure Reference
Digital Operator	You cannot display alarm tracing data from the Digital Operator.	
SigmaWin+	Troubleshooting – Alarm Trace	 Engineering Tool SigmaWin+ Operation Manual (Manual No.: SIET S800001 34)

Fully-Closed Loop Control

10

This chapter provides detailed information on performing fully-closed loop control with the SERVOPACK.

10.1	Fully-Closed System	10-2
10.2	SERVOPACK Commissioning Procedure	10-3
10.3	Parameter Settings for Fully-Closed Loop Control	10-5
10.3.1	Control Block Diagram for Fully-Closed Loop Control	10-5
10.3.2	Setting the Motor Direction and the Machine Movement Direction	10-5
10.3.3	Setting the Number of External Encoder Scale Pitches	10-6
10.3.4	Setting the PAO, PBO, and PCO (Encoder Divided Pulse Output) Signals	10-7
10.3.5	Electronic Gear Setting	10-8
10.3.6	Alarm Detection Settings	10-9
10.3.7	Analog Monitor Signal Settings	10-10
10.3.8	Setting to Use an External Encoder for Speed Feedback	10-10

10.1 Fully-Closed System

With a fully-closed system, an externally installed encoder is used to detect the position of the controlled machine and the machine's position information is fed back to the SERVOPACK. High-precision positioning is possible because the actual machine position is fed back directly. With a fully-closed system, looseness or twisting of mechanical parts may cause vibration or oscillation, resulting in unstable positioning.

Refer to the following manual for details on Fully-closed Modules.

☞ Σ-7-Series Peripheral Device Selection Manual (Manual No.: S1EP S800001 32)

The following figure shows an example of the system configuration.

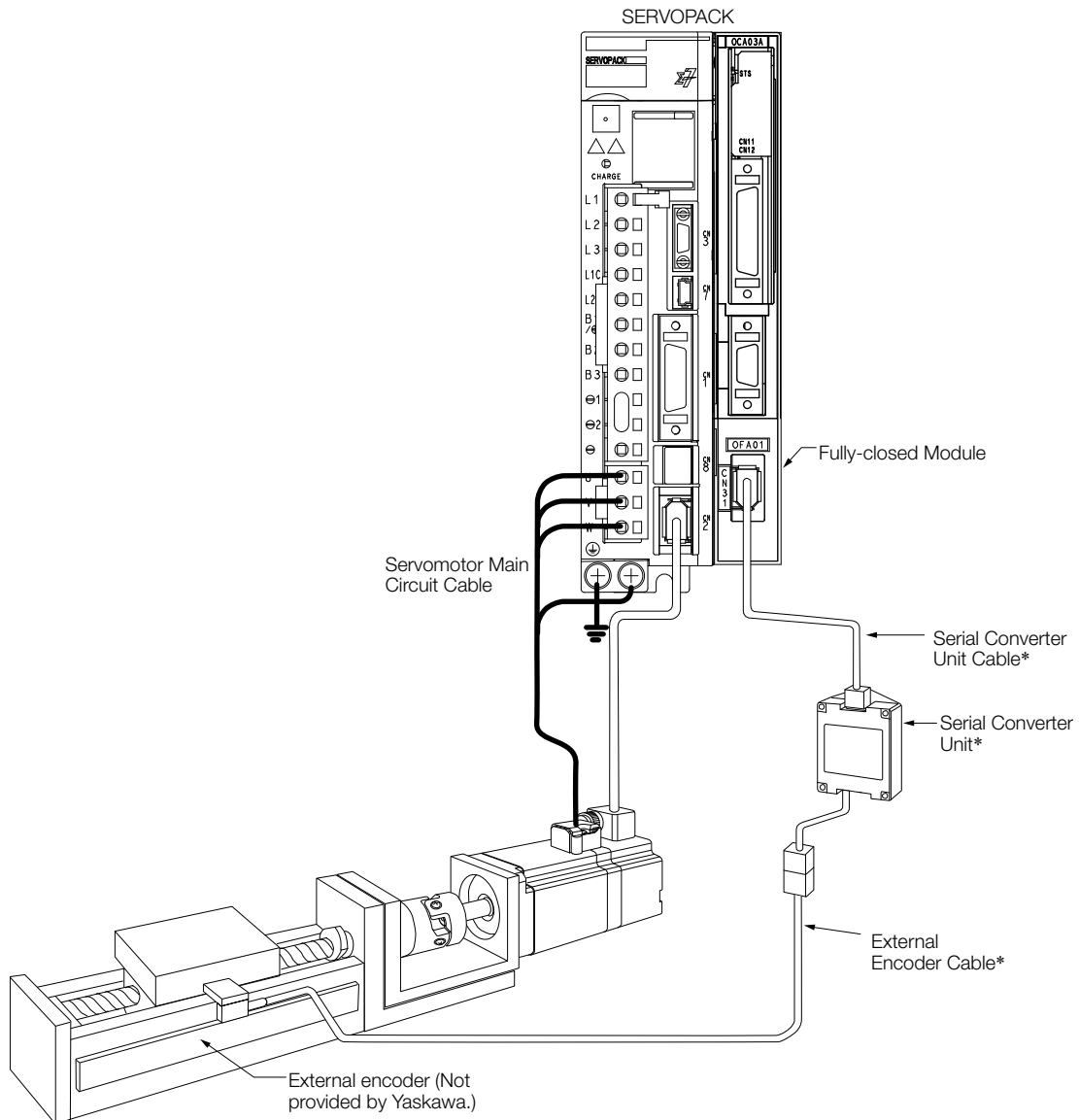

* The connected devices and cables depend on the type of external linear encoder that is used.

Note: Refer to the following section for details on connections that are not shown above, such as connections to power supplies and peripheral devices.

☞ *Duct-ventilated SERVOPACKs on page 2-25*

10.2 SERVOPACK Commissioning Procedure

First, confirm that the SERVOPACK operates correctly with semi-closed loop control, and then confirm that it operates correctly with fully-closed loop control. The commissioning procedure for the SERVOPACK for fully-closed loop control is given below.

Step	Description	Operation	Required Parameter Settings	Controlling Device
1	<p>Check operation of the entire sequence with semi-closed loop control and without a load.</p> <p>Items to Check</p> <ul style="list-style-type: none"> • Power supply circuit wiring • Servomotor wiring • Encoder wiring • Wiring of I/O signal lines from the host controller • Servomotor rotation direction, motor speed, and multiturn data • Operation of safety mechanisms, such as the brakes and the overtravel mechanisms 	<p>Set the parameters so that the SERVOPACK operates correctly in semi-closed loop control without a load and check the following points. Set Pn002 to n.0□□□ to specify semi-closed loop control.</p> <ul style="list-style-type: none"> • Are there any errors in the SERVOPACK? • Does jog operation function correctly when you operate the SERVOPACK without a load? • Do the I/O signals turn ON and OFF correctly? • Is power supplied to the Servomotor after the /S-ON signal is sent? • Does the Servomotor operate correctly when a position reference is input by the host controller? 	<ul style="list-style-type: none"> • Pn000 (Basic Function Select Switch 0) • Pn001 (Basic Function Select Switch 1) • Pn002 = n.X□□□ (External Encoder Usage) • Pn20E (Electronic Gear Ratio (Numerator)) • Pn210 (Electronic Gear Ratio (Denominator)) • PnB03 to PnB12 (Input Signal Selections) • PnB15 to PnB1E (Output Signal Selections) 	SERVO-PACK or host controller
2	<p>Check operation with the Servomotor connected to the machine with semi-closed loop control.</p> <p>Items to Check</p> <ul style="list-style-type: none"> • Initial response of the system connected to the machine • Movement direction, travel distance, and movement speed as specified by the references from the host controller 	<p>Connect the Servomotor to the machine. Set the moment of inertia ratio in Pn103 using autotuning without a host reference. Check that the machine's movement direction, travel distance, and movement speed agree with the references from the host controller.</p>	Pn103 (Moment of Inertia Ratio)	Host controller
3	<p>Check the external encoder.</p> <p>Items to Check</p> <p>Is the signal from the external encoder received correctly?</p>	<p>Set the parameters related to fully-closed loop control and move the machine with your hand without turning ON the power supply to the Servomotor. Check the following status with the Digital Operator or SigmaWin+.</p> <ul style="list-style-type: none"> • Does the fully-closed feedback pulse counter count up when the Servomotor moves in the forward direction? • Is the travel distance of the machine visually about the same as the amount counted by the fully-closed feedback pulse counter? <p>Note: The unit for the fully-closed feedback pulse counter is pulses, which is equivalent to the external encoder sine wave pitch.</p>	<ul style="list-style-type: none"> • Pn002 = n.X□□□ (External Encoder Usage) • Pn20A (Number of External Scale Pitches) • Pn20E (Electronic Gear Ratio (Numerator)) • Pn210 (Electronic Gear Ratio (Denominator)) • Pn281 (Encoder Output Resolution) • Pn51B (Motor-Load Position Deviation Overflow Detection Level) • Pn522 (Positioning Completed Width) • Pn52A (Multiplier per Fully-closed Rotation) 	—

Continued on next page.

Continued from previous page.

Step	Description	Operation	Required Parameter Settings	Controlling Device
4	Perform a program jog operation. Items to Check Does the fully-closed system operate correctly for the SERVOPACK without a load?	Perform a program jog operation and confirm that the travel distance is the same as the reference value in Pn531. When you perform program jog operation, start from a low speed and gradually increase the speed.	Pn530 to Pn536 (program jog operation-related parameters)	SERVO-PACK
5	Operate the SERVO-PACK. Items to Check Does the fully-closed system operate correctly, including the host controller?	Input a position reference and confirm that the SERVOPACK operates correctly. Start from a low speed and gradually increase the speed.	–	Host controller

10.3 Parameter Settings for Fully-Closed Loop Control

This section describes the parameter settings that are related to fully-closed loop control.

Parameter to Set	Setting	Reference
Pn000 = n.□□□X	Motor direction	page 10-5
Pn002 = n.X□□□	External encoder usage method	
Pn20A	Number of external scale pitches	page 10-6
Pn281	Encoder divided pulse output signals (PAO, PBO, and PCO) from the SERVOPACK	page 10-7
Pn20E and Pn210	Electronic gear ratio	page 5-41
Pn51B	Motor-Load Position Deviation Overflow Detection Level	page 10-9
Pn52A	Multiplier for fully-closed rotation	
Pn006/Pn007	Analog monitor signal	page 10-10
Pn22A = n.X□□□	Speed feedback method during fully-closed loop control	page 10-10

10.3.1 Control Block Diagram for Fully-Closed Loop Control

The control block diagram for fully-closed loop control is provided below.

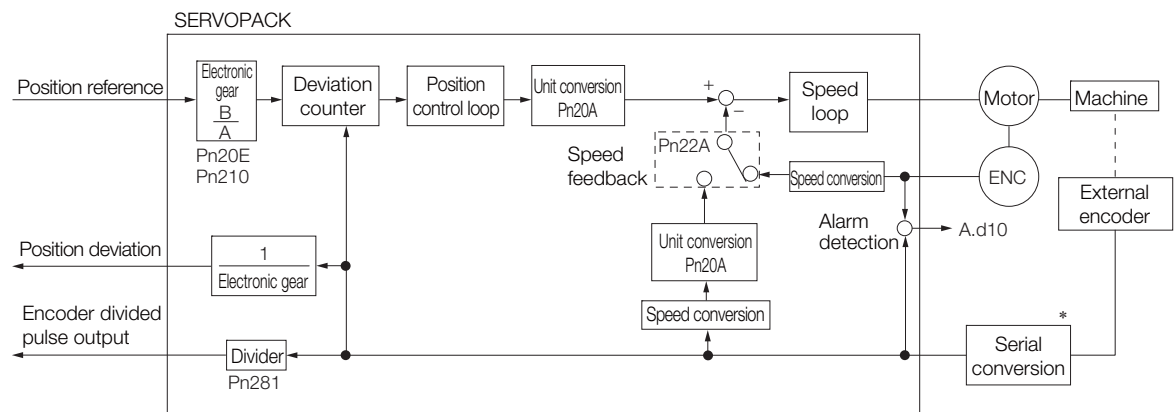

* The connected device depends on the type of external encoder.

Note: You can use either an incremental or an absolute encoder. If you use an absolute encoder, set Pn002 to n.□1□□ (Use the absolute encoder as an incremental encoder).

10.3.2 Setting the Motor Direction and the Machine Movement Direction

You must set the motor direction and the machine movement direction. To perform fully-closed loop control, you must set the motor rotation direction with both Pn000 = n.□□□X (Direction Selection) and Pn002 = n.X□□□ (External Encoder Usage).

Parameter			Pn002 = n.X□□□ (External Encoder Usage)			
			n.1□□□		n.3□□□	
Pn000 = n.□□□X (Direction Selection)	n.□□□0	Reference direction	Forward reference	Reverse reference	Forward reference	Reverse reference
		Motor direction	CCW	CW	CCW	CW
		External encoder	Forward movement	Reverse movement	Reverse movement	Forward movement
	n.□□□1	Reference direction	Forward reference	Reverse reference	Forward reference	Reverse reference
		Motor direction	CW	CCW	CW	CCW
		External encoder	Reverse movement	Forward movement	Forward movement	Reverse movement

10.3.3 Setting the Number of External Encoder Scale Pitches

- Phase B leads in the divided pulses for a forward reference regardless of the setting of Pn000 = n.□□□X.
- Forward direction: The direction in which the pulses are counted up.
- Reverse direction: The direction in which the pulses are counted down.

Related Parameters

◆ Pn000 = n.□□□X

Refer to the following section for details.

📖 5.4 Motor Direction Setting on page 5-15

◆ Pn002 = n.X□□□

When you perform fully-closed loop control, set Pn002 to n.1□□□ or n.3□□□.

Parameter	Name	Meaning	When Enabled	Classification
Pn002	n.0□□□ (default setting)	Do not use an external encoder.	After restart	Setup
	n.1□□□	External encoder moves in forward direction for CCW motor rotation.		
	n.2□□□	Reserved parameter (Do not change.)		
	n.3□□□	External encoder moves in reverse direction for CCW motor rotation.		
	n.4□□□	Reserved parameter (Do not change.)		

Information

Determine the setting of Pn002 = n.X□□□ as described below.

- Set Pn000 to n.□□□0 (Use the direction in which the linear encoder counts up as the forward direction) and set Pn002 to n.1□□□ (The external encoder moves in the forward direction for CCW motor rotation).
- Manually rotate the motor shaft counterclockwise.
- If the fully-closed feedback pulse counter counts up, do not change the setting of Pn002 (Pn002 = n.1□□□).
- If the fully-closed feedback pulse counter counts down, set Pn002 to n.3□□□.

10.3.3 Setting the Number of External Encoder Scale Pitches

Set the number of external encoder scale pitches per Servomotor rotation in Pn20A.

Setting Example

<p>Specifications External encoder scale pitch: 20 μm Ball screw lead: 30 mm</p>

If the external encoder is connected directly to the Servomotor, the setting will be 1,500 (30 mm/0.02 mm = 1,500).

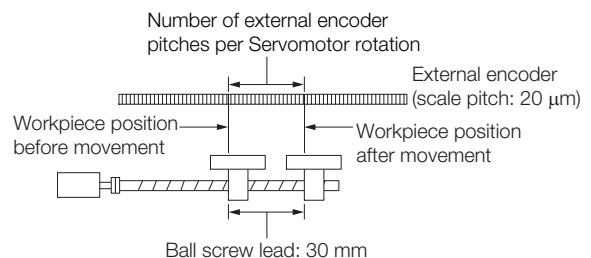

Note: 1. If there is a fraction, round off the digits below the decimal point.

2. If the number of external encoder scale pitches per Servomotor rotation is not an integer, there will be deviation in the position loop gain (Kp), feedforward, and position reference speed monitor. This is not relevant for the position loop and it therefore does not interfere with the position accuracy.

Related Parameter

Pn20A	Number of External Scale Pitches				
	Setting Range	Setting Unit	Default Setting	When Enabled	Classification
	4 to 1,048,576	1 scale pitch/revolution	32,768	After restart	Setup

10.3.4 Setting the PAO, PBO, and PCO (Encoder Divided Pulse Output) Signals

Set the position resolution in Pn281 (Encoder Output Resolution).

Enter the number of phase A and phase B edges for the setting.

Setting Example

<p>Specifications External encoder scale pitch: 20 μm Ball screw lead: 30 mm Speed: 1,600 mm/s</p>
--

If a single pulse (multiplied by 4) is output for 1 μm, the setting would be 20.

If a single pulse (multiplied by 4) is output for 0.5 μm, the setting would be 40.

The encoder divided pulse output would have the following waveform if the setting is 20.

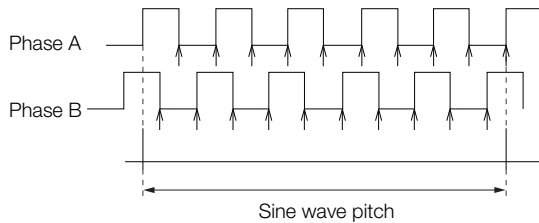

“↑” indicates the edge positions. In this example, the set value is 20 and therefore the number of edges is 20.

Note: The upper limit of the encoder signal output frequency (multiplied by 4) is 6.4 Mpps. Do not set a value that would cause the output to exceed 6.4 Mpps.

If the output exceeds the upper limit, an A.511 alarm (Overspeed of Encoder Output Pulse Rate) will be output.

Example

If the setting is 20 and the speed is 1,600 mm/s, the output frequency would be 1.6 Mpps

$$\frac{1600 \text{ mm/s}}{0.001 \text{ mm}} = 1,600,000 = 1.6 \text{ Mpps}$$

Because 1.6 Mpps is less than 6.4 Mpps, this setting can be used.

Related Parameter

Pn281	Encoder Output Resolution				
	Setting Range	Setting Unit	Default Setting	When Enabled	Classification
	1 to 4,096	1 edge/pitch	20	After restart	Setup

Note: 1. The maximum setting for the encoder output resolution is 4,096.

If the resolution of the external encoder exceeds 4,096, pulse output will no longer be possible at the resolution given in **Feedback Resolution of Linear Encoder** on page 5-44.

2. If the setting of Pn281 exceeds the resolution of the external encoder, the A.041 alarm (Encoder Output Pulse Setting Error) will be output.

10.3.5 Electronic Gear Setting

Refer to the following section for details.

 [5.14 Electronic Gear Settings](#) on page 5-41

With fully-closed loop control, the same setting as for a Linear Servomotor is used.

10.3.6 Alarm Detection Settings

This section describes the alarm detection settings (Pn51B and Pn52A).

Pn51B (Motor-Load Position Deviation Overflow Detection Level)

This setting is used to detect the difference between the feedback position of the Servomotor encoder and the feedback load position of the external encoder for fully-closed loop control. If the detected difference exceeds the setting, an A.d10 alarm (Motor-Load Position Error Overflow) will be output.

Pn51B	Motor-Load Position Deviation Overflow Detection Level				
	Setting Range	Setting Unit	Default Setting	When Enabled	Classification
	0 to 1,073,741,824	1 reference unit	1000	Immediately	Setup

Note: If you set this parameter to 0, A.d10 alarms will not be output and the machine may be damaged.

Pn52A (Multiplier per Fully-closed Rotation)

Set the coefficient of the deviation between the Servomotor and the external encoder per Servomotor rotation.

This setting can be used to prevent the Servomotor from running out of control due to damage to the external encoder or to detect belt slippage.

◆ Setting Example

Increase the value if the belt slips or is twisted excessively.

If this parameter is set to 0, the external encoder value will be read as it is.

If you use the default setting of 20, the second rotation will start with the deviation for the first Servomotor rotation multiplied by 0.8.

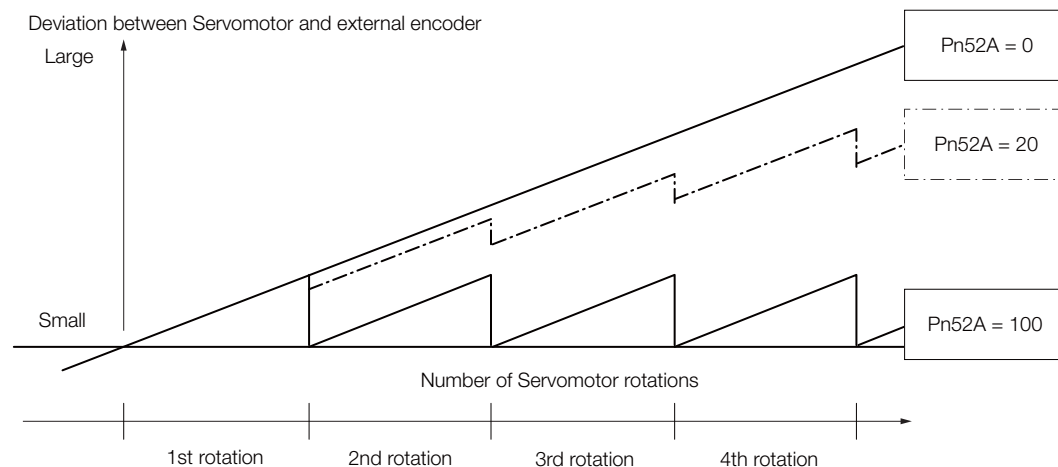

◆ Related Parameter

Pn52A	Multiplier per Fully-closed Rotation				
	Setting Range	Setting Unit	Default Setting	When Enabled	Classification
	0 to 100	1%	20	Immediately	Setup

10.3.7 Analog Monitor Signal Settings

You can monitor the position deviation between the Servomotor and load with an analog monitor.

Parameter		Name	Meaning	When Enabled	Classification
Pn006	n.□□07	Analog Monitor 1 Signal Selection	Position deviation between motor and load (output unit: 0.01 V/reference unit).	Immediately	Setup
Pn007	n.□□07	Analog Monitor 2 Signal Selection	Position deviation between motor and load (output unit: 0.01 V/reference unit).		

10.3.8 Setting to Use an External Encoder for Speed Feedback

For fully-closed loop control, you normally set a parameter to specify using the motor encoder speed (Pn22A = n.0□□□).

If you will use a Direct Drive Servomotor and a high-resolution external encoder, set the parameter to specify using the speed of the external encoder (Pn22A = n.1□□□).

Parameter		Meaning	When Enabled	Classification
Pn22A	n.0□□□ (default setting)	Use motor encoder speed.	After restart	Setup
	n.1□□□	Use external encoder speed.		

Note: This parameter cannot be used if Pn002 is set to n.0□□□ (Do not use external encoder).

Safety Functions

11

This chapter provides detailed information on the safety functions of the SERVOPACK.

11.1	Introduction to the Safety Functions	11-2
11.1.1	Safety Functions	11-2
11.1.2	Precautions for Safety Functions	11-2
11.2	Hard Wire Base Block (HWBB)	11-3
11.2.1	Risk Assessment	11-3
11.2.2	Hard Wire Base Block (HWBB) State	11-4
11.2.3	Resetting the HWBB State	11-4
11.2.4	Detecting Errors in HWBB Signal	11-5
11.2.5	HWBB Input Signal Specifications	11-5
11.2.6	Operation without a Host Controller	11-5
11.2.7	/S-RDY (Servo Ready Output) Signal	11-6
11.2.8	/BK (Brake Output) Signal	11-6
11.2.9	Stopping Methods	11-7
11.2.10	ALM (Servo Alarm) Signal and /ALO1, /ALO2, and /ALO3 (Alarm Code Output) Signals	11-7
11.3	EDM1 (External Device Monitor)	11-8
11.3.1	EDM1 Output Signal Specifications	11-8
11.4	Applications Examples for Safety Functions . .	11-9
11.4.1	Connection Example	11-9
11.4.2	Failure Detection Method	11-9
11.4.3	Procedure	11-10
11.5	Validating Safety Functions	11-11
11.6	Connecting a Safety Function Device . . .	11-12

11.1 Introduction to the Safety Functions

11.1.1 Safety Functions

Safety functions are built into the SERVOPACK to reduce the risks associated with using the machine by protecting workers from the hazards of moving machine parts and otherwise increasing the safety of machine operation. Especially when working in hazardous areas inside guards, such as for machine maintenance, the safety function can be used to avoid hazardous moving machine parts.

Refer to the following section for information on the safety function and safety parameters.

 *Compliance with UL Standards, EU Directives, UK Regulations, and Other Safety Standards on page xxvi*



Products that display the TÜV mark on the nameplate have met the safety standards.

11.1.2 Precautions for Safety Functions

WARNING

- To confirm that the HWBB function satisfies the safety requirements of the system, you must conduct a risk assessment of the system.
Incorrect use of the safety function may cause injury.
- The Servomotor will move if there is an external force (e.g., gravity on a vertical axis) even when the HWBB function is operating. Use a separate means, such as a mechanical brake, that satisfies the safety requirements.
Incorrect use of the safety function may cause injury.
- While the HWBB function is operating, the Servomotor may move within an electric angle of 180° or less as a result of a SERVOPACK failure. Use the HWBB function for an application only after confirming that movement of the Servomotor will not result in a hazardous condition.
Incorrect use of the safety function may cause injury.
- The dynamic brake and the brake signal are not safety-related elements. You must design the system so that SERVOPACK failures will not cause a hazardous condition while the HWBB function is operating.
Incorrect use of the safety function may cause injury.
- Connect devices that satisfy the safety standards for the signals for safety functions.
Incorrect use of the safety function may cause injury.
- The HWBB function does not shut OFF the power to the SERVOPACK or electrically isolate it. Implement measures to shut OFF the power supply to the SERVOPACK before you perform maintenance on it.
There is a risk of electric shock.

11.2 Hard Wire Base Block (HWBB)

A hard wire base block (abbreviated as HWBB) is a safety function that is designed to shut OFF the current to the Servomotor with a hardwired circuit.

The drive signals to the Power Module that controls the motor current are controlled by the circuits that are independently connected to the two input signal channels to turn OFF the Power Module and shut OFF the motor current.



Important

For safety function signal connections, the input signal is the 0-V common and the output signal is a source output.

This is opposite to other signals described in this manual.

To avoid confusion, the ON and OFF status of signals for the safety function are defined as follows:

ON: The state in which the relay contacts are closed or the transistor is ON and current flows into the signal line.

OFF: The state in which the relay contacts are open or the transistor is OFF and no current flows into the signal line.

The input signal uses the 0-V common. The following figure shows a connection example.

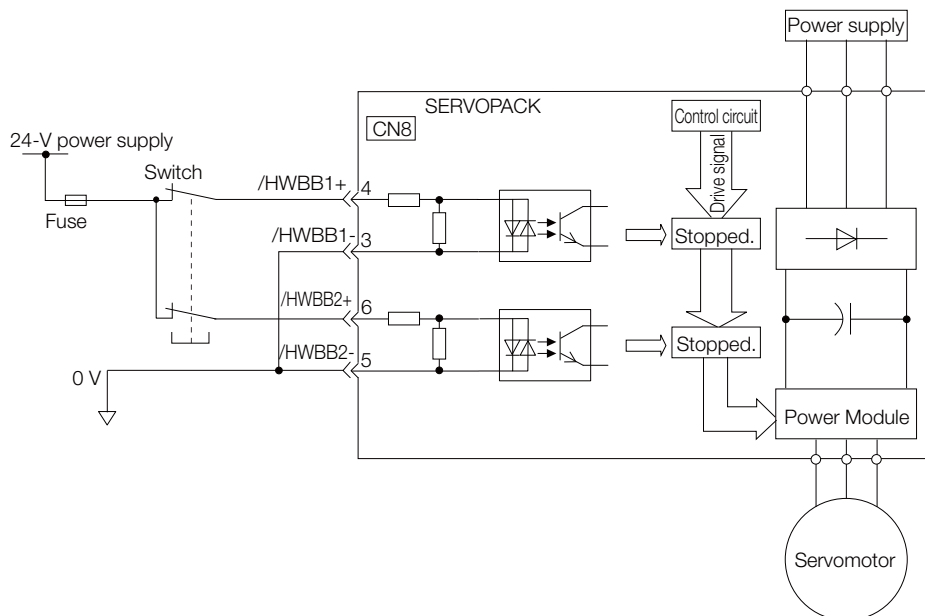

11.2.1 Risk Assessment

When using the HWBB, you must perform a risk assessment of the servo system in advance to confirm that the safety level of the standards is satisfied. Refer to the following section for details on the standards.

Compliance with UL Standards, EU Directives, UK Regulations, and Other Safety Standards on page xxvi

Note: To meet performance level e (PLe) in EN ISO 13849-1 and SIL3 in IEC 61508, the EDM1 signal must be monitored by the host controller. If the EDM1 signal is not monitored by the host controller, the level will be safety performance level c (PLc) and SIL1.

The following hazards exist even when the HWBB is operating. These hazards must be included in the risk assessment.

- The Servomotor will move if an external force is applied to it (for example, gravity on a vertical axis). Implement measures to hold the Servomotor, such as installing a separate mechanical brake.
- If a failure occurs such as a Power Module failure, the Servomotor may move within an electric angle of 180°. Ensure safety even if the Servomotor moves.
 - Rotary Servomotor: 1/6 rotation max. (rotational angle calculated at the motor shaft)

- Direct Drive Servomotor: 1/20 rotation max. (rotational angle calculated at the motor shaft)
- Linear Servomotor: 50 mm max.
- The HWBB does not shut OFF the power to the SERVOPACK or electrically isolate it. Implementation measures to shut OFF the power supply to the SERVOPACK before you perform maintenance on it.

11.2.2 Hard Wire Base Block (HWBB) State

The SERVOPACK will be in the following state if the HWBB operates. If the /HWBB1 or /HWBB2 signal turns OFF, the HWBB will operate and the SERVOPACK will enter a HWBB state.

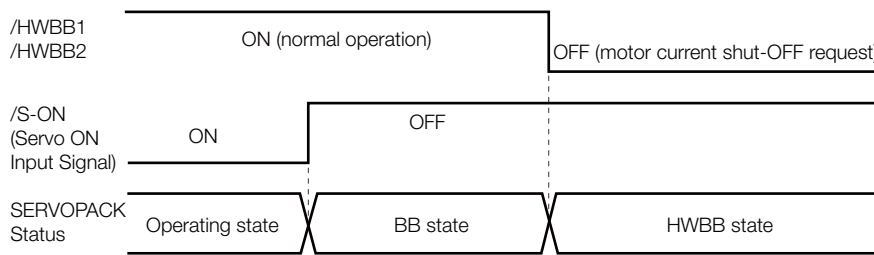

11.2.3 Resetting the HWBB State

Normally, after the /S-ON (Servo ON) signal is turned OFF and power is no longer supplied to the Servomotor, the /HWBB1 and /HWBB2 signals will turn OFF and the SERVOPACK will enter the HWBB state. If you turn ON the /HWBB1 and /HWBB2 signals in this state, the SERVOPACK will enter a base block (BB) state and will be ready to acknowledge the /S-ON signal.

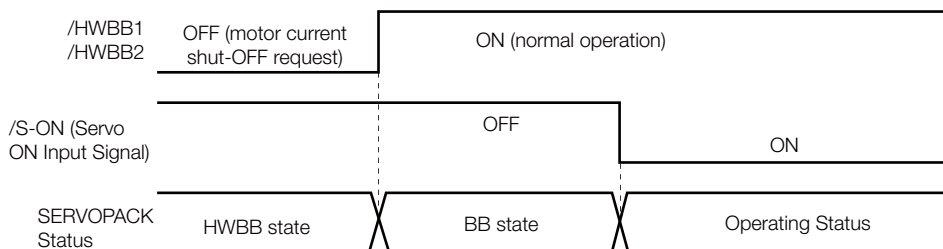

If the /HWBB1 and /HWBB2 signals are OFF and the /S-ON (Servo ON Input) signal is input, the HWBB state will be maintained even after the /HWBB1 and /HWBB2 signals are turned ON. Turn OFF the /S-ON signal to place the SERVOPACK in the BB state and then turn ON the /S-ON signal again.

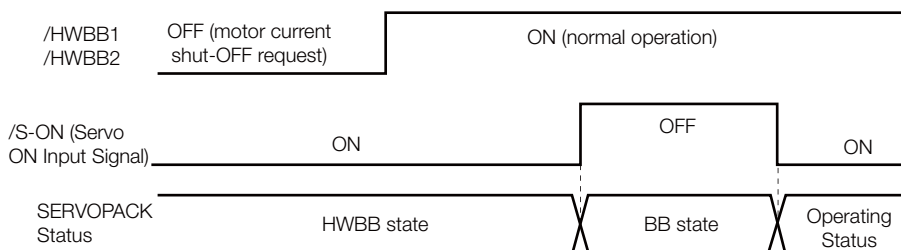

- Note: 1. If the SERVOPACK is placed in the BB state while the main circuit power supply is OFF, the HWBB state will be maintained until the /S-ON (Servo ON) signal is turned OFF.
2. If the /S-ON (Servo ON) signal is set to be always active (Pn50A = n.□□7□), you cannot reset the HWBB state. Do not set this value if you are using the HWBB.

11.2.4 Detecting Errors in HWBB Signal

If only the /HWBB1 or the /HWBB2 signal is input, an A.Eb1 alarm (Safety Function Signal Input Timing Error) will occur unless the other signal is input within 10 seconds. This makes it possible to detect failures, such as disconnection of an HWBB signal.

⚠ CAUTION

- The A.Eb1 alarm (Safety Function Signal Input Timing Error) is not a safety-related element. Keep this in mind when you design the system.

11.2.5 HWBB Input Signal Specifications

If an HWBB is requested by turning OFF the two HWBB input signal channels (/HWBB1 and /HWBB2), the power supply to the Servomotor will be turned OFF within 8 ms.

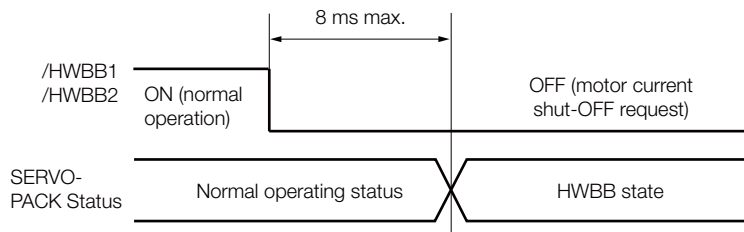

Note: 1. The OFF status is not recognized if the OFF interval of the /HWBB1 or /HWBB2 signal is 0.5 ms or shorter.
 2. You can check the status of the input signals by using monitor displays.

11.2.6 Operation without a Host Controller

The HWBB will operate even for operation without a host controller.

However, if the HWBB operates during execution of the following functions, leave the execution mode for the function and then enter it again to restart operation. Operation will not be restarted simply by turning OFF the /HWBB1 and /HWBB2 signals.

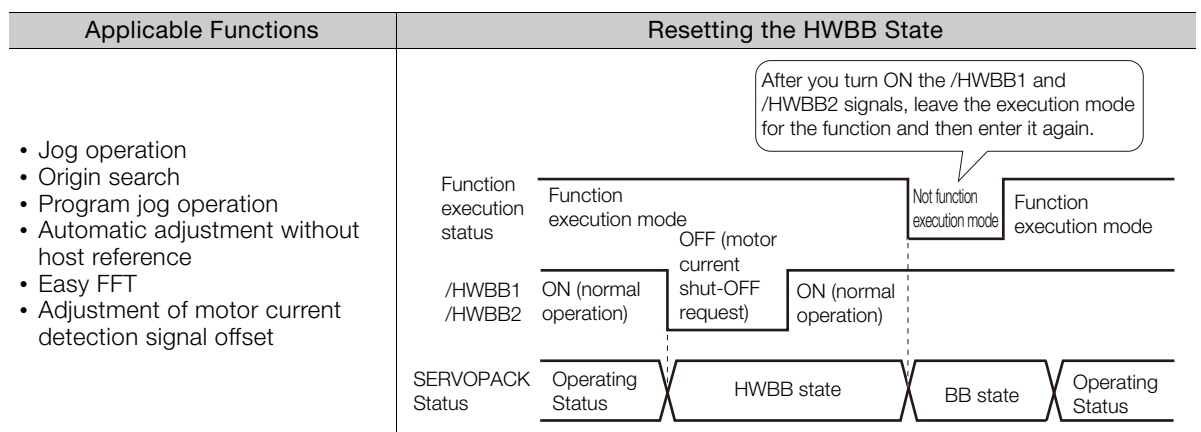

11.2.7 /S-RDY (Servo Ready Output) Signal

The /S-ON (Servo ON) signal will not be acknowledged in the HWBB state. Therefore, the Servo Ready Output Signal will turn OFF. The Servo Ready Output Signal will turn ON if both the /HWBB1 and /HWBB2 signals are ON and the /S-ON signal is turned OFF (BB state).

The following example is for when a servo alarm does not occur when the main circuit power supply is turned ON.

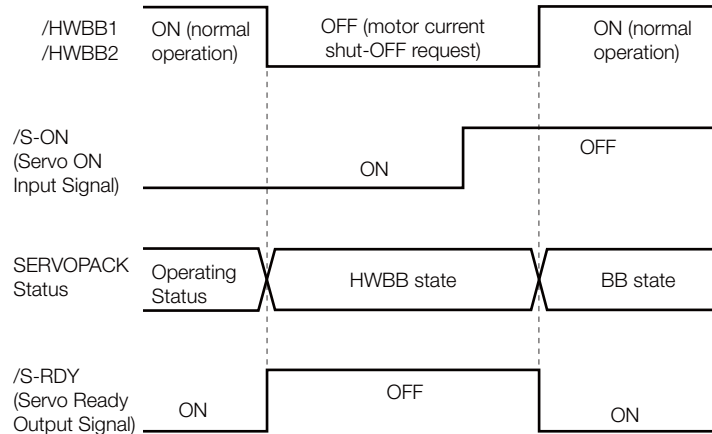

11.2.8 /BK (Brake Output) Signal

If the HWBB operates when the /HWBB1 or /HWBB2 signal is OFF, the /BK (Brake) signal will turn OFF. At that time, the setting in Pn506 (Brake Reference - Servo OFF Delay Time) will be disabled. Therefore, the Servomotor may be moved by external force until the actual brake becomes effective after the /BK signal turns OFF.

CAUTION

- The brake signal is not a safety-related element. You must design the system so that a hazardous condition does not occur even if the brake signal fails in the HWBB state. Also, if a Servomotor with a Brake is used, keep in mind that the brake in the Servomotor is used only to prevent the moving part from being moved by gravity or an external force and it cannot be used to stop the Servomotor.

11.2.9 Stopping Methods

If the /HWBB1 or /HWBB2 signal turns OFF and the HWBB operates, the Servomotor will stop according to the stop mode that is set for stopping the Servomotor when the servo turns OFF (Pn001 = n.□□□X). However, if the dynamic brake is enabled (Pn001 = n.□□□0 or n.□□□1), observe the following precautions.

CAUTION

- The dynamic brake is not a safety-related element. You must design the system so that a hazardous condition does not occur even if the Servomotor coasts to a stop in the HWBB state. Normally, we recommend that you use a sequence that returns to the HWBB state after stopping for a reference.
- If the application frequently uses the HWBB, stopping with the dynamic brake may result in the deterioration of elements in the SERVOPACK. To prevent internal elements from deteriorating, use a sequence in which the HWBB state is returned to after the Servomotor has come to a stop.

11.2.10 ALM (Servo Alarm) Signal and /ALO1, /ALO2, and /ALO3 (Alarm Code Output) Signals

The ALM (Servo Alarm) signal and the /ALO1, /ALO2, and /ALO3 (Alarm Code Output) signals are not output in the HWBB state.

11.3 EDM1 (External Device Monitor)

The EDM1 (External Device Monitor) signal is used to monitor failures in the HWBB. Connect the monitor signal as a feedback signal, e.g., to the Safety Unit.

Note: To meet performance level e (PLe) in EN ISO 13849-1 and SIL3 in IEC 61508, the EDM1 signal must be monitored by the host controller. If the EDM1 signal is not monitored by the host controller, the level will be safety performance level c (PLc) and SIL1.

• **Failure Detection Signal for EDM1 Signal**

The relationship between the EDM1, /HWBB1, and /HWBB2 signals is shown below.

Detection of failures in the EDM1 signal circuit can be achieved by using the status of the /HWBB1, /HWBB2, and EDM1 signals in the following table. A failure can be detected by checking the failure status, e.g., when the power supply is turned ON.

Signal	Logic			
/HWBB1	ON	ON	OFF	OFF
/HWBB2	ON	OFF	ON	OFF
EDM1	OFF	OFF	OFF	ON

WARNING

- The EDM1 signal is not a safety output. Use it only for monitoring for failures.

11.3.1 EDM1 Output Signal Specifications

If an HWBB is requested by turning OFF the two HWBB input signal channels (/HWBB1 and /HWBB2) when the safety function is operating normally, the EDM1 output signal will be turned ON within 8 ms.

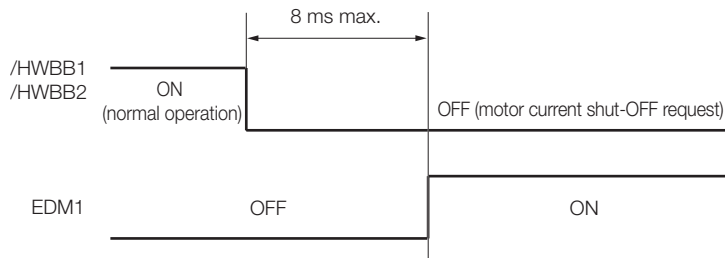

11.4 Applications Examples for Safety Functions

This section provides examples of using the safety functions.

11.4.1 Connection Example

In the following example, a Safety Unit is used and the HWBB operates when the guard is opened.

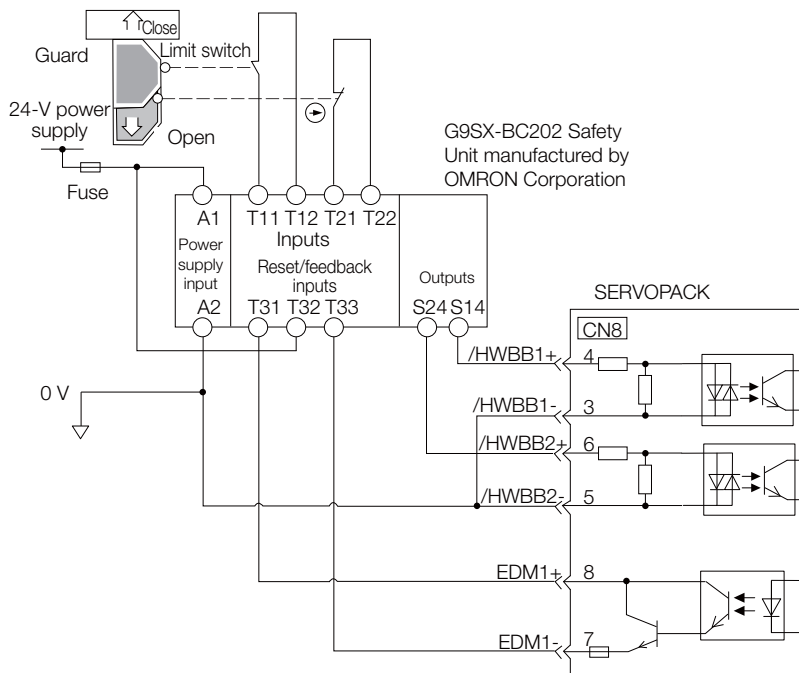

When the guard is opened, both the /HWBB1 and the /HWBB2 signals turn OFF, and the EDM1 signal turns ON. Because the feedback circuit is ON while the guard is closed, the Safety Unit is reset, the /HWBB1 and the /HWBB2 signals turn ON, and the operation is enabled.

Note: The EDM1 signal is used as a source output. Connect the EDM1 so that the current flows from EDM1+ to EDM1-.

11.4.2 Failure Detection Method

If a failure occurs (e.g., the /HWBB1 or the /HWBB2 signal remains ON), the Safety Unit is not reset when the guard is closed because the EDM1 signal remains OFF. Therefore starting is not possible and a failure is detected.

In this case the following must be considered: an error in the external device, disconnection of the external wiring, short-circuiting in the external wiring, or a failure in the SERVOPACK. Find the cause and correct the problem.

11.4.3 Procedure

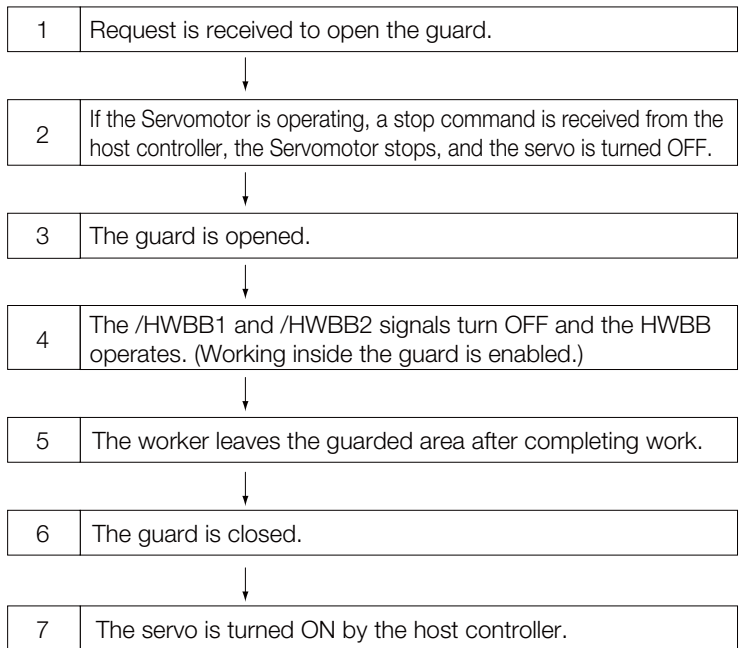

11.5 Validating Safety Functions

When you commission the system or perform maintenance or SERVOPACK replacement, you must always perform the following validation test on the HWBB function after completing the wiring. (It is recommended that you keep the confirmation results as a record.)

- When the /HWBB1 and /HWBB2 signals turn OFF, confirm that the Digital Operator displays **Hbb** and that the Servomotor does not operate.
- Monitor the ON/OFF status of the /HWBB1 and /HWBB2 signals.
If the ON/OFF status of the signals do not coincide with the display, the following must be considered: an error in the external device, disconnection of the external wiring, short-circuiting in the external wiring, or a failure in the SERVOPACK. Find the cause and correct the problem.
- Confirm that the EDM1 signal is OFF while in normal operation by using the feedback circuit input display of the connected device.

11.6 Connecting a Safety Function Device

Use the following procedure to connect a safety function device.

1. Remove the Safety Jumper Connector from the connector for the safety function device (CN8).

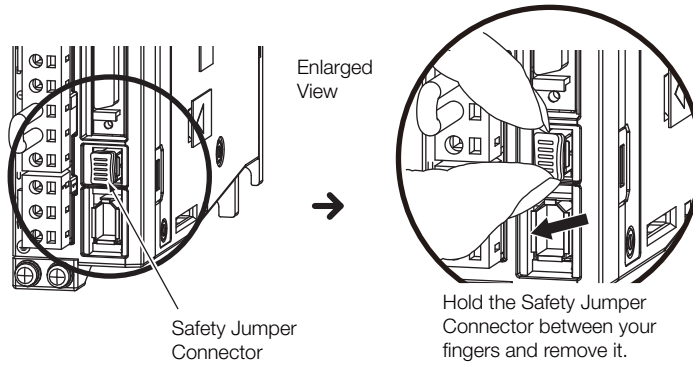

2. Connect the safety function device to the connector for the safety function device (CN8).

Note: If you do not connect a safety function device, leave the Safety Jumper Connector connected to the connector for the safety function device (CN8). If the SERVOPACK is used without the Safety Jumper Connector connected to CN8, no current will be supplied to the Servomotor and no motor torque will be output. In this case, **Hbb** will be displayed on the Digital Operator.

Settings for the INDEXER Module

12

This chapter provides detailed information on the moving mode and coordinate settings, reference settings, and origin settings.

12.1 Moving Mode and Coordinate Settings . . 12-2

- 12.1.1 When the Coordinates are the Linear Type 12-2
- 12.1.2 When the Coordinates are the Rotary Type 12-3

12.2 Settings for References 12-4

- 12.2.1 Motor Speed 12-4
- 12.2.2 Acceleration Rate and Deceleration Rate 12-4
- 12.2.3 Smoothing 12-5

12.3 Origin Settings 12-6

- 12.3.1 When Using an Absolute Encoder 12-6
- 12.3.2 When Using an Incremental Encoder 12-7

12.4 Speed/Position Expansion Function Setting . . 12-8

- 12.4.1 Parameters 12-8
- 12.4.2 Serial Commands 12-8
- 12.4.3 Program Tables, ZONE Tables, and JOG Speed Tables 12-9
- 12.4.4 Parameter Editing Commands 12-11
- 12.4.5 Monitor Commands 12-11
- 12.4.6 Digital Operator Displays 12-12

12.1 Moving Mode and Coordinate Settings

Use the following parameters to set the moving mode and the coordinates.

Parameter		Meaning	When Enabled	Classification	
PnB20	0 (default setting)	Sets coordinates to linear type.	After restart	Setup	
	1	Sets coordinates to rotary type. Moving mode is set as shortest path.			
	2	Sets coordinates to rotary type. Moving mode is always set as forward.			
	3	Sets coordinates to rotary type. Moving mode is always set as reverse.			
PnB21	<ul style="list-style-type: none"> Linear coordinates (PnB20 = 0): Forward Software Limit (P-LS) Rotational coordinates (PnB20 ≠ 0): Last Rotational Coordinate 				
	Setting Range	Setting Unit	Default Setting	When Enabled	Classification
	-99,999,999 to 99,999,999*	1 reference unit	99,999,999	After restart	Setup
PnB23	<ul style="list-style-type: none"> Linear coordinates (PnB20 = 0): Reverse Software Limit (N-LS) Rotational coordinates (PnB20 ≠ 0): First Rotational Coordinate 				
	Setting Range	Setting Unit	Default Setting	When Enabled	Classification
	-99,999,999 to 99,999,999*	1 reference unit	-99,999,999	After restart	Setup
PnB25	<ul style="list-style-type: none"> When using an incremental encoder: Origin When using an absolute encoder: Absolute Encoder Offset 				
	Setting Range	Setting Unit	Default Setting	When Enabled	Classification
	-99,999,999 to 99,999,999*	1 reference unit	0	After restart	Setup

* If you set PnB54 to 1 (Enable Expansion Mode), the parameter setting range will change. Refer to the following section for details.

 12.4 Speed/Position Expansion Function Setting on page 12-8

12.1.1 When the Coordinates are the Linear Type

When using the linear type coordinates such as with a ball screw, set PnB20 to 0 and set the forward software limit (P-LS) in PnB21 and the reverse software limit (N-LS) in PnB23.

An error will occur if the positioning target position exceeds one of the software limits.

An error will also occur if +/-INFINITE is set for the target position (POS) in the program table.

If the Servomotor reaches a software limit while a jog command is being sent or during jog speed table operation, the Servomotor will stop at the deceleration rate set in PnB2B.

If both PnB21 and PnB23 are set to 0, the software limit function will be disabled.

The software limit function is enabled after completion of homing. If, however, PnB31 is set to 0 (no homing), the software limit function will be enabled when the control power supply is turned ON. The software limit function will also be enabled as soon as the ZSET serial command is executed.



12.1.2 When the Coordinates are the Rotary Type

When using a rotary type coordinates such as with a rotary table, set PnB20 to 1 (shortest path), to 2 (forward), or to 3 (reverse). Then set the end point of rotational coordinates in PnB21 and the starting point of rotational coordinates in PnB23.

The software limit function will be disabled.

If PnB20 is set to 1 (shortest path), the motor will rotate in the shortest direction (forward or reverse) when the target position is specified as an absolute position.

If PnB20 is set to 2 (forward), the motor will always rotate in the forward direction when the target position is specified as an absolute position.

If PnB20 is set to 3 (reverse), the motor will always rotate in the reverse direction when the target position is specified as an absolute position.

If the target position is specified as an relative position, the motor will rotate in the specified direction regardless of the setting of PnB20.

Example • PnB21 = +3599, PnB23 = 0

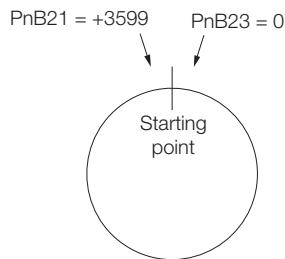

• PnB21 = +4999, PnB23 = -5000

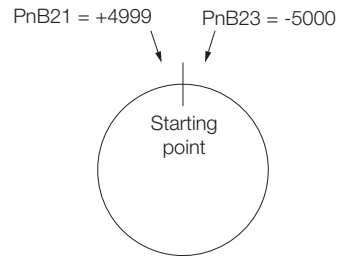

Even when equipment like a rotary table is used, if multiple turns cannot be performed set the coordinate as linear type (PnB20 = 0).

In this case, the values set in PnB21 and PnB23 are the values of the soft limits.



Important

When using rotary type coordinates and an absolute encoder, set the multiturn limit (Pn205). Refer to the following section for information on the multiturn limit settings.

 [6.7.2 Multiturn Limit Setting](#) on page 6-25

12.2 Settings for References

12.2.1 Motor Speed

For program table operation, the positioning speed is registered in SPD and the registration speed is registered in RSPD. For jog speed table operation, the jog speed is registered in JSPD.

For operation with serial command communications, the positioning speed is specified with the SPD command and the registration speed is specified with the RSPD command. You can omit the SPD command or PSPD command. If you do, the setting of the following PnB27 parameter (Positioning/Registration Speed) is used.

The speed is set in units of 1,000 reference units/min.

PnB27	Positioning/Registration Speed				
	Setting Range	Setting Unit	Default Setting	When Enabled	Classification
	1 to 99,999,999*	1,000 reference units/min	1,000	After restart	Setup

* If you set PnB54 to 1 (Enable Expansion Mode), the range will be 1 to 199,999,999. Refer to the following section for details.

 12.4 Speed/Position Expansion Function Setting on page 12-8

Example The following calculation applies if the reference unit is 0.01 mm and the positioning speed is 15 m/min.

$$\frac{15,000 \text{ mm/min}}{0.01 \text{ mm}} = 1,500,000 \text{ reference units/min}$$

Thus, the positioning speed setting is 1,500 [1,000 reference units/min].

12.2.2 Acceleration Rate and Deceleration Rate

For program table operation, the acceleration rate is set in ACC and the deceleration rate is set in DEC.

For jog speed table operation or operation with serial communications, the settings of the following PnB29 parameter (Acceleration Rate) and PnB2B parameter (Deceleration Rate) are used.

In serial command communications, the ACC command sets PnB29 (Acceleration Rate) and the DEC command sets PnB2B (Deceleration Rate).

The acceleration and deceleration rates are set in units of 1,000 reference units/min/ms.

PnB29	Acceleration Rate				
	Setting Range	Setting Unit	Default Setting	When Enabled	Classification
	1 to 99,999,999*	1,000 (reference units/min)/ms	1,000	Immediately	Setup

PnB2B	Deceleration Rate				
	Setting Range	Setting Unit	Default Setting	When Enabled	Classification
	1 to 99,999,999*	1,000 (reference units/min)/ms	1,000	Immediately	Setup

* If you set PnB54 to 1 (Enable Expansion Mode), the parameter setting range will change. Refer to the following section for details.

 12.4 Speed/Position Expansion Function Setting on page 12-8

Example The following calculation applies if the reference unit is 0.01 mm and the acceleration time from 0 m/min to 15 m/min is 100 ms.

$$\frac{15,000 \text{ mm/min}}{0.01 \text{ mm}} = 1,500,000 \text{ reference units/min}$$

$$\frac{1,500,000 \text{ reference units/min}}{100 \text{ ms}} = 15,000 \text{ [(reference units/min)/ms]}$$

Thus, the acceleration setting is 15 [1,000 reference units/min].



Important

Set the acceleration and deceleration so that the values of the two settings do not differ greatly. If they differ greatly, the machine will not accelerate in accordance with the settings. For example, if PnB29 is set to 99999999 and PnB2B is set to 1, then the machine's performance will be unpredictable.

12.2.3 Smoothing

Smoothing allows you to apply a filter to the position reference to produce smoother Servomotor acceleration and deceleration.

Note: Smoothing does not affect the travel distance.

The following parameters are related to smoothing.

Pn217	Average Position Reference Movement Time				
	Setting Range	Setting Unit	Default Setting	When Enabled	Classification
	0 to 10,000	0.1 ms	0*	Immediately after the motor stops	Setup

* The filter is disabled if you set the parameter to 0.

Note: Change the setting only when the Servomotor is stopped.

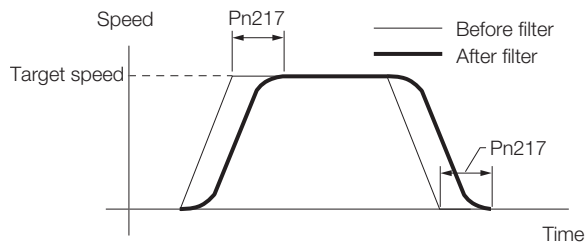

12.3 Origin Settings

It is necessary to define a reference position to operate a device or machine. This is done with origin settings.

The origin settings depend on whether an absolute encoder or an incremental encoder is used.

12.3.1 When Using an Absolute Encoder

If you use an absolute encoder, it is not necessary to set the origin every time the power supply to the equipment is turned ON.

However, when you set up the equipment, you must set PnB25 to the offset between the origin of the absolute encoder and the position of the origin of the reference coordinate system (called the machine coordinate system).

When you start a system that uses an absolute encoder, you must initialize the absolute encoder and adjust the position of the machine origin. Then you must set the offset that defines the origin of the reference coordinates.

PnB25	<ul style="list-style-type: none"> When using an incremental encoder: Origin When using an absolute encoder: Absolute Encoder Offset 				
	Setting Range	Setting Unit	Default Setting	When Enabled	Classification
	-99,999,999 to 99,999,999*	1 reference unit	0	After restart	Setup

* If you set PnB54 to 1 (Enable Expansion Mode), the range will be -1,073,741,823 to +1,073,741,823. Refer to the following section for details.

 12.4 Speed/Position Expansion Function Setting on page 12-8

Perform one of the following operations to set the offset.

- Execute the ZSET serial command.
- Execute utility function FnB09.
- Calculate the value and set it in PnB25.

The relationship between the origin of the absolute encoder and the machine origin coordinate system is shown in the following figure. Use the following formula to find a new absolute encoder offset.

$$PnB25 = \text{Current PnB25} + N - P$$

N: Current position of machine in new reference coordinate system
 If this position is to be defined as the origin, then normally N is 0.

P: Current position of machine in current reference coordinate system
 You can use the PON or MON1 serial command (described later) to monitor this value.

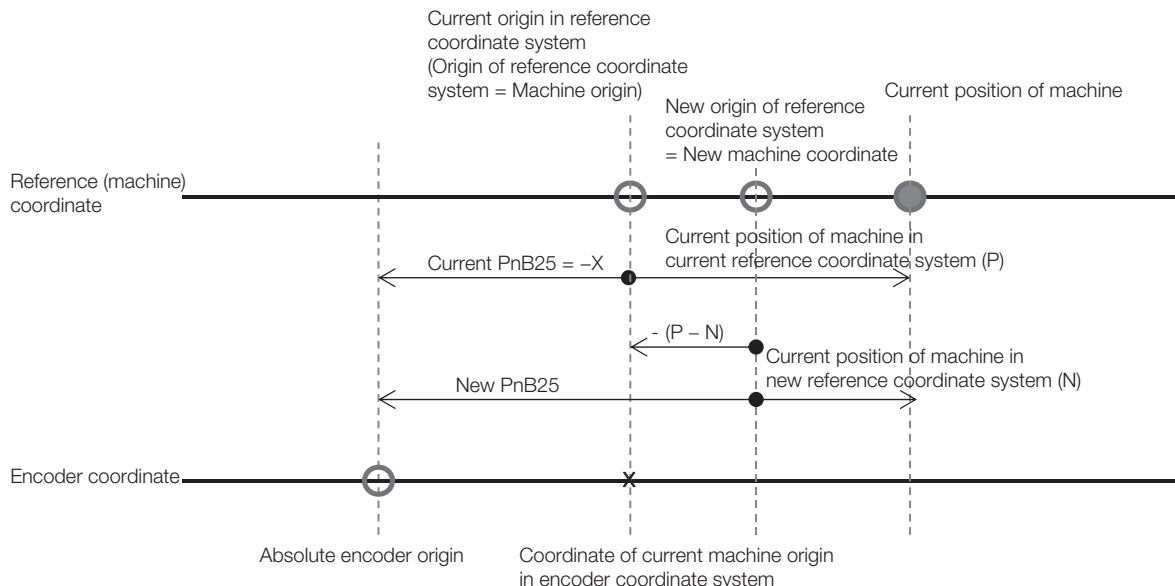

When using the linear type coordinate (PnB20 = 0), set the calculated value in PnB25.

When using a rotary type coordinate (PnB20 ≠ 0), set the results in PnB25 after performing the following calculations so that the following relationships are satisfied: $PnB23 \leq PnB25 \leq PnB21$.

- If the results is smaller than PnB23 (the starting point of the rotational coordinates), add the width of the coordinates ($PnB21 - PnB23 + 1$).
- If the results is larger than PnB21 (the end point of the rotational coordinates), subtract the width of the coordinates ($PnB21 - PnB23 + 1$).

Refer to the following section for information on setting up an absolute encoder.

 5.15 *Resetting the Absolute Encoder* on page 5-48



You must define the origin again if you change the settings of any of the following parameters: Pn20E, Pn210, Pn205, PnB20, or PnB25. Always turn the power supply OFF and ON again before you set the origin to enable changes to these parameters.

12.3.2 When Using an Incremental Encoder

If you use an incremental encoder, you must set the origin every time the power supply to the equipment is turned ON.

Homing is used to define the machine origin. Refer to the following section for details on homing.

 13.2 *Homing* on page 13-4

The setting of PnB25 is set as the current value when the power supply is turned ON or when homing is completed.

PnB25	<ul style="list-style-type: none"> • When using an incremental encoder: Origin • When using an absolute encoder: Absolute Encoder Offset 				
	Setting Range	Setting Unit	Default Setting	When Enabled	Classification
	-99,999,999 to 99,999,999*	1 reference unit	0	After restart	Setup

* If you set PnB54 to 1 (Enable Expansion Mode), the range will be -1,073,741,823 to +1,073,741,823. Refer to the following section for details.

 12.4 *Speed/Position Expansion Function Setting* on page 12-8



WARNING

- If you are using an incremental encoder, always perform homing before you start program table operation. If you perform program table operation without performing homing, positions cannot be managed so correct positioning may not be possible. Unexpected machine operation, failure, or personal injury may occur.

12.4 Speed/Position Expansion Function Setting

The speed/position expansion function uses a 24-bit encoder to perform optimum positioning. To do so, the setting ranges are expanded for speed parameters, position parameters, and serial command data.

This function is supported for INDEXER Modules with software version 0007 or higher.

If you set PnB54 to 1 (Enable Expansion Mode), the setting ranges for parameters, serial commands, and program tables, the number of display digits for monitor commands, and the number of display digits on the Digital Operator will be expanded. Details are provided below.

12.4.1 Parameters

Parameter No.	Name	Setting Ranges	
		PnB54 = 0 (Disable Expansion Mode)	PnB54 = 1 (Enable Expansion Mode)
PnB21	<ul style="list-style-type: none"> Linear coordinates (PnB20 = 0): Forward Software Limit (P-LS) Rotational coordinates (PnB20 ≠ 0): Last Rotational Coordinate 	-99,999,999 to +99,999,999	-536,870,911 to +536,870,911
PnB23	<ul style="list-style-type: none"> Linear coordinates (PnB20 = 0): Reverse Software Limit (N-LS) Rotational coordinates (PnB20 ≠ 0): First Rotational Coordinate 	-99,999,999 to +99,999,999	-536,870,911 to +536,870,911
PnB25	<ul style="list-style-type: none"> When using an incremental encoder: Origin When using an absolute encoder: Absolute Encoder Offset 	-99,999,999 to +99,999,999	-1,073,741,823 to +1,073,741,823
PnB27	Positioning/Registration Speed	1 to 99,999,999	1 to 199,999,999
PnB29	Acceleration Rate	1 to 99,999,999	1 to 199,999,999
PnB2B	Deceleration Rate	1 to 99,999,999	1 to 199,999,999
PnB33	Homing Movement Speed	1 to 99,999,999	1 to 199,999,999
PnB35	Homing Approach Speed	1 to 99,999,999	1 to 199,999,999
PnB37	Homing Creep Speed	1 to 99,999,999	1 to 199,999,999
PnB39	Homing Final Travel Distance	-99,999,999 to +99,999,999	-1,073,741,823 to +1,073,741,823

12.4.2 Serial Commands

Speed Commands

PnB54 = 0 (Disable Expansion Mode)		PnB54 = 1 (Enable Expansion Mode)	
Serial Command	Setting Range	Serial Command	Setting Range
SPDnnnnnnnn	1 ≤ nnnnnnnn ≤ 99,999,999 [1,000 reference units/min]	SPDnnnnnnnn	1 ≤ nnnnnnnnn ≤ 199,999,999 [1,000 reference units/min]
ACCnnnnnnnn	1 ≤ nnnnnnnn ≤ 99,999,999 [1,000 (reference units/min)/ms]	ACCnnnnnnnn	1 ≤ nnnnnnnnn ≤ 199,999,999 [1,000 (reference units/min)/ms]
DECnnnnnnnn	1 ≤ nnnnnnnn ≤ 99,999,999 [1,000 (reference units/min)/ms]	DECnnnnnnnn	1 ≤ nnnnnnnnn ≤ 199,999,999 [1,000 (reference units/min)/ms]
RSPDnnnnnnnn	1 ≤ nnnnnnnn ≤ 99,999,999 [1,000 reference units/min]	RSPDnnnnnnnn	1 ≤ nnnnnnnnn ≤ 199,999,999 [1,000 reference units/min]
JOGPnnnnnnnn, JOGNnnnnnnnn	1 ≤ nnnnnnnn ≤ 99,999,999 [1,000 reference units/min]	JOGPnnnnnnnn, JOGNnnnnnnnn	1 ≤ nnnnnnnnn ≤ 199,999,999 [1,000 reference units/min]
RJOGPnnnnnnnn, RJOGNnnnnnnnn	1 ≤ nnnnnnnn ≤ 99,999,999 [1,000 reference units/min]	RJOGPnnnnnnnn, RJOGNnnnnnnnn	1 ≤ nnnnnnnnn ≤ 199,999,999 [1,000 reference units/min]

Position Commands

PnB54 = 0 (Disable Expansion Mode)		PnB54 = 1 (Enable Expansion Mode)	
Serial Command	Setting Range	Serial Command	Setting Range
POS (±) nnnnnnnn, POSA (±) nnnnnnnn	-99,999,999 ≤ nnnnnnnn ≤ +99,999,999 [1 reference unit]	POS (±) nnnnnnnnn, POSA (±) nnnnnnnnn	-1,073,741,823 ≤ nnnnnnnnn ≤ +1,073,741,823 [1 reference unit]
POSI (±) nnnnnnnn	-99,999,999 ≤ nnnnnnnn ≤ +99,999,999 [1 reference unit]	POSI (±) nnnnnnnnn	-1,073,741,823 ≤ nnnnnnnnn ≤ +1,073,741,823 [1 reference unit]
ST (±) nnnnnnnn, STA (±) nnnnnnnn	-99,999,999 ≤ nnnnnnnn ≤ +99,999,999 [1 reference unit]	ST (±) nnnnnnnn, STA (±) nnnnnnnn	-1,073,741,823 ≤ nnnnnnnnn ≤ +1,073,741,823 [1 reference unit]
STI (±) nnnnnnnn	-99,999,999 ≤ nnnnnnnn ≤ +99,999,999 [1 reference unit]	STI (±) nnnnnnnn	-1,073,741,823 ≤ nnnnnnnnn ≤ +1,073,741,823 [1 reference unit]
RDSTnnnnnnn	0 ≤ nnnnnnnn ≤ 99,999,999 [1 reference unit]	RDSTnnnnnnn	0 ≤ nnnnnnnn ≤ 1,073,741,823 [1 reference unit]
RS (±) nnnnnnnn, RSA (±) nnnnnnnn	-99,999,999 ≤ nnnnnnnn ≤ +99,999,999 [1 reference unit]	RS (±) nnnnnnnn, RSA (±) nnnnnnnnn	-1,073,741,823 ≤ nnnnnnnnn ≤ +1,073,741,823 [1 reference unit]
RSI (±) nnnnnnnn	-99,999,999 ≤ nnnnnnnn ≤ +99,999,999 [1 reference unit]	RSI (±) nnnnnnnn	-1,073,741,823 ≤ nnnnnnnnn ≤ +1,073,741,823 [1 reference unit]
ZSET (±) nnnnnnnn	-99,999,999 ≤ nnnnnnnn ≤ +99,999,999 [1 reference unit]	ZSET (±) nnnnnnnnn	-1,073,741,823 ≤ nnnnnnnnn ≤ +1,073,741,823 [1 reference unit]

12.4.3 Program Tables, ZONE Tables, and JOG Speed Tables

Program Tables

◆ Write Commands

PnB54 = 0 (Disable Expansion Mode)		PnB54 = 1 (Enable Expansion Mode)	
Serial Command	Setting Range	Serial Command	Setting Range
POSTsss = nnnnnnn	Annnnnnnn: Absolute position [1 reference unit] (-99,999,999 ≤ nnnnnnnn ≤ +99,999,999) Innnnnnnn: Relative distance [1 reference unit] (-99,999,999 ≤ nnnnnnnn ≤ +99,999,999) Snnnnnnn: Consecutive stop [1 reference unit] (-99,999,999 ≤ nnnnnnnn ≤ +99,999,999)	POSTsss = nnnnnnnnn	Annnnnnnnnn: Absolute position [1 reference unit] (-1,073,741,823 ≤ nnnnnnnnnn ≤ +1,073,741,823) Innnnnnnnnn: Relative distance [1 reference unit] (-1,073,741,823 ≤ nnnnnnnnnn ≤ +1,073,741,823) Snnnnnnnnnn: Consecutive stop [1 reference unit] (-1,073,741,823 ≤ nnnnnnnnnn ≤ +1,073,741,823)
SPDTsss = nnnnnnnn	1 ≤ nnnnnnnn ≤ 99,999,999 [1,000 reference units/min]	SPDTsss = nnnnnnnnn	1 ≤ nnnnnnnnnn ≤ 199,999,999 [1,000 reference units/min]
RDSTsss = nnnnnnnn	0 ≤ nnnnnnnn ≤ 99,999,999 [1 reference unit]	RDSTsss = nnnnnnnnnn	0 ≤ nnnnnnnnnn ≤ 1,073,741,823 [1 reference unit]
RSPDTsss = nnnnnnnn	1 ≤ nnnnnnnn ≤ 99,999,999 [1,000 reference units/min]	RSPDTsss = nnnnnnnnn	1 ≤ nnnnnnnnnn ≤ 199,999,999 [1,000 reference units/min]
ACCTsss = nnnnnnnn	1 ≤ nnnnnnnn ≤ 99,999,999 [1,000 (reference units/min)/ms]	ACCTsss = nnnnnnnnn	1 ≤ nnnnnnnnnn ≤ 199,999,999 [1,000 (reference units/min)/ms]

Continued on next page.

Continued from previous page.

PnB54 = 0 (Disable Expansion Mode)		PnB54 = 1 (Enable Expansion Mode)	
Serial Command	Setting Range	Serial Command	Setting Range
DECTsss = nnnnnnnn	1 ≤ nnnnnnnn ≤ 99,999,999 [1,000 (reference units/min)/ms]	DECTsss = nnnnnnnn	1 ≤ nnnnnnnn ≤ 199,999,999 [1,000 (reference units/min)/ms]

◆ Read Commands

Serial Command	Display (Acknowledgment)	
	PnB54 = 0 (Disable Expansion Mode)	PnB54 = 1 (Enable Expansion Mode)
POSTsss	POST123 = A + 12345678 [CR] [LF] POST123 = I + 12345678 [CR] [LF] POST123 = S + 12345678 [CR] [LF] POST123 = +INFINITE [SP] [CR] [LF] POST123 = STOP [SP] [SP] [SP] [SP] [SP] [SP] [CR] [LF] POST123 = -[SP] [SP] [SP] [SP] [SP] [SP] [SP] [SP] [CR] [LF]	POST123 = A + 1234567890 [CR] [LF] POST123 = I + 1234567890 [CR] [LF] POST123 = S + 1234567890 [CR] [LF] POST123 = +INFINITE [SP] [SP] [SP] [CR] [LF] POST123 = STOP [SP] [SP] [SP] [SP] [SP] [SP] [SP] [SP] [CR] [LF] POST123 = -[SP] [SP] [SP] [SP] [SP] [SP] [SP] [SP] [CR] [LF]
SPDTsss	SPDT123 = 12345678 [CR] [LF]	SPDT123 = 1234567890 [CR] [LF]
RDSTTsss	RDSTT123 = 12345678 [CR] [LF] RDSTT123 = -[SP] [SP] [SP] [SP] [SP] [SP] [SP] [SP] [CR] [LF]	RDSTT123 = 1234567890 [CR] [LF] RDSTT123 = -[SP] [SP] [SP] [SP] [SP] [SP] [SP] [SP] [CR] [LF]
RSPDTsss	RSPDT123 = 12345678 [CR] [LF]	RSPDT123 = 1234567890 [CR] [LF]
ACCTsss	ACCTsss = 12345678 [CR] [LF] ACCTsss = : [SP] [SP] [SP] [SP] [SP] [SP] [SP] [SP] [CR] [LF]	ACCTsss = 1234567890 [CR] [LF] ACCTsss = : [SP] [SP] [SP] [SP] [SP] [SP] [SP] [SP] [CR] [LF]
DECTsss	DECTsss = 12345678 [CR] [LF] DECTsss = : [SP] [SP] [SP] [SP] [SP] [SP] [SP] [SP] [CR] [LF]	DECTsss = 1234567890 [CR] [LF] DECTsss = : [SP] [SP] [SP] [SP] [SP] [SP] [SP] [SP] [CR] [LF]

ZONE Tables

◆ Write Commands

PnB54 = 0 (Disable Expansion Mode)		PnB54 = 1 (Enable Expansion Mode)	
Serial Command	Setting Range	Serial Command	Setting Range
ZONEPTzz = nnnnnnnn	-99,999,999 ≤ nnnnnnnn ≤ +99,999,999	ZONEPTzz = nnnnnnnnnn	-1,073,741,823 ≤ nnnnnnnnnn ≤ +1,073,741,823
ZONENTzz = nnnnnnnn	-99,999,999 ≤ nnnnnnnn ≤ +99,999,999	ZONENTzz = nnnnnnnnnn	-1,073,741,823 ≤ nnnnnnnnnn ≤ +1,073,741,823

◆ Read Commands

Serial Command	Display (Acknowledgment)	
	PnB54 = 0 (Disable Expansion Mode)	PnB54 = 1 (Enable Expansion Mode)
ZONEPTzz	ZONEPT123 = +12345678 [CR] [LF]	ZONEPT123 = +1234567890 [CR] [LF]
ZONENTzz	ZONENT123 = +12345678 [CR] [LF]	ZONENT123 = +1234567890 [CR] [LF]

JOG Speed Tables

◆ Write Commands

PnB54 = 0 (Disable Expansion Mode)		PnB54 = 1 (Enable Expansion Mode)	
Serial Command	Setting Range	Serial Command	Setting Range
JSPDTdd = nnnnnnnn	1 ≤ nnnnnnnn ≤ 99,999,999 [1,000 reference units/min]	JSPDTdd = nnnnnnnn	1 ≤ nnnnnnnnn ≤ 199,999,999 [1,000 reference units/min]

◆ Read Commands

Serial Command	Display (Acknowledgment)	
	PnB54 = 0 (Disable Expansion Mode)	PnB54 = 1 (Enable Expansion Mode)
JSPDTdd	JSPDT123 = 12345678 [CR] [LF]	JSPDT123 = 1234567890 [CR] [LF]

12.4.4 Parameter Editing Commands

The following table shows the maximum number of digits. The actual number of digits depends on the setting range of the written parameter.

Serial Command	
PnB54 = 0 (Disable Expansion Mode)	PnB54 = 1 (Enable Expansion Mode)
PRMppp = (±)nnnnnnnn	PRMppp = (±)nnnnnnnnnn
TRMppp = (±)nnnnnnnn	TRMppp = (±)nnnnnnnnnn

12.4.5 Monitor Commands

Serial Command	Display (Acknowledgment)	
	PnB54 = 0 (Disable Expansion Mode)	PnB54 = 1 (Enable Expansion Mode)
PUN or MON1 (Position Reference Current Position Monitor)	PUN = +12345678 [CR] [LF]	PUN = +1234567890 [CR] [LF]
PFB or MON7 (Monitor Current Position Monitor)	PFB = +12345678 [CR] [LF]	PFB = +1234567890 [CR] [LF]
POS or MON8 (Positioning Target Position Monitor)	POS = +12345678 [CR] [LF]	POS = +1234567890 [CR] [LF]
DST or MON9 (Positioning Distance Monitor)	DST = +12345678 [CR] [LF]	DST = +1234567890 [CR] [LF]
RPOS or MON10 (Registration Target Position Monitor)	RPOS = +12345678 [CR] [LF]	RPOS = +1234567890 [CR] [LF]
RDST or MON11 (Registration Distance Monitor)	RDST = 12345678 [CR] [LF]	RDST = 1234567890 [CR] [LF]
PER or MON2 (Position Deviation Monitor)	PER = +12345678 [CR] [LF]	PER = +1234567890 [CR] [LF]

12.4.6 Digital Operator Displays

If the number of display digits is exceeded when Expansion Mode is enabled, the table name will be abbreviated.

- POS (Target Position)

Display When Expansion Mode Is Disabled

BB	-	PGM	Edit	-
POS000	=	A + 1 2 3 4 5 6 7 8		
POS001	=	I + 1 2 3 4 5 6 7 8		
POS002	=	S + 1 2 3 4 5 6 7 8		
POS003	=	S T O P		



Display When Expansion Mode Is Enabled

BB	-	PGM	Edit	-
P000	=	A + 1 2 3 4 5 6 7 8 9 0		
P001	=	I + 1 2 3 4 5 6 7 8 9 0		
P002	=	S + 1 2 3 4 5 6 7 8 9 0		
P003	=	S T O P		

- RDST (Registration Distance)

Display When Expansion Mode Is Disabled

BB	-	PGM	Edit	-
RDST000	=	1 2 3 4 5 6 7 8		
RDST001	=	1 2 3 4 5 6 7 8		
RDST002	=	1 2 3 4 5 6 7 8		
RDST003	=	1 2 3 4 5 6 7 8		



Display When Expansion Mode Is Enabled

BB	-	PGM	Edit	-
RDT000	=	1 2 3 4 5 6 7 8 9 0		
RDT001	=	1 2 3 4 5 6 7 8 9 0		
RDT002	=	1 2 3 4 5 6 7 8 9 0		
RDT003	=	1 2 3 4 5 6 7 8 9 0		

- RSPD (Registration Speed)

Display When Expansion Mode Is Disabled

BB	-	PGM	Edit	-
RSPD000	=	1 2 3 4 5 6 7 8		
RSPD001	=	1 2 3 4 5 6 7 8		
RSPD002	=	1 2 3 4 5 6 7 8		
RSPD003	=	1 2 3 4 5 6 7 8		



Display When Expansion Mode Is Enabled

BB	-	PGM	Edit	-
RSP000	=	1 2 3 4 5 6 7 8 9 0		
RSP001	=	1 2 3 4 5 6 7 8 9 0		
RSP002	=	1 2 3 4 5 6 7 8 9 0		
RSP003	=	1 2 3 4 5 6 7 8 9 0		

- JSPD (JOG Speed)

Display When Expansion Mode Is Disabled

BB	-	JSPD	Edit	-
JSPD000	=	1 2 3 4 5 6 7 8		
JSPD001	=	1 2 3 4 5 6 7 8		
JSPD002	=	1 2 3 4 5 6 7 8		
JSPD003	=	1 2 3 4 5 6 7 8		



Display When Expansion Mode Is Enabled

BB	-	JSPD	Edit	-
JSP000	=	1 2 3 4 5 6 7 8 9 0		
JSP001	=	1 2 3 4 5 6 7 8 9 0		
JSP002	=	1 2 3 4 5 6 7 8 9 0		
JSP003	=	1 2 3 4 5 6 7 8 9 0		

Operation with Digital I/O

13

This chapter provides detailed information on homing, positioning with a program table, registration, constant speed operation with a jog speed table, and ZONE outputs.

13.1 Operation Functions 13-3

13.2 Homing 13-4

- 13.2.1 I/O Signals Related to Homing 13-4
- 13.2.2 Parameters Related to Homing 13-5
- 13.2.3 Homing Procedures 13-7

13.3 Program Table Operation 13-9

- 13.3.1 Types of Operation 13-9
- 13.3.2 I/O Signals Related to Program Table Operation 13-11
- 13.3.3 Parameter Related to Program Table Operation 13-12
- 13.3.4 Program Table Configuration 13-12
- 13.3.5 Settings in the Program Table 13-13
- 13.3.6 SigmaWin+ Procedures 13-14
- 13.3.7 State Transitions 13-26
- 13.3.8 Program Table Operation Examples 13-27
- 13.3.9 EVENT Examples 13-42
- 13.3.10 Output Response Times after /START-STOP Turns ON 13-43

13.4 Jog Speed Table Operation 13-44

- 13.4.1 Input Signals Related to Jog Operation 13-44
- 13.4.2 Jog Speeds 13-44
- 13.4.3 Jog Speed Table and Speed Selection
Signals 13-45
- 13.4.4 SigmaWin+ Procedures 13-45
- 13.4.5 Jog Speed Table Operation Example 13-50
- 13.4.6 Timing of Signal Changes 13-51

13.5 ZONE Outputs 13-52

- 13.5.1 ZONE Table and ZONE Signals 13-52
- 13.5.2 Parameters Related to ZONE Signals 13-54
- 13.5.3 SigmaWin+ Procedures 13-54
- 13.5.4 ZONE Output Application Example 13-61

13.1 Operation Functions

The following five operation functions are provided.

- Homing
Homing is used to define the machine origin when the power supply is turned ON to equipment that uses an incremental encoder.
Homing is not required for equipment that uses an absolute encoder because the positional relationship between the origin of the absolute encoder and the machine origin is set in a parameter.
- Positioning with a Program Table
You can register (program) positioning patterns in a table in advance and then use specifications from the host controller to specify the operation pattern to perform operation.
- Registration
If a trigger signal (/RGRT) is input from an external device during positioning, the motor will be moved for the registration distance (RDST) that is registered in the program table.
- Constant Speed Operations with a Jog Speed Table
This function supports constant-speed operation at preset jog speeds.
- ZONE Outputs
This function outputs a zone number to indicate when the motor is within a preset zone. The lower four programmable outputs are assigned.

13.2 Homing

Homing is used to define the machine origin when the power supply is turned ON to equipment that uses an incremental encoder. Turn OFF (mode 1) the /MODE 0/1 (Mode Selection Input) signal to enable performing homing. In mode 1, CN11-5 will be the /HOME (Homing Input) signal.

 **WARNING**

- If you are using an incremental encoder, always perform homing before you start program table operation. If you perform program table operation without performing homing, positions cannot be managed so correct positioning may not be possible. Unexpected machine operation, failure, or personal injury may occur.

13.2.1 I/O Signals Related to Homing

The following I/O signals are related to homing.

Input Signals Related to Homing

Input Signal	Description	Reference
/MODE 0/1	ON: Mode 0 (program table operation) OFF: Mode 1 (jog speed table operation or homing)	page 6-4
/HOME	The /HOME signal is turned ON to start homing.	page 6-5
/DEC	The /DEC signal is used to change the homing speed, but its function depends on the setting of the homing method (PnB31).	page 6-3

Output Signals Related to Homing

Output Signal	Description	Reference
/INPOSITION	This signal turns ON when the current position is within the positioning completed width of the target position (final travel distance). It also turns ON when the Servomotor stops after positioning is canceled, even if the target position was not reached.	page 6-9



Note

Homing is not performed for an absolute encoder. Therefore, error E61E (Encoder Mismatch Error) will occur if the /HOME signal turns ON.

13.2.2 Parameters Related to Homing

◆ Parameter That Specifies the Homing Method

Specify the homing method with PnB31.

Parameter		Meaning	When Enabled	Classification
PnB31	0 (default setting)	The current position when the power supply is turned ON is the origin. Homing is not executed.	After restart	Setup
	1	The /DEC signal and encoder phase C are used for performing homing.		
	2	Only the /DEC signal is used for performing homing.		
	3	Only the encoder phase C is used for performing homing.		

Note: An Illegal Homing Command Error (E5DE) will occur if homing is attempted while PnB31 is set to 0.

◆ Parameter That Specifies the Homing Direction

Specify whether to perform homing in the forward or in the reverse direction with PnB32 = n.□□□X.

Parameter		Meaning	When Enabled	Classification
PnB32	0 (default setting)	Perform homing in the forward direction.	Immediately	Setup
	1	Perform homing in the reverse direction.		

◆ Parameter That Specifies the Origin

The value specified in PnB25 will be set as the current value when homing is completed.

PnB25	Origin				
	Setting Range	Setting Unit	Default Setting	When Enabled	Classification
	-99,999,999 to 99,999,999*	1 reference unit	0	After restart	Setup

* If you set PnB54 to 1 (Enable Expansion Mode), the range will be -1,073,741,823 to +1,073,741,823. Refer to the following section for details.

 12.4 Speed/Position Expansion Function Setting on page 12-8

◆ Parameter That Specifies the Homing Movement Speed

The following parameter sets the homing movement speed.

PnB33	Homing Movement Speed				
	Setting Range	Setting Unit	Default Setting	When Enabled	Classification
	1 to 99,999,999*	1,000 reference units/min	1,000	Immediately	Setup

* If you set PnB54 to 1 (Enable Expansion Mode), the range will be 1 to 199,999,999. Refer to the following section for details.

 12.4 Speed/Position Expansion Function Setting on page 12-8

◆ **Parameter That Specifies the Homing Approach Speed**

The following parameter sets the homing approach speed for homing. Operation details, such as changing to this speed, depends on the homing method.

PnB35	Homing Approach Speed				
	Setting Range	Setting Unit	Default Setting	When Enabled	Classification
	1 to 99,999,999*	1,000 reference units/min	1,000	Immediately	Setup

* If you set PnB54 to 1 (Enable Expansion Mode), the range will be 1 to 199,999,999. Refer to the following section for details.

 12.4 Speed/Position Expansion Function Setting on page 12-8

◆ **Parameter That Specifies the Homing Creep Speed**

The following parameter sets the homing creep speed. Operation details, such as changing to this speed, depends on the homing method.

PnB37	Homing Creep Speed				
	Setting Range	Setting Unit	Default Setting	When Enabled	Classification
	1 to 99,999,999*	1,000 reference units/min	1,000	Immediately	Setup

* If you set PnB54 to 1 (Enable Expansion Mode), the range will be 1 to 199,999,999. Refer to the following section for details.

 12.4 Speed/Position Expansion Function Setting on page 12-8

◆ **Parameter That Specifies the Homing Final Travel Distance**

This parameter sets the travel distance after the motor changes to the creep speed. The stopping position when this travel is completed is set as the setting of PnB25.

If a negative value is set, the movement direction will be reversed after the motor changes to the creep speed.

PnB39	Homing Final Travel Distance				
	Setting Range	Setting Unit	Default Setting	When Enabled	Classification
	-99,999,999 to 99,999,999*	1 reference unit	0	Immediately	Setup

* If you set PnB54 to 1 (Enable Expansion Mode), the range will be -1,073,741,823 to +1,073,741,823. Refer to the following section for details.

 12.4 Speed/Position Expansion Function Setting on page 12-8

13.2.3 Homing Procedures

Homing will start when the /HOME signal turns ON. Homing will be stopped if the /HOME signal turns OFF. If the /HOME signal turns ON while homing is stopped, homing will be restarted from where it was stopped.

If a jog speed table operation is performed with the /JOGP or /JOGN signal or if the mode is changed with the /MODE 0/1 signal while homing is stopped, homing will be canceled.

When PnB31 is set to 0 (the current position when the power supply is turned ON is the origin; homing is not executed), the origin position is defined as soon as the control power supply is turned ON.

The smaller of the settings of PnB29 and PnB2B is used as the acceleration and deceleration rates for homing.

There are three different origin patterns depending on the homing method that is specified in PnB31.

The v procedure for each method is given in this section.

Using the /DEC Signal and Encoder Origin (Phase C) for Homing (PnB31 = 1)

- ① Turn ON the /HOME signal. Homing starts. The motor will rotate in the direction specified in PnB32 (Homing Direction) at the speed specified in PnB33 (Homing Movement Speed).
- ② When the /DEC signal turns ON, the motor changes to the approach speed.
- ③ When the encoder's origin signal (phase C) is detected, the motor decelerates to the creep speed.
- ④ Homing is completed after the motor moves the final travel distance. Set PnB25 to the value of the current position where the motor is stopped.

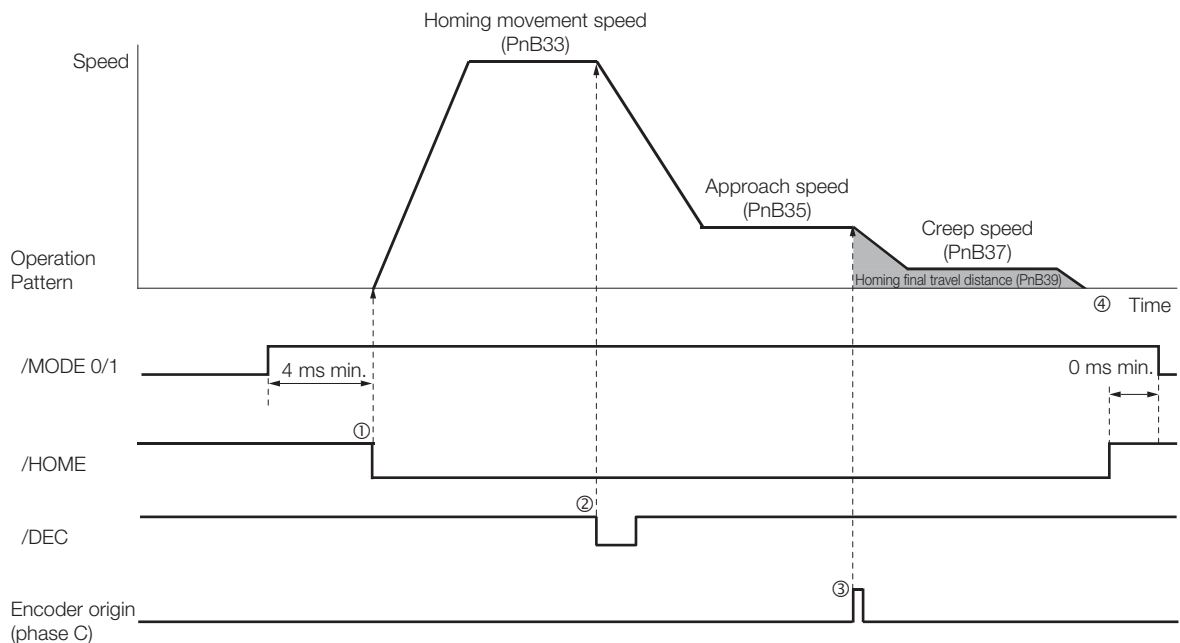

Using Only the /DEC Signal for Homing (PnB31 = 2)

- ① Turn ON the /HOME signal. Homing starts. The motor will rotate in the direction specified in PnB32 (Homing Direction) at the speed specified in PnB35 (Approach Speed).
- ② When the /DEC signal turns ON, the motor decelerates to the creep speed.
- ③ Homing is completed after the motor moves the final travel distance. Set PnB25 to the value of the current position where the motor is stopped.

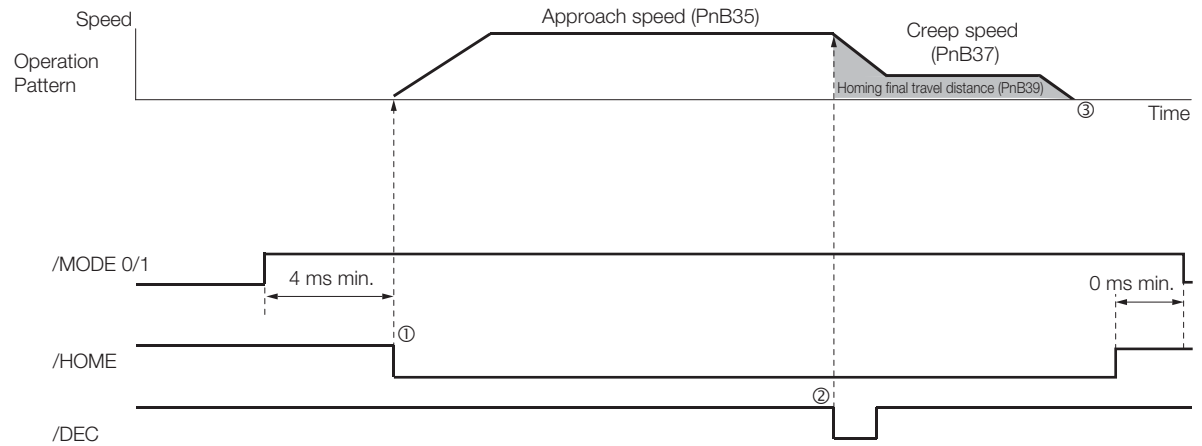

Using Only the Encoder Origin (Phase C) for the Homing (PnB31 = 3)

- ① Turn ON the /HOME signal. Homing starts. The motor will rotate in the direction specified in PnB32 (Homing Direction) at the speed specified in PnB35 (Approach Speed).
- ② When the encoder's origin signal (phase C) is detected, the motor decelerates to the creep speed.
- ③ Homing is completed after the motor moves the final travel distance. Set PnB25 to the value of the current position where the motor is stopped.

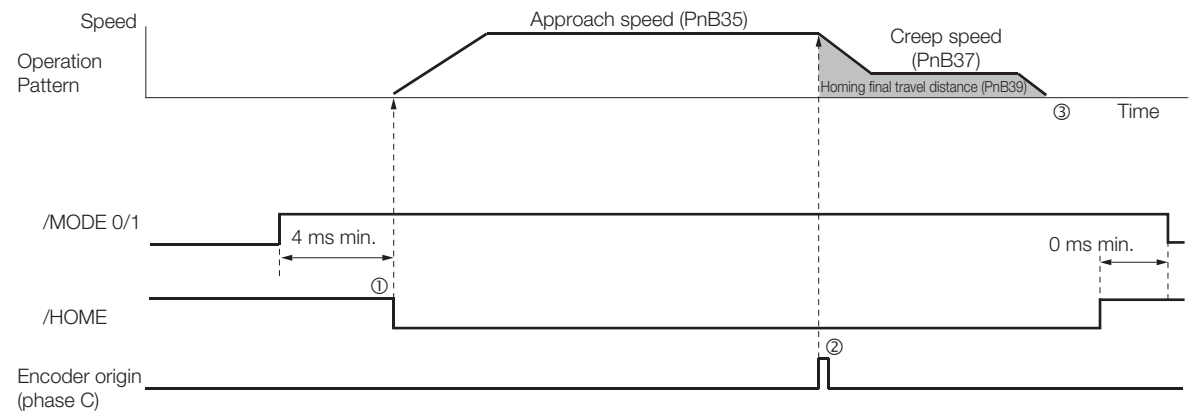

13.3 Program Table Operation

With program table operation, you can register (program) positioning patterns in a table in advance and then use commands from the host controller to specify the operation patterns to perform operation.

If you use program table operation, you do not need motion control programming in the host controller.

This section describes the types of operation that are possible, program table details, and SigmaWin+ operating procedures. It also provides examples of program table operation.

13.3.1 Types of Operation

Two types of program table operation are provided: positioning and registration.

Both types of operation are described in the rest of this section.



Note

This section describes program table operation using the item names and symbols that are registered in the program table. Refer to the following section for detailed information on the names and symbols.

13.3.5 Settings in the Program Table on page 13-13

Positioning

For positioning, the target positions are specified as the target positions (POS) in the program table. The motor is moved to the current target position.

Positioning is illustrated conceptually in the following figure.

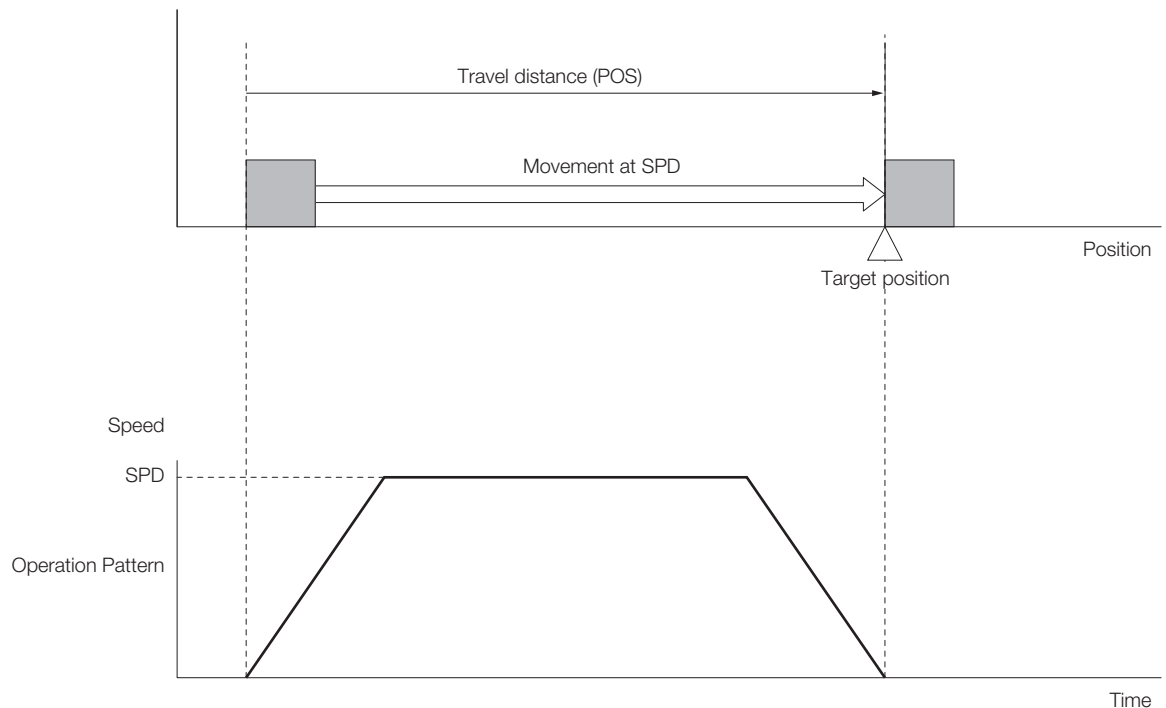

Registration Operation

If an external trigger signal (/RGRT) is input during travel (i.e., during positioning) toward a target position that is specified as the target position (POS) in the program table, the motor will move the registration distance (RDST) that is specified in the program table.

Registration operation is illustrated conceptually in the following figure.

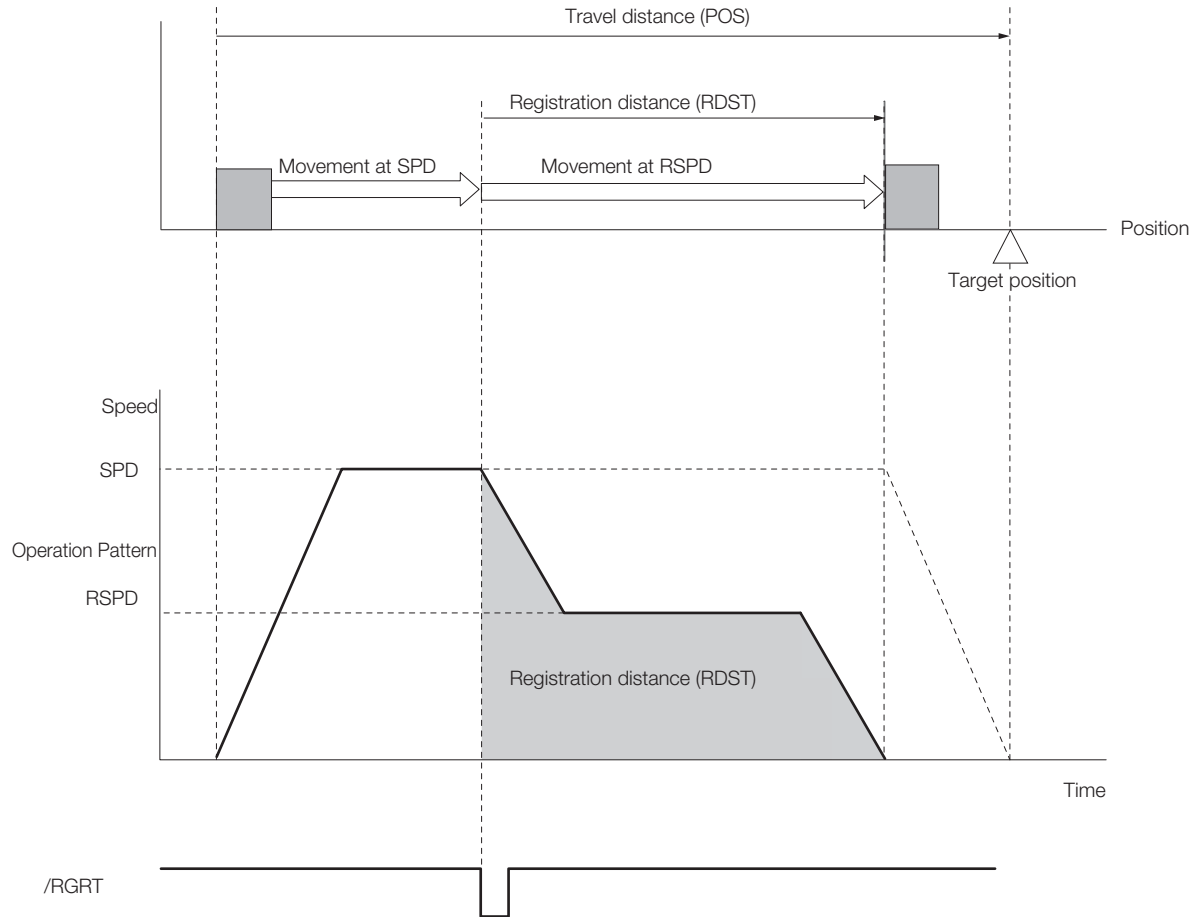

13.3.2 I/O Signals Related to Program Table Operation

The following I/O signals are related to program table operation.

Input Signals Related to Program Table Operation

Input Signal	Description	Reference
/MODE 0/1	ON: Mode 0 (program table operation) OFF: Mode 1 (jog speed table operation or homing)	page 6-4
/START-STOP	Turn ON this signal to start operation for the program step that is specified by the /SEL0 to /SEL4 (Program Step Selection Inputs) signals. Turn OFF this signal to stop program table operation and decelerate the motor to a stop.	page 6-4
/PGMRES	If this signal turns ON while a program table operation is stopped, the program table operation will be reset and canceled.*1	page 6-5
/SEL0 to /SEL7	These signals specify the program step number at which to start program table operation.*2	page 6-7
/RGRT	Registration operation starts on the rising edge of this signal.	page 6-4

*1. "Canceled" is the state in which the mode is mode 0, execution is not in a stopped state, and no program step has been executed.

*2. Use the eight selection signals (/SEL0 to /SEL7) to specify between 0 and 255 for PGMSTEP. A value of 1 means that the signal is ON (active), and a value of 0 means that the signal is OFF (inactive).

PGMSTEP	Selection Signals							
	/SEL7	/SEL6	/SEL5	/SEL4	/SEL3	/SEL2	/SEL1	/SEL0
0	0	0	0	0	0	0	0	0
1	0	0	0	0	0	0	0	1
2	0	0	0	0	0	0	1	0
3	0	0	0	0	0	0	1	1
4	0	0	0	0	0	1	0	0
5	0	0	0	0	0	1	0	1
6	0	0	0	0	0	1	1	0
7	0	0	0	0	0	1	1	1
8	0	0	0	0	1	0	0	0
254	1	1	1	1	1	1	1	0
255	1	1	1	1	1	1	1	1

Output Signals Related to Program Table Operation

Output Signal	Description
/COIN	This signal turns ON when the target position (final travel distance) is within the positioning completed width. It also turns ON when the Servomotor stops after positioning is canceled, even if the target position was not reached.
/POUT0 to /POUT7	You can set these signals as outputs. The output status is specified with POUT in the program steps.

13.3 Program Table Operation

13.3.3 Parameter Related to Program Table Operation

Information

The wiring for the signals, and the parameter settings, described in the table above are not necessary when program table operations are performed with serial commands. The following serial commands are used instead of the signals. Refer to the following section for details.

 *Chapter 14 Operation with Serial Command Communications*

Signal	Corresponding Serial Command
/MODE 0/1	None (Mode switching is not necessary.)
/START-STOP	Start: START SSS command (SSS = 000 to 255) Stop: STOP command
/SEL0 to /SEL7	Restart: START command
/PGMRES	PGMRES command

13.3.3 Parameter Related to Program Table Operation

Set the positioning completed width (INPOSITION width) and the near signal width (NEAR width) in the following parameters.

If you specify INPOSITION or NEAR as the end condition, the end condition is met when the difference between the target position specified for POS in the program table and the current position is less than or equal to the value set in one of the following parameters.

PnB2D	INPOSITION Width				
	Setting Range	Setting Unit	Default Setting	When Enabled	Classification
	0 to 9,9999	1 reference unit	1	Immediately	Setup
PnB2F	NEAR Width				
	Setting Range	Setting Unit	Default Setting	When Enabled	Classification
	0 to 9,9999	1 reference unit	1	Immediately	Setup

13.3.4 Program Table Configuration

The program table is a table that contains programming. You can enter up to 256 program steps.

The configuration of the program table is shown below. Each line in the table is called a program step. The steps are managed with program step numbers 0 to 255.

Refer to the following section for details on the items that are set.

 *13.3.5 Settings in the Program Table on page 13-13*

PGM-STEP	POS	SPD	RDST	RSPD	ACC	DEC	POUT	EVENT	LOOP	NEXT
0										
1										
2										
:	:	:	:	:	:	:	:	:	:	:
255										



Note

After you edit the program table, save it to flash memory. Refer to the following section for the operating procedure.

 *Saving the Program Table to Flash Memory in the SERVOPACK on page 13-24*

If you turn OFF the power supply before you save the program table in flash memory, the values that you set in the program table will be lost.

13.3.5 Settings in the Program Table

Item	Name	Meaning	Setting Procedure
PGM STEP	Program step	Numbers are used to identify the program steps in the program table.	The /SEL0 to /SEL7 signals are used to specify the program step.
POS	Target position	Specifies the target position.	Refer to the following section. POS on page 13-16
SPD	Positioning speed	Specifies the target speed for positioning.	Refer to the following section. SPD on page 13-17
RDST	Registration distance	Specifies the travel distance after the trigger signal (/RGRT) is input.	Refer to the following section. RDST on page 13-18
RSPD	Registration speed	Specifies the target speed for positioning after the trigger signal (/RGRT) is input.	Refer to the following section. RSPD on page 13-18
ACC	Acceleration rate	Specifies the acceleration rate to use to reach the positioning speed.	Refer to the following section.
DEC	Deceleration rate	Specifies the deceleration rate from the positioning speed.	ACC and DEC on page 13-19
POUT	Programmable output specification	<p>Specifies the output status of /POUT0 to /POUT7.</p> <p>n = N, A, Z, or: N: Not active (OFF) A: Active (ON) Z: ZONE signal</p> <p>A colon (:) indicates using the specification from the previous program step. Refer to the following section for information on the ZONE signals. 13.5 ZONE Outputs</p>	Refer to the following section. POUT (Output Signal) on page 13-20
EVENT	End condition	Specifies the condition to use to determine when the program step is completed. When the end condition is met and the number of executions specified for LOOP is completed, execution jumps to the program step specified by NEXT.	Refer to the following section. EVENT on page 13-21
LOOP	Number of loops	Specifies the number of times to execute the program step.	Refer to the following section. LOOP on page 13-21
NEXT	Next program step	Specify the program step to execute after completion of the current program step.	Refer to the following section. NEXT on page 13-22



Important

- If you specify new positioning during positioning, an E53E (Movement Reference Duplication) error will occur and program table operation will be stopped. To start operation again, turn the START-STOP signal OFF and then ON again. Execution will be restarted from the next step.
- If the target position (POS) is \pm INFINITE and the registration distance (RDST) is “-” (no registration), you can change the program step to change the speed. In this case, the Servomotor will simply change to the new speed. In all other cases, you cannot change the program step to change the speed. An E53E (Movement Reference Duplication) error will occur.
- You can change the settings in the program table only when program table operation is canceled. If program table operation is in progress or stopped, you cannot change the settings, even for program steps that are not currently being executed. An E5EE (Execution Not Possible during Program Table Operation) error will occur.

13.3.6 SigmaWin+ Procedures

You use the SigmaWin+ to edit, write, and save the program table.

A flowchart is provided below.

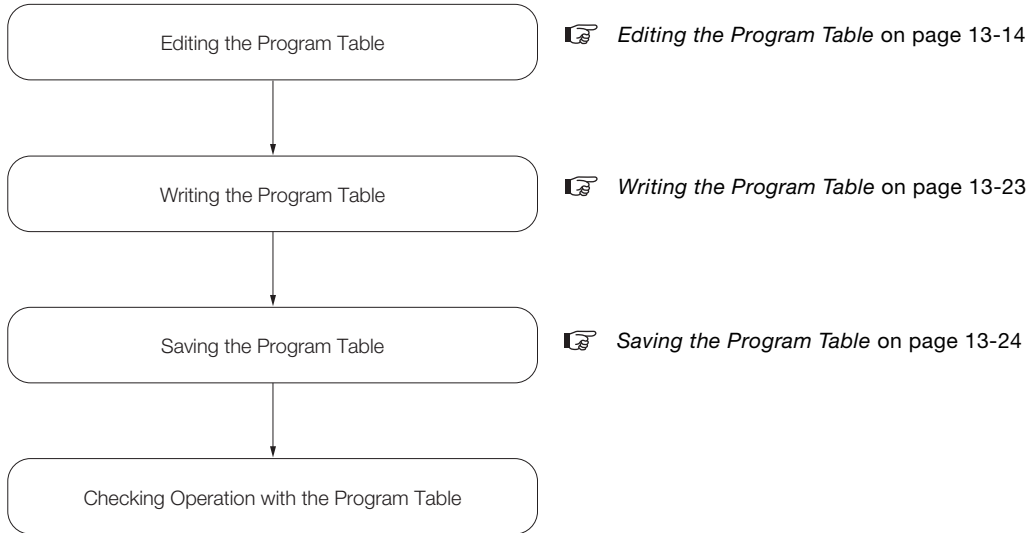



Editing the Program Table

◆ **Displaying the Program Table Editing Dialog Box.**

Select ***Edit Program Table*** in the Menu Dialog Box of the SigmaWin+.

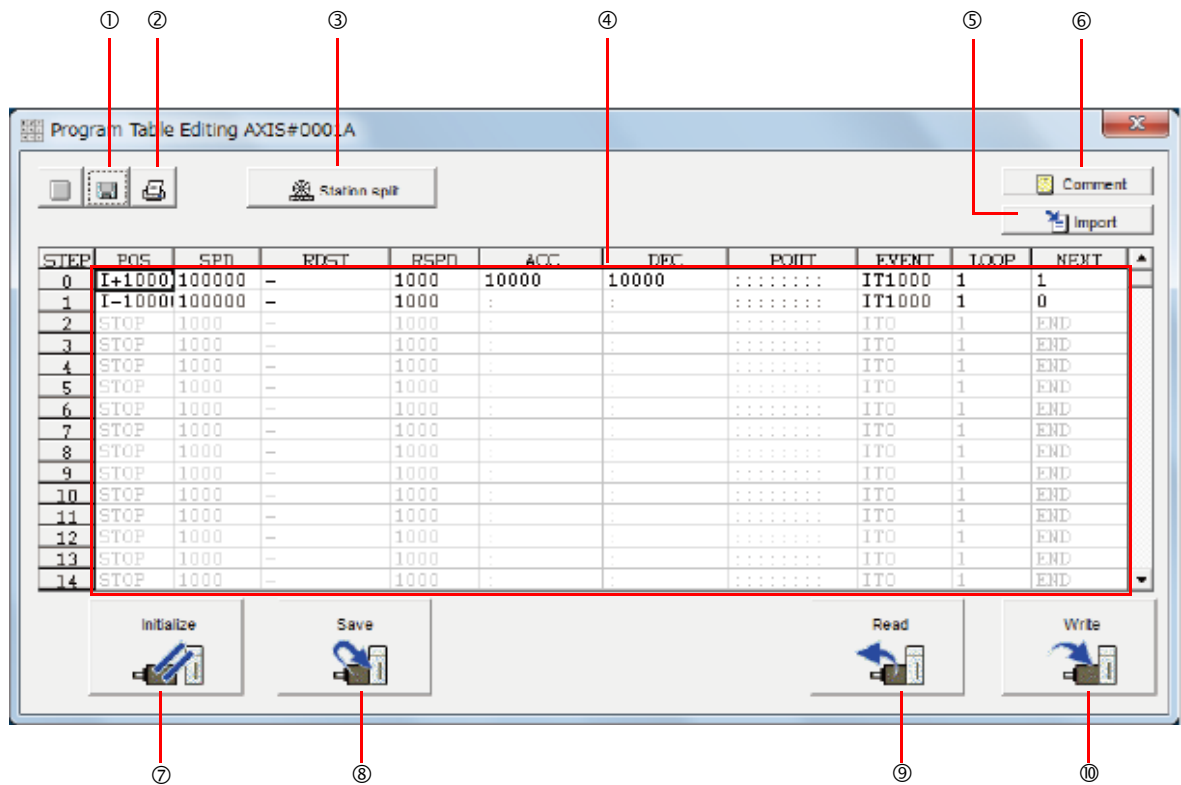
◆ Details on the Program Table Editing Dialog Box



No.	Item	Description
①	Save Button	Saves the program table currently displayed on the SigmaWin+ in a file on the computer.
②	Print Button	Used to print the program table.
③	Station split Button	Splits the valid coordinate range (i.e., the range defined by PnB21 to PnB23) into equal intervals and sets the resulting positions in the program table.
④	Program table editing cells	<p>You edit the program table here. The colors of the cells will change as follows:</p> <p>White: The values in SERVOPACK RAM is the same as the value in the SigmaWin+ table cells.</p> <p>Green: If any changes are made, the rows that include the changes change to green. When you write the changes, the cells change to white.</p> <p>Red: If there is a setting error, the row is displayed in red. The Write Button will be disabled.</p> <p>Refer to the following section for the table cell editing procedures.  ◆ <i>Editing Procedures</i> on page 13-16</p>
⑤	Import Button	Imports a file on the computer to a program table in SigmaWin+.
⑥	Comment Button	Lets you enter a comment for the program table. The comment is also saved when you click the Save Button.
⑦	Initialize Button	Initializes the flash memory for the program table in the SERVOPACK and restores the default settings.
⑧	Save Button	Saves the program table in RAM in the SERVOPACK to flash memory. If you save the program table to flash memory, it will not be lost even if you turn OFF the power supply. The next time you turn ON the power supply, the program table will be written to RAM.
⑨	Read Button	Reads the program table in RAM in the SERVOPACK to the SigmaWin+.
⑩	Write Button	Writes the program table currently displayed on the SigmaWin+ to the SERVOPACK. The program table is written only to RAM. Writing the program table enables program operation.

◆ Editing Procedures

The following two ways are used to edit the program table.

Note: The method that is used depends on the item.

- **Items That Are Entered Directly**

Click the cell to edit the item. Enter the setting directly.

STEP	POS	SPD
0	I+1000	1000000
1	I-1000	1000000
2	STOP	1000

- **Items with Dialog Boxes**

Double-click the cell to display the dialog box for editing. Make the settings in the dialog box.

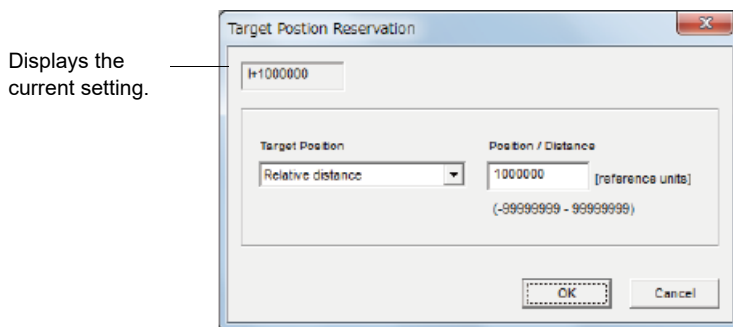

Setting procedures are provided below for each item.

■ POS

Set the target positions.

1. **Double-click the cell to edit.**

The Target Position Reservation Dialog Box will be displayed.

2. **Set the target position and the position/distance.**

Information The **Position/Distance** setting is enabled when you set the target position to an absolute position or relative distance.

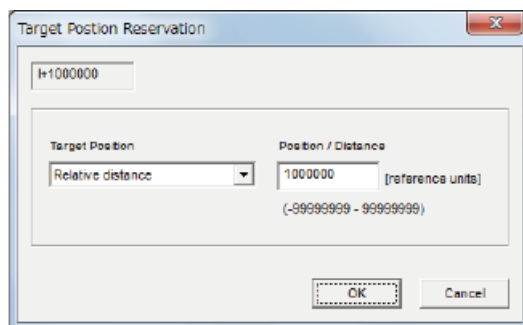

- Target position

Selected Item	Description	Display in Program Table
Absolute position	Use this setting to specify the target position directly.	A ± Position
Relative distance	Use this setting to specify the relative position (travel distance) from the previous step.	I ± Distance
Infinity (Positive direction)* ¹	Constant-speed operation is performed in the forward direction.	+INFINITE
Infinity (Negative direction)* ¹	Constant-speed operation is performed in the reverse direction.	-INFINITE
Stop [default setting]	The axis is not moved. Use this setting to stop constant-speed operation when the target position is set to infinite.	STOP
Consecutive stop* ²	Specify the absolute target position within the rotational coordinates to perform positioning after constant-speed operation.	S + Position
Without reference	The axis is not moved. This setting can be used only when POUT is specified.	–

*1. You can use the INFINITE settings for the target positions only for rotational coordinates (PnB20 = 1, 2, or 3) or when the software limits are not used (PnB21 and PnB23 = 0). An error will occur if you use an INFINITE setting for linear coordinates or when the software limits are enabled.

*2. You can use consecutive stop settings for the target positions for rotational coordinates (PnB20 = 1, 2, or 3) or when the target position in the previous step is set to INFINITE. A consecutive stop setting will result in an error if linear coordinates are being used or if the target position for the previous step is not INFINITE. Also, you cannot use the consecutive stop setting in combination with a speed change for an infinite target position setting.

- Position/Distance

Unit	Setting Range	Default Setting
1 reference unit	<ul style="list-style-type: none"> • PnB54 = 0 (Disable Expansion Mode): -99,999,999 to +99,999,999 • PnB54 = 1 (Enable Expansion Mode): -1,073,741,823 to +1,073,741,823 	STOP

3. Click the OK Button.

This concludes the setting procedure.

■ SPD

Specify the target speeds for positioning.

Select the cells to edit and enter the values directly.

Unit	Setting Range	Default Setting
1,000 reference units/min	<ul style="list-style-type: none"> • PnB54 = 0 (Disable Expansion Mode): 1 to 99,999,999 • PnB54 = 1 (Enable Expansion Mode): 1 to 199,999,999 	1,000

■ RDST

Set the registration absolute distance.

- Note: 1. You cannot use registration in combination with a speed change with an infinite target position setting.
 2. You cannot use registration in combination with consecutive stopping.

1. Double-click the cell to edit.

The Registration Relative Position Dialog Box will be displayed.

Using Registration

2. Clear the selection of the No registration Check Box and enter the registration absolute distance.

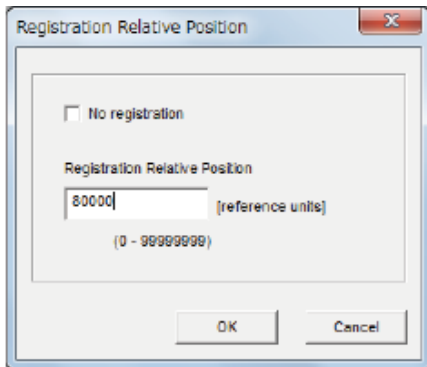

Unit	Setting Range	Default Setting
1,000 reference units/min	<ul style="list-style-type: none"> • PnB54 = 0 (Disable Expansion Mode): 1 to 99,999,999 • PnB54 = 1 (Enable Expansion Mode): 1 to 199,999,999 	1,000

Not Using Registration

2. Select the No registration Check Box.

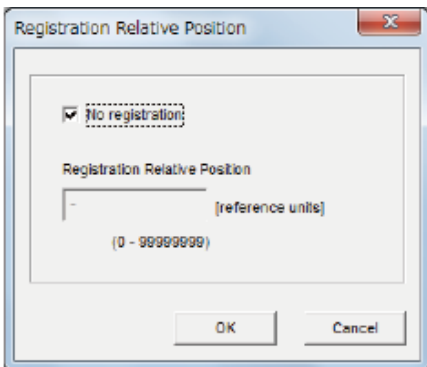

3. Click the OK Button.

This concludes the setting procedure.

■ RSPD

Set the registration speed.

Select the cell to edit and set the value directly.

Unit	Setting Range	Default Setting
1,000 reference units/min	<ul style="list-style-type: none"> • PnB54 = 0 (Disable Expansion Mode): 1 to 99,999,999 • PnB54 = 1 (Enable Expansion Mode): 1 to 199,999,999 	1,000

■ ACC and DEC

Set the acceleration rate (ACC) and deceleration rate (DEC) for movement.

1. Double-click a cell under ACC or DEC.

The Acceleration/Deceleration Dialog Box will be displayed.

2. Set the acceleration and deceleration rates.

The **Same as previous step** Check Boxes are selected by default.

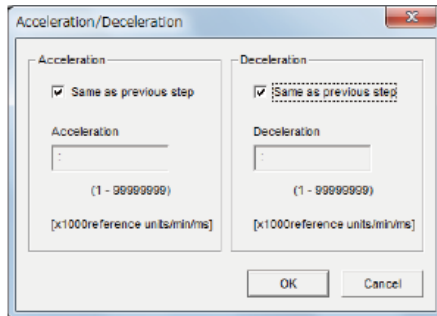

To use different values from the previous step, clear the selections of the **Same as previous step** Check Boxes and enter the values directly.

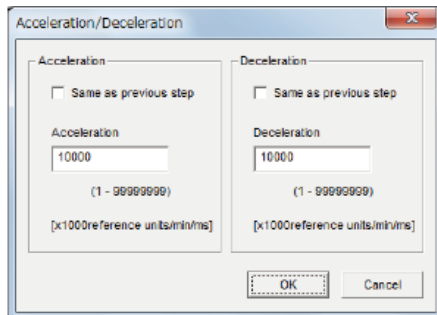

Unit	Setting Range	Default Setting
1,000 (reference units/min)/ms	<ul style="list-style-type: none"> PnB54 = 0 (Disable Expansion Mode): 1 to 99,999,999 PnB54 = 1 (Enable Expansion Mode): 1 to 199,999,999 	:

3. Click the OK Button.

This concludes the setting procedure.



Note

If you select the **Same as Previous Step** Check Box in the first program step, the acceleration rate that was valid before program table operation was started (PnB29 (Acceleration Rate), set with the ACC serial command) and the deceleration rate that was valid before program table operation was started (PnB2B (Deceleration Rate), set with the DEC serial command) will be used.

■ **POUT (Output Signal)**

Specify the signals to output immediately after program step execution is started.

- Note: 1. If you want to output the signal at the end of the step, specify POUT as POS = "-" in the next step.
 2. It is possible to set a ZONE signal for /POUT5 to /POUT7, but the output is always OFF.

1. Double-click the cell to edit.

The Output Signal Dialog Box will be displayed.

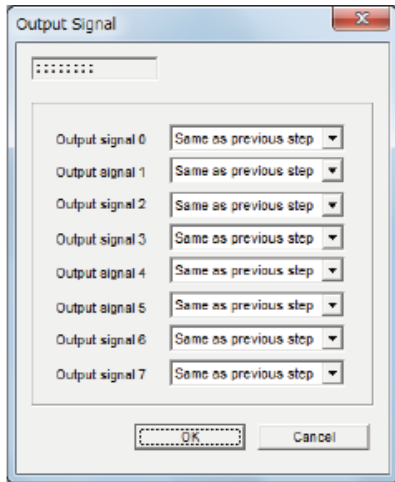

2. Select the settings for output signals 0 to 7 in the boxes.

The corresponding terminals are given below.

- Output signal 0: /POUT0 terminal
- Output signal 1: /POUT1 terminal
- Output signal 2: /POUT2 terminal
- Output signal 3: /POUT3 terminal
- Output signal 4: /POUT4 terminal
- Output signal 5: /POUT5 terminal
- Output signal 6: /POUT6 terminal
- Output signal 7: /POUT7 terminal

Selection Items	Description	Program Table Notation
Active	Always ON	A
Not Active	Always OFF	N
Same as previous step	Continues previous state.	:
ZONE	Sets the ZONE signal (/Z0 to /Z4) that corresponds to that digit.	Z

3. Click the OK Button.

This concludes the setting procedure.

■ EVENT

Specify the conditions to complete execution of the program steps.

When the end condition is met and the number of executions specified for LOOP is completed, execution jumps to the program step specified by NEXT. If the number of executions specified for LOOP has not been completed, the step will be executed again.

1. Double-click the cell to edit.

The Event Dialog Box will be displayed.

2. Set the condition and the wait time.

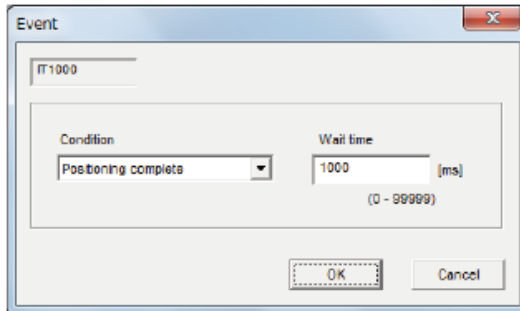

• Condition

Selected Item	Description	Display in Program Table
Positioning complete [default setting]	The step ends when the /INPOSITION (Positioning Completed Output) signal turns ON (closes).*	I
NEAR	The step ends when the /NEAR signal width is entered.*	N
Command Issuance Completion	The step ends when position reference distribution is completed (DEN).*	D
SEL0, SEL1, ...	The step ends when the /SELx input signal turns ON (closes).* x = 0 to 7	SELx
Wait time	Execution waits for n milliseconds after the /INPOSITION (Positioning Completion Output) signal turns ON (closes).	ITn
	Execution waits for n milliseconds after the /NEAR (Near Output) signal turns ON (closes).	NTn
	Execution waits for n milliseconds after position reference distribution is completed (DEN).	DTn
	Execution waits for n milliseconds after the SELx input signal turns ON (closes).	SELxTn
Same as previous step	The condition from the previous program step is used.	:

* The edge is not detected, the level is.

• Wait Time

Unit for "n"	Setting Range of "n"	Default Setting
ms	0 to 99,999	IT0

3. Click the OK Button.

This concludes the setting procedure.

■ LOOP

Specify the number of times to execute the step.

Note: NEXT is accessed after the number of executions specified with LOOP has been completed. You cannot specify LOOP across more than one program step.

Select the cell to edit and set the value directly.

Unit	Setting Range	Default Setting
Times	1 to 99,999	1

■ **NEXT**

Specify the operation to perform after execution of the current program step is completed.

1. Double-click the cell to edit.

The Next Step Dialog Box will be displayed.

Executing a Next Step

2. Clear the selection of the END Check Box and set a value between 0 and 255 for the next step number.

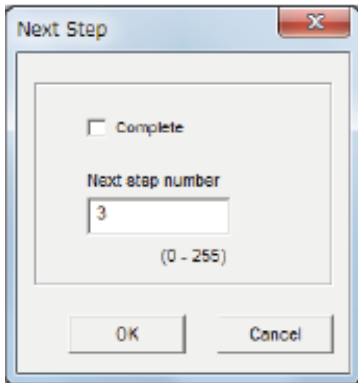

Unit	Setting Range	Default Setting
-	0 to 255	END*

* Program table operation is ended and canceled.

Ending Program Execution at the Current Step

2. Select the Complete Check Box.

When execution of the current program step is completed, program execution will be canceled.

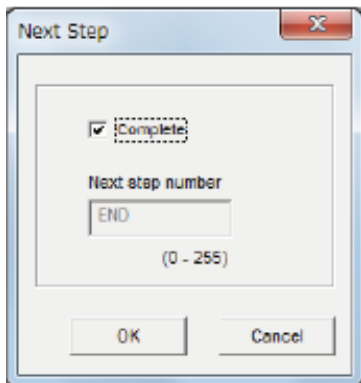

3. Click the OK Button.

This concludes the setting procedure.

Writing the Program Table

You can write the edited program table to SERVOPACK RAM to operate the SERVOPACK according to the program table.



Note

1. Make sure that the system is in SERVO OFF state when you write the program table.
2. The program table that is written will be deleted when the power supply to the SERVOPACK is turned OFF. Before you turn OFF the power supply to the SERVOPACK, save the program table from RAM to flash memory. Refer to the following section for the procedure.
Saving the Program Table on page 13-24

1. Click the Write Button in the Program Table Editing Dialog Box.

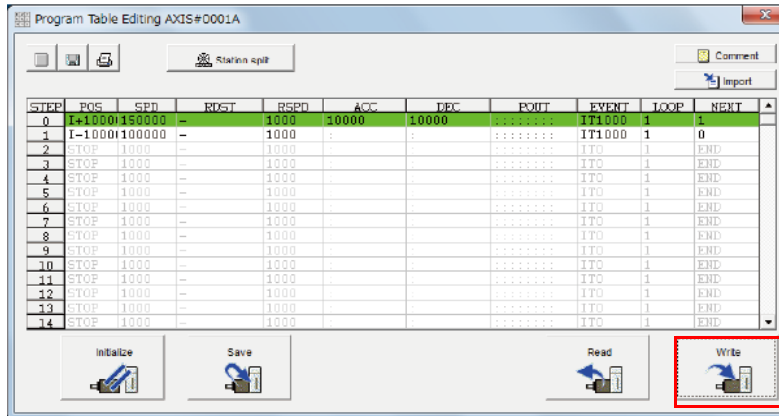

The Write Dialog Box will be displayed.

2. Click the OK Button.

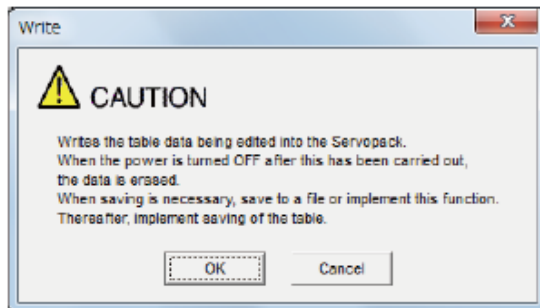

The program table edited on the SigmaWin+ will be written to the SERVOPACK and all edited cells will change to white.

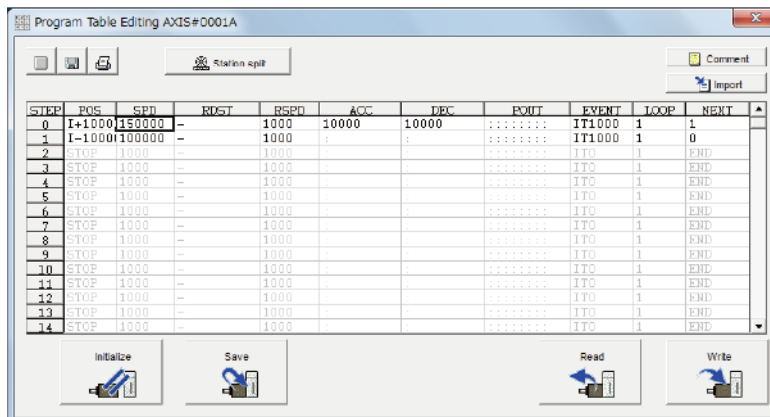

This concludes the writing procedure.

Saving the Program Table

◆ Saving the Program Table to Flash Memory in the SERVOPACK

To prevent the program table from being deleted when the power supply to the SERVOPACK is turned OFF, you must save it to flash memory in the SERVOPACK. The program table that is saved in the flash memory is automatically loaded each time the power supply is turned ON. We recommend that you save the program table that is normally used for operation in this flash memory.

There are the following three ways to save the program table to flash memory in the SERVOPACK.

- Save it from the Edit Program Dialog Box.
- Save it with the PGMSTORE serial command.
- Save it with FnB03 (Edit/Save Program Table) on a Digital Operator.

Use the following procedure to save the program table from the Edit Program Dialog Box.

1. Click the **Save Button** in the Program Table Editing Dialog Box.

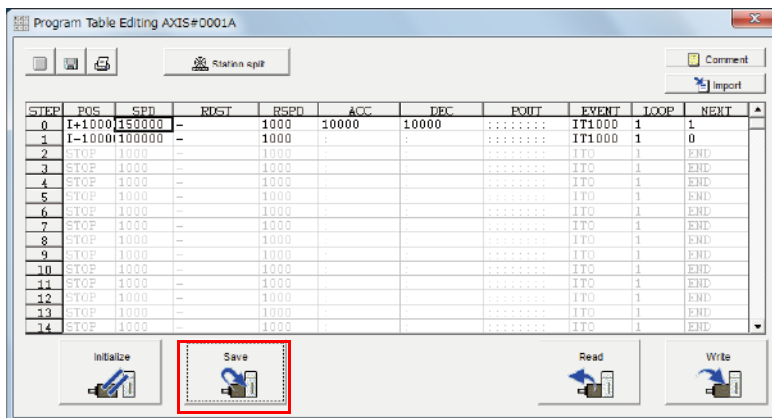

The Save Table Dialog Box will be displayed.

2. Click the **OK Button**.

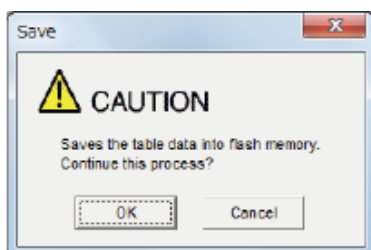

This concludes the saving procedure.

◆ Saving the Program Table to a Computer File

You can save the program table to a file on the computer. Use computer files to back up program tables.

1. Click the Save Button.

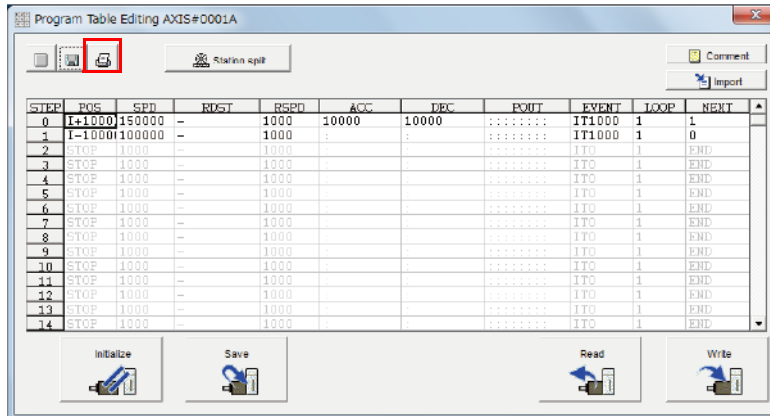

The Open Dialog Box will be displayed.

2. Specify the save location and file name.

You can set any file name. However, you cannot change the file name extension.

Information You can also set a comment.

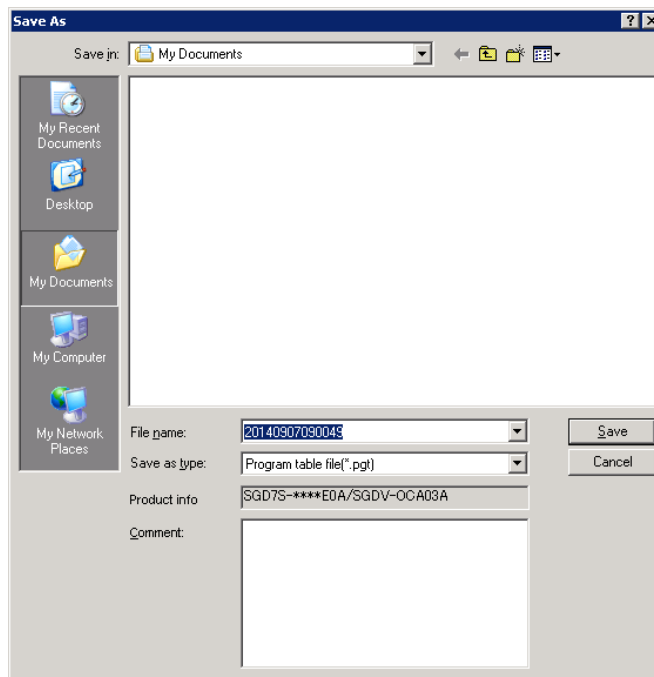

Information You can use the **Import** Button to load the program table saved in a file to the SERVO-PACK.

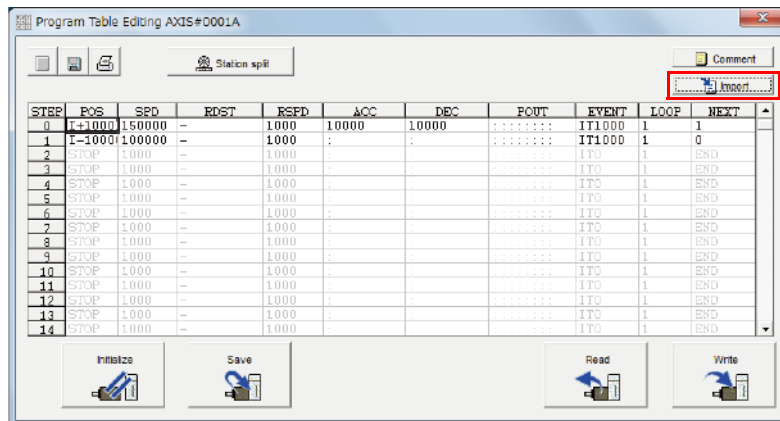

This concludes the saving procedure.

13.3.7 State Transitions

Program table operation can be in any of three states: Canceled, operating, or stopped.

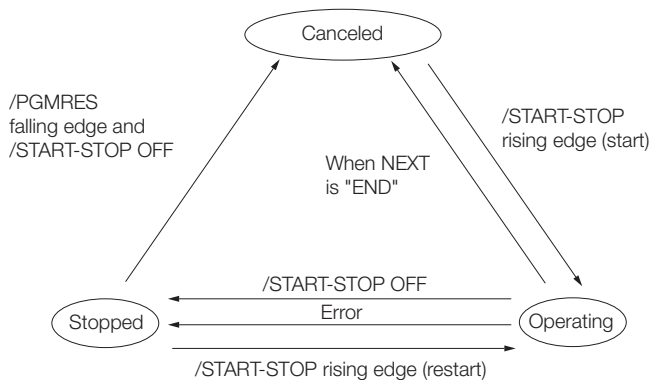

	Transition Condition		State Transition		
	/START-STOP	/PRGRES	Canceled	Operating	Stopped
Transition			● →		
				● →	
			←		●
				←	●

- Note: 1. "Canceled state" means that the mode is mode 0, execution is not in a stopped state, and no program step is being executed.
 2. The status will also change from operating to canceled in the following case: The next step is set to END in the program table.
 The status will also change from operating to stopped in the following case: An error occurs during operation.

Note If the program table operation is restarted after it is stopped because of an error, the PGMSTEP in which the error occurred will be skipped and execution will be restarted from the PGMSTEP specified by NEXT. (If the operation has not been executed for the number of times specified in the LOOP, the next LOOP will be executed.)

13.3.8 Program Table Operation Examples

This section provides the following 12 examples to show the timing of the I/O signals related to program table operation.

In the following examples, it is assumed that an homing has been completed to define the origin.

Refer to the following section for a timing chart from when the power supply to the equipment is turned ON until homing is completed when an incremental encoder is used.

 13.2 Homing on page 13-4

No.	Item	Reference
1	Specifying the Program Steps to Execute One at a Time	page 13-27
2	Specifying the Next Step to Execute in the NEXT Setting	page 13-29
3	Specifying the Number of Times to Execute a Program Step	page 13-30
4	Pausing Program Table Operation	page 13-31
5	Outputting POUT Signals for the Specified Time	page 13-33
6	Specifying SEL Signals as Events	page 13-34
7	Combining Positioning with Constant-Speed Operation	page 13-35
8	Performing Registration	page 13-36
9	Pausing Registration	page 13-37
10	Turning ON the /RGRT Signal While Program Table Operation Is Stopped	page 13-38
11	Using Consecutive Stops	page 13-39
12	Resetting Program Table Operation	page 13-41

Specifying the Program Steps to Execute One at a Time

In this example, the program table contains steps 0 to 5, but only program steps 3 and 5 are executed.

Step 3 performs relative positioning for 100,000 reference units at a speed of 15,000,000 references units/min. The acceleration/deceleration rates that are set in PnB29 and PnB2B are used.

Step 5 performs relative positioning for 300,000 reference units at a speed of 30,000,000 references units/min with the same acceleration/deceleration rates as step 3.

The program table for this positioning is shown below.

PGMSTEP	POS	SPD	RDST	RSPD	ACC	DEC	POUT	EVENT	LOOP	NEXT
0	I+100000	15000	-	1000	:	:	NNNNNNNA	IT2000	1	END
1	A+100000	15000	-	1000	:	:	NNNNNNAN	IT2000	1	END
2	I+300000	15000	-	1000	:	:	NNNNNANN	IT2000	1	END
3	I+100000	15000	-	1000	:	:	NNNNANNN	IT2000	1	END
4	I+200000	30000	-	1000	:	:	NNNANNNN	IT2000	1	END
5	I+300000	30000	-	1000	:	:	NNANNNNN	IT2000	1	END

13.3 Program Table Operation

13.3.8 Program Table Operation Examples

- Operating Procedure
 - ① Turn ON the /MODE 0/1 signal to change to mode 0.
 - ② Set the /SEL0 to /SEL7 signals to 3 (i.e., turn ON /SEL0 and /SEL1) to specify program step 3.
 - ③ Turn ON the /START-STOP signal to start program table operation.
The /INPOSITION signal turns OFF and the /POUT3 signal turns ON.
 - ④ When positioning is completed to the target position, the /INPOSITION signal turns ON.
 - ⑤ Turn OFF the /START-STOP signal.
 - ⑥ Set the /SEL0 to /SEL7 signals to 5 (i.e., turn ON /SEL0 and /SEL2) to specify program step 5.
 - ⑦ Turn ON the /START-STOP signal to start program table operation.
The /POUT5 signal turns ON.
 - ⑧ When positioning is completed to the target position, the /INPOSITION signal turns ON.

- Operation Pattern and Related Signal Timing

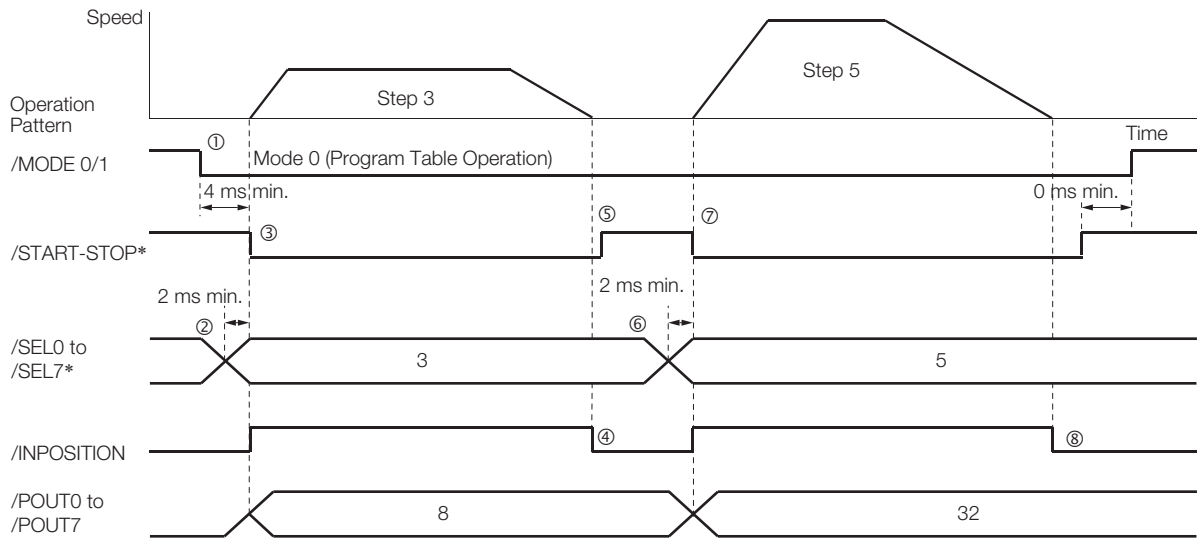

* Do not change /SEL0 to /SEL7 for 4 ms after turning ON the /START-STOP signal.

Specifying the Next Step to Execute in the NEXT Setting

In this example, repeated positioning is performed using program steps 0 and 1.

Step 0 performs relative positioning for 300,000 reference units at a speed of 15,000,000 reference units/min. The acceleration rate is 400,000,000 reference units/min/ms and the deceleration rate is 200,000,000 reference units/min/ms.

Step 1 performs relative positioning for -400,000 reference units at a speed of 20,000,000 reference units/min. The acceleration rate is 500,000,000 reference units/min/ms and the deceleration rate is 250,000,000 reference units/min/ms.

The program table for this positioning is shown below.

PGM-STEP	POS	SPD	RDST	RSPD	ACC	DEC	POUT	EVENT	LOOP	NEXT
0	I+300000	15000	-	1000	400000	200000	NNNNNNNA	IT1000	1	1
1	I-400000	20000	-	1000	500000	250000	NNNNNNAN	IT2000	1	0

• Operating Procedure

- ① Turn ON the /MODE 0/1 signal to change to mode 0.
- ② Set the /SEL0 to /SEL7 signals to 0 to specify program step 0.
- ③ Turn ON the /START-STOP signal to start program table operation.
The /INPOSITION signal turns OFF and the /POUT0 signal turns ON.
- ④ When positioning is completed to the target position, the /INPOSITION signal turns ON.
- ⑤ After a wait time of 1 second, execution of the program step specified with the NEXT setting (program step 1) is executed.
The /INPOSITION and POUT0 signals turn OFF and the /POUT1 signal turns ON.
- ⑥ When positioning is completed to the target position, the /INPOSITION signal turns ON.
- ⑦ After a wait time of 2 seconds, execution of the program step specified with the NEXT setting (program step 0) is executed.
- ⑧ Steps 4 to 7 are repeated.

• Operation Pattern and Related Signal Timing

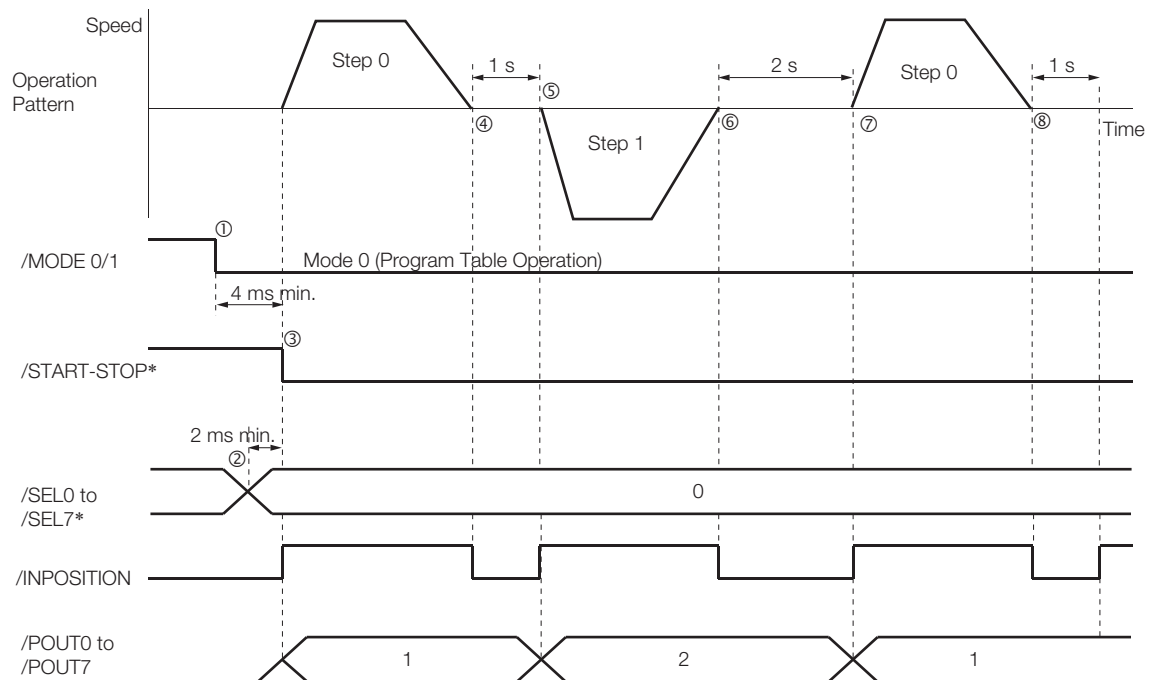

* Do not change /SEL0 to /SEL7 for 4 ms after turning ON the /START-STOP signal.

Specifying the Number of Times to Execute a Program Step

In this example, program step 0 is executed and then step 1 is executed three times.

Step 0 performs relative positioning for 300,000 reference units at a speed of 15,000,000 reference units/min. The acceleration rate is 400,000,000 reference units/min/ms and the deceleration rate is 200,000,000 reference units/min/ms.

Step 1 performs relative positioning for -400,000 reference units at a speed of 20,000,000 reference units/min. The acceleration rate is 500,000,000 reference units/min/ms and the deceleration rate is 250,000,000 reference units/min/ms. The number of loops for step 1 is set to 2.

The program table for this positioning is shown below.

PGM-STEP	POS	SPD	RDST	RSPD	ACC	DEC	POUT	EVENT	LOOP	NEXT
0	I+300000	15000	-	1000	400000	200000	NNNNNNNA	IT1000	1	1
1	I-400000	20000	-	1000	500000	250000	NNNNNNAN	IT2000	3	END

Operating Procedure

- ① Turn ON the /MODE 0/1 signal to change to mode 0.
- ② Set the /SEL0 to /SEL7 signals to 0 to specify program step 0.
- ③ Turn ON the /START-STOP signal to start program table operation.
The /INPOSITION signal turns OFF and the /POUT0 signal turns ON.
- ④ When positioning is completed to the target position, the /INPOSITION signal turns ON.
- ⑤ After a wait time of 1 second, execution of the program step specified with the NEXT setting (program step 1) is executed.
The /INPOSITION and /POUT0 signals turn OFF and the /POUT1 signal turns ON.
- ⑥ When positioning is completed to the target position, the /INPOSITION signal turns ON.
- ⑦ After a wait time of 2 seconds, execution of program step 1 is started twice.
The /INPOSITION signal turns OFF.
- ⑧ When positioning is completed to the target position, the /INPOSITION signal turns ON.
- ⑨ After a wait time of 2 seconds, execution of program step 1 is started a third time.
The /INPOSITION signal turns OFF.
- ⑩ When positioning is completed to the target position, the /INPOSITION signal turns ON.
- ⑪ After a wait time of 2 seconds, program table operation is ended and the /POUT1 signal turns OFF.

Operation Pattern and Related Signal Timing

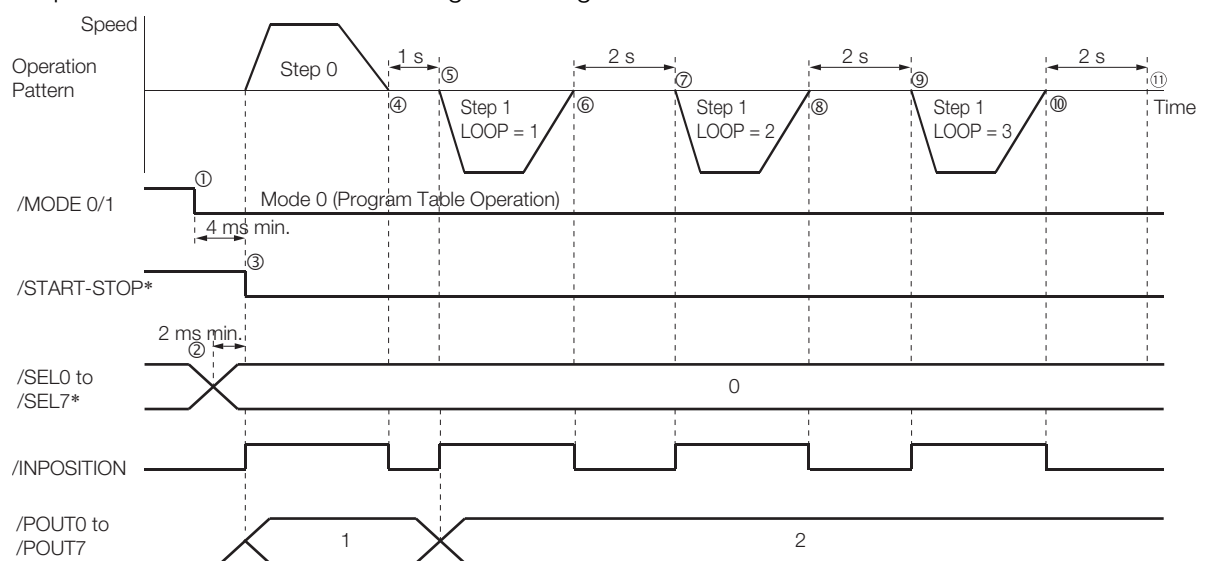

* Do not change /SEL0 to /SEL7 for 4 ms after turning ON the /START-STOP signal.

Pausing Program Table Operation

This example shows how to turn OFF the /START-STOP signal to temporarily stop program table operation and then turn ON the /START-STOP signal to execute the remainder of the step.

Execution is temporarily stopped and then restarted during execution of program step 4.

The program table for this positioning is shown below.

PGM-STEP	POS	SPD	RDST	RSPD	ACC	DEC	POUT	EVENT	LOOP	NEXT
0	I+100000	15000	-	1000	400000	200000	NNNNNNNA	IT1000	1	END
1	A+100000	15000	-	1000	:	:	NNNNNNAN	IT2000	1	END
2	I+300000	15000	-	1000	:	:	NNNNNANN	IT3000	1	END
3	I+100000	15000	-	1000	:	:	NNNNANNN	IT2000	1	END
4	I+200000	30000	-	1000	200000	200000	NNNANNNN	IT2000	1	END

• Operating Procedure

- ① Turn ON the /MODE 0/1 signal to change to mode 0.
- ② Set the /SEL0 to /SEL7 signals to 4 (i.e., turn ON /SEL2) to specify program step 4.
- ③ Turn ON the /START-STOP signal to start program table operation.
The /INPOSITION signal turns OFF and the /POUT4 signal turns ON.
- ④ Turn OFF the /START-STOP signal to stop program table operation.
The Servomotor will decelerate to a stop.
- ⑤ The Servomotor will decelerate to a stop.
- ⑥ Turn ON the /START-STOP signal to restart program table operation.
The /SEL0 to /SEL7 signals are not latched at this time.
- ⑦ When positioning is completed to the target position, the /INPOSITION signal turns ON.

• Operation Pattern and Related Signal Timing

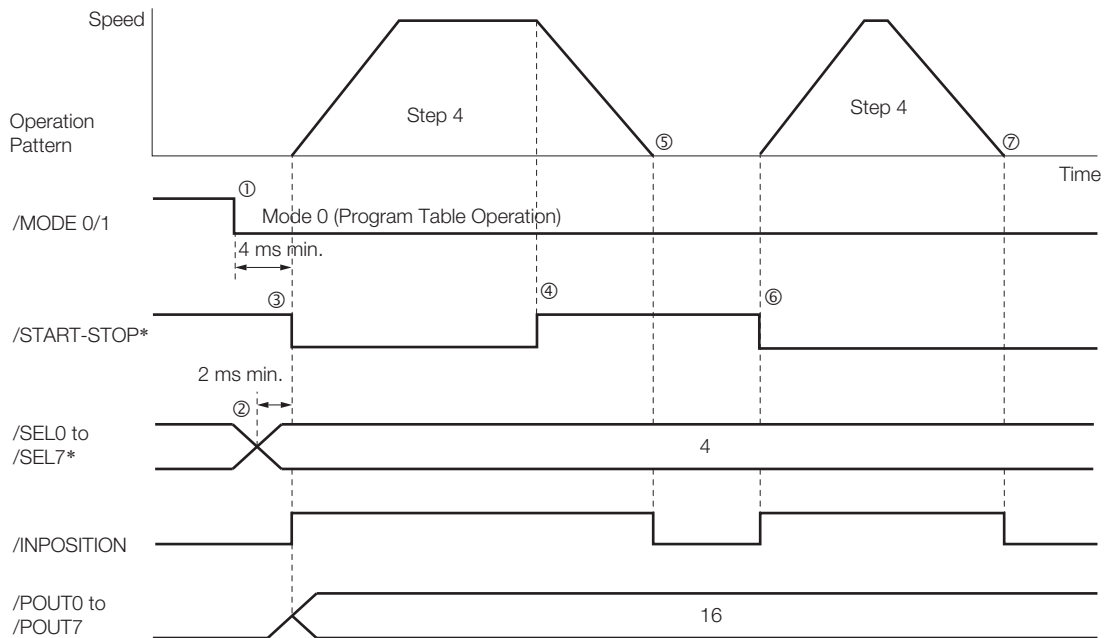

* Do not change /SEL0 to /SEL7 for 4 ms after turning ON the /START-STOP signal.

As described below, operation is restarted even when the /START-STOP signal is turned ON even during deceleration after the /START-STOP signal is turned OFF.

- Operating Procedure
 - ① Turn ON the /MODE 0/1 signal to change to mode 0.
 - ② Set the /SEL0 to /SEL7 signals to 4 (i.e., turn ON /SEL2) to specify program step 4.
 - ③ Turn ON the /START-STOP signal to start program table operation. The /INPOSITION signal turns OFF and the /POUT4 signal turns ON.
 - ④ Turn OFF the /START-STOP signal to stop program table operation.
 - ⑤ Turn ON the /START-STOP signal while the Servomotor is decelerating. Program table operation is restarted. The remaining travel distance will be executed.
 - ⑥ When positioning is completed to the target position, the /INPOSITION signal turns ON.

• Operation Pattern and Related Signal Timing

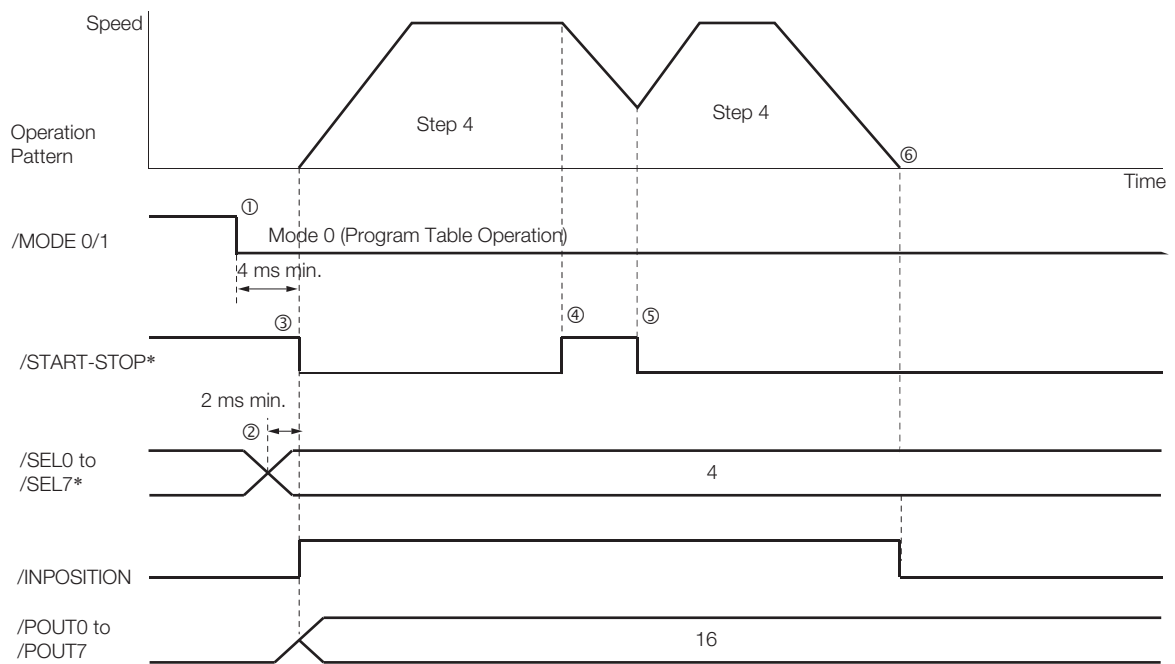

* Do not change /SEL0 to /SEL7 for 4 ms after turning ON the /START-STOP signal.

Outputting POUT Signals for the Specified Time

This example shows how to output the POUT signals in the next step for the specified length of time after completing positioning for a program step.

Positioning is registered for steps 0, 2, and 4. POUT signal outputs are specified for steps 1, 3, and 5.

The program table for this positioning is shown below.

PGM-STEP	POS	SPD	RDST	RSPD	ACC	DEC	POUT	EVENT	LOOP	NEXT
0	I+200000	15000	-	1000	400000	200000	NNNNNNNN	IT0	1	1
1	-	15000	-	1000	:	:	:::::::A	T2000	1	2
2	I-200000	30000	-	1000	:	:	NNNNNNNN	IT0	1	3
3	-	30000	-	1000	:	:	:::::::A	T2000	1	4
4	I-200000	30000	-	1000	:	:	NNNNNNNN	IT0	1	5
5	-	30000	-	1000	:	:	:::::::A	T2000	1	0

Operating Procedure

- ① Turn ON the /MODE 0/1 signal to change to mode 0.
- ② Set the /SEL0 to /SEL7 signals to 0 to specify program step 0.
- ③ Turn ON the /START-STOP signal to start program table operation.
The /INPOSITION signal turns OFF.
- ④ When positioning is completed to the target position, the /INPOSITION signal turns ON.
Execution moves to program step 1 and the /POUT0 signal turns ON.
- ⑤ After a wait time of 2 seconds, execution of the program step specified with the NEXT setting (program step 2) is executed.
The /INPOSITION signal turns OFF.
- ⑥ When positioning is completed to the target position, the /INPOSITION signal turns ON.
Execution moves to program step 3 and the /POUT1 signal turns ON.
- ⑦ After a wait time of 2 seconds, execution of the program step specified with the NEXT setting (program step 4) is executed.
The /INPOSITION signal turns OFF.
- ⑧ When positioning is completed to the target position, the /INPOSITION signal turns ON.
Execution moves to program step 5 and the /POUT2 signal turns ON.
- ⑨ After a wait time of 2 seconds, execution of the program step specified with the NEXT setting (program step 0) is executed.
The /INPOSITION signal turns OFF.
- ⑩ Steps 4 to 9 are repeated.

Operation Pattern and Related Signal Timing

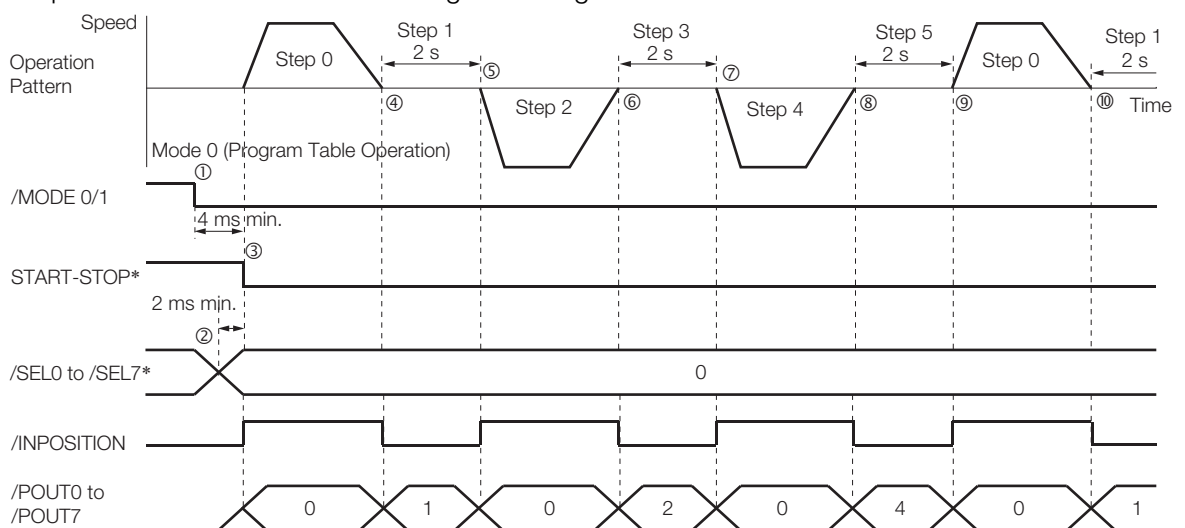

* Do not change /SEL0 to /SEL7 for 4 ms after turning ON the /START-STOP signal.

Specifying SEL Signals as Events

In this example, SEL signals are specified as the end conditions for the program steps. Step 0 ends 2 seconds after the /SEL0 signal turns ON after positioning is completed. Step 1 ends 2 seconds after the /SEL1 signal turns ON after positioning is completed. The program table for this positioning is shown below.

PGM-STEP	POS	SPD	RDST	RSPD	ACC	DEC	POUT	EVENT	LOOP	NEXT
0	I+200000	15000	-	1000	400000	200000	NNNNNNNA	SEL0T2000	1	1
1	I-200000	30000	-	1000	400000	200000	NNNNNNAN	SEL1T2000	2	0

• Operating Procedure

- ① Turn ON the /MODE 0/1 signal to change to mode 0.
- ② Set the /SEL0 to /SEL7 signals to 0 to specify program step 0.
- ③ Turn ON the /START-STOP signal to start program table operation.
The /INPOSITION signal turns OFF and the /POUT0 signal turns ON.
- ④ When positioning is completed to the target position, the /INPOSITION signal turns ON.
- ⑤ The /SEL0 signal turns ON.
- ⑥ After a wait time of 2 seconds, execution of the program step specified with the NEXT setting (program step 1) is executed.
The /INPOSITION signal turns OFF and the /POUT1 signal turns ON.
- ⑦ When positioning is completed to the target position, the /INPOSITION signal turns ON.
- ⑧ The /SEL1 signal turns ON.
- ⑨ After a wait time of 2 seconds, program step 1 is executed again.
The /INPOSITION signal turns OFF.
- ⑩ When positioning is completed to the target position, the /INPOSITION signal turns ON.
- ⑪ The /SEL1 signal turns ON.
- ⑫ After a wait time of 2 seconds, execution of the program step specified with the NEXT setting (program step 0) is executed.
The /INPOSITION and /POUT1 signals turn OFF and the /POUT0 signal turns ON.
- ⑬ Steps 4 to 12 are repeated.

• Operation Pattern and Related Signal Timing

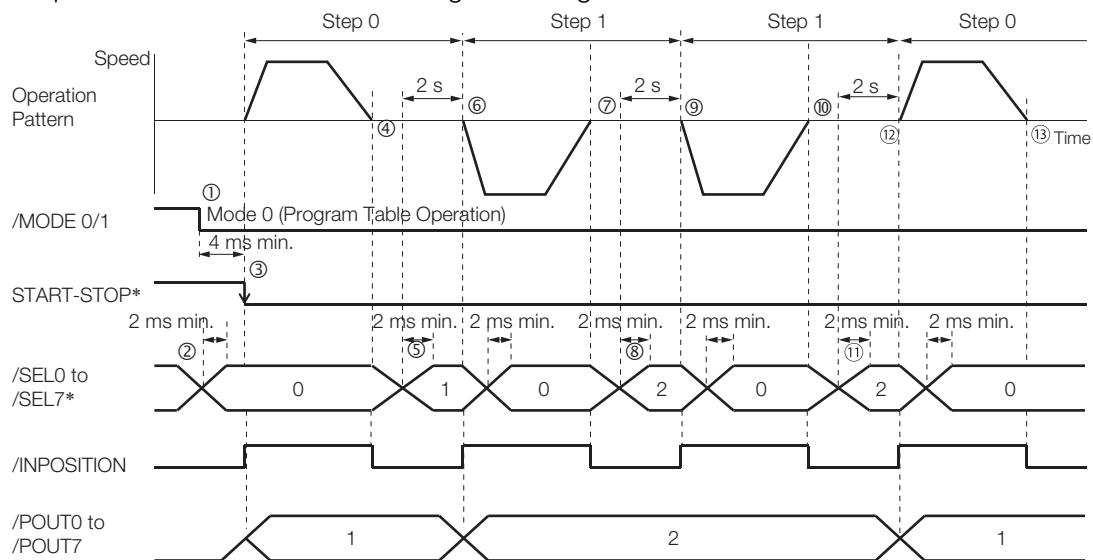

* Do not change /SEL0 to /SEL7 for 4 ms after turning ON the /START-STOP signal.

Combining Positioning with Constant-Speed Operation

This example shows how to perform operation that combines constant-speed operation and positioning when the target position (POS) is set to INFINITE.

Step 0 performs operation for 2 seconds with no target position (infinite length = INFINITE) at a speed of 15,000,000 reference units/min.

Step 1 performs operation with no target position (infinite length = INFINITE) and changes the speed from 15,000,000 reference units/min to 30,000,000 reference units/min. Operation continues until the /SEL0 signal turns ON.

Step 2 decelerates the motor to a stop and step 3 performs relative positioning from the stop position to a target position of 200,000 reference units.

PGM-STEP	POS	SPD	RDST	RSPD	ACC	DEC	POUT	EVENT	LOOP	NEXT
0	+INFINITE	15000	-	1000	400000	200000	NNNNNNNN	T2000	1	1
1	+INFINITE	30000	-	1000	:	:	:	SELOTO	1	2
2	STOP	30000	-	1000	:	:	:	IT0	1	3
3	I+200000	30000	-	1000	:	:	:	SEL1T0	1	0

Operating Procedure

- ① Turn ON the /MODE 0/1 signal to change to mode 0.
- ② Set the /SEL0 to /SEL7 signals to 0 to specify program step 0.
- ③ Turn ON the /START-STOP signal to start program table operation.
The /INPOSITION signal turns OFF.
- ④ After 2 seconds elapse, step 1 is executed.
- ⑤ When the /SEL0 signal turns ON, step 2 is executed.
- ⑥ After the motor decelerates to a stop, the /INPOSITION signal turns ON and step 3 is executed. At the start of execution, the /INPOSITION signal turns OFF.
- ⑦ When positioning is completed to the target position, the /INPOSITION signal turns ON.
- ⑧ When the /SEL1 signal turns ON, program step 3 is ended and program step 0 is executed.

Operation Pattern and Related Signal Timing

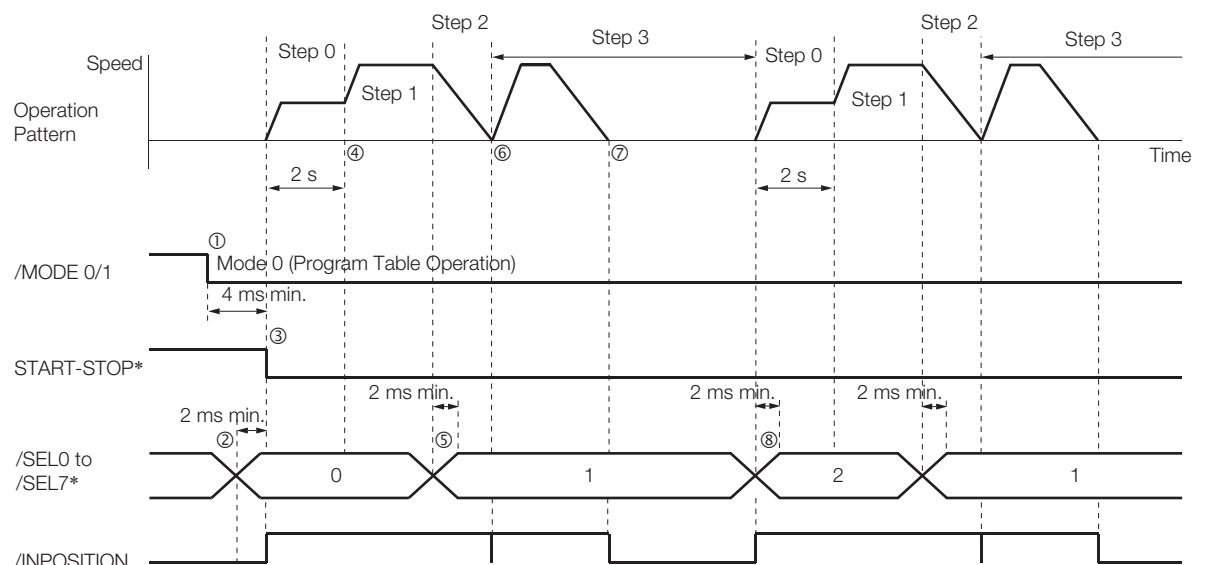

* Do not change /SEL0 to /SEL7 for 4 ms after turning ON the /START-STOP signal.

Performing Registration

This example shows how to use the /RGRT signal during execution of a program step to change to the specified speed and perform positioning for the specified distance.

When the /RGRT signal turns ON during step 0, positioning is performed for a travel distance (RDST) of 100,000 reference units.

The speed changes to 15,000,000 reference units/min (RSPD).

When the /RGRT signal turns ON during step 1, positioning is performed for a travel distance (RDST) of 100,000 reference units.

The speed changes to 15,000,000 reference units/min (RSPD).

The program table for this positioning is shown below.

PGM-STEP	POS	SPD	RDST	RSPD	ACC	DEC	POUT	EVENT	LOOP	NEXT
0	I+200000	30000	100000	15000	400000	200000	NNNNNNNN	ITO	1	1
1	I-200000	30000	100000	15000	:	:	:::~::~:	ITO	1	0

Operating Procedure

- ① Turn ON the /MODE 0/1 signal to change to mode 0.
- ② Set the /SEL0 to /SEL7 signals to 0 to specify program step 0.
- ③ Turn ON the /START-STOP signal to start program table operation.
The /INPOSITION signal turns OFF.
- ④ The /RGRT signal turns ON to perform registration operation.
The speed changes to the registration speed.
- ⑤ The /INPOSITION turns ON when positioning is completed for the registration distance.
- ⑥ When execution of program step 1 starts, the /INPOSITION signal turns OFF.

Information If the remaining distance to the target position is shorter than the registration distance (RDST) when the /RGRT signal turns ON, an E23A serial command not acknowledged response (A.AEF (Insufficient Registration Distance Alarm)) occurs, the servo is turned OFF, and program execution is stopped.

Operation Pattern and Related Signal Timing

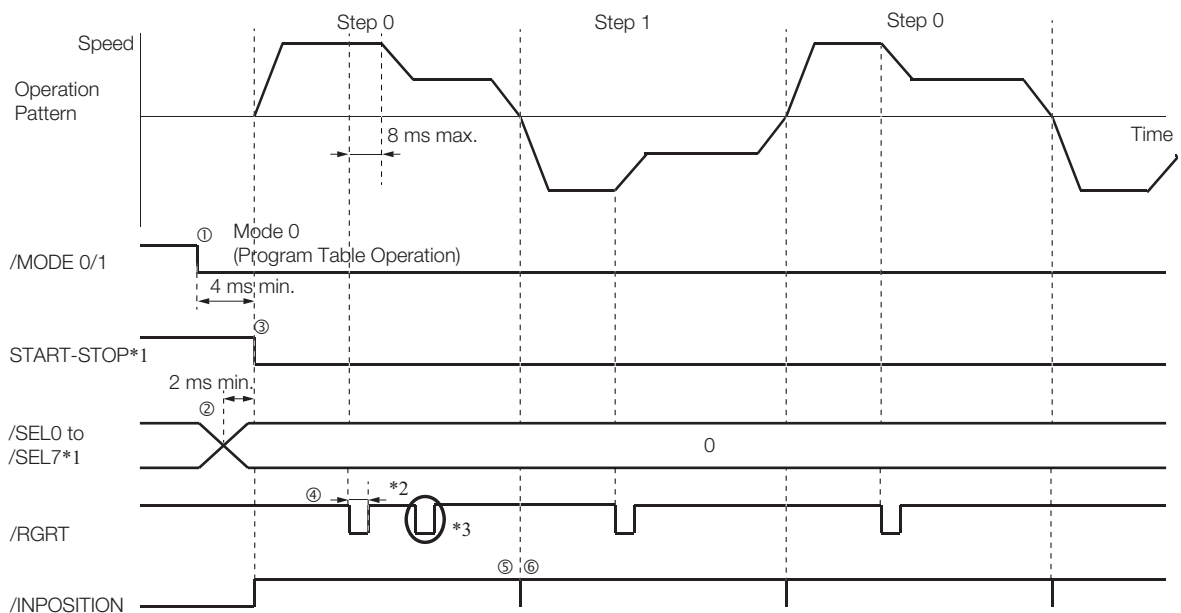

*1. Do not change /SEL0 to /SEL7 for 4 ms after turning ON the /START-STOP signal.

*2. PnB12 = 0 (Registration is started by changing the /RGRT signal from OFF (open) to ON (closed)): 20 μs min.
PnB12 = 1 (Registration is started by changing the /RGRT signal from ON (closed) to OFF (open)): 200 μs min.

*3. The /RGRT signal is ignored during registration operation.

Pausing Registration

This example shows how to turn OFF the /START-STOP signal to temporarily stop registration operation and then turn ON the /START-STOP signal to restart registration operation.

The program table for this positioning is shown below.

PGM-STEP	POS	SPD	RDST	RSPD	ACC	DEC	POUT	EVENT	LOOP	NEXT
0	I+200000	30000	100000	15000	400000	200000	NNNNNNNN	ITO	1	1
1	I-200000	30000	100000	15000	:	:	:::~::~:	ITO	1	END

- Operating Procedure
 - ① Turn ON the /MODE 0/1 signal to change to mode 0.
 - ② Set the /SEL0 to /SEL7 signals to 0 to specify program step 0.
 - ③ Turn ON the /START-STOP signal to start program table operation.
The /INPOSITION signal turns OFF.
 - ④ The /RGRT signal turns ON to perform registration operation.
The speed changes to the registration speed.
 - ⑤ Turn OFF the /START-STOP signal to stop operation.
 - ⑥ Turn ON the /START-STOP signal to restart program table operation.
 - ⑦ The /INPOSITION turns ON when positioning is completed for the remaining registration distance.
 - ⑧ When execution of program step 1 starts, the /INPOSITION signal turns OFF.
 - ⑨ The /RGRT signal turns ON to perform registration operation.
The speed changes to the registration speed.
 - ⑩ The /INPOSITION turns ON when positioning is completed for the registration distance.

- Operation Pattern and Related Signal Timing

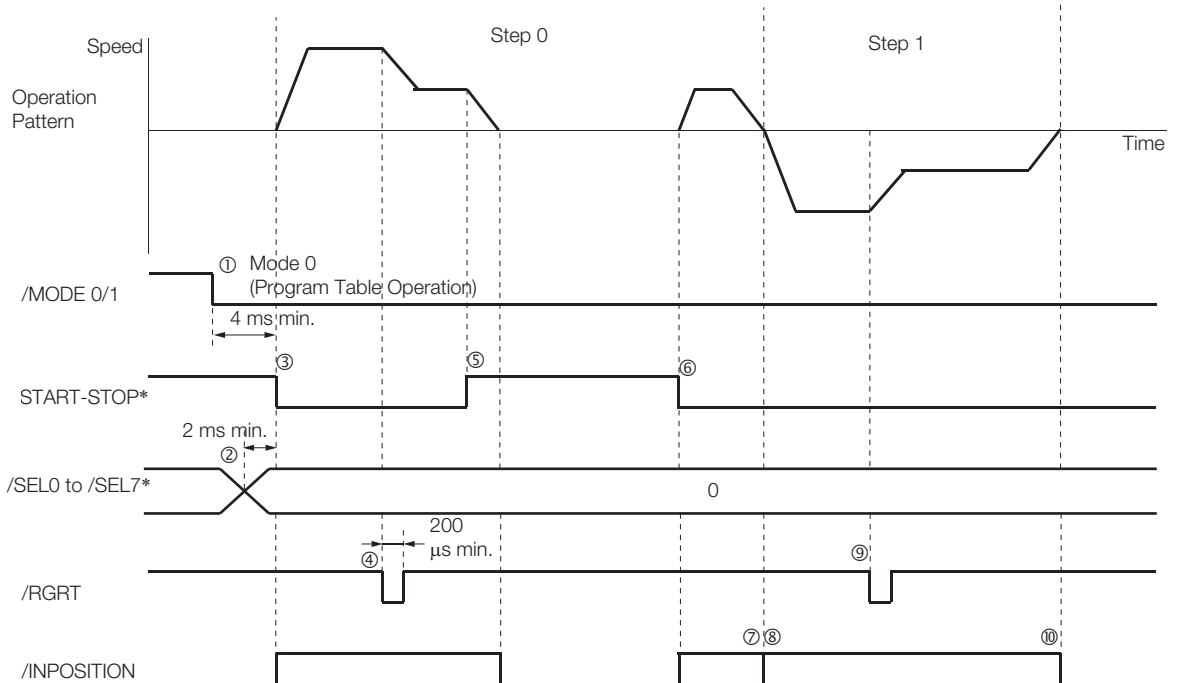

* Do not change /SEL0 to /SEL7 for 4 ms after turning ON the /START-STOP signal.

Turning ON the /RGRT Signal While Program Table Operation Is Stopped

This example shows what happens when the /RGRT signal is turned ON while program table operation is stopped after turning OFF the /START-STOP signal. In this case, registration operation is performed when the /START-STOP signal is turned ON.

The program table for this positioning is shown below.

PGM-STEP	POS	SPD	RDST	RSPD	ACC	DEC	POUT	EVENT	LOOP	NEXT
0	I+200000	30000	100000	15000	400000	200000	NNNNNNNN	ITO	1	1
1	I-200000	30000	100000	15000	:	:	:::~::~:	ITO	1	END

• Operating Procedure

- ① Turn ON the /MODE 0/1 signal to change to mode 0.
- ② Set the /SEL0 to /SEL7 signals to 0 to specify program step 0.
- ③ Turn ON the /START-STOP signal to start program table operation.
The /INPOSITION signal turns OFF.
- ④ Turn OFF the /START-STOP signal to stop operation.
- ⑤ The /RGRT signal turns ON to specify registration operation.
- ⑥ Turn ON the /START-STOP signal to restart program table operation.
In this case, registration operation is performed.
- ⑦ The /INPOSITION turns ON when positioning is completed for the registration distance.
- ⑧ When execution of program step 1 starts, the /INPOSITION signal turns OFF.
- ⑨ The /RGRT signal turns ON to perform registration operation.
The speed changes to the registration speed.
- ⑩ The /INPOSITION turns ON when positioning is completed for the registration distance.

• Operation Pattern and Related Signal Timing

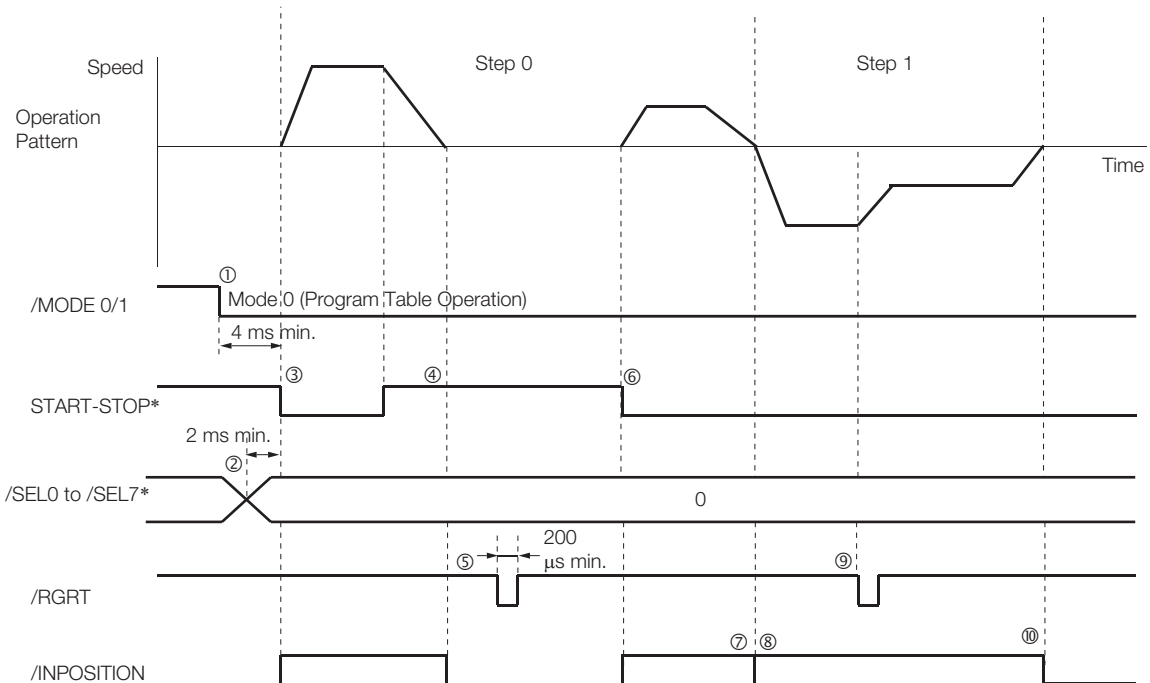

* Do not change /SEL0 to /SEL7 for 4 ms after turning ON the /START-STOP signal.

Using Consecutive Stops



Term

You can use consecutive stops to set the target position to infinite (+/-INFINITE) and then perform positioning from constant-speed operation to a specified absolute position within the rotational coordinates without stopping.

During positioning, the positioning speed (SPD) that is set for the previous program step is continued until the point where deceleration is started to position to the target position within the rotational coordinates without rotating in the reverse direction.

Note: Conditions for Using a Consecutive Stop

All of the following conditions must be met to use a consecutive stop.

If execution is attempted when any of the conditions is not met, an E53E (Movement Reference Duplication) or E63E (Consecutive Stop Execution Failure) error will occur.

Conditions:

- Rotational coordinates must be used (PnB20 = 1, 2, or 3).
- The target position (POS) in the previous program step must be infinite (\pm INFINITE).
- The target positions (POS) in the previous two program steps must not both be set to infinite (\pm INFINITE).
- Registration cannot be used in the previous program step.

A consecutive stop is used with a program step that is set for an infinite length and constant-speed operation.

In the following example, step 0 operates the motor for 2 seconds at a speed of 1,080,000,000 reference units/min and then execution moves to step 1. If the reference unit is set to 0.001 deg, then the speed would be 1,080 deg/min.

Step 1 continues operation at the positioning speed (SPD) specified for step 0 and performs positioning to a target position of 45,000 reference units (45 deg). The rotation direction is not reversed.

The program table for this positioning is shown below.

PGMSTEP	POS	SPD	RDST	RSPD	ACC	DEC	POUT	EVENT	LOOP	NEXT
0	+INFINITE	1080000	-	1000	1080	1080	NNNNNNNA	T2000	1	1
1	S+45000	1000	-	1000	1080	1080	NNNNNNAN	ITO	1	END

Note: 1. If a consecutive stop is specified for the target position (POS), the setting of the deceleration rate (DEC) in the previous program step is disabled.

2. If INFINITE is specified for the target position (POS), always set the number of loops setting (LOOP) to 1.

3. If a consecutive stop is specified for the target position (POS), always set the number of loops setting (LOOP) to 1.

4. If a consecutive stop is specified for the target position (POS), the settings of the positioning speed (SPD) and acceleration rate (ACC) are ignored. The values that were specified in the previous program step are used.

• Operating Procedure

- ① Turn ON the /MODE 0/1 signal to change to mode 0.
- ② Set the /SEL0 to /SEL7 signals to 0 to specify program step 0.
- ③ Turn ON the /START-STOP signal to start program table operation.
The /INPOSITION signal turns OFF and the /POUT0 signal turns ON.
- ④ After 2 seconds elapse, step 1 is executed.
The /POUT0 signal turns OFF and the /POUT1 signal turns ON.
- ⑤ When positioning is completed to the target position (45 deg = 45,000 reference units), the /INPOSITION signal turns ON.

13.3 Program Table Operation

13.3.8 Program Table Operation Examples

- Operation Pattern and Related Signal Timing

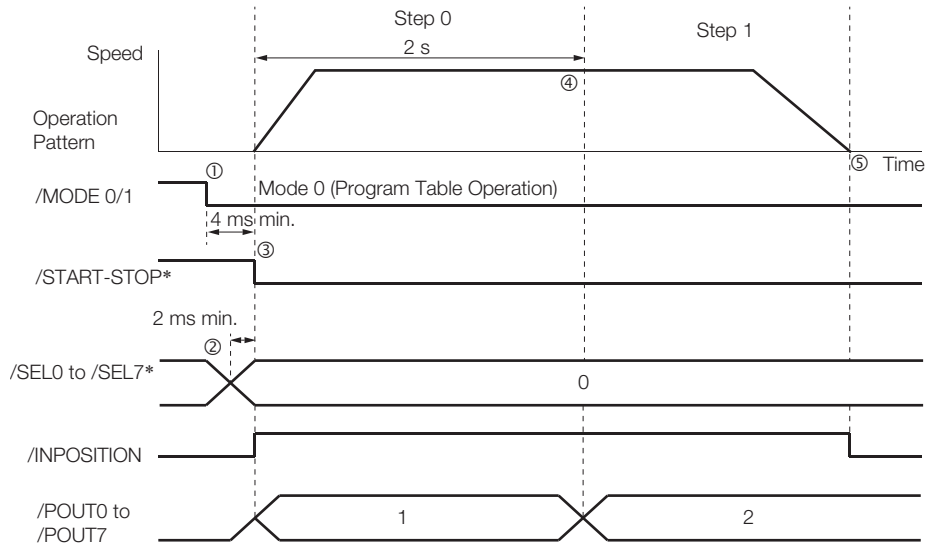

* Do not change /SEL0 to /SEL7 for 4 ms after turning ON the /START-STOP signal.

Resetting Program Table Operation

In this example, program operation is reset during repeated operation of program steps 0 and 1 and then the program step is specified and operation is restarted from the canceled state.

Note: "Canceled" is the state in which the mode is mode 0, execution is not in a stopped state, and no program step has been executed.

Step 0 performs relative positioning for 100,000 reference units at a speed of 15,000,000 reference units/min. The acceleration rate is 400,000,000 reference units/min/ms and the deceleration rate is 200,000,000 reference units/min/ms.

Step 1 performs relative positioning for 100,000 reference units at a speed of 30,000,000 reference units/min. The acceleration rate is 400,000,000 reference units/min/ms and the deceleration rate is 200,000,000 reference units/min/ms.

The program table for this positioning is shown below.

PGM-STEP	POS	SPD	RDST	RSPD	ACC	DEC	POUT	EVENT	LOOP	NEXT
0	I+100000	15000	-	1000	400000	200000	NNNNN- NNN	IT1000	1	1
1	I-100000	30000	-	1000	400000	200000	NNNNN- NNN	IT1000	1	0

• Operating Procedure

- ① Turn ON the /MODE 0/1 signal to change to mode 0.
- ② Set the /SEL0 to /SEL7 signals to 0 to specify program step 0.
- ③ Turn ON the /START-STOP signal to start program table operation.
- ④ Turn OFF the /START-STOP signal to stop program table operation.
- ⑤ Turn ON the /PGMRES signal to cancel program table operation.
- ⑥ Set the /SEL0 to /SEL7 signals to 1 (i.e., turn ON /SEL0) to specify program step 1.
- ⑦ Turn ON the /START-STOP signal to start program table operation.
- ⑧ When positioning is completed to the target position, the /INPOSITION signal turns ON.

• Operation Pattern and Related Signal Timing

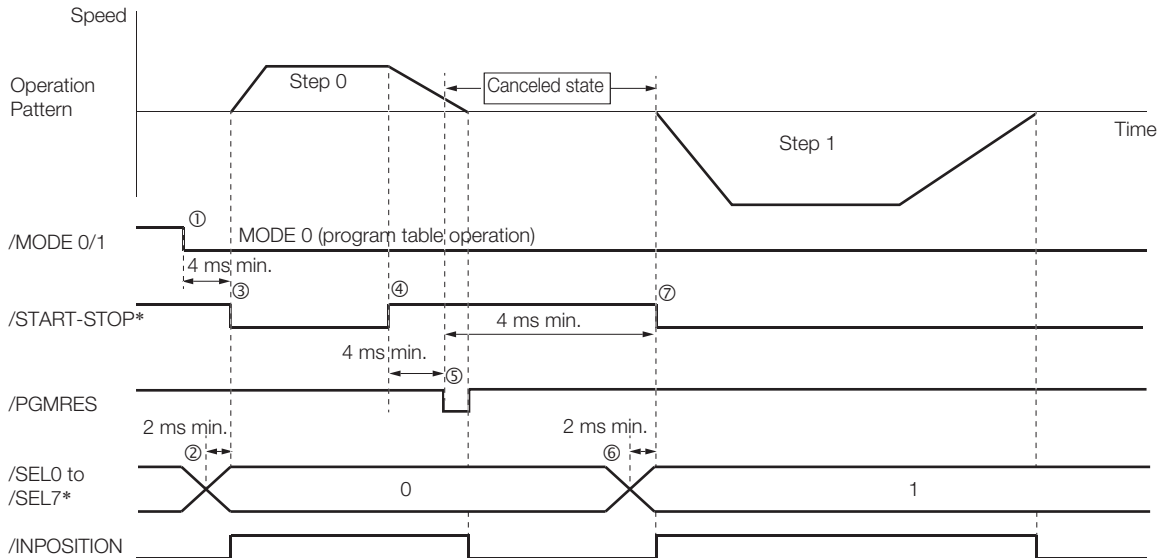

* Do not change /SEL0 to /SEL7 for 4 ms after turning ON the /START-STOP signal.

13.3.9 EVENT Examples

This section provides examples of the settings and operations for the EVENT end conditions for program steps.

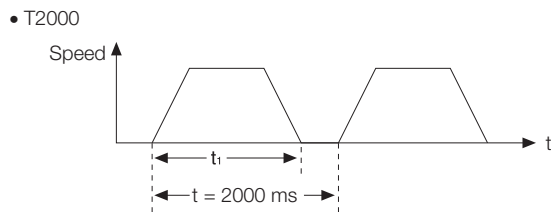
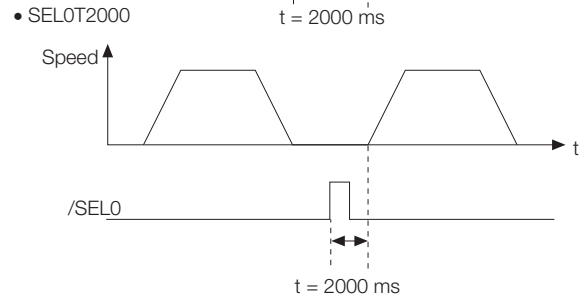
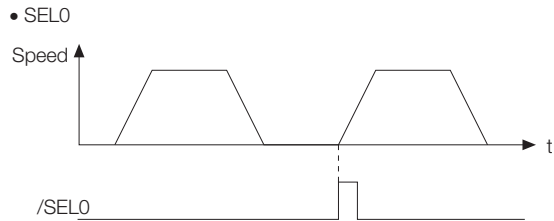
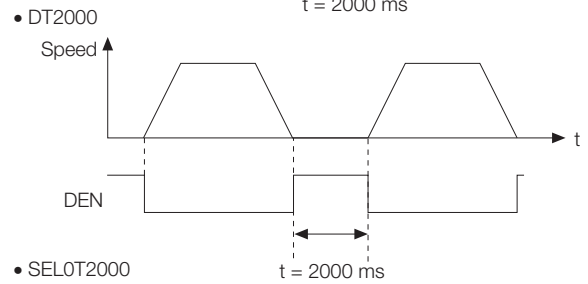
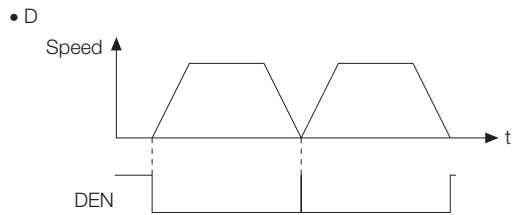
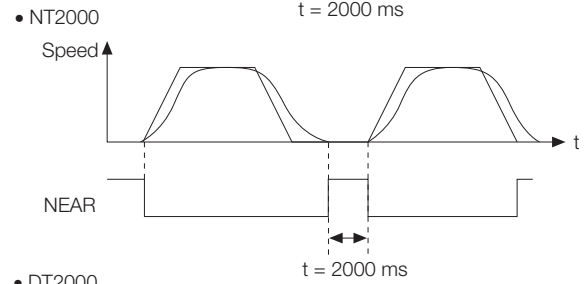
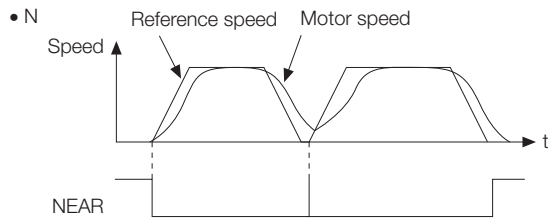
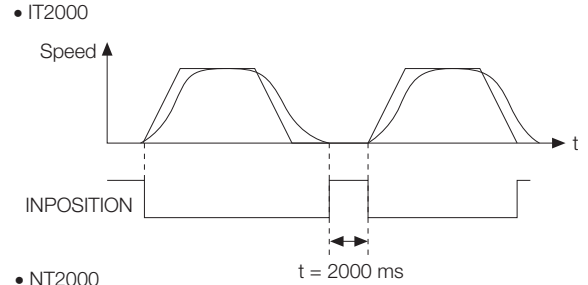
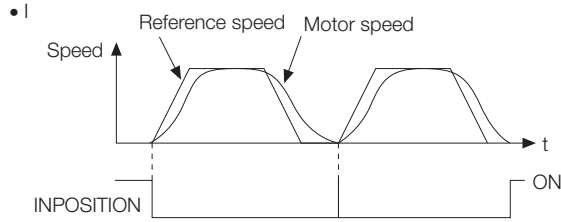

Note: If $t < t_1$, an error (E53E) will occur and program table operation will be stopped.

13.3.10 Output Response Times after /START-STOP Turns ON

The response times for starting the Servomotor, the /INPOSITION signal, and the /POUT0 to /POUT7 signals when the /START-STOP signal is turned ON to start program table operation are shown below.

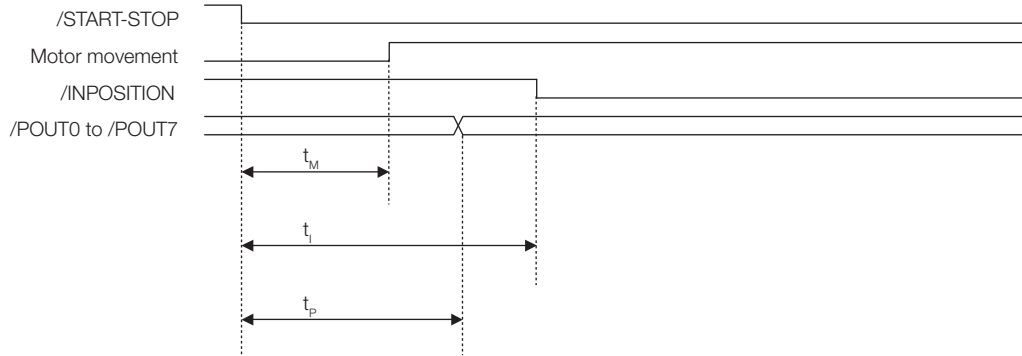

Response Times	
t_M	6 ms max.
t_I	8 ms max.
t_P	6 ms max.

Note: In the following cases, the response times can be as long as 16 ms max.

- When program table operation is stopped (including when it is stopped for an error)
- When the motor stops due to overtravel

13.4 Jog Speed Table Operation

You can perform jog operation from the SigmaWin+, or you can use the /JOGP and /JOGN input signals to perform jog operation. Jog operation is performed at the specified jog speed.

13.4.1 Input Signals Related to Jog Operation

The following signals are used for jog operation: /MODE 0/1, /JOGP, /JOGN, and /JOG0 to /JOG3.

Turn OFF the /MODE 0/1 signal to change to mode 1. Use the /JOGP signal as the command for forward jog operation and the /JOGN signal as the command for reverse jog operation.

Input Signal	Description	Reference
/MODE 0/1	ON: Mode 0 (program table operation) OFF: Mode 1 (jog speed table operation or homing)	page 6-4
/JOGP	Turn this signal ON to jog forward at the jog speed registered in the jog speed table. The motor is accelerated according to PnB29 (Acceleration Rate). When this signal turns OFF, the motor is decelerated to a stop according to PnB2B (Deceleration Rate).	page 6-6
/JOGN	Turn this signal ON to jog in reverse at the jog speed registered in the jog speed table. The motor is accelerated according to PnB29 (Acceleration Rate). When this signal turns OFF, the motor is decelerated to a stop according to PnB2B (Deceleration Rate).	page 6-6
/JOG0 to /JOG3	Use these signals to specify a jog speed that is registered in the jog speed table.	page 6-6



Turn ON only one of the following signals at the same time: /HOME, /JOGP, and /JOGN. Otherwise, the command will be disabled and no operation will be performed. To jog the motor, turn ON either the /JOGP or /JOGN signal.

13.4.2 Jog Speeds

You set the jog speeds in the Jog Speed Table Editing Dialog Box on the SigmaWin+. You can register up to 16 jog speeds in JSPD0 to JSPD15 in the jog speed table.

The specifications for the jog speeds are given in the following table.

Jog Speed	Setting Range	Setting Unit	Default Setting	When Enabled
	1 to 99,999,999*	1,000 reference units/min	1,000	Immediately

* If you set PnB54 to 1 (Enable Expansion Mode), the range will be 1 to 199,999,999. Refer to the following section for details.

 [12.4 Speed/Position Expansion Function Setting on page 12-8](#)

Note: Edit the jog speed table only when the Servomotor is stopped.

13.4.3 Jog Speed Table and Speed Selection Signals

You can register up to 16 jog speeds in the jog speed table.

The /JOG0 to /JOG3 (Jog Speed Selection) signals are used to specify the jog speeds that are registered in the jog speed table.

Jog Speed Table		Jog Speed Selection Signals			
JSPD	Jog Speed* (1,000 reference units/min)	/JOG3	/JOG2	/JOG1	/JOG0
0	±nnnnnnnn	0	0	0	0
1	±nnnnnnnn	0	0	0	1
2	±nnnnnnnn	0	0	1	0
3	±nnnnnnnn	0	0	1	1
4	±nnnnnnnn	0	1	0	0
5	±nnnnnnnn	0	1	0	1
6	±nnnnnnnn	0	1	1	0
7	±nnnnnnnn	0	1	1	1
8	±nnnnnnnn	1	0	0	0
9	±nnnnnnnn	1	0	0	1
10	±nnnnnnnn	1	0	1	0
11	±nnnnnnnn	1	0	1	1
12	±nnnnnnnn	1	1	0	0
13	±nnnnnnnn	1	1	0	1
14	±nnnnnnnn	1	1	1	0
15	±nnnnnnnn	1	1	1	1

* If you set PhB54 to 1 (Enable Expansion Mode), the range will be ±nnnnnnnnn. Refer to the following section for details.

 [12.4 Speed/Position Expansion Function Setting on page 12-8](#)

Note: 1: Signal is ON (active), 0: Signal is OFF (inactive).

13.4.4 SigmaWin+ Procedures

You use the SigmaWin+ to edit, write, and save the jog speed table.

Use the following flow.

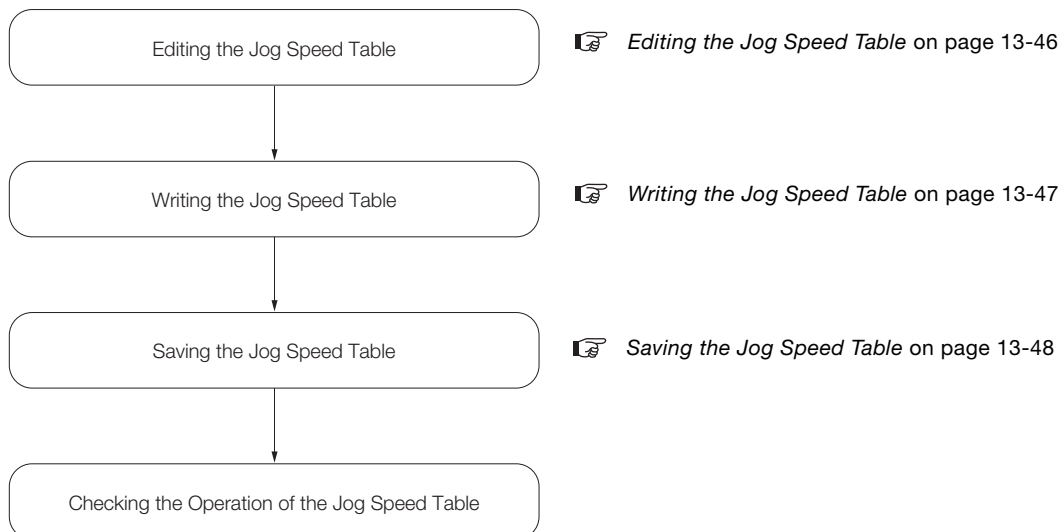

Editing the Jog Speed Table

◆ Displaying the Jog Speed Table Editing Dialog Box

Select **Edit Jog Speed Table** in the Menu Dialog Box of the SigmaWin+.

◆ Details on the Jog Speed Table Editing Dialog Box

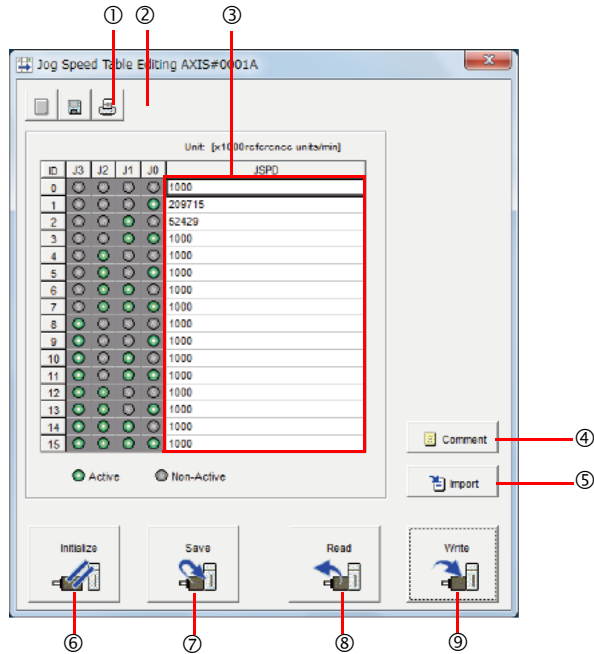

No.	Item	Description
①	Save Button	Saves the currently displayed settings to a computer file.
②	Print Button	Prints the currently displayed settings.
③	Setting Area	Set the jog speeds. Select the cell and enter the value directly.
④	Comment Button	Lets you add a comment.
⑤	Import Button	Imports a jog speed table from a file saved on the computer to the SigmaWin+.
⑥	Initialize Button	Initializes the flash memory in the SERVOPACK.
⑦	Save Button	Saves the settings in the SERVOPACK to flash memory.
⑧	Read Button	Reads the settings in the SERVOPACK to the SigmaWin+.
⑨	Write Button	Writes the currently displayed settings to the SERVOPACK.

Writing the Jog Speed Table

You can write the edited jog speed table to SERVOPACK RAM to operate the SERVOPACK according to the program.



Note

1. Make sure that the system is in SERVO OFF state when you write the jog speed table.
2. The jog speed table that is written will be deleted when the power supply to the SERVOPACK is turned OFF.

Before you turn OFF the power supply to the SERVOPACK, save the jog speed table from RAM to flash memory. Refer to the following section for the operating procedure.

Saving the Jog Speed Table on page 13-48

1. Click the Write Button on the Jog Speed Table Editing Dialog Box.

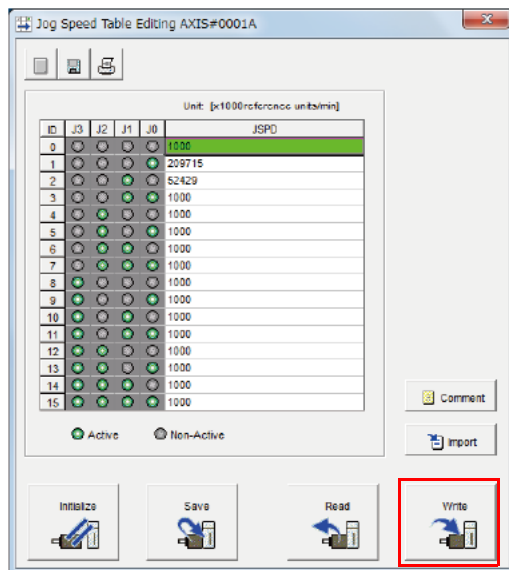

The Write Dialog Box will be displayed.

2. Click the OK Button.



The jog speed table edited on the SigmaWin+ will be written to the SERVOPACK and the edited cells will change to white.

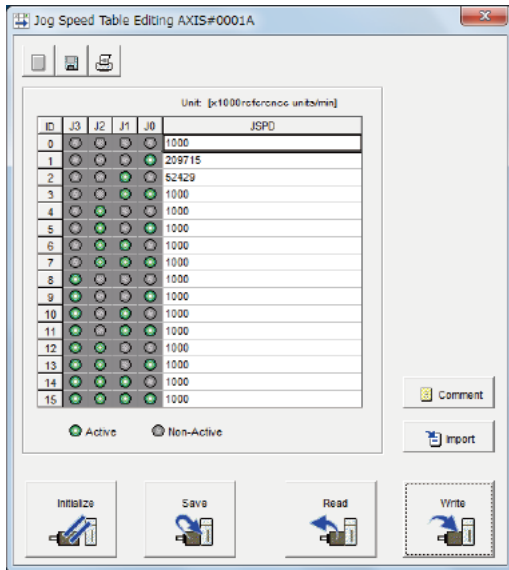

This concludes the writing procedure.

Saving the Jog Speed Table

◆ Saving the Jog Speed Table to Flash Memory in the SERVOPACK

To prevent the jog speed table from being deleted when the power supply to the SERVOPACK is turned OFF, you must save it to flash memory in the SERVOPACK. The jog speed table that is saved in the flash memory is automatically loaded each time the power supply is turned ON. There are the following three ways to save the jog speed table to flash memory in the SERVOPACK.

- Save it from the Jog Speed Table Editing Dialog Box.
- Save it with the JSPDSTORE serial command.
- Save it with FnB05 (Edit/Save Jog Speed Table) on a Digital Operator.

Use the following procedure to save the jog speed table from the Jog Speed Editing Dialog Box.

1. Click the **Save** Button on the Jog Speed Table Editing Dialog Box.

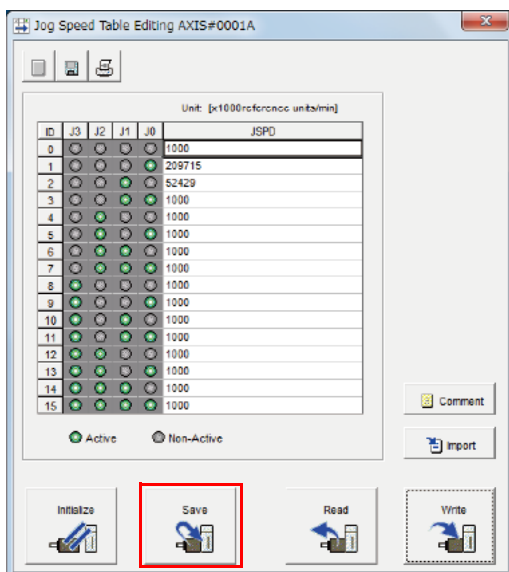

The Save Table Dialog Box will be displayed.

2. Click the OK Button.

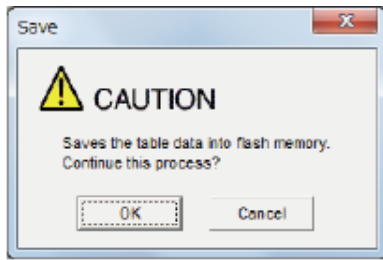

This concludes the saving procedure.

◆ Saving the Jog Speed Table to a Computer File

You can save the jog speed table to a file on the computer. Use computer files to back up jog speed tables.

1. Click the **Save** Button.

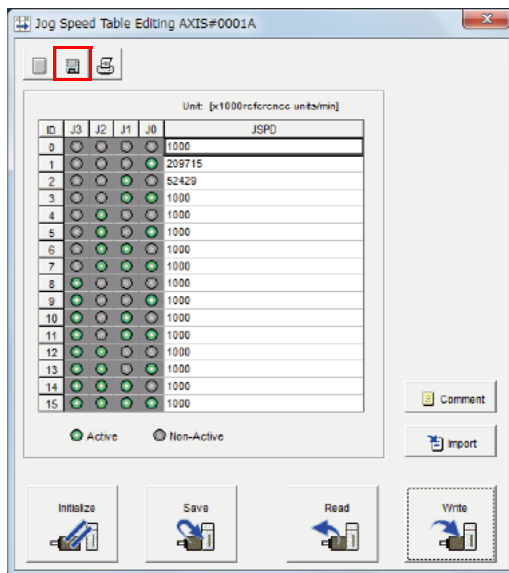

The Open Dialog Box will be displayed.

2. Specify the save location and file name.

You can set any file name. However, you cannot change the file name extension.

Information You can also set a comment.

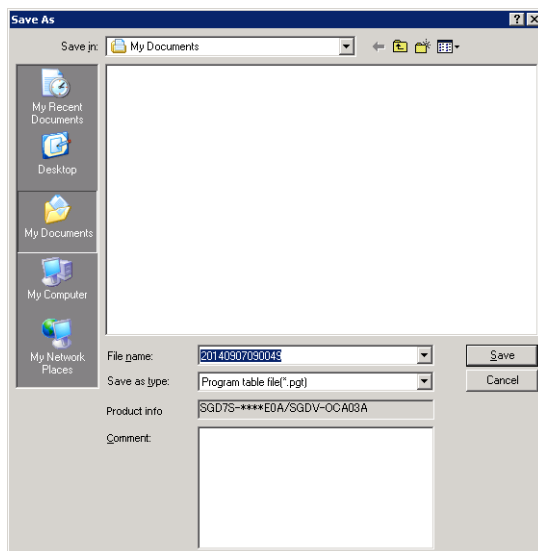

13.4 Jog Speed Table Operation

13.4.5 Jog Speed Table Operation Example

Information You can use the **Import** Button to load the jog speed table saved in a file to the SERVO-PACK.

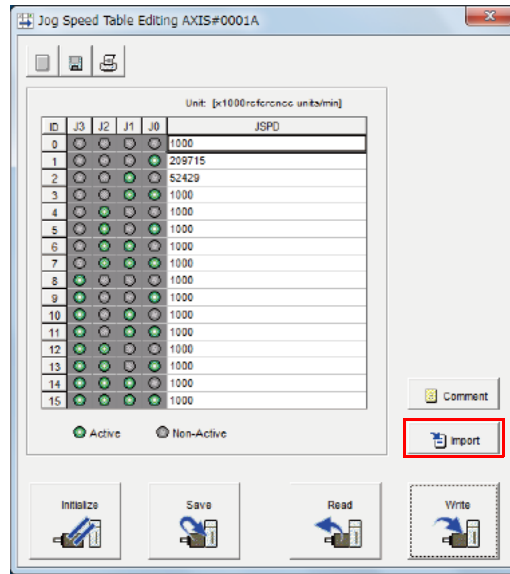

This concludes the saving procedure.

13.4.5 Jog Speed Table Operation Example

This example shows how to perform operation by using the /JOG0 to /JOG3 (Jog Speed Selection) signals to specify the jog speeds that are registered in the jog speed table.

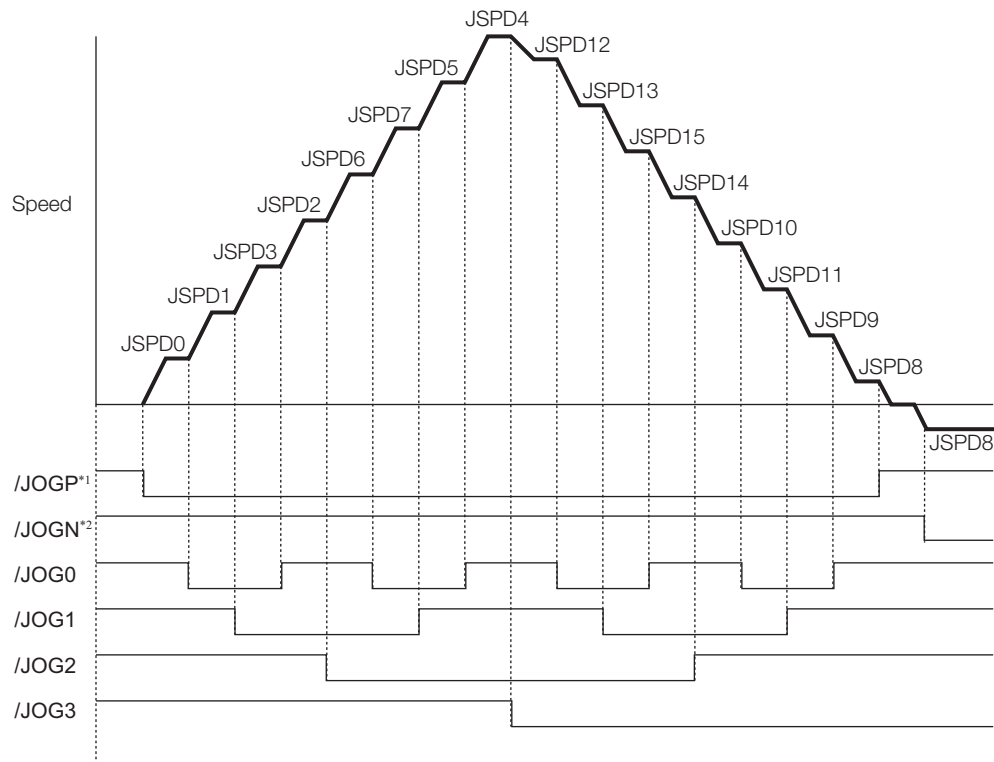

*1. Forward operation at the jog speed is performed while the /JOGP signal is ON.

*2. Reverse operation at the jog speed is performed while the /JOGN signal is ON.

13.4.6 Timing of Signal Changes

The timing of the /MODE 0/1 and /JOGP signals, the /MODE 0/1 and /JOGN signals, and the /HOME, /JOGP, and /JOGN signals is shown below.

To start jog operation, turn OFF the /MODE 0/1 signal, wait for at least 4 ms, and then turn ON the /JOGP or /JOGN signal.

To change to mode 0, turn OFF the /JOGP or /JOGN signal and then turn OFF the /MODE 0/1 signal. The timing is shown below.

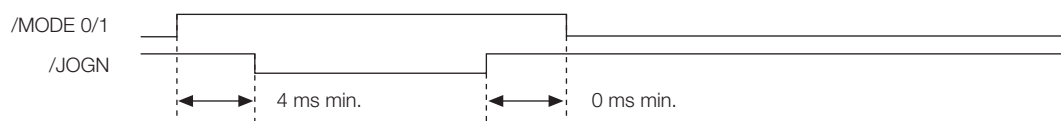
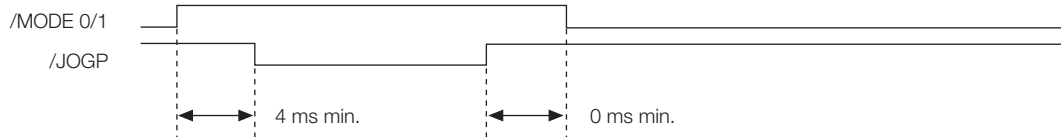

If you have performed homing, turn OFF the /HOME signal, wait for at least 4 ms, and then turn ON the /JOGP or /JOGN signal. When jog operation in both directions, allow at least 4 ms between the /JOGP and /JOGN signals. The timing is shown below.

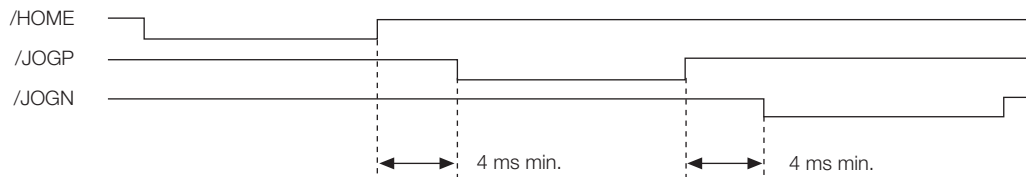

13.5 ZONE Outputs

You can use ZONE signals to output a ZONE number to indicate when the current value is within a registered zone.

The ZONE signals (/Z0 to /Z4) are assigned to output signals /POUT0 to /POUT4 on CN11.

13.5.1 ZONE Table and ZONE Signals

You can register the desired zones in the ZONE table. The ZONE table consists of settings for the ZONE numbers (ZONE), ZONE N values (ZONE N), and ZONE P values (ZONE P). You can register up to 32 zones.

The ZONE numbers identify the registered zones.

ZONE N is the lower limit of the ZONE and ZONE P is the upper limit of the ZONE. The setting conditions for ZONE N and ZONE P are given in the following table.

Setting Range	Setting Unit	Default Setting	When Enabled
-99,999,999 to 99,999,999*	1 reference unit	0	Immediately

* If you set PnB54 to 1 (Enable Expansion Mode), the range will be -1,073,741,823 to +1,073,741,823. Refer to the following section for details.

 12.4 Speed/Position Expansion Function Setting on page 12-8

The ZONE signals indicate the ZONE number. If the current value is within a zone registered in the ZONE table, the corresponding ZONE number is output on the ZONE signals.

You can use the ZONE numbers as required, e.g., to trigger operations related to positioning.

ZONE Table			ZONE Signals				
ZONE Number (ID)	ZONE N* [Reference Units]	ZONE P* [Reference Units]	/Z4 (/POUT4)	/Z3 (/POUT3)	/Z2 (/POUT2)	/Z1 (/POUT1)	/Z0 (/POUT0)
0	±nnnnnnnn	±nnnnnnnn	0	0	0	0	0
1	±nnnnnnnn	±nnnnnnnn	0	0	0	0	1
2	±nnnnnnnn	±nnnnnnnn	0	0	0	1	0
3	±nnnnnnnn	±nnnnnnnn	0	0	0	1	1
4	±nnnnnnnn	±nnnnnnnn	0	0	1	0	0
5	±nnnnnnnn	±nnnnnnnn	0	0	1	0	1
6	±nnnnnnnn	±nnnnnnnn	0	0	1	1	0
7	±nnnnnnnn	±nnnnnnnn	0	0	1	1	1
8	±nnnnnnnn	±nnnnnnnn	0	1	0	0	0
9	±nnnnnnnn	±nnnnnnnn	0	1	0	0	1
10	±nnnnnnnn	±nnnnnnnn	0	1	0	1	0
11	±nnnnnnnn	±nnnnnnnn	0	1	0	1	1
12	±nnnnnnnn	±nnnnnnnn	0	1	1	0	0
13	±nnnnnnnn	±nnnnnnnn	0	1	1	0	1
14	±nnnnnnnn	±nnnnnnnn	0	1	1	1	0
15	±nnnnnnnn	±nnnnnnnn	0	1	1	1	1
16	±nnnnnnnn	±nnnnnnnn	1	0	0	0	0
17	±nnnnnnnn	±nnnnnnnn	1	0	0	0	1
18	±nnnnnnnn	±nnnnnnnn	1	0	0	1	0
19	±nnnnnnnn	±nnnnnnnn	1	0	0	1	1
20	±nnnnnnnn	±nnnnnnnn	1	0	1	0	0
21	±nnnnnnnn	±nnnnnnnn	1	0	1	0	1
22	±nnnnnnnn	±nnnnnnnn	1	0	1	1	0
23	±nnnnnnnn	±nnnnnnnn	1	0	1	1	1

Continued on next page.

Continued from previous page.

ZONE Table			ZONE Signals				
ZONE Number (ID)	ZONE N* [Reference Units]	ZONE P* [Reference Units]	/Z4 (/POUT4)	/Z3 (/POUT3)	/Z2 (/POUT2)	/Z1 (/POUT1)	/Z0 (/POUT0)
24	±nnnnnnnn	±nnnnnnnn	1	1	0	0	0
25	±nnnnnnnn	±nnnnnnnn	1	1	0	0	1
26	±nnnnnnnn	±nnnnnnnn	1	1	0	1	0
27	±nnnnnnnn	±nnnnnnnn	1	1	0	1	1
28	±nnnnnnnn	±nnnnnnnn	1	1	1	0	0
29	±nnnnnnnn	±nnnnnnnn	1	1	1	0	1
30	±nnnnnnnn	±nnnnnnnn	1	1	1	1	0
31	±nnnnnnnn	±nnnnnnnn	1	1	1	1	1

* If you set PnB54 to 1 (Enable Expansion Mode), the range will be ±nnnnnnnnnn. Refer to the following section for details.

 **12.4 Speed/Position Expansion Function Setting on page 12-8**

Note: 1: Signal is ON (active), 0: Signal is OFF (inactive).



Always save the ZONE table to flash memory after you edit it. Refer to the following section for the procedure.

 **Saving the Program Table to Flash Memory in the SERVOPACK on page 13-24**

Note

If you turn OFF the power supply before you save changes to flash memory, the changes to the ZONE table will be lost.

ZONE Table Settings and ZONE Numbers

The relationship between the ZONE table settings and the ZONE numbers is shown below.

- **ZONE N ≤ ZONE P**

The ZONE signals for the corresponding ZONE number is output if the current value is between ZONE N and ZONE P, inclusive (the shaded part in the following figure).



- **ZONE P ≤ ZONE N**

The ZONE signals for the corresponding ZONE number is output if the current value is less than or equal to ZONE P or greater than or equal to ZONE N (the shaded parts in the following figure).



- **Duplicated Settings in the ZONE Table**

The smaller ZONE number is output.

- **ZONE N and ZONE P = 0**

The ZONE number is disabled.

- **When the Current Value Is Not In Any ZONE**

All of the ZONE signals will be OFF (0).

13.5.2 Parameters Related to ZONE Signals

With the following parameter, the initial status* of the programmable output signals (/POUT0 to /POUT7) can be set to ZONE signals.

The initial status is the status that exists after the control power supply is turned ON or after resetting the SERVOPACK.

Parameter		Meaning	When Enabled	Classification
PnB4F	0000h (default setting)	When the control power supply is turned ON or the SERVOPACK is reset, the /POUT0 to /POUT7 signals are turned OFF.	After restart	Setup
	0001h	When control power is turned ON or SERVOPACK is reset, signals /POUT0 to 7 are ZONE signals.		

Note: You can set the ZONE signals for /POUT5 to /POUT7, but the outputs will always be OFF.

13.5.3 SigmaWin+ Procedures

You use the SigmaWin+ to edit, write, and save the ZONE table.

Use the following flow.

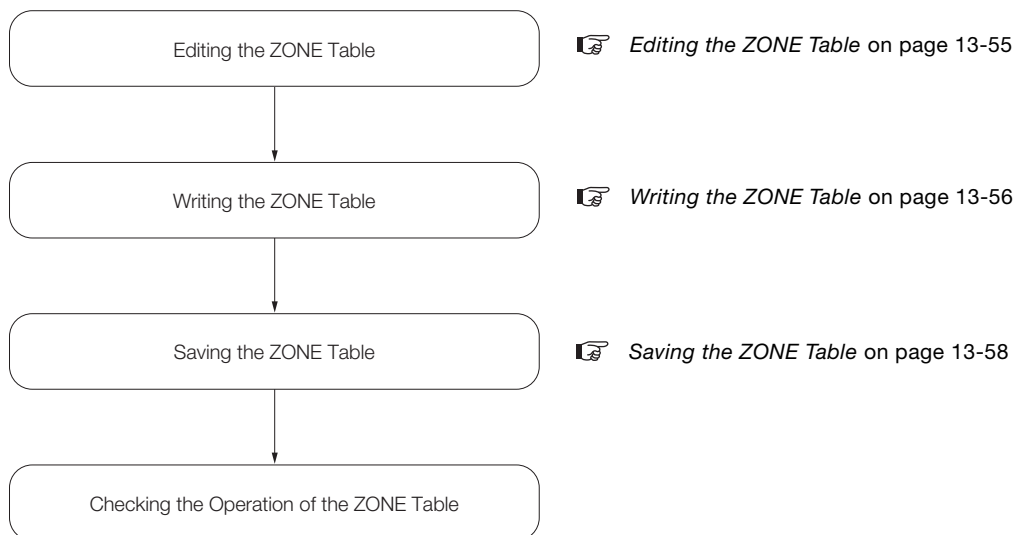

Editing the ZONE Table

◆ Displaying the Zone Table Editing.

Select **Zone Table Editing** in the Menu Dialog Box of the SigmaWin+.

◆ Details on the Zone Table Editing

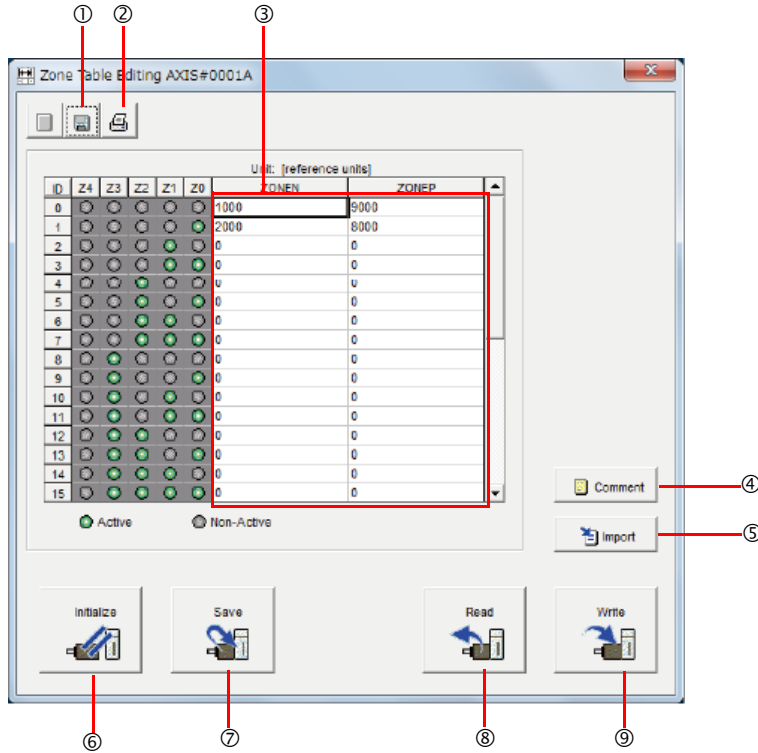

No.	Name	Description
①	Save Button	Saves the currently displayed settings to a computer file.
②	Print Button	Prints the currently displayed settings.
③	Setting Area	Sets the ranges for ZONE outputs. Select the cell and enter the value directly.
④	Comment Button	Lets you add a comment.
⑤	Import Button	Imports a ZONE table from a file saved on the computer to the SigmaWin+.
⑥	Initialize Button	Initializes the flash memory in the SERVOPACK.
⑦	Save Button	Saves the settings in the SERVOPACK to flash memory.
⑧	Read Button	Reads the settings in the SERVOPACK to the SigmaWin+.
⑨	Write Button	Writes the currently displayed settings to the SERVOPACK.

Writing the ZONE Table

You can write the edited ZONE table to SERVOPACK RAM to operate the SERVOPACK according to the program.



Note

1. Make sure that the system is in SERVO OFF state when you write the ZONE table.
2. The ZONE table that is written will be deleted when the power supply to the SERVOPACK is turned OFF.
 Before you turn OFF the power supply to the SERVOPACK, save the ZONE table from RAM to flash memory. Refer to the following section for the operating procedure.
 *Saving the ZONE Table* on page 13-58

1. Click the Write Button on the Zone Table Editing.

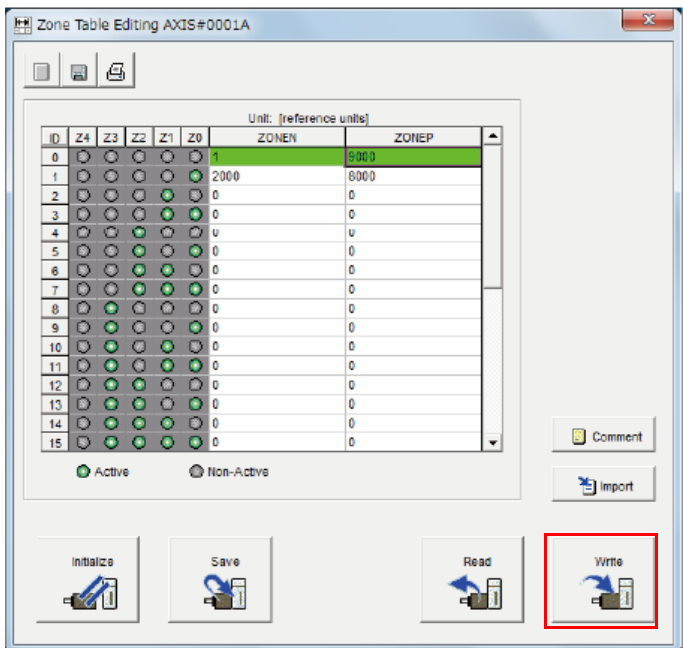

The Write Dialog Box will be displayed.

2. Click the OK Button.

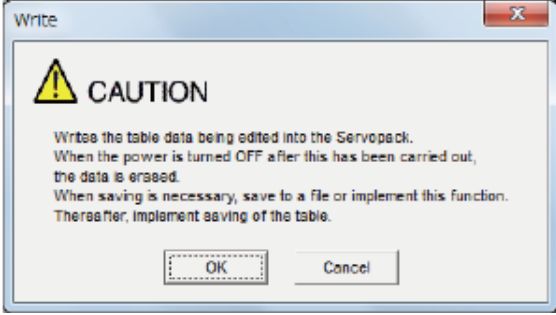

The ZONE table edited on the SigmaWin+ will be written to the SERVOPACK and the edited cells will change to white.

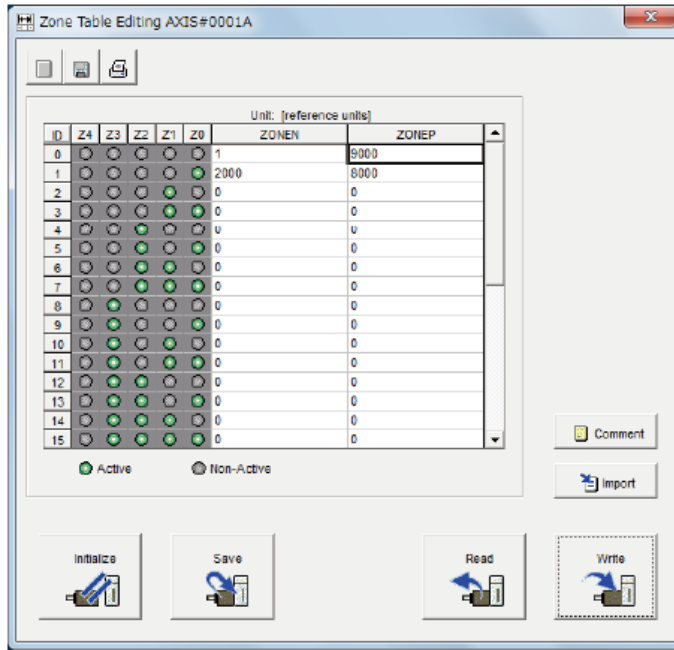

This concludes the writing procedure.

Saving the ZONE Table

◆ Saving the ZONE Table to Flash Memory in the SERVOPACK

To prevent the ZONE table from being deleted when the power supply to the SERVOPACK is turned OFF, you must save it to flash memory in the SERVOPACK. The ZONE table that is saved in the flash memory is automatically loaded each time the power supply is turned ON. There are the following three ways to save the ZONE table to flash memory in the SERVOPACK.

- Save it on the Zone Table Editing.
- Save it with the ZONESTORE serial command.
- Save it with FnB04 (Edit/Save ZONE Table) on a Digital Operator.

Use the following procedure to save the ZONE table from the Zone Table Editing.

1. Click the **Save Button** on the Zone Table Editing.

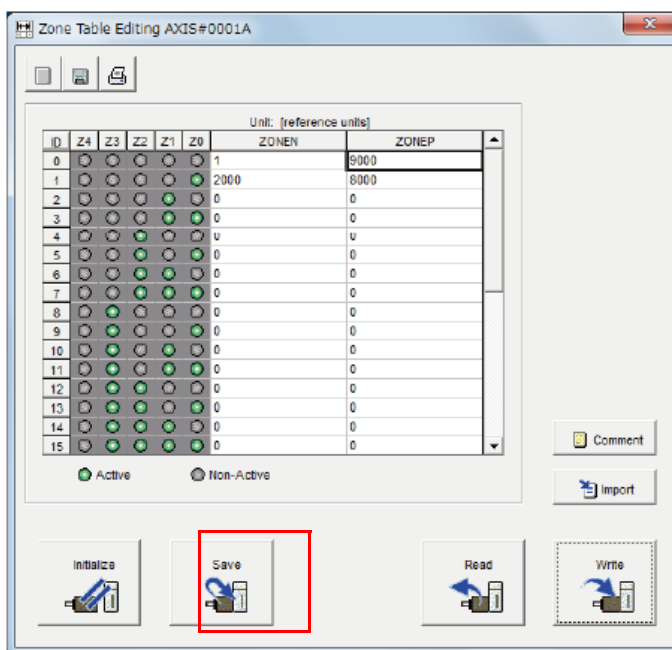

The Save Table Dialog Box will be displayed.

2. Click the **OK Button**.

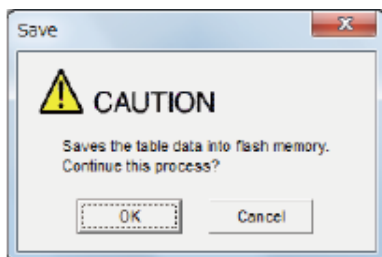

This concludes the saving procedure.

◆ **Saving the ZONE Table to a Computer File**

You can save the ZONE table to a file on the computer. Use computer files to back up ZONE tables.

1. Click the **Save Button**.

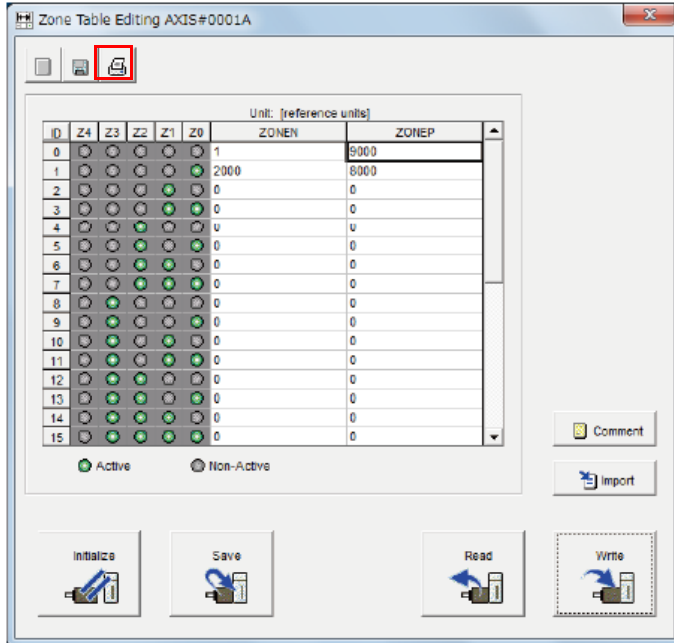

The Open Dialog Box will be displayed.

2. **Specify the save location and file name.**

You can set any file name. However, you cannot change the file name extension.

Information You can also set a comment.

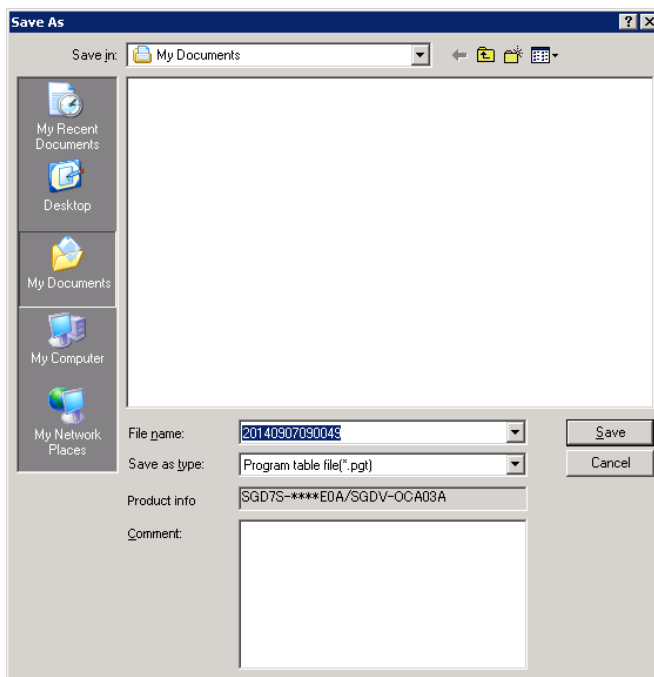

Information You can use the **Import** Button to load the program table saved in a file to the SERVO-PACK.

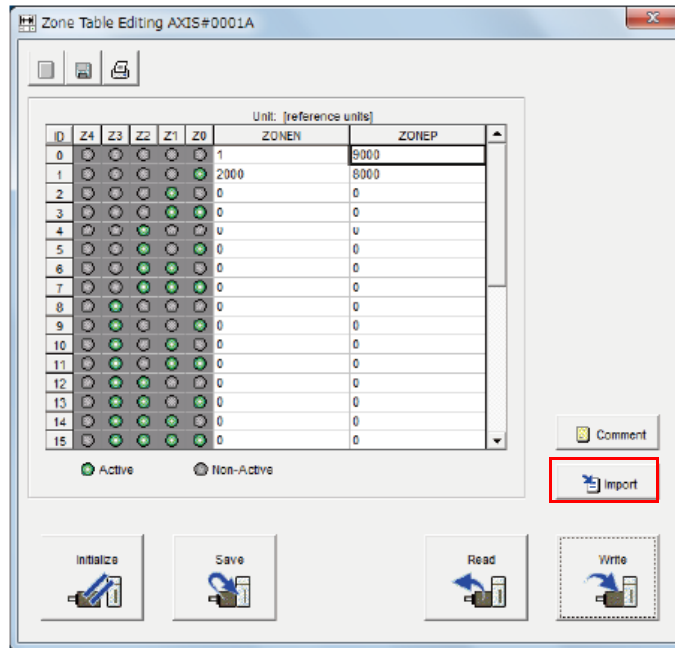

This concludes the saving procedure.

13.5.4 ZONE Output Application Example

Using the ZONE Outputs as Zone Signals

In this example, the motor is moved with program step operation and ZONE numbers are output when the current value enters a registered zone. You can use the ZONE numbers as zone signals for each zone, e.g., to trigger operations related to positioning.

Assume that the program table consists of the following five steps.

PGMSTEP	POS	SPD	RDST	RSPD	ACC	DEC	POUT	EVENT	LOOP	NEXT
0	A+000000	30000	-	1000	40000 0	200000	NNNZZZZZ	IT0	1	END
1	A+100000	30000	-	1000	:	:	NNNZZZZZ	IT0	1	END
2	A+200000	30000	-	1000	:	:	NNNZZZZZ	IT0	1	END
3	A+300000	30000	-	1000	:	:	NNNZZZZZ	IT0	1	END
4	A+400000	30000	-	1000	:	:	NNNZZZZZ	IT0	1	END

The ZONE table is shown below.

ZONE Number (ID)	ZONE N	ZONE P
0	0	0
1	-1000	+1000
2	+99000	+101000
3	0	0
4	+199000	+201000
5	0	0
6	0	0
7	0	0
8	+299000	+301000
9	0	0
10	0	0
11	0	0
12	0	0
13	0	0
14	0	0
15	0	0
16	+399000	+401000
17	0	0
18	0	0
19	0	0
20	0	0
21	0	0
22	0	0
23	0	0
24	0	0
25	0	0
26	0	0
27	0	0
28	0	0
29	0	0
30	0	0
31	0	0

13.5 ZONE Outputs

13.5.4 ZONE Output Application Example

The relationship between the operation pattern, ZONE signals, and /POUT signal is shown in the following figure.

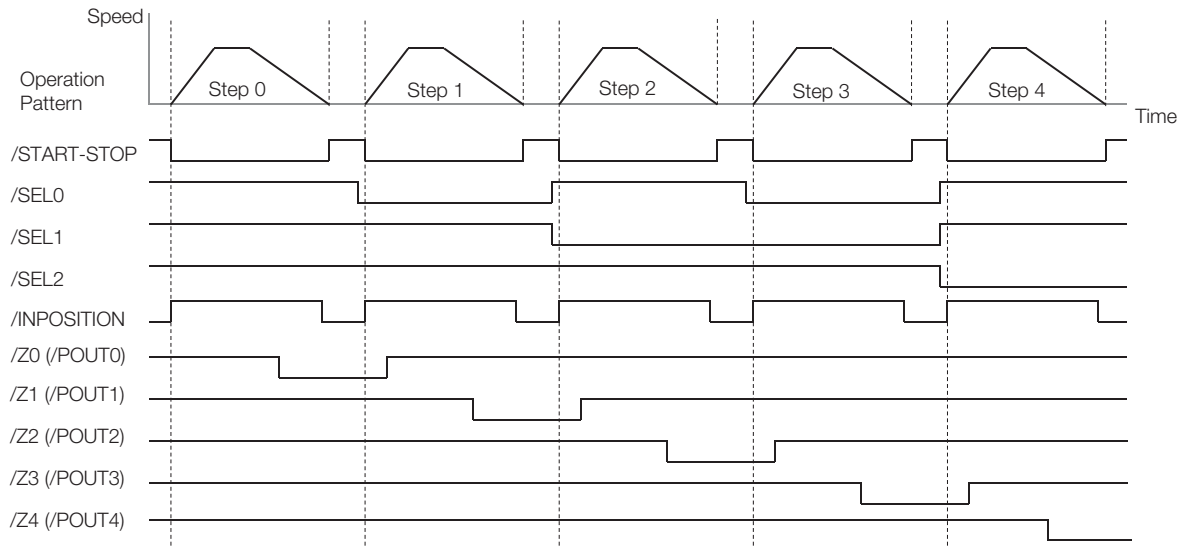

Using the ZONE Outputs as Passing Signals

In this example, the ZONE numbers are output at passing signals as the motor passed through the registered zones. You can use the passing signals as required, e.g., to trigger operations related to positioning.

Assume that the program table consists of the following two steps.

PGMSTEP	POS	SPD	RDST	RSPD	ACC	DEC	POUT	EVENT	LOOP	NEXT
0	A+500000	30000	-	1000	:	:	NNNZZZZZ	IT0	1	1
1	A+000000	30000	-	1000	:	:	NNNZZZZZ	IT0	1	0

The ZONE table is shown below.

ZONE Number (ID)	ZONE N	ZONE P
0	0	0
1	+99995	+100004
2	+199995	+200004
3	0	0
4	+299995	+300004
5	0	0
6	0	0
7	0	0
8	+399995	+400004
9	0	0
10	0	0
11	0	0
12	0	0
13	0	0
14	0	0
15	0	0
16	+499995	+500004
17	0	0
18	0	0
19	0	0
20	0	0
21	0	0
22	0	0
23	0	0
24	0	0
25	0	0
26	0	0
27	0	0
28	0	0
29	0	0
30	0	0
31	0	0

13.5 ZONE Outputs

13.5.4 ZONE Output Application Example

The relationship between the operation pattern and the ZONE numbers for this example is shown in the following figure.

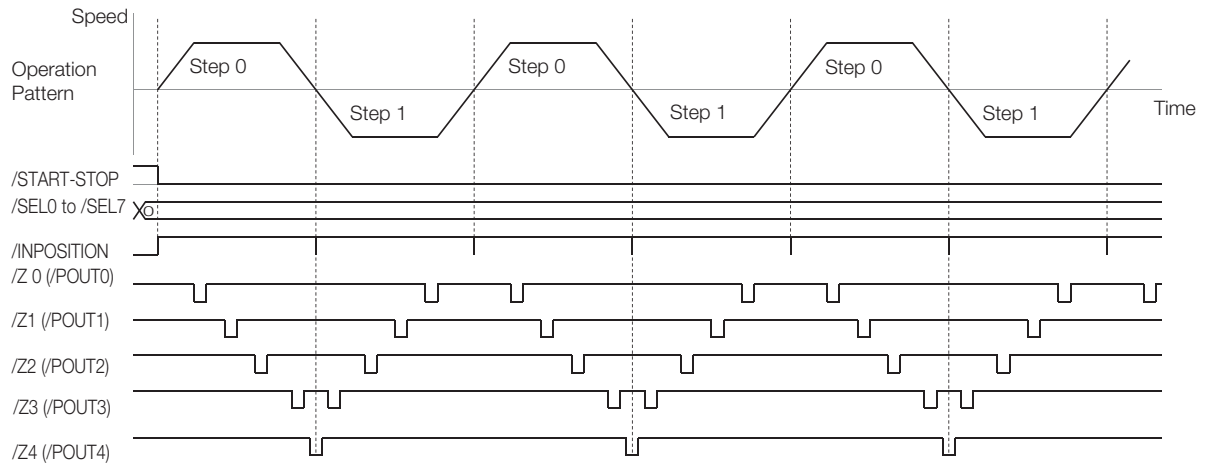

Operation with Serial Command Communications

14

This chapter provides information on using serial commands to operate the INDEXER Module.

14.1	Introduction to Serial Command Communications	.. 14-3
14.2	Communications Specifications for Serial Command Communications	.. 14-4
14.3	Settings	14-5
14.3.1	Simplified Configuration Diagram	14-5
14.3.2	Setting the Axis Address	14-5
14.3.3	Parameters Related to Serial Communications	.. 14-6
14.4	Command/Response Format	14-7
14.5	Global Commands	14-8
14.6	Echoback Response Time	14-9
14.7	Response Data Details	14-10
14.7.1	Positive Responses	14-10
14.7.2	Negative Responses	14-10

14.8 Serial Commands 14-11

14.8.1 Basic Operation Commands 14-11

14.8.2 Homing 14-12

14.8.3 Positioning, Jog Operation, and
Registration with Serial Commands 14-15

14.8.4 Positioning with a Program Table 14-24

14.8.5 Editing a Jog Speed Table 14-29

14.8.6 Editing a ZONE Table 14-29

14.8.7 Editing Parameters, Monitoring,
and Utility Functions 14-30

14.1 Introduction to Serial Command Communications

You can use serial command communications to perform the following functions.

- Homing
- Positioning, jog operation, and registration with serial commands
- Positioning with a program table
- Editing a jog speed table
- Editing a ZONE table
- Editing parameters, monitoring, and utility functions

14.2 Communications Specifications for Serial Command Communications

The communications specifications for serial command communications are given in the following table.

Item	Specifications
Interface	Full duplex (RS-422 or RS-485) or half duplex (RS-485) (Set the appropriate wiring method with parameter PnB00.)
Synchronization	Start-stop synchronization (ASYNC)
Bit Rate	9600, 19200, or 38400 bps (Selectable with parameter PnB01.)
Start Bits	1 bit
Data Bits	7 bits, ASCII code
Parity Bits	1 bit, even parity
Stop Bits	1 bit
X-ON/X-OFF Control	No
DTR/DSR Control	No
RTS/CTS Control	No
Echoback	Each character, Each command, or None Select the specification with the PnB00 parameter.

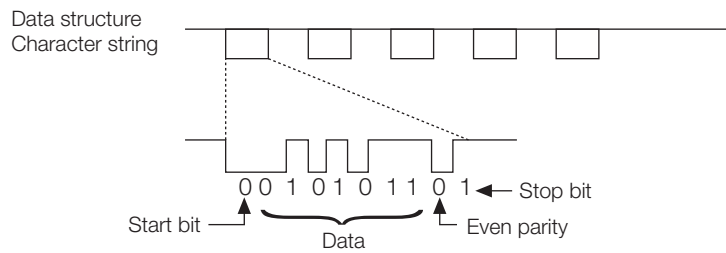

14.3 Settings

This section explains the settings for the INDEXER Module's serial commands.

14.3.1 Simplified Configuration Diagram

The following diagram shows the basic connections for multi-axis control.

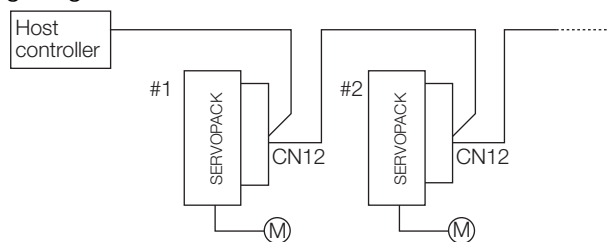

Up to 16 axes can be connected.

Refer to the following section for information on wiring.

4.6 Serial Command Communications Connector (CN12) on page 4-45

14.3.2 Setting the Axis Address

Axis addresses can be set with parameter Pn010 (axis address selection). Set an axis address in the range 1 to F. If an address outside this range is set, serial command communications will not be performed. Refer to the following section for information on the parameter setting methods.

5.1 Manipulating Parameters (Pn□□□) on page 5-3

Note: With the INDEXER Module (NS600) for SGD_H SERVOPACKs, axis addresses were set with rotary switches, but with INDEXER Modules (SGDV-OCA03A) for SGD_V SERVOPACKs, axis addresses are set in the parameters.

14.3.3 Parameters Related to Serial Communications

The following table shows the parameters that set the communications protocol, bit rate, and “OK” response.

Parameter	Meaning	When Enabled	
PnB00	0	Full-duplex wiring is used for communications method.	After restart
	1 (default setting)	Full-duplex wiring is used for communications method. Echoback is performed for each character.	
	2	Half-duplex wiring is used for communications method. CR is used as the delimiter.	
	3	Half-duplex wiring is used for communications method. CR is used as the delimiter. Echoback is performed for each character.	
	4	Half-duplex wiring is used for communications method. CR is used as the delimiter. Echoback is performed for each command.	
	5	Half-duplex wiring is used for communications method. CRLF is used as the delimiter.	
	6	Half-duplex wiring is used for communications method. CRLF is used as the delimiter. Echoback is performed for each character.	
	7	Half-duplex wiring is used for communications method. CRLF is used as the delimiter. Echoback is performed for each command.	
	8, 9	Reserved parameter	
PnB01	0 (default setting)	Sets bit rate at 9600 bps.	After restart
	1	Sets bit rate at 19200 bps.	
	2	Sets bit rate at 38400 bps.	
PnB02	0	Does not return OK response.	Immediately
	1 (default setting)	Returns OK response.	

14.4 Command/Response Format

The following diagram shows the command/response format.

Command (Host controller → INDEXER Module)			Response (Host controller ← INDEXER Module)		
Axis no.	Command character string	Delimiter	Axis no.	Response character string	Delimiter
Example:					
1	SVON	[CR]	1	OK	[CR] [LF]
2	SVON	[CR]	2	OK	[CR] [LF]
1	POS10000	[CR]	1	OK	[CR] [LF]
2	POS10000	[CR]	2	OK	[CR] [LF]
1	ST	[CR]	1	OK	[CR] [LF]
2	ST	[CR]	2	OK	[CR] [LF]
1	PUN	[CR]	1	PUN = +00004567	[CR] [LF]
2	PUN	[CR]	2	PUN = -00002345	[CR] [LF]
<p>Note: When full-duplex wiring is being used, either [CR] or [CR] [LF] can be used as the delimiter. When half-duplex wiring is being used, set the delimiter to either [CR] or [CR] [LF] with parameter PnB00. In both cases, [CR] [LF] will be returned as the echoback. Upper-case and lower-case characters can be used in the command (including the axis number) and are treated the same.</p>			<p>Note: The response's delimiter is always [CR] [LF]. Alphabetical characters in the response are always upper-case.</p>		

Note: In ASCII, the [CR] character is 0Dh and the [LF] character is 0Ah.



To maximize communications reliability, confirm the echoback and responses to each command while communicating with the INDEXER Module. When the echoback and responses are not being confirmed, improve the communications reliability by reading the status when appropriate.

14.5 Global Commands

Global commands are commands that are sent to all axes at the same time.

Command (Host controller → INDEXER Module)			Response (Host controller ← INDEXER Module)
“*”	Command character string	Delimiter	No response returned.
Example: *SVON [CR] *ST [CR] *PUN [CR]			
The axis number setting “*” is the global address and addresses all axes. No echoback or response is returned when the global address is used.			



Important

When global commands are used, improve the communications reliability by reading the status when appropriate.

14.6 Echoback Response Time

The following diagram shows the response time from the command transmission until the echoback.

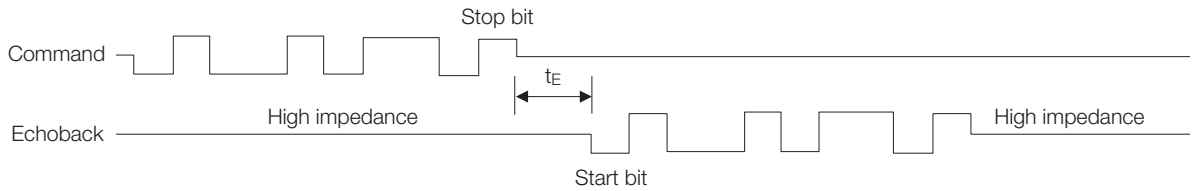

PnB00 (Protocol) Settings	t_E Min.	t_E Max.
1: Full-duplex wiring is used for communications method. Echoback is performed for each character.	$-\frac{1}{\text{Bit rate} \times 2}$ (Centered at the command stop bit)	$100 \mu\text{s} + \frac{1}{\text{Bit rate} \times 2}$
3: Half-duplex wiring is used for communications method. CR is used as the delimiter. Echoback is performed for each character.	$250 \mu\text{s} - \frac{1}{\text{Bit rate} \times 2}$	$600 \mu\text{s} + \frac{1}{\text{Bit rate} \times 2}$
4: Half-duplex wiring is used for communications method. CR is used as the delimiter. Echoback is performed for each command.		
6: Half-duplex wiring is used for communications method. CRLF is used as the delimiter. Echoback is performed for each character.	$250 \mu\text{s} - \frac{1}{\text{Bit rate} \times 2}$	$600 \mu\text{s} + \frac{1}{\text{Bit rate} \times 2}$
7: Half-duplex wiring is used for communications method. CRLF is used as the delimiter. Echoback is performed for each command.		

Example For PnB00 = 1 and PnB01 = 0 (bit rate of 9,600 bps):

$$t_E \text{ min} = -\frac{1}{\text{Bit rate} \times 2} = -\frac{1}{9600 \times 2} = -52 \mu\text{s}$$



When using half-duplex wiring, the host controller must set the line driver to high impedance within the t_E min. response time.

14.7 Response Data Details

There are positive responses and negative responses.

The positive response indicates normal operation and the negative response indicates an error.

14.7.1 Positive Responses

There are two kinds of positive responses, responses that return data (for commands such as PRM) and responses that do not return data (for commands such as SVON).

For commands that require data to be returned, refer to the description of the individual command for details on the structure of the response's character string.

For commands that do not require data to be returned, the positive response is "OK" unless parameter PnB02 is set to 0. If PnB02 = 0, there is no response.

◆ Structure of the Response "OK"

OK [SP] [SP] [SP] [SP] [SP] [SP] [SP] [SP] [SP] [CR] [LF]

Note: In ASCII, the [SP] character is 20h, the [CR] character is 0Dh, and the [LF] character is 0Ah.

14.7.2 Negative Responses

There will be no response if one of the following errors is detected: a parity error (E48E), framing error (E49E), or overrun error (E4AE). There will be no response to a global command or a command with an incorrect axis number.

In all other cases, a negative response will be returned if an error is detected.

◆ Structure of the Negative Response

Undefined Command Error	E56E [SP] ERR [SP] SN [CR] [LF]
Address Out-of-range Error	E57E [SP] ERR [SP] PN [CR] [LF]
Data Out-of-range Error	E58E [SP] ERR [SP] OV [CR] [LF]
Other Errors	ExxE [SP] [SP] [SP] [SP] [SP] [SP] [SP] [CR] [LF] The xx is the error number.

Note: In ASCII, the [SP] character is 20h, the [CR] character is 0Dh, and the [LF] character is 0Ah.

14.8 Serial Commands

The axis number and delimiter are attached to actual serial commands, but are omitted here. Some data in responses (such as parameters, table numbers, and monitored data) is expressed numerically. The presence/absence of the sign and the number of digits are correct in the numerical data shown in these examples, but the sign and numerical value will vary in actual applications.

14.8.1 Basic Operation Commands

The following table shows the basic operation commands.

Serial Command	Function/Description	Positive Response (Normal Response)
SVON	Servo ON: Supplies power to the Servomotor. This command is the same as turning ON the /S-ON signal.	OK
SVOFF	Servo OFF: Stops the power supply to the Servomotor. This command is the same as turning OFF the /S-ON signal.	OK
ARES	Alarm Reset: Clears the alarm.	The response "OK" will be returned when the alarm has been cleared. The alarm code will be returned if the alarm remains uncleared. ALM [SP] A. xxx [SP] [CR] [LF] (The xxx is the SERVOPACK alarm code.) ALM [SP] E xxA [SP] [CR] [LF] (The xx is the INDEXER Module alarm code.)
RES	Reset: This command is the same as turning OFF/ON the control power supply.	None (No response) Note: If the RES command has been successfully executed, no response will be returned. Because the execution of the RES command resets all status in the same way that restarting the control power supply will, serial communications will be unstable for a maximum of 5 seconds after the RES command is used. Wait at least 5 seconds before sending the next command.

14.8.2 Homing

The following commands are used for homing.

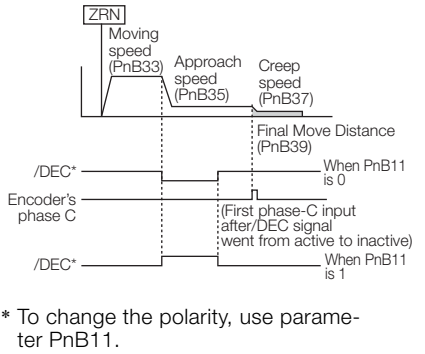
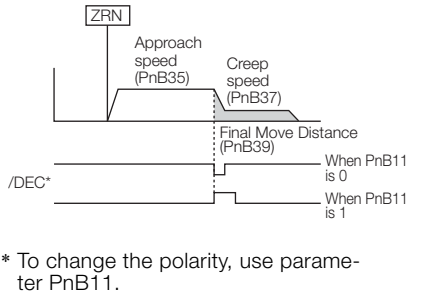
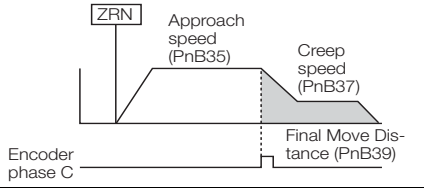
Serial Command	Function/Description		Positive Response	
ZRN	Homing Starts homing. When homing has been stopped with the HOLD command, homing will be restarted (the hold will be cleared) when the ZRN command is executed again. The parameters for homing are specified in parameters PnB31 to PnB39.		OK	
	PnB31 Homing Method	PnB32 Homing Direction		PnB33 to PnB39
	PnB31 = 0: No homing. Homing ends when the control power supply is turned ON.	-		-
	PnB31 = 1: Uses the /DEC signal and the encoder's phase C.			 <p>* To change the polarity, use parameter PnB11.</p>
PnB31 = 2: Uses the /DEC signal only.	PnB32 = 0: Forward PnB32 = 1: Reverse		 <p>* To change the polarity, use parameter PnB11.</p>	
PnB31 = 3: Uses the encoder's phase C only.				
The current position when homing is completed is specified in PnB25. When the control power supply is turned ON and homing is completed, the value of the current position is replaced with the value in PnB25.				

Continued on next page.

Continued from previous page.

Serial Command	Function/Description				Positive Response	
ZRN	PnB25	<ul style="list-style-type: none"> When using an incremental encoder: Origin When using an absolute encoder: Absolute Encoder Offset 				OK
		Setting Range	Setting Unit	Default Setting	When Enabled	
		-99999999 to +99999999*	1 reference unit	0	After restart	
	Parameter		Meaning		When Enabled	
	PnB31	0 (default setting)	Homing is not executed.		After restart	
		1	/DEC and phase C are used for homing.			
		2	Only /DEC is used for homing.			
		3	Only phase C is used for homing.			
	PnB32	0 (default setting)	/HOME or ZRN command is used for homing in forward direction.		Immediately	
		1	/HOME or ZRN command is used for homing in reverse direction.			
	PnB33	Homing Moving Speed				
		Setting Range	Setting Unit	Default Setting	When Enabled	
		1 to 99999999*	1000 Reference units/min	1000	Immediately	
	PnB35	Homing Approach Speed				
		Setting Range	Setting Unit	Default Setting	When Enabled	
		1 to 99999999*	1000 Reference units/min	1000	Immediately	
	PnB37	Homing Creep Speed				
		Setting Range	Setting Unit	Default Setting	When Enabled	
		1 to 99999999*	1000 Reference units/min	1000	Immediately	
	PnB39	Homing Final Move Distance				
Setting Range		Setting Unit	Default Setting	When Enabled		
-99999999 to +99999999*		1 reference unit	0	Immediately		
<p>Note: 1. The software limits (PnB21 and PnB23) are disabled until homing is completed. They are enabled after homing is completed. On the other hand, the overtravel signals (P-OT and N-OT signals) are enabled before homing is completed.</p> <p>2. When an incremental encoder is being used, homing will be completed if the ZSET command (coordinates setting) is executed instead of homing.</p> <p>3. Error E5DE will occur if the ZRN command is executed while PnB31 = 0.</p> <p>4. Homing can be performed only when an incremental encoder is being used. Error E61E will occur if the ZRN command is executed and an absolute encoder is being used.</p>						

Continued on next page.

Continued from previous page.

Serial Command	Function/Description	Positive Response
ZSET (±) nnnnnnn*	<p>Coordinates Setting</p> <p>Note: It can be dangerous to execute this command carelessly to switch the coordinates of the reference position. After executing this command, confirm that the reference position and the new coordinates are in agreement before starting operation.</p> <p>Setting range: -99999999 ≤ nnnnnnn ≤ +99999999 [Reference units]</p> <ul style="list-style-type: none"> • With an Incremental Encoder Replaces the current position with nnnnnnn. Homing will be completed and the software limits (PnB21 and PnB23) will be enabled. This coordinates setting will be cleared when the control power supply is turned OFF. <p>Note: Parameter PnB25 will not be refreshed. PnB25 will be used as the current position when the control power supply is turned ON and homing is completed.</p> <ul style="list-style-type: none"> • With an Absolute Encoder Switches the current position to nnnnnnn and refreshes PnB25 with the absolute position offset so that the current position becomes nnnnnnn. The coordinates setting will remain effective after the control power supply is turned OFF. Normally, this command is executed once during system setup and it is not necessary to execute it again. Each time that the command is executed, the content of PnB25 is refreshed and stored in EEPROM, so this command must not be executed repeatedly or too frequently. <p>Note: When one of the Pn20E to Pn210, Pn205, or PnB20 to PnB25 parameters has been changed, enable the new setting by turning the control power supply OFF and then ON again before executing the command.</p>	OK

* If you set PnB54 to 1 (Enable Expansion Mode), the parameter setting range, the command name, and the command setting range will change. Refer to the following section for details.

 12.4 Speed/Position Expansion Function Setting on page 12-8

14.8.3 Positioning, Jog Operation, and Registration with Serial Commands

The following commands are used for positioning, jog operation, and registration with serial commands.

Serial Command	Function/Description	Positive Response
<p>POS (±) nnnnnnnn* POSA (±) nnnnnnnn* (The + sign can be omitted.)</p>	<p>Target Position Specification (Absolute Position)</p> <p>Setting range: $-99999999 \leq \text{nnnnnnnn} \leq +99999999$ [1 reference unit] Specifies the target position as an absolute position.</p> <p>Note: If a new target position is specified during positioning, the new target position will be used in the next ST command.</p>	<p>OK</p>
<p>POSI (±) nnnnnnnn* (The + sign can be omitted.)</p>	<p>Target Position Specification (Relative Distance)</p> <p>Setting range: $-99999999 \leq \text{nnnnnnnn} \leq +99999999$ [1 reference unit] Specifies the target position as a relative distance.</p> <p>Note: If a new target position is specified during positioning, the new target position will be used in the next ST command.</p>	<p>OK</p>
<p>SPDnnnnnnnn*</p>	<p>Positioning Speed Specification</p> <p>Setting range: $1 \leq \text{nnnnnnnn} \leq +99999999$ [1000 reference units/min] Specifies the positioning speed. After the control power supply is turned ON, the positioning speed set in parameter PnB27 will be used until the SPD command is executed.</p> <p>For example, when the reference unit is 0.01 mm and the desired speed is 15 m/min: $15 \text{ m/min} = 15000 \text{ mm/min}$ $= 15000 \times 100 \text{ reference unit/min}$ $= 1500 \text{ [1000 reference unit/min]}$ SPD1500</p> <p>Note: If a new positioning speed is specified during positioning, the new speed will become effective from the next positioning.</p>	<p>OK</p>

Continued on next page.

Continued from previous page.

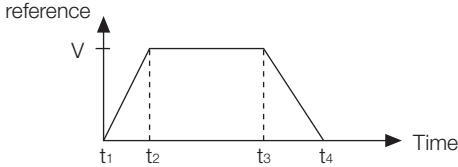
Serial Command	Function/Description	Positive Response
ACCnnnnnnnn*	<p>Acceleration Specification</p> <p>Setting range: $1 \leq \text{nnnnnnnn} \leq +99999999$ [1000 (reference units/min)/ms]</p>  $\text{Acceleration} = \frac{V [\times 1000 \text{ reference units/min}]}{t_2 - t_1 [\text{ms}]}$ $\text{Deceleration} = \frac{V [\times 1000 \text{ reference units/min}]}{t_4 - t_3 [\text{ms}]}$ <p>Note: The acceleration setting in parameter PnB29 can also be used. Executing the command ACCnnnnnnnn is the same as executing TRMB29 = nnnnnnnn.</p>	OK
DECnnnnnnnn*	<p>Deceleration Specification</p> <p>Setting range: $1 \leq \text{nnnnnnnn} \leq +99999999$ [1000 (reference units/min)/ms]</p> <p>Note: The deceleration setting in parameter PnB2B can also be used. Executing the command DECnnnnnnnn is the same as executing TRMB2B = nnnnnnnn.</p>	OK
ST	<p>Positioning Start</p> <p>Starts positioning with the speed specified by the SPD command and the target position specified by the POS, POSA, or POSI command. The target position specification and speed specification can be omitted. In this case, the previous positioning will be repeated. Error E51E will occur if the ST command is executed but the target position hasn't been specified even once. If the ST command is executed but the speed hasn't been specified even once, the speed specified in parameter PnB27 will be used. When positioning has been stopped with the HOLD command, the positioning will be restarted (the hold will be cleared) if the ST command is executed.</p> <p>Example 1: POSI + nnnnnnnn: Target Position Specification SPDnnnnnnnn: Positioning Speed Specification ST: Positioning Start ST: Repeat</p> <p>Example 2: POSI + nnnnnnnn: Target Position Specification ST: Positioning Start (using the speed specified in PnB27)</p> <p>Example 3: POSI + nnnnnnnn: Target Position Specification ST: Positioning Start HOLD: Positioning Interruption ST: Positioning Restart (Clear Hold)</p> <p>Note: An E53E error will occur if a new move command such as the ST command is received while the motor is already moving (positioning or other moving operation). Execute a move command such as the ST command only after the previous moving operation has been completed.</p>	OK

Continued on next page.

Continued from previous page.

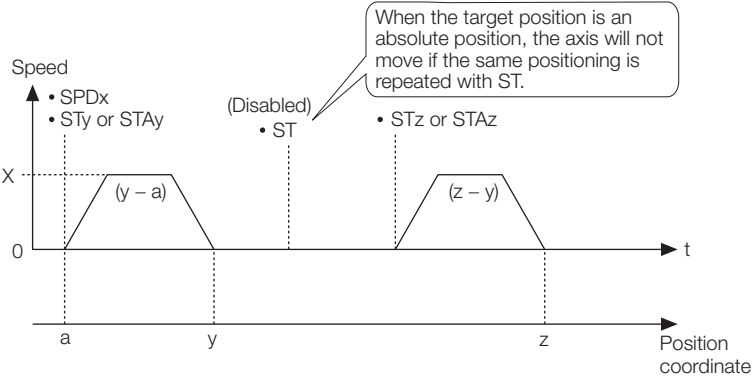
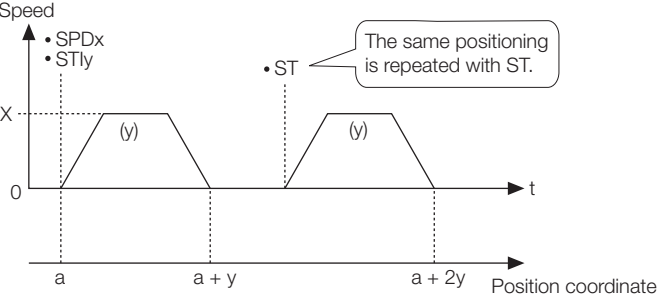
Serial Command	Function/Description	Positive Response
<p>ST (±) nnnnnnnn* STA (±) nnnnnnnn* (The + sign can be omitted.)</p>	<p>Positioning Start (Absolute Position)</p> <p>Setting range: $-99999999 \leq \text{nnnnnnnn} \leq +99999999$ [1 reference unit]</p> <p>Specifies the absolute position nnnnnnnn as the target position and starts positioning at the same time. This command is equivalent to the following combination: POSA + nnnnnnnn → ST</p> <p>Example: SPDnnnnnnn: Positioning Speed Specification STA + nnnnnnnn: Target Position Specification and Positioning Start</p> 	<p>OK</p>
<p>STI (±) nnnnnnnn* (The + sign can be omitted.)</p>	<p>Positioning Start (Relative Position)</p> <p>Setting range: $-99999999 \leq \text{nnnnnnnn} \leq +99999999$ [1 reference unit]</p> <p>Specifies the relative distance nnnnnnnn as the target position and starts positioning at the same time. This command is equivalent to the following combination: POSI + nnnnnnnn → ST</p> <p>Example: SPDnnnnnnn: Positioning Speed Specification STI + nnnnnnnn: Target Position Specification and Positioning Start</p> 	<p>OK</p>

Continued on next page.

Continued from previous page.

Serial Command	Function/Description	Positive Response
RDSTnnnnnnn*	<p>Registration Distance Specification</p> <p>Setting range: $0 \leq \text{nnnnnnnn} \leq 99999999$ [1 reference unit]</p> <p>Specifies the registration distance that is used in the RS, RSnnnnnnnn, RSAnnnnnnnn, and RSlnnnnnnnn commands.</p> <div data-bbox="715 510 1082 734" style="text-align: center;"> </div> <p>Note: Alarm E23A will occur (the Servomotor will become servo OFF state) if the /RGRT signal is latched but the deceleration distance is longer than the registration distance (if the registration distance would be exceeded even if deceleration were started immediately).</p>	OK
RSPDnnnnnnnn*	<p>Registration Speed Specification</p> <p>Setting range: $1 \leq \text{nnnnnnnn} \leq 99999999$ [1000 reference units/min]</p> <p>Specifies the registration speed.</p> <p>After the control power supply is turned ON, the registration speed set in parameter PnB27 will be used until the speed is specified with this command.</p> <p>Note: If a new registration speed is specified during registration operation, the new speed will become effective from the next registration operation.</p>	OK

Continued on next page.

Continued from previous page.

Serial Command	Function/Description	Positive Response
RS	<p>Positioning Start with Registration</p> <p>Starts positioning with the speed specified by the SPD command and the target position specified by the POS, POSA, or POSI command. If the /RGRT signal goes ON during positioning, that position is latched and the motor will move the specified relative distance from the latched position. The registration operation uses the registration distance specified by the RDST command and the registration speed specified by the RSPD command. The target position specification, positioning speed specification, registration distance specification, and registration speed specification can be omitted. In this case, the positioning performed in the previous registration operation will be repeated.</p> <p>Error E51E will occur if the RS command is executed but the target position hasn't been specified even once. Error E52E will occur if the RS command is executed but the registration distance hasn't been specified even once. If the RS command is executed but the positioning speed and registration speed haven't been specified even once, the speed specified in parameter PnB27 will be used either as the positioning speed or the registration speed.</p> <p>When registration positioning has been stopped with the HOLD command, the registration positioning will be restarted (the hold will be cleared) if the RS command is executed.</p> <p>Example 1: POSI + nnnnnnnn: Target Position Specification SPDnnnnnnnn: Positioning Speed Specification RDSTnnnnnnnn: Registration Distance Specification RSPDnnnnnnnn: Registration Speed Specification RS: Positioning Start with Registration RS: Repeat</p> <p>Example 2: POSI + nnnnnnnn: Target Position Specification RDSTnnnnnnnn: Registration Distance Specification RS: Positioning Start with Registration (using the speed specified in PnB27 for both the positioning and registration speeds)</p> <p>Example 3: POSI + nnnnnnnn: Target Position Specification RDSTnnnnnnnn: Registration Distance Specification RS: Positioning Start with Registration HOLD: Positioning Interruption RS: Positioning Restart (Clear Hold)</p> <p>Note: Error E53E will occur if a new move command such as the RS command is received while the motor is already moving (positioning or other moving operation). Execute a move command such as the RS command only after the previous moving operation has been completed.</p>	OK
RS (±) nnnnnnnn* RSA (±) nnnnnnnn* (The + sign can be omitted.)	<p>Positioning Start with Registration (Absolute Position)</p> <p>Setting range: -99999999 ≤ nnnnnnnn ≤ +99999999 [1 reference unit]</p> <p>Specifies the absolute position nnnnnnnn as the target position and starts registration positioning at the same time. This command is equivalent to the following combination: POSA + nnnnnnnn → RS</p> <p>Example: SPDnnnnnnnn: Positioning Speed Specification RDSTnnnnnnnn: Registration Distance Specification RSPDnnnnnnnn: Registration Speed Specification RSA +nnnnnnnn: Target Position Specification and Positioning Start with Registration</p>	OK

Continued on next page.

Continued from previous page.

Serial Command	Function/Description	Positive Response
<p>RSI (\pm) nnnnnnnn* (The + sign can be omitted.)</p>	<p>Positioning Start with Registration (Relative Distance)</p> <p>Setting range: $-99999999 \leq \text{nnnnnnnn} \leq +99999999$ [1 reference unit]</p> <p>Specifies the relative distance nnnnnnnn as the target position and starts registration positioning at the same time. This command is equivalent to the following combination: POSI + nnnnnnnn \rightarrow RS</p> <p>Example: SPDnnnnnnnn: Positioning Speed Specification RDSTnnnnnnnn: Registration Distance RSPDnnnnnnnn: Registration Speed Specification RSI +nnnnnnnn: Target Position Specification and Positioning Start with Registration</p>	<p>OK</p>
<p>JOGPnnnnnnnn* JOGNnnnnnnnn*</p>	<p>JOG Forward/Reverse</p> <p>Setting range: $1 \leq \text{nnnnnnnn} \leq 99999999$ [1000 reference units/min]</p> <p>Starts JOG forward or JOG reverse operation at the speed specified in nnnnnnnn.</p> <p>JOGPnnnnnnnn: Forward JOGNnnnnnnnn: Reverse</p> <p>The specified speed and JOG direction can be changed while jog operation is in progress.</p>	<p>OK</p>

Continued on next page.

Continued from previous page.

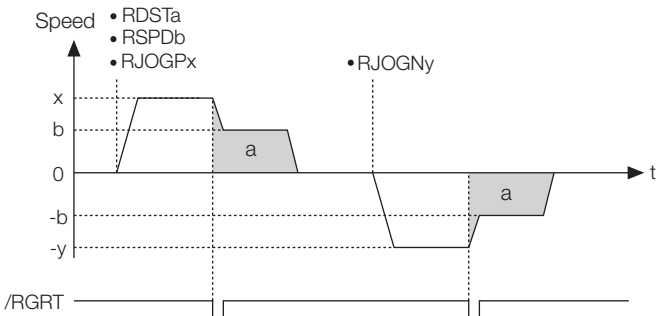
Serial Command	Function/Description	Positive Response
<p>RJOGPnnnnnnnn*</p> <p>RJOGNnnnnnnnn*</p>	<p>JOG Forward/Reverse with Registration</p> <p>Setting range: $1 \leq \text{nnnnnnnn} \leq 99999999$ [1000 reference units/min]</p> <p>Starts JOG forward or JOG reverse operation at the speed specified in nnnnnnnn.</p> <p>RJOGPnnnnnnnn:Forward RJOGNnnnnnnnn:Reverse</p> <p>If the /RGRT signal goes ON during forward/reverse jog operation, that position is latched and the motor will move the specified relative distance from the latched position. The registration operation uses the registration distance specified by the RDST command and the registration speed specified by the RSPD command.</p> <p>Error E52E will occur if the RJOGP/RJOGNnnnnnnnn command is executed but the registration distance hasn't been specified even once. If the RJOGP/RJOGNnnnnnnnn command is executed but the registration speed hasn't been specified even once, the speed specified in parameter PnB27 will be used for the registration speed.</p> <p>When registration jog operation has been stopped with the HOLD command, forward registration jog operation will be restarted (the hold will be cleared) when the RJOGPnnnnnnnn command is executed again. Reverse registration jog operation will be restarted when the RJOGNnnnnnnnn command is executed again.</p> <p>The specified speed and direction cannot be changed while jog operation is in progress. Error E53E will occur if the speed or direction is changed during operation.</p> 	<p>OK</p>

Continued on next page.

Continued from previous page.

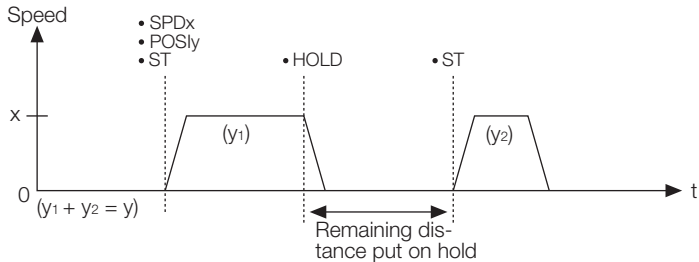
Serial Command	Function/Description	Positive Response
HOLD	<p>Positioning Interruption</p> <p>Interrupts the current positioning. The remainder of the positioning is put on hold.</p> <p>When the HOLD command has interrupted a positioning initiated by an ST, STnnnnnnnn, STAnnnnnnnn, or STInnnnnnnn command, the positioning can be restarted by executing the ST command.</p> <p>When the HOLD command has interrupted registration positioning initiated by an RS, RSnnnnnnnn, RSAnnnnnnnn, or RSInnnnnnnn command, the registration positioning can be restarted by executing the RS command.</p> <p>When the HOLD command has interrupted a “forward jog operation with registration” operation that was initiated by the RJOGPnnnnnnnn command, the operation can be restarted by executing the RJOGPnnnnnnnn command again.</p> <p>When the HOLD command has interrupted a “reverse jog operation with registration” operation that was initiated by the RJOGNnnnnnnnn command, the operation can be restarted by executing the RJOGNnnnnnnnn command again.</p> <p>When the HOLD command has interrupted homing initiated by the ZRN command, homing can be restarted by executing the ZRN command.</p> <p>When the HOLD command is executed during a JOG forward operation initiated by JOGPnnnnnnnn or a JOG reverse operation initiated by JOGNnnnnnnnn, the JOG operation will be stopped.</p> 	OK

Continued on next page.

Continued from previous page.

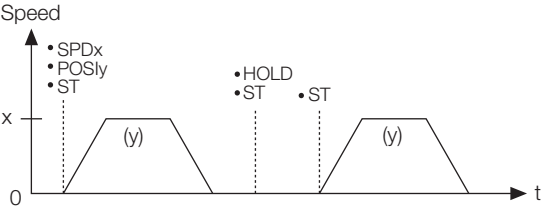
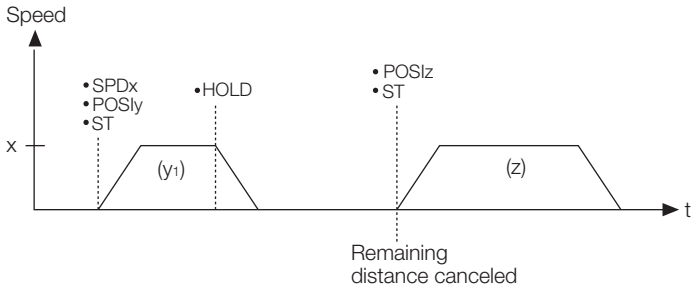
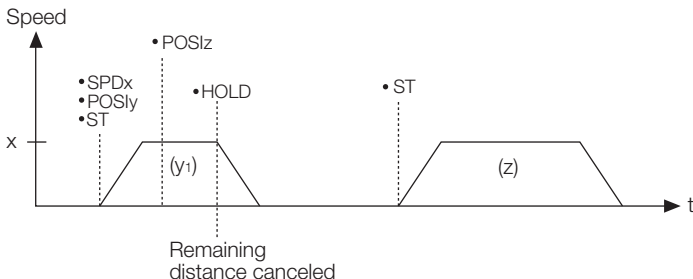
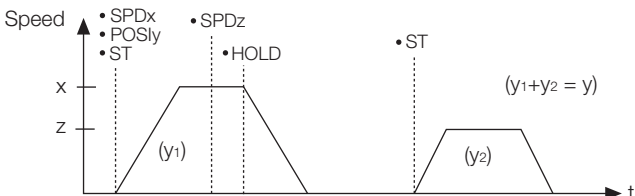
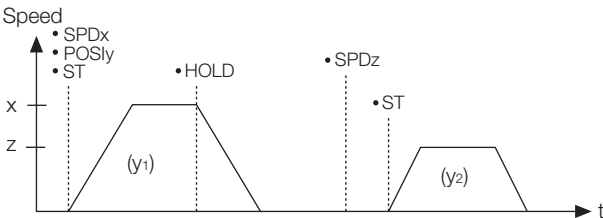
Serial Command	Function/Description	Positive Response
HOLD	<p>When the HOLD command is executed after positioning is completed, a remaining distance of zero is put on hold.</p> 	
	<p>If a new target position is specified while a positioning has been put on hold by the HOLD command, the remaining distance is canceled and the new target position is used instead.</p>  <p style="text-align: center;">Remaining distance canceled</p>	
	<p>Even if a new target position is specified before the HOLD command is executed, the remaining distance will be canceled and the new target position will be used instead.</p>  <p style="text-align: center;">Remaining distance canceled</p>	OK
	<p>When the speed setting has been changed, the new setting will be used when positioning is restarted.</p> <p>Example 1:</p> 	
	<p>Example 2:</p> 	

Continued on next page.

Continued from previous page.

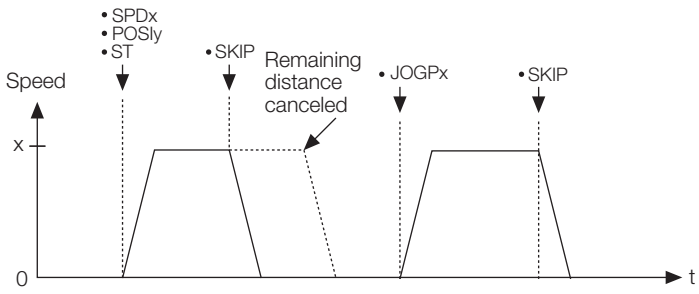
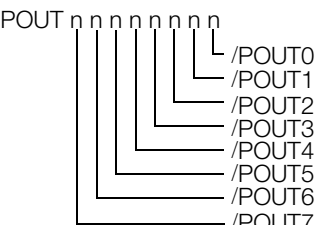
Serial Command	Function/Description	Positive Response
SKIP	<p>Positioning Stop</p> <p>Stops the current positioning. The remaining distance will be canceled.</p> 	OK
POUTnnnnnnnn	<p>POUT Specification</p> <p>Specifies the operation of programmable output signals /POUT0 to /POUT7.</p> <p>Settings: N: Inactive A: Active Z: ZONE table “.”: Continue</p> 	OK

* If you set PnB54 to 1 (Enable Expansion Mode), the command name and the command setting range will change. Refer to the following section for details.
 12.4 Speed/Position Expansion Function Setting on page 12-8

14.8.4 Positioning with a Program Table

Program Table Setup Commands

The following table shows the Program Table Setup Commands.

Serial Command	Function/Description	Positive Response
PGMSTORE	<p>Program Table Save</p> <p>Saves the program table in flash memory. Once PGMSTORE is executed, the program table will be retained after the control power supply is turned OFF. Because the program table is stored in flash memory, this command must not be executed frequently.</p> <p>Note: Do not turn OFF the control power supply while PGMSTORE is being executed. Execution can take a few seconds to slightly longer than 10 seconds. The green LED will flash during execution.</p>	OK

Continued on next page.

Continued from previous page.

Serial Command	Function/Description	Positive Response
PGMINIT	<p>Program Table Initialization</p> <p>Resets all values in the program table to their default settings.</p> <p>Note: Do not turn OFF the control power supply while PGMINIT is being executed. Execution can take a few seconds to slightly longer than 10 seconds. The green LED will flash during execution.</p>	OK
POSTsss*	<p>Program Table POS Read</p> <p>Reads the POS value (positioning target position). sss: Program step (PGMSTEP)</p>	POST123 = A+12345678 [CR] [LF] POST123 = I+12345678 [CR] [LF] POST123 = S+12345678 [CR] [LF] POST123 = +INFINITE [SP] [CR] [LF] POST123 = STOP [SP] [SP] [SP] [SP] [SP] [SP] [CR] [LF] POST123 = -[SP] [SP] [SP] [SP] [SP] [SP] [SP] [SP] [SP] [CR] [LF]
POSTsss = nnnnnnnn*	<p>Program Table POS Write</p> <p>Sets the POS value (positioning target position). sss: Program step (PGMSTEP)</p> <p>Settings: Annnnnnnn: Absolute position [1 reference unit] (-99999999 ≤ nnnnnnnn ≤ +99999999) Innnnnnnn: Relative distance [1 reference unit] (-99999999 ≤ nnnnnnnn ≤ +99999999) Snnnnnnnn: Continuous stop [1 reference unit] (-99999999 ≤ nnnnnnnn ≤ +99999999) +INFINITE or -INFINITE: JOG forward or JOG reverse STOP: Stop -: No specification</p>	OK
SPDTsss*	<p>Program Table SPD Read</p> <p>Reads the SPD value (positioning speed). sss: Program step (PGMSTEP)</p>	SPDT123 = 12345678 [CR] [LF]
SPDTsss = nnnnnnnn*	<p>Program Table SPD Write</p> <p>Sets the SPD value (positioning speed). sss: Program step (PGMSTEP)</p> <p>Settings: 1 ≤ nnnnnnnn ≤ +99999999 [1000 reference units/min]</p>	OK
RDSTTsss*	<p>Program Table RDST Read</p> <p>Reads the RDST value (registration distance). sss: Program step (PGMSTEP)</p>	RDSTT123 = 12345678 [CR] [LF] RDSTT123 = -[SP] [SP] [SP] [SP] [SP] [SP] [SP] [CR] [LF]
RDSTTsss = nnnnnnnn*	<p>Program Table RDST Write</p> <p>Sets the RDST value (registration distance). sss: Program step (PGMSTEP)</p> <p>Settings: 0 ≤ nnnnnnnn ≤ 99999999: Registration distance [1 reference unit] -: No registration</p>	OK
RSPDTsss*	<p>Program Table RSPD Read</p> <p>Reads the RSPD value (registration speed). sss: Program step (PGMSTEP)</p>	RSPDT123 = 12345678 [CR] [LF]

Continued on next page.

Continued from previous page.

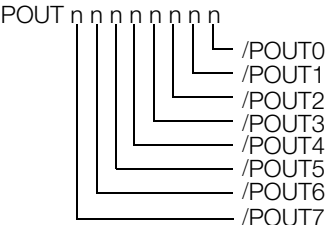
Serial Command	Function/Description	Positive Response
RSPDTsss = nnnnnnnn*	Program Table RSPD Write Sets the RSPD value (registration speed). sss: Program step (PGMSTEP) Settings: 1 ≤ nnnnnnnn ≤ +99999999 [1000 reference units/min]	OK
ACCTsss*	Program Table ACC Read Reads the ACC value (acceleration). sss: Program step (PGMSTEP)	ACCT123 = 12345678 [CR] [LF] ACCT123 = :[SP] [SP] [SP] [SP] [SP] [SP] [SP] [CR] [LF]
ACCTsss = nnnnnnnn*	Program Table ACC Write Sets the ACC value (acceleration). sss: Program step (PGMSTEP) Settings: 1 ≤ nnnnnnnn ≤ +99999999: Acceleration [1000 (reference units/min)/ms] “.”: Continues the previously executed program step’s specification.	OK
DECTsss*	Program Table DEC Read Reads the DEC value (deceleration). sss: Program step (PGMSTEP)	DECT123 = 12345678 [CR] [LF] DECT123 = :[SP] [SP] [SP] [SP] [SP] [SP] [SP] [CR] [LF]
DECTsss = nnnnnnnn*	Program Table DEC Write Sets the DEC value (deceleration). sss: Program step (PGMSTEP) Settings: 1 ≤ nnnnnnnn ≤ +99999999: Deceleration [1000 (reference units/min)/ms] “.”: Continues the previously executed program step’s specification.	OK
POUTTsss*	Program Table POUT Read Reads the POUT value (programmable output signal). sss: Program step (PGMSTEP)	POUTT123 = NANANANZ [CR] [LF]
POUTTsss = nnnnnnnn*	Program Table POUT Write Sets the POUT value (programmable output signal). sss: Program step (PGMSTEP) Settings: N: Not active A: Active Z: ZONE table “.”: Continues the previously executed program step’s specification. POUT n n n n n n n n 	OK

Continued on next page.

Continued from previous page.

Serial Command	Function/Description	Positive Response
EVENTTsss	Program Table EVENT Read Reads the EVENT value (pass condition). sss: Program step (PGMSTEP)	EVENTT123 = T12345 [SP] [SP] [SP] [SP] [CR] [LF] EVENTT123 = IT12345 [SP] [SP] [SP] [CR] [LF] EVENTT123 = NT12345 [SP] [SP] [SP] [CR] [LF] EVENTT123 = DT12345 [SP] [SP] [SP] [CR] [LF] EVENTT123 = SEL1T12345 [CR] [LF] EVENTT123 =:[SP] [SP] [SP] [SP] [SP] [SP] [SP] [SP] [SP] [CR] [LF]
EVENTTsss = nnnn- nnnn	Program Table EVENT Write Sets the EVENT value (pass condition). sss: Program step (PGMSTEP) Settings: I: INPOSITION (positioning completed) active N: NEAR (near position) active D: DEN (positioning reference distribution completed) active SELx: SEL input signal active (x = 0 to 7) Tnnnnn: Time elapsed (ms) since the program step started. (0 ≤ nnnnn ≤ 99999) ITnnnnn: Time elapsed (ms) after the INPOSITION signal became active. (0 ≤ nnnnn ≤ 99999) NTnnnnn: Time elapsed (ms) after the NEAR signal became active. (0 ≤ nnnnn ≤ 99999) DTnnnnn: Time elapsed (ms) after the DEN signal became active. (0 ≤ nnnnn ≤ 99999) SELxnnnnn: Time elapsed (ms) after the SEL input signal became active. (x = 0 to 7, 0 ≤ nnnnn ≤ 99999) “.”: Continues the previously executed program step's specification.	OK
LOOPTsss	Program Table LOOP Read Reads the LOOP value (number of repetitions). sss: Program step (PGMSTEP)	LOOPT123 = 12345 [CR] [LF]
LOOPTsss = nnnnn	Program Table LOOP Write Sets the LOOP value (number of repetitions). sss: Program step (PGMSTEP) Setting: 1 ≤ nnnnn ≤ 99999	OK
NEXTTsss	Program Table NEXT Read Reads the NEXT value (link destination). sss: Program step (PGMSTEP)	NEXTT123 = 12345 [CR] [LF] NEXTT123 = END [SP] [SP] [CR] [LF]
NEXTTsss = nnn	Program Table NEXT Write Sets the NEXT value (link destination). sss: Program step (PGMSTEP) Settings: 0 ≤ nnn ≤ 255: Program step (PGMSTEP) END: End	OK

* If you set PhB54 to 1 (Enable Expansion Mode), the command name, the command setting range, and the acknowledgment will change. Refer to the following section for details.

 12.4 Speed/Position Expansion Function Setting on page 12-8

Program Table Operation Commands

The following table shows the Program Table Operation Commands

Serial Command	Function/Description	Positive Response
STARTsss	<p>Program Table Operation Start</p> <p>Starts program table operation from program step sss. sss: Program step (PGMSTEP)</p> <p>When program table operation has been interrupted by the STOP command or other method, the STARTsss command can be executed to cancel that operation and simultaneously start a new program table operation from program step sss.</p>	OK
START	<p>Program Table Operation Restart</p> <p>When program table operation has been interrupted by the STOP command or other method, the START command can be executed to restart that operation (clearing the hold state). If program table operation was canceled or ended, the START command will start a new program table operation from the program step (sss) that was specified in the last STARTsss command.</p>	OK
STOP	<p>Program Table Operation Interruption</p> <p>Interrupts a program table operation. When a positioning is in progress, the remainder of the operation (remaining distance) is put on hold.</p>	OK
PGMRES	<p>Program Table Operation Reset</p> <p>When program table operation has been interrupted by the STOP command or other method, the PGMRES command can be executed to cancel that operation (reset program table operation.)</p>	OK

14.8.5 Editing a Jog Speed Table

The following commands are used to edit a jog speed table.

Serial Command	Function/Description	Positive Response
JSPDSTORE	JOG Speed Table Save Saves the JOG speed table in flash memory. Once JSPDSTORE is executed, the jog speed table will be retained after the control power supply is turned OFF. Because the JOG speed table is stored in flash memory, this command must not be executed frequently.	OK
JSPDINIT	JOG Speed Table Initialization Resets all values in the JOG speed table to their default settings.	OK
JSPDTdd*	JOG Speed Table Read Reads the JOG speed table setting for the specified number. dd: JOG speed number	JSPDT123 = 12345678 [CR] [LF]
JSPDTdd = nnnnnnnn*	JOG Speed Table Write Sets the JOG speed table setting for the specified number. dd: JOG speed number Settings: $1 \leq nnnnnnnn \leq 99999999$ [1,000 reference units/min]	OK

* If you set PhB54 to 1 (Enable Expansion Mode), the command name, the command setting range, and the acknowledgment will change. Refer to the following section for details.

 12.4 Speed/Position Expansion Function Setting on page 12-8

14.8.6 Editing a ZONE Table

The following commands are used to edit a ZONE table.

Serial Command	Function/Description	Positive Response
ZONESTORE	ZONE Table Save Saves the ZONE table in flash memory. Once ZONESTORE is executed, the ZONE table will be retained after the control power supply is turned OFF. Because the ZONE table is stored in flash memory, this command must not be executed frequently.	OK
ZONEINIT	ZONE Table Initialization Resets all values in the ZONE table to their default settings.	OK
ZONEPTzz*	ZONE Table ZONEP Read Reads the ZONEP value (positive side zone boundary position.) zz: ZONE number (ZONE ID)	ZONEPT123 = +12345678 [CR] [LF]

Continued on next page.

Continued from previous page.

Serial Command	Function/Description	Positive Response
ZONEPTzz = nnnnnnnn*	<p>ZONE Table ZONEP Write</p> <p>Sets the ZONEP value (positive side zone boundary position). zz: ZONE number (ZONE ID)</p> <p>Settings: -99999999 ≤ nnnnnnnn ≤ +99999999</p>	OK
ZONENTzz*	<p>ZONE Table ZONEN Read</p> <p>Reads the ZONEN value (negative side zone boundary position.) zz: ZONE number (ZONE ID)</p>	ZONENT123 = +12345678 [CR] [LF]
ZONENTzz = nnnnnnnn*	<p>ZONE Table ZONEN Write</p> <p>Sets the ZONEN value (negative side zone boundary position). zz: ZONE number (ZONE ID)</p> <p>Settings: -99999999 ≤ nnnnnnnn ≤ +99999999</p>	OK

* If you set PnB54 to 1 (Enable Expansion Mode), the command name, the command setting range, and the acknowledgment will change. Refer to the following section for details.

 12.4 Speed/Position Expansion Function Setting on page 12-8

14.8.7 Editing Parameters, Monitoring, and Utility Functions



Parameter Editing Commands

The following commands are used to edit parameters.

Serial Command	Function/Description	Positive Response
PRMppp	<p>Parameter Read</p> <p>Reads a parameter. ppp: Parameter number (Pn number)</p> <p>Example: Reading PnB00 Command: 1PRMB00 [CR] Response: 1PRMB00 = 00000001 [CR] [LF]</p>	<p>An 8-digit signed decimal value is returned for commands PRM124, PRM164, PRM165, PRM550 to PRM553, PRMB21, PRMB23, PRMB25, PRMB39, and PRMB50. Example: PRMB21 = +12345678 [CR] [LF]</p> <p>Eight-digit hexadecimal for PRM000 to PRM002, PRM006 to PRM009, PRM00A, PRM00B to PRM00D, PRM00F, PRM010, PRM040, PRM080, PRM081, PRM10B, PRM139, PRM140, PRM160, RPM170, PRM310, PRM408, PRM416, PRM423, PRM460, PRM530, PRM587, PRMB53, and PRMB54, and PRM000 = 00001234 [CR] [LF] is returned.</p> <p>A 10-digit unsigned decimal value is returned for commands PRM20E, PRM210, PRM212, PRM520, PRM526, and PRM531. Example: PRM20E=1234567890 [CR] [LF]</p> <p>An 8-digit unsigned decimal value is returned for all other parameters. Example: PRMB00 = 12345678 [CR] [LF]</p>

Continued on next page.

Continued from previous page.

Serial Command	Function/Description	Positive Response
PRMppp = (±) nnnnnnn*	<p>Parameter Write</p> <p>Sets a parameter. ppp: Parameter number (Pn number)</p> <p>Parameters are stored in EEPROM, so the settings will be retained after the control power supply is turned OFF. Because the value is stored in EEPROM, this command must not be used if the setting needs to be changed frequently. In such a case, use the TRMppp = (±) nnnnnnn command.</p> <p>Note: The settings of parameters are updated at one of the following two times. Immediately: The setting of the parameter is enabled immediately. After restart: The setting of the parameter is enabled the next time the control power supply is turned OFF and ON again.</p> <p>Refer to the following section for the timing of enabling parameter settings.  16.2.2 List of Parameters on page 16-4</p>	OK
TRMppp = (±) nnnnnnn*	<p>Temporary Parameter Write</p> <p>Sets a parameter. ppp: Parameter number (Pn number)</p> <p>The PRMppp = (±) nnnnnnn command stores the parameter setting in EEPROM, but the TRMppp = (±) nnnnnnn command does not. Because this command does not write the setting in EEPROM, it can be used to change settings frequently.</p> <p>Note: The settings of parameters are updated at one of the following two times. Immediately: The setting of the parameter is enabled immediately. After restart: The setting of the parameter is enabled the next time the control power supply is turned OFF and ON again. You cannot use the TRMppp = (±) nnnnnnn command to edit parameters that are enabled after turning the control power supply OFF and ON again. Use the PRMppp = (±) nnnnnnn command.</p> <p>Refer to the following section for the timing of enabling parameter settings.  16.2.2 List of Parameters on page 16-4</p>	OK
PRMINIT	<p>Parameter Initialization</p> <p>Resets all parameters to their default settings. After executing PRMINIT, turn the control power supply OFF and ON.</p>	OK

* If you set PnB54 to 1 (Enable Expansion Mode), the command name will change. Refer to the following section for details.

 12.4 Speed/Position Expansion Function Setting on page 12-8

Monitor and Utility Function Commands

The following table shows the Monitor and Utility Function Commands.

Serial Command	Function/Description	Positive Response
ALM	Alarm or Warning Read	<p>One of the following responses is returned depending on the status.</p> <ul style="list-style-type: none"> • ALM [SP] A.xxx [SP] [CR] [LF] (The "xxx" is the SERVOPACK's alarm/warning code.) • ALM [SP] ExxA [SP] [CR] [LF] (ExxA is the INDEXER Module's alarm code.) • ALM [SP] HBB [SP] [CR] [LF] • ALM [SP] P-OT [SP] [CR] [LF] • ALM [SP] N-OT [SP] [CR] [LF] • ALM [SP] P-LS [SP] [CR] [LF] • ALM [SP] N-LS [SP] [CR] [LF] • ALM [SP] BB [SP] [SP] [SP] [CR] [LF] • ALM [SP] HOLD [SP] [CR] [LF] • ALM [SP] INPOS [CR] [LF] • ALM [SP] NEAR [SP] [CR] [LF] • ALM [SP] RUN [SP] [SP] [CR] [LF] • ALM [SP] . [SP] [SP] [SP] [SP] [CR] [LF]
ALMn	Alarm History Read (0 ≤ n ≤ 9)	<p>One of the following responses is returned depending on the status: No alarm, SERVOPACK alarm, or INDEXER Module alarm.</p> <ul style="list-style-type: none"> • ALM1 = NONE [CR] [LF] • ALM1 = A.xxx [CR] [LF] • ALM1 = ExxA [CR] [LF]
ERR	Most Recent Error Read	<p>One of the following responses is returned. A response of "NONE" indicates that no errors have occurred.</p> <ul style="list-style-type: none"> • ERR [SP] NONE [SP] [CR] [LF] • ERR [SP] ExxE [SP] [CR] [LF]
IN1	SERVOPACK Input Signal Monitor	<p>IN1 = 01010101 [CR] [LF]</p> <p>0: Photocoupler OFF 1: Photocoupler ON</p> <p>Bit 0: /S-ON Bit 1: /ALM-RST Bit 2: P-OT Bit 3: N-OT Bit 4: /DEC Bit 5: Not used (Invalid) Bit 6: /RGRT Bit 7: Not used (Always 0)</p>
IN2	INDEXER Module Input Signal Monitor	<p>IN2 = 10101010101 [CR] [LF]</p> <p>0: Photocoupler OFF 1: Photocoupler ON</p> <p>Bit 0: /MODE 0/1 Bit 1: /START-STOP; /HOME Bit 2: /PGMRES; /JOGP Bit 3: /SEL0; /JOGN Bit 4: /SEL1; /JOG0 Bit 5: /SEL2; /JOG1 Bit 6: /SEL3; /JOG2 Bit 7: /SEL4; /JOG3 Bit 8: /SEL5 Bit 9: /SEL6 Bit 10: /SEL7</p>

Continued on next page.

Continued from previous page.

Serial Command	Function/Description	Positive Response
IN2TESTbbbbbbbbbb	<p>INDEXER Module Input Signal Specification</p> <p>The actual signal is ignored and the input signal is forcibly set to the specified status. This command is used to test operation when the actual signal line is not connected.</p> <p>b = 0: Photocoupler OFF b = 1: Photocoupler ON</p> <p>Bit 0: /MODE 0/1 Bit 1: /START-STOP; /HOME Bit 2: /PGMRES; /JOGP Bit 3: /SEL0; /JOGN Bit 4: /SEL1; /JOG0 Bit 5: /SEL2; /JOG1 Bit 6: /SEL3; /JOG2 Bit 7: /SEL4; /JOG3 Bit 8: /SEL5 Bit 9: /SEL6 Bit 10: /SEL7</p> <p>IN2TESTEND: Return to actual signal status.</p> <p>Note: Error E56E will occur if fewer than 11 digits (bbbbbbbbbb) are specified in the command. If operation is being performed in Mode 0 (program table operation mode), /MODE0/1 must be set to 1 before /START-STOP is set to 1. If operation is being performed in Mode 1 (homing or JOG speed table operation mode), /MODE0/1 must be set to 0 before /HOME, /JOGP, or /JOGN is set to 1.</p>	OK
IN3	Safety Input Signal Monitor	<p>IN3 = 01010101 [CR] [LF]</p> <p>0: Photocoupler OFF 1: Photocoupler ON</p> <p>Bit 0: /HWBB1 Bit 1: /HWBB2 Bit 2 to Bit 7: Not used (indefinite)</p>
OUT1	SERVOPACK Output Signal Monitor	<p>OUT1 = 01010101 [CR] [LF]</p> <p>0: Photocoupler OFF 1: Photocoupler ON</p> <p>Bit 0: ALM Bit 1: /WRN Bit 2: /BK Bit 3: /S-RDY Bit 4: /ALO1 Bit 5: /ALO2 Bit 6: /ALO3 Bit 7: Not used (Always 0)</p>

Continued on next page.

Continued from previous page.

Serial Command	Function/Description	Positive Response
OUT2	INDEXER Module Output Signal Monitor	OUT2 = 101010101 [CR] [LF] 0: Photocoupler OFF 1: Photocoupler ON Bit 0: /INPOSITION Bit 1: /POUT0 Bit 2: /POUT1 Bit 3: /POUT2 Bit 4: /POUT3 Bit 5: /POUT4 Bit 6: /POUT5 Bit 7: /POUT6 Bit 8: /POUT7
OUT2TESTbbbbbbbb	INDEXER Module Output Signal Specification Forcibly sets the output signals to the specified status. This command is used to check wiring. b = 0: Photocoupler OFF b = 1: Photocoupler ON Bit 0: /INPOSITION Bit 1: /POUT0 Bit 2: /POUT1 Bit 3: /POUT2 Bit 4: /POUT3 Bit 5: /POUT4 Bit 6: /POUT5 Bit 7: /POUT6 Bit 8: /POUT7 OUT2TESTEND: Clears the forced signal status. Note: Error E56E will occur if fewer than 9 digits (bbbbbbbb) are specified in the command.	OK
POUT	POUT Monitor	POUT [SP] NNNAZZZZ [CR] [LF] Bit 0: /POUT0 Bit 1: /POUT1 Bit 2: /POUT2 Bit 3: /POUT3 Bit 4: /POUT4 Bit 5: /POUT5 Bit 6: /POUT6 Bit 7: /POUT7
PGMSTEP	Program Step (PGMSTEP) Monitor	PGMSTEP = 12345 [CR] [LF]
EVTIME	Program Table Operation Event Elapsed Time Monitor [ms]	EVTIME = 12345 [CR] [LF]
LOOP	Program Table Operation LOOP Pass Through Monitor	LOOP = 12345 [CR] [LF]
MONn	Monitor Read (1 ≤ n ≤ 11) See following description of STS to RDST.	See following description of the responses for STS to RDST.

Continued on next page.

Continued from previous page.

Serial Command	Function/Description	Positive Response
STS or MON6	Status Flag Monitor	STS = 1010101 [CR] [LF] Bit 0: ON (1) when the /INPOSITION (positioning completed) signal is active. Bit 1: ON (1) when the NEAR (near position) signal is active. Bit 2: ON (1) when the DEN (positioning reference distribution completed) signal is active. Bit 3: ON (1) when positioning or program operation is interrupted (on hold). Bit 4: ON (1) during program operation. Bit 5: ON (1) when the current (torque) is being limited. Bit 6: ON (1) when the main power supply is ON.
PUN or MON1*	Position Reference Current Position	PUN = +12345678 [CR] [LF]
PFB or MON7*	Current (Actual) Motor Position Monitor	PFB = +12345678 [CR] [LF]
POS or MON8*	Target Position Monitor	POS = +12345678 [CR] [LF]
DST or MON9*	Target Distance Monitor	DST = +12345678 [CR] [LF]
RPOS or MON10*	Registration Target Position Monitor	RPOS = +12345678 [CR] [LF]
RDST or MON11*	Registration Target Distance Monitor	RDST = 12345678 [CR] [LF]
NFB or MON3	Motor Speed Monitor [min ⁻¹] (rotational motor) Motor Speed Monitor [mm/s] (linear motor)	NFB = +12345678 [CR] [LF]
TREF or MON5	Internal Torque Reference Monitor [%]	TREF = +12345678 [CR] [LF]
NREF or MON4	Speed Reference Monitor [min ⁻¹] (rotational motor) Speed Reference Monitor [mm/s] (linear motor)	NREF = 12345678 [CR] [LF]
PER or MON2*	Position Error Monitor [Reference units]	PER = +12345678 [CR] [LF]
TRMS	Cumulative Load Ratio Monitor [%]	TRMS = 12345678 [CR] [LF]
RGRMS	Regeneration Load Ratio Monitor [%]	TGRMS = 12345678 [CR] [LF]
DBRMS	Dynamic-Brake Load Ratio Monitor [%]	DBRMS = 12345678 [CR] [LF]
HALLSENS	Hall Sensor Monitor for Linear Servomotor	HALLSENS=1[SP]LLH[CR][LF] A number between 0 and 7 ↳ Status of phase W [H or L] ↳ Status of phase V [H or L] ↳ Status of phase U [H or L]
TYPE	INDEXER Module Model Code Display INDEXER Module Model Code = 0A03	TYPE = 00000A03 [CR] [LF] (Displayed in hexadecimal)
YSPEC	INDEXER Module Special Specification No. Display	YSPEC = 12345678 [CR] [LF]
VER	INDEXER Module Firmware Version Display	VER = 00001234 [CR] [LF] (Displayed in hexadecimal)
SVTYPE	SERVOPACK Model Code Display SGD7S-□□□□E0A = 73	SVTYPE = 00000073 [CR] [LF] (Displayed in hexadecimal)
SVYSPEC	SERVOPACK Special Specification No. Display	SVYSPEC = 12345678 [CR] [LF]
SVVER	SERVOPACK Firmware Version Display	SVVER = 12345678 [CR] [LF] (Displayed in hexadecimal)

Continued on next page.

Continued from previous page.

Serial Command	Function/Description	Positive Response
MTTYPE	Motor Model Code Display <div style="text-align: center; margin-left: 100px;"> 0 1 1 1 └──┬──┬──┬── Voltage Servomotor model </div> 00 = 100 VAC 11 = SGMMJ 01 = 200 VAC 32 to 39 = SGMCS 02 = 400 VAC 40 = linear motor 60 = SGMAV 62 = SGMSV 63 = SGMGV 6D = SGMJV 6E = SGMEV 72 to 79 = SGMCV A0 = SGM7A A1 = SGM7P A3 = SGM7G AD = SGM7J FF = Undefined motor	MTTYPE = 00001234 [CR] [LF] (Displayed in hexadecimal)
MTSIZE	Motor Capacity Display [10 W]	MTSIZE = 12345678 [CR] [LF]
PGTYPE	Encoder Model Code Display 000D: 3-bit incremental encoder 0011: 17-bit incremental encoder 0014: 20-bit incremental encoder 0018: 24-bit incremental encoder 0110: 16-bit absolute encoder 0111: 17-bit absolute encoder 0114: 20-bit absolute encoder (multi-turn) 0116: 22-bit absolute encoder (multi-turn) 0118: 24-bit absolute encoder (multi-turn) 0214: 20-bit absolute encoder (within one rotation) 0216: 22-bit absolute encoder (within one rotation) When fully-closed loop control is selected and linear motor is used: 0008: 8-bit serial converter unit 000C: 12-bit serial converter unit 0008: 8-bit incremental scale 0009: 9-bit incremental scale 000A: 10-bit incremental scale 000D: 13-bit incremental scale 0109: 9-bit absolute scale 010A: 10-bit absolute scale Note: When fully-closed loop control is selected, the external encoder's information is displayed.	PGTYPE = 00001234 [CR] [LF] (Displayed in hexadecimal)
PGVER	Encoder Firmware Version Display Note: When fully-closed loop control is selected, the external encoder's information is displayed.	PGVER = 00001234 [CR] [LF] (Displayed in hexadecimal)
ABSPGRES	Absolute Encoder Reset	OK
MLTLIMSET	Multi-turn Limit Setting	OK
ALMTRCCLR	Alarm Trace Clear	OK
CURZERO	Motor Current Zero Adjustment	OK

* If you set PnB54 to 1 (Enable Expansion Mode), the acknowledgement will change. Refer to the following section for details.

12.4 Speed/Position Expansion Function Setting on page 12-8

Maintenance

15

This chapter provides information on the meaning of, causes of, and corrections for alarms and warnings.

15.1 Inspections and Part Replacement 15-2

- 15.1.1 Inspections 15-2
- 15.1.2 Guidelines for Part Replacement 15-2
- 15.1.3 Replacing the Battery 15-3

15.2 Alarm Displays 15-5

- 15.2.1 List of Alarms 15-5
- 15.2.2 Troubleshooting Alarms 15-13
- 15.2.3 INDEXER Module Alarm Displays and Troubleshooting 15-46
- 15.2.4 Resetting INDEXER Alarms 15-49
- 15.2.5 Displaying the INDEXER Alarm History 15-51
- 15.2.6 Clearing the INDEXER Alarm History 15-52
- 15.2.7 Resetting Alarms Detected in Option Modules 15-53
- 15.2.8 Resetting Motor Type Alarms 15-55

15.3 Warning Displays 15-57

- 15.3.1 List of Warnings 15-57
- 15.3.2 Troubleshooting Warnings 15-59
- 15.3.3 INDEXER Module Error Displays and Troubleshooting 15-65

15.4 Troubleshooting Based on the Operation and Conditions of the Servomotor . . 15-73

15.1 Inspections and Part Replacement

This section describes inspections and part replacement for SERVOPACKs.

15.1.1 Inspections

Perform the inspections given in the following table at least once every year for the SERVO-PACK. Daily inspections are not required.

Item	Frequency	Inspection	Correction
Exterior	At least once a year	Check for dust, dirt, and oil on the surfaces.	Clean with compressed air or a cloth.
Loose Screws		Check for loose terminal block and connector screws and for other loose parts.	Tighten any loose screws or other loose parts.

15.1.2 Guidelines for Part Replacement

The following electric or electronic parts are subject to mechanical wear or deterioration over time. Use one of the following methods to check the standard replacement period.

- Use the service life prediction function of the SERVOPACK. Refer to the following section for information on service life predictions.

 9.4 Monitoring Product Life on page 9-14

- Use the following table.

Part	Standard Replacement Period	Remarks
Cooling Fan	4 years to 5 years	The standard replacement periods given on the left are for the following operating conditions. <ul style="list-style-type: none"> • Surrounding air temperature: Annual average of 30°C • Load factor: 80% max. • Operation rate: 20 hours/day max.
Electrolytic Capacitor	10 years	
Relays	100,000 power ON operations	Power ON frequency: Once an hour
Battery	3 years without power supplied	Surrounding temperature without power supplied: 20°C

When any standard replacement period is close to expiring, contact your Yaskawa representative. After an examination of the part in question, we will determine whether the part should be replaced.



Important

The parameters of any SERVOPACKs that are sent to Yaskawa for part replacement are reset to the default settings before they are returned to you. Always keep a record of the parameter settings. And, always confirm that the parameters are properly set before starting operation.

15.1.3 Replacing the Battery

If the battery voltage drops to approximately 2.7 V or less, an A.830 alarm (Encoder Battery Alarm) or an A.930 warning (Encoder Battery Warning) will be displayed.

If this alarm or warning is displayed, the battery must be replaced. Refer to the following section for the battery replacement procedure.

 *Battery Replacement Procedure on page 15-3*

Battery Alarm/Warning Selection

Whether to display an alarm or a warning is determined by the setting of Pn008 = n.□□□X (Low Battery Voltage Alarm/Warning Selection).

Parameter	Meaning	When Enabled	Classification
Pn008	n.□□□0 (default setting)	After restart	Setup
	n.□□□1		

- Pn008 = n.□□□0
The ALM (Servo Alarm) signal is output for up to five seconds when the control power supply is turned ON, and then the battery voltage is monitored for four seconds. No alarm will be displayed even if the battery voltage drops below the specified value after these four seconds.
- Pn008 = n.□□□1
The ALM (Servo Alarm) signal is output for up to five seconds when the control power supply is turned ON, and then the battery voltage is monitored continuously.

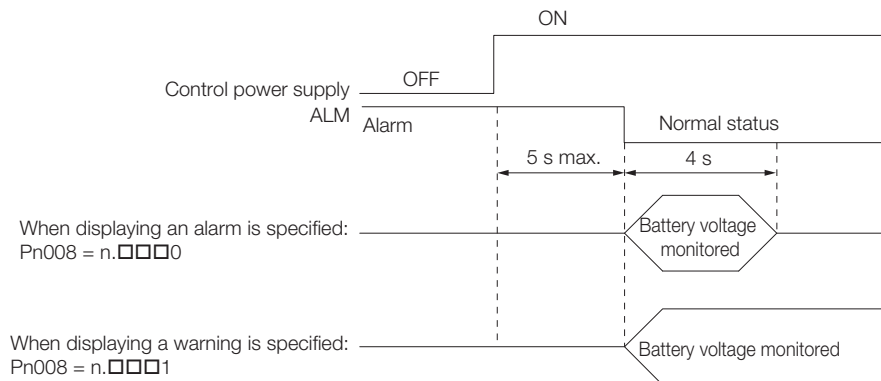

Battery Replacement Procedure

◆ When Installing a Battery on the Host Controller

1. Turn ON only the control power supply to the SERVOPACK.
2. Remove the old battery and mount a new battery.
3. Turn OFF the control power supply to the SERVOPACK to clear the A.830 alarm (Absolute Encoder Battery Error).
4. Turn ON the control power supply to the SERVOPACK again.
5. Make sure that the alarm has been cleared and that the SERVOPACK operates normally.

◆ When Using an Encoder Cable with a Battery Case

1. Turn ON only the control power supply to the SERVOPACK.

 If you remove the Battery or disconnect the Encoder Cable while the control power supply to the SERVOPACK is OFF, the absolute encoder data will be lost.

Important

2. Open the cover of the Battery Case.

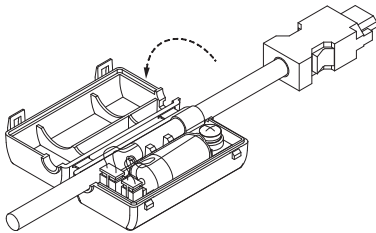

3. Remove the old Battery and mount a new Battery.

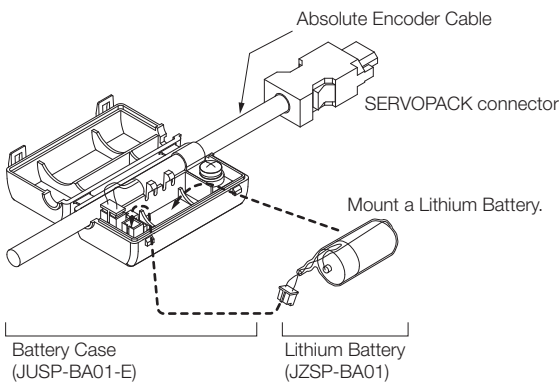

4. Close the cover of the Battery Case.

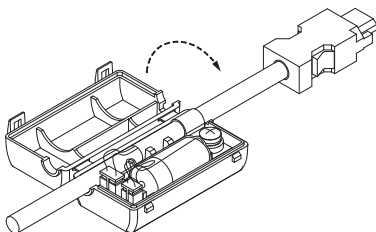



5. Turn OFF the power supply to the SERVOPACK to clear the A.830 alarm (Absolute Encoder Battery Error).
6. Turn ON the power supply to the SERVOPACK.
7. Make sure that the alarm has been cleared and that the SERVOPACK operates normally.

15.2 Alarm Displays

If an error occurs in the SERVOPACK, the status is displayed as described below.

◆ Status Display

SERVOPACK Panel Display	The alarm number will be displayed. Refer to the following section for details.  1.5.1 Panel Display on page 1-10
Indicators	Green indicator: Remains unlit Red indicator: Remains lit Refer to the following section for details.  1.5.2 Indicators on page 1-11
Digital Operator	The alarm code is displayed at the top left of the screen.
Response to the Alarm or Warning Read Command (ALM)	Alarm code
Response to the Most Recent Error Read Command (ERR)	No change
ALM Signal	The alarm signal turns ON. (The photocoupler turns OFF.)
/WARN Signal	No change

A list of the alarms that may occur and the causes of and corrections for those alarms are given below.

15.2.1 List of Alarms

This section gives the alarm names, alarm meanings, alarm stopping methods, alarm reset possibilities, and alarm code outputs in order of the alarm numbers.

Servomotor Stopping Method for Alarms

Refer to the following section for information on the stopping method for alarms.

 5.12.2 Servomotor Stopping Method for Alarms on page 5-36

Alarm Reset Possibility

Yes: You can use an alarm reset to clear the alarm. However, this assumes that the cause of the alarm has been removed.

No: You cannot clear the alarm.

List of Alarms

Alarm Number	Alarm Name	Alarm Meaning	Servo-motor Stopping Method	Alarm Reset Possible?	Alarm Code Output		
					/ALO1	/ALO2	/ALO3
A.020	Parameter Checksum Error	There is an error in the parameter data in the SERVOPACK.	Gr.1	No	H	H	H
A.021	Parameter Format Error	There is an error in the parameter data format in the SERVOPACK.	Gr.1	No			
A.022	System Checksum Error	There is an error in the parameter data in the SERVOPACK.	Gr.1	No			
A.024	System Alarm	An internal program error occurred in the SERVOPACK.	Gr.1	No			
A.025	System Alarm	An internal program error occurred in the SERVOPACK.	Gr.1	No			
A.030	Main Circuit Detector Error	There is an error in the detection data for the main circuit.	Gr.1	Yes			
A.040	Parameter Setting Error	A parameter setting is outside of the setting range.	Gr.1	No			
A.041	Encoder Output Pulse Setting Error	The setting of Pn212 (Encoder Output Pulses) or Pn281 (Encoder Output Resolution) is outside of the setting range or does not satisfy the setting conditions.	Gr.1	No			
A.042	Parameter Combination Error	The combination of some parameters exceeds the setting range.	Gr.1	No			
A.044	Semi-Closed/Fully-Closed Loop Control Parameter Setting Error	The settings of the Option Module and Pn002 = n.X□□□ (External Encoder Usage) do not match.	Gr.1	No			
A.04A	Parameter Setting Error 2	There is an error in setting of parameters reserved by the system.	Gr.1	No			
A.050	Combination Error	The capacities of the SERVOPACK and Servomotor do not match.	Gr.1	Yes			
A.051	Unsupported Device Alarm	An unsupported device was connected.	Gr.1	No			
A.070	Motor Type Change Detected	The connected motor is a different type of motor from the previously connected motor.	Gr.1	No			
A.080	Linear Encoder Pitch Setting Error	The setting of Pn282 (Linear Encoder Pitch) has not been changed from the default setting.	Gr.1	No			
A.0b0	Invalid Servo ON Command Alarm	The /S-ON (Servo ON) signal was input from the host controller after a utility function that turns ON the Servomotor was executed.	Gr.1	Yes			
A.100	Overcurrent Detected	An overcurrent flowed through the power transformer or the heat sink overheated.	Gr.1	No	L	H	H
A.101	Motor Overcurrent Detected	The current to the motor exceeded the allowable current.	Gr.1	No			
A.300	Regeneration Error	There is an error related to regeneration.	Gr.1	Yes	L	L	H
A.320	Regenerative Overload	A regenerative overload occurred.	Gr.2	Yes			
A.330	Main Circuit Power Supply Wiring Error	<ul style="list-style-type: none"> The AC power supply input setting or DC power supply input setting is not correct. The power supply wiring is not correct. 	Gr.1	Yes			

Continued on next page.

Continued from previous page.

Alarm Number	Alarm Name	Alarm Meaning	Servo-motor Stopping Method	Alarm Reset Possible?	Alarm Code Output		
					/ALO1	/ALO2	/ALO3
A.400	Overvoltage	The main circuit DC voltage is too high.	Gr.1	Yes	H	H	L
A.410	Undervoltage	The main circuit DC voltage is too low.	Gr.2	Yes	H	H	L
A.510	Overspeed	The motor exceeded the maximum speed.	Gr.1	Yes	L	H	L
A.511	Encoder Output Pulse Overspeed	<ul style="list-style-type: none"> Rotary Servomotor: The pulse output speed for the setting of Pn212 (Encoder Output Pulses) was exceeded. Linear Servomotor: The motor speed upper limit for the setting of Pn281 (Encoder Output Resolution) was exceeded. 	Gr.1	Yes			
A.520	Vibration Alarm	Abnormal oscillation was detected in the motor speed.	Gr.1	Yes			
A.521	Autotuning Alarm	Vibration was detected during autotuning for the tuning-less function.	Gr.1	Yes			
A.550	Maximum Speed Setting Error	The setting of Pn385 (Maximum Motor Speed) is greater than the maximum motor speed.	Gr.1	Yes			
A.710	Instantaneous Overload	The Servomotor was operating for several seconds to several tens of seconds under a torque that largely exceeded the rating.	Gr.2	Yes	L	L	L
A.720	Continuous Overload	The Servomotor was operating continuously under a torque that exceeded the rating.	Gr.1	Yes			
A.730	Dynamic Brake Overload	When the dynamic brake was applied, the rotational or linear kinetic energy exceeded the capacity of the dynamic brake resistor.	Gr.1	Yes			
A.731							
A.740	Inrush Current Limiting Resistor Overload	The main circuit power supply was frequently turned ON and OFF.	Gr.1	Yes			
A.7A1	Internal Temperature Error 1 (Control Board Temperature Error)	The surrounding temperature of the control PCB is abnormal.	Gr.2	Yes			
A.7A2	Internal Temperature Error 2 (Power Board Temperature Error)	The surrounding temperature of the power PCB is abnormal.	Gr.2	Yes			
A.7A3	Internal Temperature Sensor Error	An error occurred in the temperature sensor circuit.	Gr.2	No			
A.7Ab	SERVOPACK Built-in Fan Stopped	The fan inside the SERVOPACK stopped.	Gr.1	Yes			
A.810	Encoder Backup Alarm	The power supplies to the encoder all failed and the position data was lost.	Gr.1	No			
A.820	Encoder Checksum Alarm	There is an error in the checksum results for encoder memory.	Gr.1	No			
A.830	Encoder Battery Alarm	The battery voltage was lower than the specified level after the control power supply was turned ON.	Gr.1	Yes	H	H	H
A.840	Encoder Data Alarm	There is an internal data error in the encoder.	Gr.1	No	H	H	H
A.850	Encoder Overspeed	The encoder was operating at high speed when the power was turned ON.	Gr.1	No			
A.860	Encoder Overheated	The internal temperature of encoder is too high.	Gr.1	No			

Continued on next page.

15.2 Alarm Displays

15.2.1 List of Alarms

Continued from previous page.

Alarm Number	Alarm Name	Alarm Meaning	Servo-motor Stopping Method	Alarm Reset Possible?	Alarm Code Output		
					/ALO1	/ALO2	/ALO3
A.861	Motor Overheated	The internal temperature of motor is too high.	Gr.1	No	H	H	H
A.862	Overheat Alarm	The input voltage (temperature) for the overheat protection input (TH) signal exceeded the setting of Pn61B (Overheat Alarm Level).	Gr.1	Yes			
A.890	Encoder Scale Error	A failure occurred in the linear encoder.	Gr.1	No			
A.891	Encoder Module Error	An error occurred in the linear encoder.	Gr.1	No			
A.8A0	External Encoder Error	An error occurred in the external encoder.	Gr.1	Yes			
A.8A1	External Encoder Module Error	An error occurred in the Serial Converter Unit.	Gr.1	Yes			
A.8A2	External Incremental Encoder Sensor Error	An error occurred in the external encoder.	Gr.1	Yes			
A.8A3	External Absolute Encoder Position Error	An error occurred in the position data of the external encoder.	Gr.1	Yes			
A.8A5	External Encoder Overspeed	An overspeed error occurred in the external encoder.	Gr.1	Yes			
A.8A6	External Encoder Overheated	An overheating error occurred in the external encoder.	Gr.1	Yes			
A.AEF	INDEXER Module Alarm	Some kind of alarm has occurred at the INDEXER Module.	Gr.1	Depends on the Module alarm*1	H	L	L
A.b33	Current Detection Error 3	An error occurred in the current detection circuit.	Gr.1	No	H	H	H
A.bC0	System Alarm 10	Internal program error 10 occurred in the SERVOPACK.	Gr.1	No			
A.bF0	System Alarm 0	Internal program error 0 occurred in the SERVOPACK.	Gr.1	No			
A.bF1	System Alarm 1	Internal program error 1 occurred in the SERVOPACK.	Gr.1	No			
A.bF2	System Alarm 2	Internal program error 2 occurred in the SERVOPACK.	Gr.1	No			
A.bF3	System Alarm 3	Internal program error 3 occurred in the SERVOPACK.	Gr.1	No			
A.bF4	System Alarm 4	Internal program error 4 occurred in the SERVOPACK.	Gr.1	No			
A.bF5	System Alarm 5	Internal program error 5 occurred in the SERVOPACK.	Gr.1	No			
A.bF6	System Alarm 6	Internal program error 6 occurred in the SERVOPACK.	Gr.1	No			
A.bF7	System Alarm 7	Internal program error 7 occurred in the SERVOPACK.	Gr.1	No			
A.bF8	System Alarm 8	Internal program error 8 occurred in the SERVOPACK.	Gr.1	No			

Continued on next page.

Continued from previous page.

Alarm Number	Alarm Name	Alarm Meaning	Servomotor Stopping Method	Alarm Reset Possible?	Alarm Code Output		
					/ALO1	/ALO2	/ALO3
A.C10	Servomotor Out of Control	The Servomotor ran out of control.	Gr.1	Yes			
A.C20	Phase Detection Error	The detection of the phase is not correct.	Gr.1	No	L	H	L
A.C21	Polarity Sensor Error	An error occurred in the polarity sensor.	Gr.1	No			
A.C22	Phase Information Disagreement	The phase information does not match.	Gr.1	No			
A.C50	Polarity Detection Failure	The polarity detection failed.	Gr.1	No	L	H	L
A.C51	Overtravel Detected during Polarity Detection	The overtravel signal was detected during polarity detection.	Gr.1	Yes			
A.C52	Polarity Detection Not Completed	The servo was turned ON before the polarity was detected.	Gr.1	Yes			
A.C53	Out of Range of Motion for Polarity Detection	The travel distance exceeded the setting of Pn48E (Polarity Detection Range).	Gr.1	No			
A.C54	Polarity Detection Failure 2	The polarity detection failed.	Gr.1	No			
A.C80	Encoder Clear Error or Multiturn Limit Setting Error	The multiturn data for the absolute encoder was not correctly cleared or set.	Gr.1	No			
A.C90	Encoder Communications Error	Communications between the encoder and SERVOPACK is not possible.	Gr.1	No			
A.C91	Encoder Communications Position Data Acceleration Rate Error	An error occurred in calculating the position data of the encoder.	Gr.1	No			
A.C92	Encoder Communications Timer Error	An error occurred in the communications timer between the encoder and SERVOPACK.	Gr.1	No			
A.CA0	Encoder Parameter Error	The parameters in the encoder are corrupted.	Gr.1	No			
A.Cb0	Encoder Echoback Error	The contents of communications with the encoder are incorrect.	Gr.1	No			
A.CC0	Multiturn Limit Disagreement	Different multiturn limits have been set in the encoder and the SERVOPACK.	Gr.1	No			
A.CF1	Reception Failed Error in Feedback Option Module Communications	Receiving data from the Feedback Option Module failed.	Gr.1	No			
A.CF2	Timer Stopped Error in Feedback Option Module Communications	An error occurred in the timer for communications with the Feedback Option Module.	Gr.1	No			

Continued on next page.

15.2 Alarm Displays

15.2.1 List of Alarms

Continued from previous page.

Alarm Number	Alarm Name	Alarm Meaning	Servo-motor Stopping Method	Alarm Reset Possible?	Alarm Code Output		
					/ALO1	/ALO2	/ALO3
A.d00	Position Deviation Overflow	The setting of Pn520 (Excessive Position Deviation Alarm Level) was exceeded by the position deviation.	Gr.1	Yes	L	L	H
A.d01	Position Deviation Overflow Alarm at Servo ON	The servo was turned ON after the position deviation exceeded the setting of Pn526 (Excessive Position Deviation Alarm Level at Servo ON) while the servo was OFF.	Gr.1	Yes			
A.d02	Position Deviation Overflow Alarm for Speed Limit at Servo ON	If position deviation remains in the deviation counter, the setting of Pn529 or Pn584 (Speed Limit Level at Servo ON) limits the speed when the servo is turned ON. This alarm occurs if a position reference is input and the setting of Pn520 (Excessive Position Deviation Alarm Level) is exceeded before the limit is cleared.	Gr.2	Yes			
A.d10	Motor-Load Position Deviation Overflow	There was too much position deviation between the motor and load during fully-closed loop control.	Gr.2	Yes	L	L	H
A.d30	Position Data Overflow	The position feedback data exceeded $\pm 1,879,048,192$.	Gr.1	No			

Continued on next page.

Continued from previous page.

Alarm Number	Alarm Name	Alarm Meaning	Servo-motor Stopping Method	Alarm Reset Possible?	Alarm Code Output		
					/ALO1	/ALO2	/ALO3
A.E00	Command Option Module IF Initialization Timeout Error	Communications initialization failed between the SERVOPACK and the Command Option Module.	Gr.2	Yes	H	L	L
A.E02	Command Option Module IF Synchronization Error 1	An synchronization error occurred between the SERVOPACK and the Command Option Module.	Gr.1	Yes			
A.E03	Command Option Module IF Communications Data Error	An error occurred in the data of communications between the SERVOPACK and the Command Option Module.	Gr.1	Yes			
A.E70	Command Option Module Detection Failure	Detection of the Command Option Module failed.	Gr.1	No			
A.E71	Safety Option Module Detection Failure	Detection of the safety option module failed.	Gr.1	No			
A.E72	Feedback Option Module Detection Failure	Detection of the Feedback Option Module failed.	Gr.1	No			
A.E73	Unsupported Command Option Module	An unsupported command option module was connected.	Gr.1	No			
A.E74	Unsupported Safety Option Module	An unsupported safety option module was connected.	Gr.1	No			
A.E75	Unsupported Feedback Option Module	An unsupported feedback option module was connected.	Gr.1	No			
A.E80	Command Option Module Unmatched Error	The command option module was replaced with a different model.	Gr.1	No			
A.EA2	Alarm in Current Communications between the INDEXER Module and SERVOPACK 1	An error occurred in communications between the INDEXER Module and SERVOPACK during operation.	Gr.1	Yes			
A.EA3	Alarm in Current Communications between the INDEXER Module and SERVOPACK 2	An error occurred in communications between the INDEXER Module and SERVOPACK during operation.	Gr.1	Yes			
A.Eb1	Safety Function Signal Input Timing Error	An error occurred in the input timing of the safety function signal.	Gr.1	No			
A.EC8	Gate Drive Error 1	An error occurred in the gate drive circuit.	Gr.1	No			
A.EC9	Gate Drive Error 2	An error occurred in the gate drive circuit.	Gr.1	No			
A.Ed1	Command Option Module IF Command Timeout Error	Processing of command from the command option module was not completed.	Gr.2	Yes			
A.F10	Power Supply Line Open Phase	The voltage was low for more than one second for phase R, S, or T when the main power supply was ON.	Gr.2	Yes			

Continued on next page.

15.2 Alarm Displays

15.2.1 List of Alarms

Continued from previous page.

Alarm Number	Alarm Name	Alarm Meaning	Servo-motor Stopping Method	Alarm Reset Possible?	Alarm Code Output		
					/ALO1	/ALO2	/ALO3
FL-1*2	System Alarm	An internal program error occurred in the SERVOPACK.	-	No			Invalid
FL-2*2							
FL-3*2							
FL-4*2							
FL-5*2							
FL-6*2							
FL-7*2							
CPF00	Digital Operator Communications Error 1	Communications were not possible between the Digital Operator (model: JUSP-OP05A-1-E) and the SERVOPACK (e.g., a CPU error occurred).	-	No			
CPF01	Digital Operator Communications Error 2						

*1. Refer to the following section for details.

 15.2.3 INDEXER Module Alarm Displays and Troubleshooting on page 15-46

*2. These alarms are not stored in the alarm history. They are only displayed on the panel display.

15.2.2 Troubleshooting Alarms

The causes of and corrections for the alarms are given in the following table. Contact your Yaskawa representative if you cannot solve a problem with the correction given in the table.

Alarm Number: Alarm Name	Possible Cause	Confirmation	Correction	Reference
A.020: Parameter Checksum Error (There is an error in the parameter data in the SER- VOPACK.)	The power supply voltage suddenly dropped.	Measure the power supply voltage.	Set the power supply volt- age within the specified range, and initialize the parameter settings.	page 5-10
	The power supply was shut OFF while writing parameter set- tings.	Check the timing of shutting OFF the power supply.	Initialize the parameter settings and then set the parameters again.	
	The number of times that parameters were written exceeded the limit.	Check to see if the parameters were fre- quently changed from the host controller.	The SERVOPACK may be faulty. Replace the SER- VOPACK. Reconsider the method for writing the parame- ters.	–
	A malfunction was caused by noise from the AC power supply, ground, static elec- tricity, or other source.	Turn the power supply to the SERVOPACK OFF and ON again. If the alarm still occurs, noise may be the cause.	Implement countermea- sures against noise.	page 4-6
	Gas, water drops, or cutting oil entered the SERVOPACK and caused failure of the internal components.	Check the installation conditions.	The SERVOPACK may be faulty. Replace the SER- VOPACK.	–
	A failure occurred in the SERVOPACK.	Turn the power supply to the SERVOPACK OFF and ON again. If the alarm still occurs, the SERVOPACK may have failed.	The SERVOPACK may be faulty. Replace the SER- VOPACK.	–
A.021: Parameter For- mat Error (There is an error in the parameter data format in the SERVOPACK.)	The software version of the SERVOPACK that caused the alarm is older than the soft- ware version of the parameters specified to write.	Read the product infor- mation to see if the soft- ware versions are the same. If they are differ- ent, it could be the cause of the alarm.	Write the parameters from another SERVOPACK with the same model and the same software version, and then turn the power OFF and ON again.	page 9-2
	A failure occurred in the SERVOPACK.	–	The SERVOPACK may be faulty. Replace the SER- VOPACK.	–
A.022: System Check- sum Error (There is an error in the parameter data in the SER- VOPACK.)	The power supply voltage suddenly dropped.	Measure the power supply voltage.	The SERVOPACK may be faulty. Replace the SER- VOPACK.	–
	The power supply was shut OFF while setting a utility func- tion.	Check the timing of shutting OFF the power supply.	The SERVOPACK may be faulty. Replace the SER- VOPACK.	–
	A failure occurred in the SERVOPACK.	Turn the power supply to the SERVOPACK OFF and ON again. If the alarm still occurs, the SERVOPACK may have failed.	The SERVOPACK may be faulty. Replace the SER- VOPACK.	–

Continued on next page.

15.2 Alarm Displays

15.2.2 Troubleshooting Alarms

Continued from previous page.

Alarm Number: Alarm Name	Possible Cause	Confirmation	Correction	Reference
A.024: System Alarm (An internal program error occurred in the SERVOPACK.)	A failure occurred in the SERVOPACK.	—	The SERVOPACK may be faulty. Replace the SERVOPACK.	—
A.025: System Alarm (An internal program error occurred in the SERVOPACK.)	A failure occurred in the SERVOPACK.	—	The SERVOPACK may be faulty. Replace the SERVOPACK.	—
A.030: Main Circuit Detector Error	A failure occurred in the SERVOPACK.	—	The SERVOPACK may be faulty. Replace the SERVOPACK.	—
	The jumper between the DC Reactor terminals (⊖1 and ⊖2) was removed or there is faulty contact.	—	Correct the wiring between the DC Reactor terminals.	—
	The cable between the DC Reactor and SERVOPACK is not wired correctly or there is a faulty contact.			
A.040: Parameter Setting Error (A parameter setting is outside of the setting range.)	The SERVOPACK and Servomotor capacities do not match each other.	Check the combination of the SERVOPACK and Servomotor capacities.	Select a proper combination of SERVOPACK and Servomotor capacities.	page 1-16
	The motor parameter file was not written to the linear encoder. (This applies only when not using a Serial Converter Unit.)	Check to see if the motor parameter file was written to the linear encoder.	Write the motor parameter file to the linear encoder.	page 5-17
	A failure occurred in the SERVOPACK.	—	The SERVOPACK may be faulty. Replace the SERVOPACK.	—
	A parameter setting is outside of the setting range.	Check the setting ranges of the parameters that have been changed.	Set the parameters to values within the setting ranges.	—
	The electronic gear ratio is outside of the setting range.	Check the electronic gear ratio. The ratio must be within the following range: $0.001 < (Pn20E/Pn210) < 64,000$.	Set the electronic gear ratio in the following range: $0.001 < (Pn20E/Pn210) < 64,000$.	page 5-42
A.041: Encoder Output Pulse Setting Error	The setting of Pn212 (Encoder Output Pulses) or Pn281 (Encoder Output Resolution) is outside of the setting range or does not satisfy the setting conditions.	Check the setting of Pn212 or Pn281.	Set Pn212 or Pn281 to an appropriate value.	page 6-15

Continued on next page.

Continued from previous page.

Alarm Number: Alarm Name	Possible Cause	Confirmation	Correction	Reference
A.042: Parameter Combination Error	The speed of program jog operation went below the setting range when the electronic gear ratio (Pn20E/Pn210) or the Servomotor was changed.	Check to see if the detection conditions* ¹ are satisfied.	Decrease the setting of the electronic gear ratio (Pn20E/Pn210).	page 5-42
	The speed of program jog operation went below the setting range when Pn533 or Pn585 (Program Jog Operation Speed) was changed.	Check to see if the detection conditions* ¹ are satisfied.	Increase the setting of Pn533 or Pn585.	page 7-13
	The movement speed of advanced autotuning went below the setting range when the electronic gear ratio (Pn20E/ Pn210) or the Servomotor was changed.	Check to see if the detection conditions* ² are satisfied.	Decrease the setting of the electronic gear ratio (Pn20E/Pn210).	page 5-42
A.044: Semi-Closed/ Fully-Closed Loop Control Parameter Setting Error	The setting of the Fully-closed Module does not match the setting of Pn002 = n.X□□□ (External Encoder Usage).	Check the setting of Pn002 = n.X□□□.	Make sure that the setting of the Fully-closed Module agrees with the setting of Pn002 = n.X□□□.	page 10-5
A.04A: Parameter Setting Error 2	A parameter reserved by the system was changed.	–	Set the following reserved parameters to the default settings. Pn200.2 Pn207.1 Pn50A.0 Pn50A.1 Pn50A.2 Pn50C Pn50D	–
A.050: Combination Error (The capacities of the SERVOPACK and Servomotor do not match.)	The SERVOPACK and Servomotor capacities do not match each other.	Confirm that the following condition is met: $1/4 \leq (\text{Servomotor capacity}/\text{SERVOPACK capacity}) \leq 4$	Select a proper combination of the SERVOPACK and Servomotor capacities.	page 1-16
	A failure occurred in the encoder.	Replace the encoder and check to see if the alarm still occurs.	Replace the Servomotor or encoder.	–
	A failure occurred in the SERVOPACK.	–	The SERVOPACK may be faulty. Replace the SERVOPACK.	–
A.051: Unsupported Device Alarm	The motor parameter file was not written to the linear encoder. (This applies only when not using a Serial Converter Unit.)	Check to see if the motor parameter file was written to the linear encoder.	Write the motor parameter file to the linear encoder.	page 5-17
	An unsupported Serial Converter Unit or encoder (e.g., an external encoder) is connected to the SERVOPACK.	Check the product combination specifications.	Change to a correct combination of models.	–

Continued on next page.

Continued from previous page.

Alarm Number: Alarm Name	Possible Cause	Confirmation	Correction	Reference
A.070: Motor Type Change Detected (The connected motor is a different type of motor from the previously connected motor.)	A Rotary Servomotor was removed and a Linear Servomotor was connected.	–	Set the parameters for a Linear Servomotor and reset the motor type alarm. Then, turn the power supply to the SERVOPACK OFF and ON again.	page 15-55
	A Linear Servomotor was removed and a Rotary Servomotor was connected.	–	Set the parameters for a Rotary Servomotor and reset the motor type alarm. Then, turn the power supply to the SERVOPACK OFF and ON again.	page 15-55
A.080: Linear Encoder Pitch Setting Error	The setting of Pn282 (Linear Encoder Pitch) has not been changed from the default setting.	Check the setting of Pn282.	Correct the setting of Pn282.	page 5-16
A.0b0: Invalid Servo ON Command Alarm	The /S-ON (Servo ON) signal was input from the host controller after a utility function that turns ON the Servomotor was executed.	–	Turn the power supply to the SERVOPACK OFF and ON again. Or, execute a software reset.	page 6-30

Continued on next page.

Continued from previous page.

Alarm Number: Alarm Name	Possible Cause	Confirmation	Correction	Reference
A.100: Overcurrent Detected (An overcurrent flowed through the power trans- former or the heat sink overheated.)	The Main Circuit Cable is not wired correctly or there is faulty contact.	Check the wiring.	Correct the wiring.	page 4-26
	There is a short-circuit or ground fault in a Main Circuit Cable.	Check for short-circuits across Servomotor phases U, V, and W, or between the ground and Servomotor phases U, V, and W.	The cable may be short-circuited. Replace the cable.	
	There is a short-circuit or ground fault inside the Servomotor.	Check for short-circuits across Servomotor phases U, V, and W, or between the ground and Servomotor phases U, V, or W.	The Servomotor may be faulty. Replace the Servomotor.	
	There is a short-circuit or ground fault inside the SERVOPACK.	Check for short-circuits across the Servomotor connection terminals U, V, and W on the SERVOPACK, or between the ground and terminals U, V, or W.	The SERVOPACK may be faulty. Replace the SERVOPACK.	
	The regenerative resistor is not wired correctly or there is faulty contact.	Check the wiring.	Correct the wiring.	page 4-23
	The dynamic brake (DB, emergency stop executed from the SERVOPACK) was frequently activated, or a DB overload alarm occurred.	Check the power consumed by the DB resistor to see how frequently the DB is being used. Or, check the alarm display to see if a DB overload alarm (A.730 or A.731) has occurred.	Change the SERVOPACK model, operating methods, or the mechanisms so that the dynamic brake does not need to be used so frequently.	—
	The regenerative processing capacity was exceeded.	Check the regenerative load ratio in the SigmaWin+ Motion Monitor Tab Page to see how frequently the regenerative resistor is being used.	Recheck the operating conditions and load.	*3
	The SERVOPACK regenerative resistance is too small.	Check the regenerative load ratio in the SigmaWin+ Motion Monitor Tab Page to see how frequently the regenerative resistor is being used.	Change the regenerative resistance to a value larger than the SERVOPACK minimum allowable resistance.	

Continued on next page.

Continued from previous page.

Alarm Number: Alarm Name	Possible Cause	Confirmation	Correction	Reference
A.100: Overcurrent Detected (An overcurrent flowed through the power trans- former or the heat sink overheated.)	A heavy load was applied while the Ser- vomotor was stopped or running at a low speed.	Check to see if the operating conditions exceed Servo Drive specifications.	Reduce the load applied to the Servomotor. Or, increase the operating speed.	–
	A malfunction was caused by noise.	Improve the noise envi- ronment, e.g. by improving the wiring or installation conditions, and check to see if the alarm still occurs.	Implement countermea- sures against noise, such as correct wiring of the FG. Use an FG wire size equivalent to the SERVO- PACK's main circuit wire size.	–
	A failure occurred in the SERVOPACK.	–	Turn the power supply to the SERVOPACK OFF and ON again. If an alarm still occurs, the SERVOPACK may be faulty. Replace the SERVOPACK.	–
A.101: Motor Overcur- rent Detected (The current to the motor exceeded the allowable cur- rent.)	The Main Circuit Cable is not wired correctly or there is faulty contact.	Check the wiring.	Correct the wiring.	page 4-26
	There is a short-circuit or ground fault in a Main Circuit Cable.	Check for short-circuits across cable phases U, V, and W, or between the ground and cable phases U, V, and W.	The cable may be short- circuited. Replace the cable.	
	There is a short-circuit or ground fault inside the Servomotor.	Check for short-circuits across Servomotor phases U, V, and W, or between the ground and Servomotor phases U, V, or W.	The Servomotor may be faulty. Replace the Servo- motor.	
	There is a short-circuit or ground fault inside the SERVOPACK.	Check for short-circuits across the Servomotor connection terminals U, V, and W on the SER- VOPACK, or between the ground and termi- nals U, V, or W.	The SERVOPACK may be faulty. Replace the SER- VOPACK.	
	A heavy load was applied while the Ser- vomotor was stopped or running at a low speed.	Check to see if the operating conditions exceed Servo Drive specifications.	Reduce the load applied to the Servomotor. Or, increase the operating speed.	–
	A malfunction was caused by noise.	Improve the noise envi- ronment, e.g. by improving the wiring or installation conditions, and check to see if the alarm still occurs.	Implement countermea- sures against noise, such as correct wiring of the FG. Use an FG wire size equivalent to the SERVO- PACK's main circuit wire size.	–
	A failure occurred in the SERVOPACK.	–	Turn the power supply to the SERVOPACK OFF and ON again. If an alarm still occurs, the SERVOPACK may be faulty. Replace the SERVOPACK.	–

Continued on next page.

Continued from previous page.

Alarm Number: Alarm Name	Possible Cause	Confirmation	Correction	Reference
A.300: Regeneration Error	When using the built-in regenerative resistor, the jumper between the regenerative resistor terminals (B2 and B3) was removed from one of the following SERVOPACKs: SGD7S-3R8A, -5R5A, -7R6A, -120A, -180A, -200A, or -330A.	Check to see if the jumper is connected between power supply terminals B2 and B3.*4	Correctly connect a jumper.	page 4-23
	The External Regenerative Resistor or Regenerative Resistor Unit is not wired correctly, or was removed or disconnected.	Check the wiring of the External Regenerative Resistor or Regenerative Resistor Unit.*4	Correct the wiring of the External Regenerative Resistor or Regenerative Resistor Unit.	
	Pn600 (Regenerative Resistor Capacity) is not set to 0 and an External Regenerative Resistor is not connected to one of the following SERVOPACKs: SGD7S-R70A, -R90A, -1R6A, -2R8A, -R70F, -R90F, -2R1F, or -2R8F.	Check to see if an External Regenerative Resistor is connected and check the setting of Pn600.	Connect an External Regenerative Resistor, or set Pn600 (Regenerative Resistor Capacity) to 0 (setting unit: $\times 10$ W) if no Regenerative Resistor is required.	page 5-54
	A Regenerative Resistor is not connected to one of the following SERVOPACKs: SGD7S-470A, -550A, -590A, or -780A.	Check to see if an External Regenerative Resistor or a Regenerative Resistor Unit is connected and check the setting of Pn600.	Connect an External Regenerative Resistor and set Pn600 to an appropriate value, or connect a Regenerative Resistor Unit and set Pn600 to 0.	
	A failure occurred in the SERVOPACK.	–	While the main circuit power supply is OFF, turn the control power supply to the SERVOPACK OFF and ON again. If an alarm still occurs, the SERVOPACK may be faulty. Replace the SERVOPACK.	–

Continued on next page.

Continued from previous page.

Alarm Number: Alarm Name	Possible Cause	Confirmation	Correction	Reference
A.320: Regenerative Overload	The power supply voltage exceeded the specified range.	Measure the power supply voltage.	Set the power supply voltage within the specified range.	–
	The external regenerative resistance value or regenerative resistor capacity is too small, or there has been a continuous regeneration state.	Check the operating conditions or the capacity using the SigmaJunmaSize+ Capacity Selection Software or other means.	Change the regenerative resistance value or capacity. Reconsider the operating conditions using the SigmaJunmaSize+ Capacity Selection Software or other means.	*3
	There was a continuous regeneration state because a negative load was continuously applied.	Check the load applied to the Servomotor during operation.	Reconsider the system including the servo, machine, and operating conditions.	–
	The setting of Pn600 (Regenerative Resistor Capacity) is smaller than the capacity of the External Regenerative Resistor.	Check to see if a Regenerative Resistor is connected and check the setting of Pn600.	Correct the setting of Pn600.	page 5-54
	The setting of Pn603 (Regenerative Resistor Capacity) is smaller than the capacity of the External Regenerative Resistor.	Check to see if a Regenerative Resistor is connected and check the setting of Pn603.	Correct the setting of Pn603.	page 5-54
	The external regenerative resistance is too high.	Check the regenerative resistance.	Change the regenerative resistance to a correct value or use an External Regenerative Resistor of an appropriate capacity.	*3
	A failure occurred in the SERVOPACK.	–	The SERVOPACK may be faulty. Replace the SERVOPACK.	–

Continued on next page.

Continued from previous page.

Alarm Number: Alarm Name	Possible Cause	Confirmation	Correction	Reference
A.330: Main Circuit Power Supply Wiring Error (Detected when the main circuit power supply is turned ON.)	The regenerative resistor was disconnected when the SERVOPACK power supply voltage was high.	Measure the resistance of the regenerative resistor using a measuring instrument.	If you are using the regenerative resistor built into the SERVOPACK, replace the SERVOPACK. If you are using an External Regenerative Resistor, replace the External Regenerative Resistor.	–
	DC power was supplied when an AC power supply input was specified in the settings.	Check the power supply to see if it is a DC power supply.	Correct the power supply setting to match the actual power supply.	page 5-12
	AC power was supplied when a DC power supply input was specified in the settings.	Check the power supply to see if it is an AC power supply.	Correct the power supply setting to match the actual power supply.	
	Pn600 (Regenerative Resistor Capacity) is not set to 0 and an External Regenerative Resistor is not connected to one of the following SERVOPACKs: SGD7S-R70A, -R90A, -1R6A, -2R8A, -R70F, -R90F, -2R1F, or -2R8F.	Check to see if an External Regenerative Resistor is connected and check the setting of Pn600.	Connect an External Regenerative Resistor, or if an External Regenerative Resistor is not required, set Pn600 to 0.	page 4-23, page 5-54
	A failure occurred in the SERVOPACK.	–	The SERVOPACK may be faulty. Replace the SERVOPACK.	–

Continued on next page.

Continued from previous page.

Alarm Number: Alarm Name	Possible Cause	Confirmation	Correction	Reference
A.400: Overvoltage (Detected in the main circuit power supply section of the SERVOPACK.)	The power supply voltage exceeded the specified range.	Measure the power supply voltage.	Set the AC/DC power supply voltage within the specified range.	–
	The power supply is not stable or was influenced by a lightning surge.	Measure the power supply voltage.	Improve the power supply conditions, install a surge absorber, and then turn the power supply OFF and ON again. If an alarm still occurs, the SERVOPACK may be faulty. Replace the SERVOPACK.	–
	The voltage for AC power supply was too high during acceleration or deceleration.	Check the power supply voltage and the speed and torque during operation.	Set the AC power supply voltage within the specified range.	–
	The external regenerative resistance is too high for the operating conditions.	Check the operating conditions and the regenerative resistance.	Select a regenerative resistance value that is appropriate for the operating conditions and load.	*3
	The moment of inertia ratio or mass ratio exceeded the allowable value.	Check to see if the moment of inertia ratio or mass ratio is within the allowable range.	Increase the deceleration time, or reduce the load.	–
	A failure occurred in the SERVOPACK.	–	While the main circuit power supply is OFF, turn the control power supply to the SERVOPACK OFF and ON again. If an alarm still occurs, the SERVOPACK may be faulty. Replace the SERVOPACK.	–

Continued on next page.

Continued from previous page.

Alarm Number: Alarm Name	Possible Cause	Confirmation	Correction	Reference
A.410: Undervoltage (Detected in the main circuit power supply section of the SERVOPACK.)	The power supply voltage went below the specified range.	Measure the power supply voltage.	Set the power supply voltage within the specified range.	–
	The power supply voltage dropped during operation.	Measure the power supply voltage.	Increase the power supply capacity.	–
	A momentary power interruption occurred.	Measure the power supply voltage.	If you have changed the setting of Pn509 (Momentary Power Interruption Hold Time), decrease the setting.	page 6-11
	The SERVOPACK fuse is blown out.	Check the power supply wiring.	Correct the power supply wiring and replace the SERVOPACK.	page 4-17
	The SERVOPACK fuse is blown out.	–	Replace the SERVOPACK and connect a reactor to the DC reactor terminals (⊖1 and ⊖2) on the SERVOPACK.	–
	A failure occurred in the SERVOPACK.	–	The SERVOPACK may be faulty. Replace the SERVOPACK.	–
	The jumper between the DC Reactor terminals (⊖1 and ⊖2) was removed or there is faulty contact.	–	Correct the wiring between the DC Reactor terminals.	–
The cable between the DC Reactor and SERVOPACK is not wired correctly or there is a faulty contact.				
A.510: Overspeed (The motor exceeded the maximum speed.)	The order of phases U, V, and W in the motor wiring is not correct.	Check the wiring of the Servomotor.	Make sure that the Servomotor is correctly wired.	–
	A reference value that exceeded the overspeed detection level was input.	Check the input reference.	Reduce the reference value. Or, adjust the gain.	–
	The motor exceeded the maximum speed.	Check the waveform of the motor speed.	Adjust the servo gains. Or, reconsider the operating conditions.	–
	A failure occurred in the SERVOPACK.	–	The SERVOPACK may be faulty. Replace the SERVOPACK.	–
A.511: Encoder Output Pulse Overspeed	The encoder output pulse frequency exceeded the limit.	Check the encoder output pulse setting.	Decrease the setting of Pn212 (Encoder Output Pulses) or Pn281 (Encoder Output Resolution).	page 6-20
	The encoder output pulse frequency exceeded the limit because the motor speed was too high.	Check the encoder output pulse setting and the motor speed.	Reduce the motor speed.	–

Continued on next page.

Continued from previous page.

Alarm Number: Alarm Name	Possible Cause	Confirmation	Correction	Reference
A.520: Vibration Alarm	Abnormal oscillation was detected in the motor speed.	Check for abnormal motor noise, and check the speed and torque waveforms during operation.	Reduce the motor speed. Or, reduce the setting of Pn100 (Speed Loop Gain).	page 8-73
	The setting of Pn103 (Moment of Inertia Ratio) is greater than the actual moment of inertia or was greatly changed.	Check the moment of inertia ratio or mass ratio.	Set Pn103 (Moment of Inertia Ratio) to an appropriate value.	page 8-15
	The vibration detection level (Pn312 or Pn384) is not suitable.	Check that the vibration detection level (Pn312 or Pn384) is suitable.	Set a suitable vibration detection level (Pn312 or Pn384).	page 6-32
A.521: Autotuning Alarm (Vibration was detected while executing the custom tuning, Easy FFT, or the tuning-less function.)	The Servomotor vibrated considerably while performing the tuning-less function.	Check the waveform of the motor speed.	Reduce the load so that the moment of inertia ratio is within the allowable value. Or increase the load level or reduce the rigidity level in the tuning-less level settings.	page 8-12
	The Servomotor vibrated considerably while performing custom tuning or Easy FFT.	Check the waveform of the motor speed.	Check the operating procedure of corresponding function and implement corrections.	page 8-41, page 8-89
A.550: Maximum Speed Setting Error	The setting of Pn385 (Maximum Motor Speed) is greater than the maximum speed.	Check the setting of Pn385, and the upper limits of the maximum motor speed setting and the encoder output resolution setting.	Set Pn385 to a value that does not exceed the maximum motor speed.	page 6-14

Continued on next page.

Continued from previous page.

Alarm Number: Alarm Name	Possible Cause	Confirmation	Correction	Reference
A.710: Instantaneous Overload A.720: Continuous Overload	The wiring is not correct or there is a faulty connection in the motor or encoder wiring.	Check the wiring.	Make sure that the Servomotor and encoder are correctly wired.	page 4-26
	Operation was performed that exceeded the overload protection characteristics.	Check the motor overload characteristics and Run command.	Reconsider the load and operating conditions. Or, increase the motor capacity.	–
	An excessive load was applied during operation because the Servomotor was not driven due to mechanical problems.	Check the operation reference and motor speed.	Correct the mechanical problem.	–
	Operation was performed with a load applied to the shaft of the servomotor that exceeded the allowable value.	Check the condition of the machine to determine if a load was applied to the shaft of the servomotor that exceeded the allowable value.	Correct the condition of the machine so that the load on the shaft during servomotor operation does not exceed the allowable value.	–
	There is an error in the setting of Pn282 (Linear Encoder Pitch).	Check the setting of Pn282.	Correct the setting of Pn282.	page 5-16
	There is an error in the setting of Pn080 = n.□□X□ (Motor Phase Selection).	Check the setting of Pn080 = n.□□X□.	Set Pn080 = n.□□X□ to an appropriate value.	page 5-21
	A failure occurred in the SERVOPACK.	–	The SERVOPACK may be faulty. Replace the SERVOPACK.	–
A.730 and A.731: Dynamic Brake Overload (An excessive power consumption by the dynamic brake was detected.)	The Servomotor was rotated by an external force.	Check the operation status.	Implement measures to ensure that the motor will not be rotated by an external force.	–
	When the Servomotor was stopped with the dynamic brake, the rotational or linear kinetic energy exceeded the capacity of the dynamic brake resistor.	Check the power consumed by the DB resistor to see how frequently the DB is being used.	Reconsider the following: <ul style="list-style-type: none"> • Reduce the Servomotor command speed. • Decrease the moment of inertia ratio or mass ratio. • Reduce the frequency of stopping with the dynamic brake. 	–
	A failure occurred in the SERVOPACK.	–	The SERVOPACK may be faulty. Replace the SERVOPACK.	–
A.740: Inrush Current Limiting Resistor Overload (The main circuit power supply was frequently turned ON and OFF.)	The allowable frequency of the inrush current limiting resistor was exceeded when the main circuit power supply was turned ON and OFF.	–	Reduce the frequency of turning the main circuit power supply ON and OFF.	–
	A failure occurred in the SERVOPACK.	–	The SERVOPACK may be faulty. Replace the SERVOPACK.	–

Continued on next page.

Continued from previous page.

Alarm Number: Alarm Name	Possible Cause	Confirmation	Correction	Reference
A.7A1: Internal Temperature Error 1 (Control Board Temperature Error)	The surrounding temperature is too high.	Check the surrounding temperature using a thermometer. Or, check the operating status with the SERVOPACK installation environment monitor.	Decrease the surrounding temperature by improving the SERVOPACK installation conditions.	page 3-8
	An overload alarm was reset by turning OFF the power supply too many times.	Check the alarm display to see if there is an overload alarm.	Change the method for resetting the alarm.	–
	There was an excessive load or operation was performed that exceeded the regenerative processing capacity.	Use the accumulated load ratio to check the load during operation, and use the regenerative load ratio to check the regenerative processing capacity.	Reconsider the load and operating conditions.	–
	The SERVOPACK installation orientation is not correct or there is insufficient space around the SERVOPACK.	Check the SERVOPACK installation conditions.	Install the SERVOPACK according to specifications.	page 3-4, page 3-7
	A failure occurred in the SERVOPACK.	–	The SERVOPACK may be faulty. Replace the SERVOPACK.	–
A.7A2: Internal Temperature Error 2 (Power Board Temperature Error)	The surrounding temperature is too high.	Check the surrounding temperature using a thermometer. Or, check the operating status with the SERVOPACK installation environment monitor.	Decrease the surrounding temperature by improving the SERVOPACK installation conditions.	page 3-8
	An overload alarm was reset by turning OFF the power supply too many times.	Check the alarm display to see if there is an overload alarm.	Change the method for resetting the alarm.	–
	There was an excessive load or operation was performed that exceeded the regenerative processing capacity.	Use the accumulated load ratio to check the load during operation, and use the regenerative load ratio to check the regenerative processing capacity.	Reconsider the load and operating conditions.	–
	The SERVOPACK installation orientation is not correct or there is insufficient space around the SERVOPACK.	Check the SERVOPACK installation conditions.	Install the SERVOPACK according to specifications.	page 3-4, page 3-7
	A failure occurred in the SERVOPACK.	–	The SERVOPACK may be faulty. Replace the SERVOPACK.	–
A.7A3: Internal Temperature Sensor Error (An error occurred in the temperature sensor circuit.)	A failure occurred in the SERVOPACK.	–	The SERVOPACK may be faulty. Replace the SERVOPACK.	–

Continued on next page.

Continued from previous page.

Alarm Number: Alarm Name	Possible Cause	Confirmation	Correction	Reference
A.7Ab: SERVOPACK Built-in Fan Stopped	The fan inside the SERVOPACK stopped.	Check for foreign matter inside the SERVOPACK.	Remove foreign matter from the SERVOPACK. If an alarm still occurs, the SERVOPACK may be faulty. Replace the SERVOPACK.	–
A.810: Encoder Backup Alarm (Detected at the encoder, but only when an absolute encoder is used.)	The power to the absolute encoder was turned ON for the first time.	Check to see if the power supply was turned ON for the first time.	Set up the encoder.	page 5-48
	The Encoder Cable was disconnected and then connected again.	Check to see if the power supply was turned ON for the first time.	Check the encoder connection and set up the encoder.	
	Power is not being supplied both from the control power supply (+5 V) from the SERVOPACK and from the battery power supply.	Check the encoder connector battery and the connector status.	Replace the battery or implement similar measures to supply power to the encoder, and set up the encoder.	–
	A failure occurred in the absolute encoder.	–	If the alarm still occurs after setting up the encoder again, replace the Servomotor.	–
A.820: Encoder Checksum Alarm (Detected at the encoder.)	A failure occurred in the encoder.	–	<ul style="list-style-type: none"> ■ When Using an Absolute Encoder Set up the encoder again. If the alarm still occurs, the Servomotor may be faulty. Replace the Servomotor. ■ When Using a Single-turn Absolute Encoder or Incremental Encoder <ul style="list-style-type: none"> • The Servomotor may be faulty. Replace the Servomotor. • The linear encoder may be faulty. Replace the linear encoder. 	page 5-48
	A failure occurred in the SERVOPACK.	–	The SERVOPACK may be faulty. Replace the SERVOPACK.	–
A.830: Encoder Battery Alarm (The absolute encoder battery voltage was lower than the specified level.)	The battery connection is faulty or a battery is not connected.	Check the battery connection.	Correct the battery connection.	page 4-27
	The battery voltage is lower than the specified value (2.7 V).	Measure the battery voltage.	Replace the battery.	page 15-3
	A failure occurred in the SERVOPACK.	–	The SERVOPACK may be faulty. Replace the SERVOPACK.	–

Continued on next page.

Continued from previous page.

Alarm Number: Alarm Name	Possible Cause	Confirmation	Correction	Reference
A.840: Encoder Data Alarm (Detected at the encoder.)	The encoder malfunctioned.	–	Turn the power supply to the SERVOPACK OFF and ON again. If an alarm still occurs, the Servomotor or linear encoder may be faulty. Replace the Servomotor or linear encoder.	–
	An error occurred in reading data from the linear encoder.	–	The linear encoder is not mounted within an appropriate tolerance. Correct the mounting of the linear encoder.	–
	Excessive speed occurred in the linear encoder.	–	Control the motor speed within the range specified by the linear encoder manufacturer and then turn ON the control power supply.	–
	The encoder malfunctioned due to noise.	–	Correct the wiring around the encoder by separating the Encoder Cable from the Servomotor Main Circuit Cable or by grounding the encoder.	–
	The polarity sensor is not wired correctly.	Check the wiring of the polarity sensor.	Correct the wiring of the polarity sensor.	–
	The polarity sensor failed.	–	Replace the polarity sensor.	–
A.850: Encoder Over-speed (Detected at the encoder when the control power supply is turned ON.)	Rotary Servomotor: The Servomotor speed was 200 min ⁻¹ or higher when the control power supply was turned ON.	Check the motor speed when the power supply is turned ON.	Reduce the Servomotor speed to a value less than 200 min ⁻¹ , and turn ON the control power supply.	–
	Linear Servomotor: The Servomotor exceeded the specified speed when the control power supply was turned ON.	Check the motor speed when the power supply is turned ON.	Control the motor speed within the range specified by the linear encoder manufacturer and then turn ON the control power supply.	–
	A failure occurred in the encoder.	–	Turn the power supply to the SERVOPACK OFF and ON again. If an alarm still occurs, the Servomotor or linear encoder may be faulty. Replace the Servomotor or linear encoder.	–
	A failure occurred in the SERVOPACK.	–	Turn the power supply to the SERVOPACK OFF and ON again. If an alarm still occurs, the SERVOPACK may be faulty. Replace the SERVOPACK.	–

Continued on next page.

Continued from previous page.

Alarm Number: Alarm Name	Possible Cause	Confirmation	Correction	Reference
A.860: Encoder Overheated (Detected when a Rotary Servomotor, Absolute Linear Encoder, or Direct Drive Servomotor is connected. However, this alarm is not detected for SGMCS Servomotors.) (Detected at the encoder.)	The surrounding air temperature around the Servomotor is too high.	Measure the surrounding air temperature around the Servomotor.	Reduce the surrounding air temperature of the Servomotor to 40°C or less.	–
	The Servomotor load is greater than the rated load.	Use the accumulated load ratio to check the load.	Operate the Servo Drive so that the motor load remains within the specified range.	page 9-3
	A failure occurred in the encoder.	–	Turn the power supply to the SERVOPACK OFF and ON again. If an alarm still occurs, the Servomotor or absolute linear encoder may be faulty. Replace the Servomotor or absolute linear encoder.	–
	A failure occurred in the SERVOPACK.	–	Turn the power supply to the SERVOPACK OFF and ON again. If an alarm still occurs, the SERVOPACK may be faulty. Replace the SERVOPACK.	–
A.861: Motor Overheated	The surrounding temperature around the Servomotor is too high.	Measure the surrounding temperature around the Servomotor.	Reduce the surrounding air temperature of the Servomotor to 40° or less.	–
	The motor load is greater than the rated load.	Check the load with the accumulated load ratio on the Motion Monitor Tab Page on the SigmaWin+.	Operate the Servo Drive so that the motor load remains within the specified range.	page 9-3
	A failure occurred in the Serial Converter Unit.	–	Turn the power supply to the SERVOPACK OFF and ON again. If an alarm still occurs, the Serial Converter Unit may be faulty. Replace the Serial Converter Unit.	–
	A failure occurred in the SERVOPACK.	–	Turn the power supply to the SERVOPACK OFF and ON again. If an alarm still occurs, the SERVOPACK may be faulty. Replace the SERVOPACK.	–

Continued on next page.

Continued from previous page.

Alarm Number: Alarm Name	Possible Cause	Confirmation	Correction	Reference
A.862: Overheat Alarm	The surrounding temperature is too high.	Check the surrounding temperature using a thermometer.	Lower the surrounding temperature by improving the installation conditions of the Linear Servomotor or the machine.	–
	The overheat protection input signal line is disconnected or short-circuited.	Check the input voltage with the overheat protection input information on the Motion Monitor Tab Page on the SigmaWin+.	Repair the line for the overheat protection input signal.	–
	An overload alarm was reset by turning OFF the power supply too many times.	Check the alarm display to see if there is an overload alarm.	Change the method for resetting the alarm.	–
	Operation was performed under an excessive load.	Use the accumulated load ratio to check the load during operation.	Reconsider the load and operating conditions.	–
	A failure occurred in the SERVOPACK.	–	The SERVOPACK may be faulty. Replace the SERVOPACK.	–
	The temperature detection circuit in the Linear Servomotor is faulty or the sensor attached to the machine is faulty.	–	The temperature detection circuit in the Linear Servomotor may be faulty or the sensor attached to the machine may be faulty. Replace the Linear Servomotor or repair the sensor attached to the machine.	–
A.890: Encoder Scale Error	A failure occurred in the linear encoder.	–	The linear encoder may be faulty. Replace the linear encoder.	–
A.891: Encoder Module Error	A failure occurred in the linear encoder.	–	Turn the power supply to the SERVOPACK OFF and ON again. If an alarm still occurs, the linear encoder may be faulty. Replace the linear encoder.	–
A.8A0: External Encoder Error	Setting the origin of the absolute linear encoder failed because the motor moved.	Before you set the origin, use the fully-closed feedback pulse counter to confirm that the motor is not moving.	The motor must be stopped while setting the origin position.	page 5-51
	A failure occurred in the external encoder.	–	Replace the external encoder.	–
A.8A1: External Encoder Module Error	A failure occurred in the external encoder.	–	Replace the external encoder.	–
	A failure occurred in the Serial Converter Unit.	–	Replace the Serial Converter Unit.	–
A.8A2: External Incremental Encoder Sensor Error	A failure occurred in the external encoder.	–	Replace the external encoder.	–
A.8A3: External Absolute Encoder Position Error	A failure occurred in the external absolute encoder.	–	The external absolute encoder may be faulty. Refer to the encoder manufacturer's instruction manual for corrections.	–

Continued on next page.

Continued from previous page.

Alarm Number: Alarm Name	Possible Cause	Confirmation	Correction	Reference
A.8A5: External Encoder Overspeed	An overspeed error was detected in the external encoder.	Check the maximum speed of the external encoder.	Keep the external encoder below its maximum speed.	–
A.8A6: External Encoder Overheated	An overheating error was detected in the external encoder.	–	Replace the external encoder.	–
A.AEF: INDEXER Module Alarm	Some kind of alarm has occurred at the INDEXER Module.	Use the SigmaWin+ to check the serial command negative response of the INDEXER Module.	Follow the correction for a serial command negative response from the INDEXER Module.	page 15-46
A.b33: Current Detection Error 3	A failure occurred in the current detection circuit.	–	Turn the power supply to the SERVOPACK OFF and ON again. If an alarm still occurs, the SERVOPACK may be faulty. Replace the SERVOPACK.	–
A.bC0: System Alarm 10	A failure occurred in the SERVOPACK.	–	Turn the power supply to the SERVOPACK OFF and ON again. If an alarm still occurs, the SERVOPACK may be faulty. Replace the SERVOPACK.	–
A.bF0: System Alarm 0	A failure occurred in the SERVOPACK.	–	Turn the power supply to the SERVOPACK OFF and ON again. If an alarm still occurs, the SERVOPACK may be faulty. Replace the SERVOPACK.	–
A.bF1: System Alarm 1	A failure occurred in the SERVOPACK.	–	Turn the power supply to the SERVOPACK OFF and ON again. If an alarm still occurs, the SERVOPACK may be faulty. Replace the SERVOPACK.	–
A.bF2: System Alarm 2	A failure occurred in the SERVOPACK.	–	Turn the power supply to the SERVOPACK OFF and ON again. If an alarm still occurs, the SERVOPACK may be faulty. Replace the SERVOPACK.	–
A.bF3: System Alarm 3	A failure occurred in the SERVOPACK.	–	Turn the power supply to the SERVOPACK OFF and ON again. If an alarm still occurs, the SERVOPACK may be faulty. Replace the SERVOPACK.	–
A.bF4: System Alarm 4	A failure occurred in the SERVOPACK.	–	Turn the power supply to the SERVOPACK OFF and ON again. If an alarm still occurs, the SERVOPACK may be faulty. Replace the SERVOPACK.	–
A.bF5: System Alarm 5	A failure occurred in the SERVOPACK.	–	Turn the power supply to the SERVOPACK OFF and ON again. If an alarm still occurs, the SERVOPACK may be faulty. Replace the SERVOPACK.	–

Continued on next page.

Continued from previous page.

Alarm Number: Alarm Name	Possible Cause	Confirmation	Correction	Reference
A.bF6: System Alarm 6	A failure occurred in the SERVOPACK.	—	Turn the power supply to the SERVOPACK OFF and ON again. If an alarm still occurs, the SERVOPACK may be faulty. Replace the SERVOPACK.	—
A.bF7: System Alarm 7	A failure occurred in the SERVOPACK.	—	Turn the power supply to the SERVOPACK OFF and ON again. If an alarm still occurs, the SERVOPACK may be faulty. Replace the SERVOPACK.	—
A.bF8: System Alarm 8	A failure occurred in the SERVOPACK.	—	Turn the power supply to the SERVOPACK OFF and ON again. If an alarm still occurs, the SERVOPACK may be faulty. Replace the SERVOPACK.	—
A.C10: Servomotor Out of Control (Detected when the servo is turned ON.)	The order of phases U, V, and W in the motor wiring is not correct.	Check the Servomotor wiring.	Make sure that the Servomotor is correctly wired.	—
	There is an error in the setting of Pn080 = n.□□X□ (Motor Phase Selection).	Check the setting of Pn080 = n.□□X□.	Set Pn080 = n.□□X□ to an appropriate value.	page 5-21
	A failure occurred in the encoder.	—	If the motor wiring is correct and an alarm still occurs after turning the power supply OFF and ON again, the Servomotor or linear encoder may be faulty. Replace the Servomotor or linear encoder.	—
	A failure occurred in the SERVOPACK.	—	Turn the power supply to the SERVOPACK OFF and ON again. If an alarm still occurs, the SERVOPACK may be faulty. Replace the SERVOPACK.	—
A.C20: Phase Detection Error	The linear encoder signal level is too low.	Check the voltage of the linear encoder signal.	Fine-tune the mounting of the scale head. Or, replace the linear encoder.	—
	The count-up direction of the linear encoder does not match the forward direction of the Moving Coil in the motor.	Check the setting of Pn080 = n.□□X□ (Motor Phase Selection). Check the installation orientation for the linear encoder and Moving Coil.	Change the setting of Pn080 = n.□□X□. Correctly reinstall the linear encoder or Moving Coil.	page 5-21
	The polarity sensor signal is being affected by noise.	—	Correct the FG wiring. Implement countermeasures against noise for the polarity sensor wiring.	—
	The setting of Pn282 (Linear Encoder Scale Pitch) is not correct.	Check the setting of Pn282 (Linear Encoder Scale Pitch).	Check the specifications of the linear encoder and set a correct value.	page 5-16

Continued on next page.

Continued from previous page.

Alarm Number: Alarm Name	Possible Cause	Confirmation	Correction	Reference
A.C21: Polarity Sensor Error	The polarity sensor is protruding from the Magnetic Way of the motor.	Check the polarity sensor.	Correctly reinstall the Moving Coil or Magnetic Way of the motor.	–
	The polarity sensor is not wired correctly.	Check the wiring of the polarity sensor.	Correct the wiring of the polarity sensor.	–
	The polarity sensor failed.	–	Replace the polarity sensor.	–
A.C22: Phase Information Disagreement	The SERVOPACK phase information is different from the linear encoder phase information.	–	Perform polarity detection.	page 5-26

Continued on next page.

Continued from previous page.

Alarm Number: Alarm Name	Possible Cause	Confirmation	Correction	Reference
A.C50: Polarity Detection Failure	The parameter settings are not correct.	Check the linear encoder specifications and feedback signal status.	The settings of Pn282 (Linear Encoder Pitch) and Pn080 = n.□□X□ (Motor Phase Selection) may not match the installation. Set the parameters to correct values.	page 5-16, page 5-21
	There is noise on the scale signal.	Check to make sure that the frame grounds of the Serial Converter Unit and Servomotor are connected to the FG terminal on the SERVOPACK and that the FG terminal on the SERVOPACK is connected to the frame ground on the power supply. And, confirm that the shield is properly processed on the Linear Encoder Cable. Check to see if the detection reference is repeatedly output in one direction.	Implement appropriate countermeasures against noise for the Linear Encoder Cable.	-
	An external force was applied to the Moving Coil of the motor.	-	The polarity cannot be properly detected if the detection reference is 0 and the speed feedback is not 0 because of an external force, such as cable tension, applied to the Moving Coil. Implement measures to reduce the external force so that the speed feedback goes to 0. If the external force cannot be reduced, increase the setting of Pn481 (Polarity Detection Speed Loop Gain).	-
	The linear encoder resolution is too low.	Check the linear encoder scale pitch to see if it is within 100 μm.	If the linear encoder scale pitch is 100 μm or higher, the SERVOPACK cannot detect the correct speed feedback. Use a linear encoder scale pitch with higher resolution. (We recommend a pitch of 40 μm or less.) Or, increase the setting of Pn485 (Polarity Detection Reference Speed). However, increasing the setting of Pn485 will increase the Servomotor movement range that is required for polarity detection.	-
A.C51: Overtravel Detected during Polarity Detection	The overtravel signal was detected during polarity detection.	Check the overtravel position.	Wire the overtravel signals. Execute polarity detection at a position where an overtravel signal would not be detected.	page 4-38

Continued on next page.

Continued from previous page.

Alarm Number: Alarm Name	Possible Cause	Confirmation	Correction	Reference
A.C52: Polarity Detection Not Completed	The servo was turned ON under the following circumstances. <ul style="list-style-type: none"> When an absolute scale was in use When polarity detection was not completed 	–	Execute polarity detection (with the SigmaWin+ or Digital Operator, Fn080).	–
A.C53: Out of Range of Motion for Polarity Detection	The travel distance exceeded the setting of Pn48E (Polarity Detection Range) in the middle of detection.	–	Increase the setting of Pn48E (Polarity Detection Range). Or, increase the setting of Pn481 (Polarity Detection Speed Loop Gain).	–
A.C54: Polarity Detection Failure 2	An external force was applied to the Servomotor.	–	Increase the setting of Pn495 (Polarity Detection Confirmation Force Reference). Increase the setting of Pn498 (Polarity Detection Allowable Error Range). Increasing the allowable error will also increase the motor temperature.	–
A.C80: Encoder Clear Error or Multiturn Limit Setting Error	A failure occurred in the encoder.	–	Turn the power supply to the SERVOPACK OFF and ON again. If an alarm still occurs, the Servomotor or linear encoder may be faulty. Replace the Servomotor or linear encoder.	–
	A failure occurred in the SERVOPACK.	–	Turn the power supply to the SERVOPACK OFF and ON again. If an alarm still occurs, the SERVOPACK may be faulty. Replace the SERVOPACK.	–

Continued on next page.

Continued from previous page.

Alarm Number: Alarm Name	Possible Cause	Confirmation	Correction	Reference
A.C90: Encoder Commu- nications Error	There is a faulty contact in the connector or the connector is not wired correctly for the encoder.	Check the condition of the encoder connector.	Reconnect the encoder connector and check the encoder wiring.	page 4-26
	There is a cable disconnection or short-circuit in the encoder. Or, the cable impedance is outside the specified values.	Check the condition of the Encoder Cable.	Use the Encoder Cable within the specified specifications.	–
	One of the following has occurred: corrosion caused by improper temperature, humidity, or gas, a short-circuit caused by entry of water drops or cutting oil, or faulty contact in connector caused by vibration.	Check the operating environment.	Improve the operating environment, and replace the cable. If the alarm still occurs, replace the SERVOPACK.	page 3-2
	A malfunction was caused by noise.	–	Correct the wiring around the encoder by separating the Encoder Cable from the Servomotor Main Circuit Cable or by grounding the encoder.	page 4-6
	A failure occurred in the SERVOPACK.	–	Connect the Servomotor to another SERVOPACK, and turn ON the control power supply. If no alarm occurs, the SERVOPACK may be faulty. Replace the SERVOPACK.	–
	A failure occurred in the encoder.	–	Connect the Servomotor to another SERVOPACK, and turn ON the control power supply. If the alarm occurs, the Servomotor may be faulty. Replace the Servomotor.	–
A.C91: Encoder Commu- nications Position Data Acceleration Rate Error	Noise entered on the signal lines because the Encoder Cable is bent or the sheath is damaged.	Check the condition of the Encoder Cable and connectors.	Check the Encoder Cable to see if it is installed correctly.	page 4-9
	The Encoder Cable is bundled with a high-current line or installed near a high-current line.	Check the installation condition of the Encoder Cable.	Confirm that there is no surge voltage on the Encoder Cable.	–
	There is variation in the FG potential because of the influence of machines on the Servomotor side, such as a welder.	Check the installation condition of the Encoder Cable.	Properly ground the machine to separate it from the FG of the encoder.	–

Continued on next page.

Continued from previous page.

Alarm Number: Alarm Name	Possible Cause	Confirmation	Correction	Reference
A.C92: Encoder Commu- nications Timer Error	Noise entered on the signal line from the encoder.	–	Implement countermeasures against noise for the encoder wiring.	page 4-6
	Excessive vibration or shock was applied to the encoder.	Check the operating conditions.	Reduce machine vibration. Correctly install the Servomotor or linear encoder.	–
	A failure occurred in the encoder.	–	Turn the power supply to the SERVOPACK OFF and ON again. If an alarm still occurs, the Servomotor or linear encoder may be faulty. Replace the Servomotor or linear encoder.	–
	A failure occurred in the SERVOPACK.	–	Turn the power supply to the SERVOPACK OFF and ON again. If an alarm still occurs, the SERVOPACK may be faulty. Replace the SERVOPACK.	–
A.CA0: Encoder Parame- ter Error	A failure occurred in the encoder.	–	Turn the power supply to the SERVOPACK OFF and ON again. If an alarm still occurs, the Servomotor or linear encoder may be faulty. Replace the Servomotor or linear encoder.	–
	A failure occurred in the SERVOPACK.	–	Turn the power supply to the SERVOPACK OFF and ON again. If an alarm still occurs, the SERVOPACK may be faulty. Replace the SERVOPACK.	–

Continued on next page.

Continued from previous page.

Alarm Number: Alarm Name	Possible Cause	Confirmation	Correction	Reference
A.Cb0: Encoder Echo-back Error	The encoder is wired incorrectly or there is faulty contact.	Check the wiring of the encoder.	Make sure that the encoder is correctly wired.	page 4-26
	The specifications of the Encoder Cable are not correct and noise entered on it.	–	Use a shielded twisted-pair wire cable or a screened twisted-pair cable with conductors of at least 0.12 mm ² .	–
	The Encoder Cable is too long and noise entered on it.	–	<ul style="list-style-type: none"> Rotary Servomotors: The Encoder Cable wiring distance must be 50 m max. Linear Servomotors: The Encoder Cable wiring distance must be 20 m max. 	–
	There is variation in the FG potential because of the influence of machines on the Servomotor side, such as a welder.	Check the condition of the Encoder Cable and connectors.	Properly ground the machine to separate it from the FG of the encoder.	–
	Excessive vibration or shock was applied to the encoder.	Check the operating conditions.	Reduce machine vibration. Correctly install the Servomotor or linear encoder.	–
	A failure occurred in the encoder.	–	Turn the power supply to the SERVOPACK OFF and ON again. If an alarm still occurs, the Servomotor or linear encoder may be faulty. Replace the Servomotor or linear encoder.	–
	A failure occurred in the SERVOPACK.	–	Turn the power supply to the SERVOPACK OFF and ON again. If an alarm still occurs, the SERVOPACK may be faulty. Replace the SERVOPACK.	–
A.CC0: Multiturn Limit Disagreement	When using a Direct Drive Servomotor, the setting of Pn205 (Multiturn Limit Setting) does not agree with the encoder.	Check the setting of Pn205.	Correct the setting of Pn205 (0 to 65,535).	page 6-26
	The multiturn limit of the encoder is different from that of the SERVOPACK. Or, the multiturn limit of the SERVOPACK has been changed.	Check the setting of Pn205 in the SERVOPACK.	Change the setting if the alarm occurs.	page 6-26
	A failure occurred in the SERVOPACK.	–	Turn the power supply to the SERVOPACK OFF and ON again. If an alarm still occurs, the SERVOPACK may be faulty. Replace the SERVOPACK.	–

Continued on next page.

Continued from previous page.

Alarm Number: Alarm Name	Possible Cause	Confirmation	Correction	Reference
A.CF1: Reception Failed Error in Feed- back Option Module Commu- nications	The cable between the Serial Converter Unit and SERVOPACK is not wired correctly or there is a faulty contact.	Check the wiring of the external encoder.	Correctly wire the cable between the Serial Converter Unit and SERVOPACK.	page 4-28
	A specified cable is not being used between Serial Converter Unit and SERVOPACK.	Check the wiring specifications of the external encoder.	Use a specified cable.	–
	The cable between the Serial Converter Unit and SERVOPACK is too long.	Measure the length of the cable that connects the Serial Converter Unit.	The length of the cable between the Serial Converter Unit and SERVOPACK must be 20 m or less.	–
	The sheath on cable between the Serial Converter Unit and SERVOPACK is broken.	Check the cable that connects the Serial Converter Unit.	Replace the cable between the Serial Converter Unit and SERVOPACK.	–
A.CF2: Timer Stopped Error in Feed- back Option Module Commu- nications	Noise entered the cable between the Serial Converter Unit and SERVOPACK.	–	Correct the wiring around the Serial Converter Unit, e.g., separate I/O signal lines from the Main Circuit Cables or ground.	–
	A failure occurred in the Serial Converter Unit.	–	Replace the Serial Converter Unit.	–
	A failure occurred in the SERVOPACK.	–	Replace the SERVOPACK.	–

Continued on next page.

Continued from previous page.

Alarm Number: Alarm Name	Possible Cause	Confirmation	Correction	Reference
A.d00: Position Deviation Overflow (The setting of Pn520 (Excessive Position Deviation Alarm Level) was exceeded by the position deviation.)	The Servomotor U, V, and W wiring is not correct.	Check the wiring of the Servomotor's Main Circuit Cables.	Make sure that there are no faulty contacts in the wiring for the Servomotor and encoder.	–
	The position command speed is too fast.	Reduce the position command speed and try operating the SERVOPACK.	Reduce the position reference speed or the reference acceleration rate, or reconsider the electronic gear ratio.	page 5-42
	The acceleration of the position reference is too high.	Reduce the reference acceleration and try operating the SERVOPACK.	Reduce the acceleration of the position reference with one of the following methods. <ul style="list-style-type: none"> • Reduce the acceleration rate (ACC) and deceleration rate (DEC) in the program table. • Reduce the settings of PnB29 (Acceleration Rate) and PnB2B (Deceleration Rate). 	–
	The setting of Pn520 (Excessive Position Deviation Alarm Level) is too low for the operating conditions.	Check Pn520 (Excessive Position Deviation Alarm Level) to see if it is set to an appropriate value.	Optimize the setting of Pn520.	page 8-7
	A failure occurred in the SERVOPACK.	–	Turn the power supply to the SERVOPACK OFF and ON again. If an alarm still occurs, the SERVOPACK may be faulty. Replace the SERVOPACK.	–
A.d01: Position Deviation Overflow Alarm at Servo ON	The servo was turned ON after the position deviation exceeded the setting of Pn526 (Excessive Position Deviation Alarm Level at Servo ON) while the servo was OFF.	Check the position deviation while the servo is OFF.	Optimize the setting of Pn526 (Excessive Position Deviation Alarm Level at Servo ON).	
A.d02: Position Deviation Overflow Alarm for Speed Limit at Servo ON	If position deviation remains in the deviation counter, the setting of Pn529 or Pn584 (Speed Limit Level at Servo ON) limits the speed when the servo is turned ON. This alarm occurs if a position reference is input and the setting of Pn520 (Excessive Position Deviation Alarm Level) is exceeded.	–	Optimize the setting of Pn520 (Excessive Position Deviation Alarm Level). Or, adjust the setting of Pn529 or Pn584 (Speed Limit Level at Servo ON).	page 8-7

Continued on next page.

Continued from previous page.

Alarm Number: Alarm Name	Possible Cause	Confirmation	Correction	Reference
A.d10: Motor-Load Position Deviation Overflow	The motor direction and external encoder installation orientation are backward.	Check the motor direction and the external encoder installation orientation.	Install the external encoder in the opposite direction, or change the setting of Pn002 = n.X□□□ (External Encoder Usage) to reverse the direction.	page 10-5
	There is an error in the connection between the load (e.g., stage) and external encoder coupling.	Check the coupling of the external encoder.	Check the mechanical coupling.	–
A.d30: Position Data Overflow	The position data exceeded $\pm 1,879,048,192$.	Check the input reference pulse counter.	Reconsider the operating specifications.	–
A.E00: Command Option Module IF Initialization Timeout Error	The connection between the SERVO-PACK and the command option module is faulty.	Check the connection between the SERVO-PACK and the command option module.	Correctly connect the command option module.	–
	A command option module fault occurred.	–	Replace the command option module.	–
	A SERVOPACK fault occurred.	–	Replace the SERVO-PACK.	–
A.E02: Command Option Module IF Synchronization Error 1	The timing of synchronization between the servomotor and command option module changed due to change in the communications cycle of the host controller connected to the command option module.	–	Turn the power supply OFF and then ON again. If the alarm occurs again, restart communications processing from the host controller.	–
	The connection between the SERVO-PACK and the command option module is faulty.	Check the connection between the SERVO-PACK and the command option module.	Correctly connect the command option module.	–
	A command option module fault occurred.	–	Replace the command option module.	–
	A SERVOPACK fault occurred.	–	Replace the SERVO-PACK.	–

Continued on next page.

Continued from previous page.

Alarm Number: Alarm Name	Possible Cause	Confirmation	Correction	Reference
A.E03: Command Option Module IF Communications Data Error	An error occurred due to noise in the communications between the SERVOPACK and the command option module.	—	Take measures against noise.	—
	The connection between the SERVO-PACK and the command option module is faulty.	Check the connection between the SERVO-PACK and the command option module.	Correctly connect the command option module.	—
	A command option module fault occurred.	—	Replace the command option module.	—
	A SERVOPACK fault occurred.	—	Replace the SERVO-PACK.	—
A.E70: Command Option Module Detection Failure	The connection between the SERVO-PACK and the command option module is faulty.	Check the connection between the SERVO-PACK and the command option module.	Correctly connect the command option module.	—
	The command option module is not connected.	—	Correctly connect the command option module.	—
	A command option module fault occurred.	—	Replace the command option module.	—
	A SERVOPACK fault occurred.	—	Replace the SERVO-PACK.	—
A.E71: Safety Option Module Detection Failure	The connection between the SERVO-PACK and the safety option module is faulty.	Check the connection between the SERVO-PACK and the safety option module.	Correctly connect the safety option module.	—
	The safety option module was disconnected.	—	Execute Fn014 (Resetting configuration error of option module) using the digital operator or SigmaWin+ and turn the power supply OFF and then ON again.	page 15-53
	A safety option module fault occurred.	—	Replace the safety option module.	—
	A SERVOPACK fault occurred.	—	Replace the SERVO-PACK.	—
A.E72: Feedback Option Module Detection Failure	There is a faulty connection between the SERVOPACK and the Feedback Option Module.	Check the connection between the SERVO-PACK and the Feedback Option Module.	Correctly connect the Feedback Option Module.	—
	The Feedback Option Module was disconnected.	—	Reset the Option Module configuration error and turn the power supply to the SERVOPACK OFF and ON again.	page 15-53
	A failure occurred in the Feedback Option Module.	—	Replace the Feedback Option Module.	—
	A failure occurred in the SERVOPACK.	—	Replace the SERVO-PACK.	—

Continued on next page.

Continued from previous page.

Alarm Number: Alarm Name	Possible Cause	Confirmation	Correction	Reference
A.E73: Unsupported Command Option Module	A command option module fault occurred.	–	Replace the command option module.	–
	A unsupported command option module was connected.	–	Connect a compatible command option module.	–
A.E74: Unsupported Safety Option Module	A safety option module fault occurred.	–	Replace the safety option module.	–
	A unsupported safety option module was connected.	–	Connect a compatible safety option module.	–
A.E75*2: Unsupported Feedback Option Module	A feedback option module fault occurred.	–	Replace the feedback option module.	–
	A unsupported feedback option module was connected.	Refer to the catalog of the connected feedback option module or the manual of the SERVOPACK.	Connect a compatible feedback option module.	–
A.E80: Command Option Module Unmatched Error	The command option module was replaced with a different model.	–	Execute Fn014 (Resetting configuration error of option module) using the digital operator or SigmaWin+ and turn the power supply OFF and then ON again.	–
A.EA2: Alarm in Current Communications between the INDEXER Module and SERVO- PACK 1	An error occurred in communications between the INDEXER Module and SERVOPACK during operation.	–	Take steps to reduce noise in the system such as improving frame ground.	page 15-46
A.EA3: Alarm in Current Communications between the INDEXER Module and SERVO- PACK 2	An error occurred in communications between the INDEXER Module and SERVOPACK during operation.	–	Take steps to reduce noise in the system such as improving frame ground.	page 15-46
A.Eb1: Safety Function Signal Input Tim- ing Error	The delay between activation of the /HWBB1 and /HWBB2 input signals for the HWBB was ten second or longer.	Measure the time delay between the /HWBB1 and /HWBB2 signals.	The output signal circuits or devices for /HWBB1 and /HWBB2 or the SERVOPACK input signal circuits may be faulty. Alternatively, the input signal cables may be disconnected. Check to see if any of these items are faulty or have been disconnected.	–
	A failure occurred in the SERVOPACK.	–	Replace the SERVOPACK.	–

Continued on next page.

15.2 Alarm Displays

15.2.2 Troubleshooting Alarms

Continued from previous page.

Alarm Number: Alarm Name	Possible Cause	Confirmation	Correction	Reference
A.EC8: Gate Drive Error 1 (An error occurred in the gate drive circuit.)	A failure occurred in the SERVOPACK.	–	Turn the power supply to the SERVOPACK OFF and ON again. If an alarm still occurs, the SERVOPACK may be faulty. Replace the SERVOPACK.	–
A.EC9: Gate Drive Error 2 (An error occurred in the gate drive circuit.)		–		–
A.Ed1: Command Option Module IF Command Timeout Error	Processing of the servo ON command from the command option module is not completed.	–	Input a servo ON command when the motor is stopped.	–
	Processing of the sensor ON command from the command option module is not completed.	–	Check that the encoder is connected properly.	–
A.F10: Power Supply Line Open Phase (The voltage was low for more than one second for phase R, S, or T when the main power supply was ON.)	The three-phase power supply wiring is not correct.	Check the power supply wiring.	Make sure that the power supply is correctly wired.	page 4-12
	The three-phase power supply is unbalanced.	Measure the voltage for each phase of the three-phase power supply.	Balance the power supply by changing phases.	–
	A single-phase power supply was input without specifying a single-phase AC power supply input (Pn00B = n.□1□□).	Check the power supply and the parameter setting.	Match the parameter setting to the power supply.	page 4-12
	A failure occurred in the SERVOPACK.	–	Turn the power supply to the SERVOPACK OFF and ON again. If an alarm still occurs, the SERVOPACK may be faulty. Replace the SERVOPACK.	–
FL-1*5: System Alarm	A failure occurred in the SERVOPACK.	–	Turn the power supply to the SERVOPACK OFF and ON again. If an alarm still occurs, the SERVOPACK may be faulty. Replace the SERVOPACK.	–
FL-2*5: System Alarm				–
FL-3*5: System Alarm				–
FL-4*5: System Alarm				–
FL-5*5: System Alarm				–
FL-6*5: System Alarm				–
FL-7*5: System Alarm				–

Continued on next page.

Continued from previous page.

Alarm Number: Alarm Name	Possible Cause	Confirmation	Correction	Reference
CPF00: Digital Operator Communications Error 1	There is a faulty connection between the Digital Operator and the SERVOPACK.	Check the connector contact.	Disconnect the connector and insert it again. Or, replace the cable.	–
	A malfunction was caused by noise.	–	Keep the Digital Operator or the cable away from sources of noise.	–
CPF01: Digital Operator Communications Error 2	A failure occurred in the Digital Operator.	–	Disconnect the Digital Operator and then connect it again. If an alarm still occurs, the Digital Operator may be faulty. Replace the Digital Operator.	–
	A failure occurred in the SERVOPACK.	–	Turn the power supply to the SERVOPACK OFF and ON again. If an alarm still occurs, the SERVOPACK may be faulty. Replace the SERVOPACK.	–

*1. Detection Conditions

- Rotary Servomotor
If either of the following conditions is detected, an alarm will occur.

- $$\text{Pn533 [min}^{-1}\text{]} \times \frac{\text{Encoder resolution}}{6 \times 10^5} \leq \frac{\text{Pn20E}}{\text{Pn210}}$$

- $$\text{Maximum motor speed [min}^{-1}\text{]} \times \frac{\text{Encoder resolution}}{\text{Approx. } 3.66 \times 10^{12}} \geq \frac{\text{Pn20E}}{\text{Pn210}}$$

- Linear Servomotor
If either of the following conditions is detected, an alarm will occur.

- $$\frac{\text{Pn585 [mm/s]}}{\text{Linear encoder pitch [\mu m]}} \times \frac{\text{Resolution of Serial Converter Unit}}{10} \leq \frac{\text{Pn20E}}{\text{Pn210}}$$

- $$\frac{\text{Pn385 [100 mm/s]}}{\text{Linear encoder pitch [\mu m]}} \times \frac{\text{Resolution of Serial Converter Unit}}{\text{Approx. } 6.10 \times 10^5} \geq \frac{\text{Pn20E}}{\text{Pn210}}$$

*2. Detection Conditions

- Rotary Servomotor
If either of the following conditions is detected, an alarm will occur.

- $$\text{Rated motor speed [min}^{-1}\text{]} \times 1/3 \times \frac{\text{Encoder resolution}}{6 \times 10^5} \leq \frac{\text{Pn20E}}{\text{Pn210}}$$

- $$\text{Maximum motor speed [min}^{-1}\text{]} \times \frac{\text{Encoder resolution}}{\text{Approx. } 3.66 \times 10^{12}} \geq \frac{\text{Pn20E}}{\text{Pn210}}$$

- Linear Servomotor
If either of the following conditions is detected, an alarm will occur.

- $$\frac{\text{Rated motor speed [mm/s]} \times 1/3}{\text{Linear encoder pitch [\mu m]}} \times \frac{\text{Resolution of Serial Converter Unit}}{10} \leq \frac{\text{Pn20E}}{\text{Pn210}}$$

- $$\frac{\text{Pn385 [100 mm/s]}}{\text{Linear encoder pitch [\mu m]}} \times \frac{\text{Resolution of Serial Converter Unit}}{\text{Approx. } 6.10 \times 10^5} \geq \frac{\text{Pn20E}}{\text{Pn210}}$$

*3. Refer to the relevant manual in the following list for details.

 **Σ-7-Series Peripheral Device Selection Manual (Manual No.: SIEP S800001 32)**

*4. The SERVOPACK will fail if the External Regenerative Resistor or Regenerative Resistor Unit is connected while the jumper is connected between the B2 and B3 terminals.

*5. These alarms are not stored in the alarm history. They are only displayed on the panel display.

15.2.3 INDEXER Module Alarm Displays and Troubleshooting

The INDEXER Module alarm list and the corresponding corrective actions are shown below.

Serial Command Negative Response	Alarm Number	Alarm Name	Meaning	Corrective Action	Servo-motor Stop Method	Alarm Reset
E12A	A.AEF	Firmware Execution Alarm	The firmware processing time was too long.	<ul style="list-style-type: none"> Upgrade the firm-ware version. Reduce the number of functions being used. 	Gr.1	N/A
E13A	A.AEF	Firmware Version Unmatched	The SERVOPACK does not supported this function, because the soft-ware version do not match.	<ul style="list-style-type: none"> Upgrade the SERVO-PACK software ver-sion. Use the SERVO-PACK that supports the corresponding function. Use the SERVO-PACK with the func-tion set disabled. 	Gr.1	N/A
E14A	A.AEF	Parameter Checksum Alarm (Detected only when control power supply is turned ON.)	Incorrect or cor-rupted parameters are stored in EEPROM. (This alarm can occur if the control power supply is turned OFF while the parameters are being initialized or changed.)	<ul style="list-style-type: none"> Initialize the param-eters with the PRMI-NIT command or FnB0B. If the problem is not solved, correct the parameters. 	Gr.1	N/A
E15A	A.AEF	Parameter Version Unmatched (Detected only when the control power supply is turned ON.)	The combination of the firmware version number and the parameter version number is wrong.	<ul style="list-style-type: none"> Change the firmware version. Change the param-eter version to match the firmware version. 	Gr.1	N/A
E16A	A.AEF	Parameter Out-of-range Alarm (Detected only when control power supply is turned ON.)	The moving method is set to a rotary method (PnB20 = 1, 2, or 3), but the origin set in PnB25 exceeds the software limits set in PnB21 and PnB23.	Correct the origin set-ting (PnB25) or the software limits (PnB21 and PnB23).	Gr.1	N/A

Continued on next page.

Continued from previous page.

Serial Command Negative Response	Alarm Number	Alarm Name	Meaning	Corrective Action	Servo-motor Stop Method	Alarm Reset
E17A	A.E00	Initial Communication Alarm between INDEXER Module and SERVOPACK (Detected only when control power supply is turned ON.)	The INDEXER Module failed in initialization of communications with the SERVOPACK when the control power was turned ON.	Take steps to reduce noise in the system such as improving frame ground.	Gr.1	N/A
	A.AEF		The SERVOPACK is not compatible with the INDEXER Module.	<ul style="list-style-type: none"> Upgrade the SERVOPACK's software version. Replace the SERVOPACK with a SERVOPACK that is compatible with the INDEXER Module. 		
	A.C90 or A.040		<ul style="list-style-type: none"> The INDEXER Module failed in parameter calculation during initial communications with the SERVOPACK when the control power was turned ON. This can happen in the following cases: <ul style="list-style-type: none"> When a parameter has been changed while the encoder is not connected When a parameter has been changed during occurrence of A.040 alarm 	<ul style="list-style-type: none"> Connect the encoder and then change the parameter. Cancel the A.040 alarm and then change the parameter. (If the alarm display is other than A.E00, it can be reset by turning the power OFF and back ON.) 		
E18A	A.EA2, A.EA3	Communication Alarm between INDEXER Module and SERVOPACK	An error occurred in communications between the INDEXER Module and SERVOPACK during operation.	Take steps to reduce noise in the system such as improving frame ground.	Gr.1	Available
E19A	A.AEF	Program Table Checksum Alarm (Detected only when control power supply is turned ON.)	The program table stored in flash memory was not recorded properly. (This alarm can occur if the control power supply is turned OFF while the program table is being saved or initialized.)	<ul style="list-style-type: none"> Initialize the program table with the PGMINIT command or FnB06. If the problem is not solved, correct the program table. 	Gr.1	Available* ¹
E1AA	A.AEF	Program Table Version Unmatched (Detected only when the control power is ON.)	The combination of the firmware version and the program table version is wrong.	<ul style="list-style-type: none"> Change the firmware version. Change the program table version to match the firmware version. 	Gr.1	Available* ¹

Continued on next page.

Continued from previous page.

Serial Command Negative Response	Alarm Number	Alarm Name	Meaning	Corrective Action	Servo-motor Stop Method	Alarm Reset
E1BA	A.AEF	Program Out-of-range Alarm (Detected only when control power supply is turned ON.)	A value set in the program table is not within the allowed setting range.	<ul style="list-style-type: none"> Change the firmware version. Change the program table version to match the firmware version. 	Gr. 1	Available* ¹
E1CA	A.AEF	ZONE Table Checksum Alarm (Detected only when control power supply is turned ON.)	The ZONE table stored in flash memory was not recorded properly. (This alarm can occur if the control power supply is turned OFF while the ZONE table is being saved or initialized.)	<ul style="list-style-type: none"> Initialize the ZONE table with the ZONEINIT command or FnB07.*² If the problem is not solved, correct the ZONE table. 	Gr. 1	Available* ²
E1DA	A.AEF	ZONE Table Version Unmatched (Detected only when the control power supply is turned ON.)	The combination of the firmware version and the ZONE table version is wrong.	<ul style="list-style-type: none"> Change the firmware version. Change the ZONE table version to match the firmware version. 	Gr. 1	Available* ²
E1EA	A.AEF	ZONE Table Out-of-range Alarm (Detected only when control power supply is turned ON.)	A value set in the ZONE table is not within the allowed setting range.	<ul style="list-style-type: none"> Change the firmware version. Change the ZONE table version to match the firmware version. 	Gr. 1	Available* ²
E1FA	A.AEF	JOG Speed Table Checksum Alarm (Detected only when control power supply is turned ON.)	The JOG speed table stored in flash memory was not recorded properly. (This alarm can occur if the control power supply is turned OFF while the JOG speed table is being saved or initialized.)	<ul style="list-style-type: none"> Initialize the JOG speed table with the JSPDINIT command or FnB08. If the problem is not solved, correct the JOG speed table. 	Gr. 1	Available* ³
E21A	A.AEF	JOG Speed Table Version Unmatched (Detected only when the control power supply is turned ON.)	The combination of the firmware version and the JOG speed table version is wrong.	<ul style="list-style-type: none"> Change the firmware version. Change the JOG speed table version to match the firmware version. 	Gr. 1	Available* ³
E22A	A.AEF	JOG Speed Table Out-of-range Alarm (Detected only when control power supply is turned ON.)	A value set in the JOG speed table is not within the allowed setting range.	<ul style="list-style-type: none"> Change the firmware version. Change the JOG speed table version to match the firmware version. 	Gr. 1	Available* ³

Continued on next page.

Continued from previous page.

Serial Command Negative Response	Alarm Number	Alarm Name	Meaning	Corrective Action	Servo-motor Stop Method	Alarm Reset
E23A	A.AEF	Insufficient Registration Distance Alarm	The registration distance was shorter than the deceleration distance when the /RGRT signal went ON to start registration operation. (The current position will exceed the position specified by registration.)	Either increase the registration distance or reduce the deceleration distance (increase the deceleration rate). The registration distance can be set by executing the RDST command or changing the RDST parameter in the program table. The deceleration rate can be changed by executing the DEC command or changing parameter PnB2B.	Gr.1	Available

- *1. These alarms can be reset, but a Canceled Program Table Error (E44E) will occur the next time you attempt to start program table operation, so program table operation will not be possible.
- *2. These alarms can be reset, but it is possible that the ZONE signals (POUT0 to POUT7) will be output incorrectly. When using the ZONE table, correct the ZONE table without resetting.
- *3. These alarms can be reset, but a Canceled JOG Speed Table Error (E46E) will occur the next time you attempt to start JOG speed table operation, so JOG speed table operation will not be possible.

15.2.4 Resetting INDEXER Alarms

If there is an ALM (Servo Alarm) signal, use one of the following methods to reset the alarm after eliminating the cause of the alarm.



Be sure to eliminate the cause of an alarm before you reset the alarm. If you reset the alarm and continue operation without eliminating the cause of the alarm, it may result in damage to the equipment or fire.

Resetting Alarms with the SigmaWin+

Use the following procedure to reset alarms with the SigmaWin+.

1. Click the  Servo Drive Button in the workspace of the Main Window of the SigmaWin+.
2. Select **Display Alarm** in the Menu Dialog Box. The Alarm Display Dialog Box will be displayed.

3. Click the **Reset axes** Button.

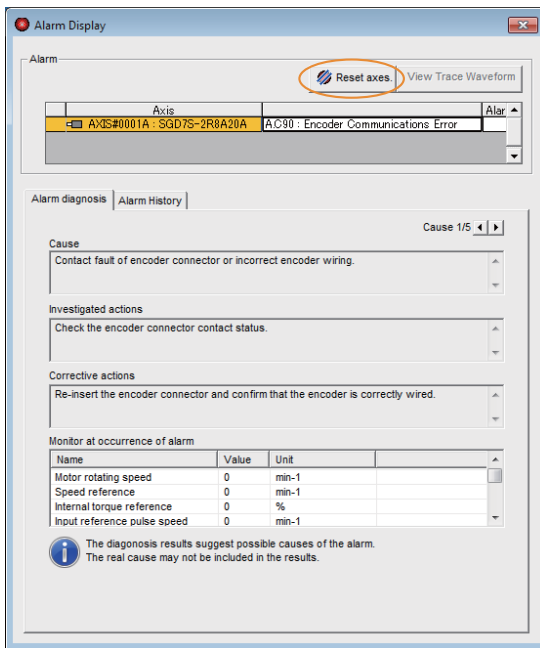

The alarm will be reset, and the alarm display will be cleared.
 This concludes the procedure to reset alarms.

Resetting Using /ALM-RST (Alarm Reset) Signal

Type	Signal Name	Connector Pin No.	Description
Input	/ALM-RST	CN1-7	Alarm reset

You can change the setting for the /ALM-RST signal with PnB52.

Parameter	Meaning	When Enabled	
PnB52	0 (default setting)	Resets alarms by switching input signal from OFF (open) to ON (closed).	After restart
	1	Resets alarms by switching input signal from ON (closed) to OFF (open).	
	2	Does not reset alarms. (Signal is ignored.)	
	3		

Resetting Alarms Using the Digital Operator

Press the **ALARM RESET** Key on the Digital Operator. Refer to the following manual for details on resetting alarms.

Σ-7-Series Digital Operator Operating Manual (Manual No.: SIEP S80001 33)

Information The alarm of the INDEXER module cannot be reset using the **ALARM RESET** Button on the digital operator. To reset the alarm of the INDEXER module, perform INDEXER alarm reset (FnBOC). For details, refer to the following section.
INDEXER Alarm Reset (FnBOC) on page 17-29

15.2.5 Displaying the INDEXER Alarm History



The alarm history displays up to the last ten alarms that have occurred in the SERVOPACK and INDEXER module.

Preparations

No preparations are required.

Applicable Tools

The following table lists the tools that you can use to display the alarm history.

Tool	Fn No./Function Name	Reference
Digital Operator	FnB0D	 Σ -7-Series Digital Operator Operating Manual (Manual No.: S1EP S800001 33)
SigmaWin+	<i>Troubleshooting – Display Alarm</i>	 <i>Operating Procedure</i> on page 15-51

Operating Procedure

Use the following procedure to display the alarm history.

1. Click the  Servo Drive Button in the workspace of the Main Window of the SigmaWin+.
2. Select **Display Alarm** in the Menu Dialog Box.
The Alarm Display Dialog Box will be displayed.
3. Click the **Alarm History** Tab.
The following display will appear and you can check the alarms that occurred in the past.

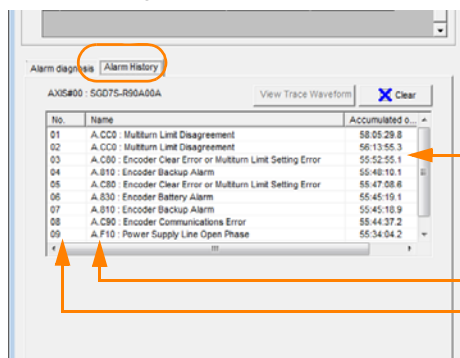

Accumulated operation time

Total operation time to the point at which the alarm occurred is displayed in increments of 100 ms from when the control power supply and main circuit power supply turned ON.

For 24-hour, 365-day operation, measurements are possible for approximately 13 years.

Alarm number: Alarm name

Alarms in order of occurrence

(Older alarms have higher numbers.)

Information

1. If the same alarm occurs consecutively within one hour, it is not saved in the alarm history. If it occurs after an hour or more, it is saved.
2. You can clear the alarm history by clicking the **Clear** Button. The alarm history is not cleared when alarms are reset or when the SERVOPACK main circuit power is turned OFF.

This concludes the procedure to display the alarm history.

15.2.6 Clearing the INDEXER Alarm History

You can clear the alarm history that is recorded in the SERVOPACK and INDEXER module. The alarm history is not cleared when alarms are reset or when the SERVOPACK main circuit power is turned OFF. You must perform the following procedure.

Preparations

Always check the following before you clear the alarm history.

- The parameters must not be write prohibited.

Applicable Tools

The following table lists the tools that you can use to clear the alarm history.

Tool	Fn No./Function Name	Reference
Digital Operator	FnBOC	Σ-7-Series Digital Operator Operating Manual (Manual No.: SIEP S800001 33)
SigmaWin+	<i>Troubleshooting – Display Alarm</i>	<i>Operating Procedure</i> on page 15-52

Operating Procedure

Use the following procedure to reset the alarm history.

1. Click the Servo Drive Button in the workspace of the Main Window of the SigmaWin+.
2. Select **Display Alarm** in the Menu Dialog Box. The Alarm Display Dialog Box will be displayed.
3. Click the **Alarm History** Tab.
4. Click the **Clear** Button. The alarm history will be cleared.

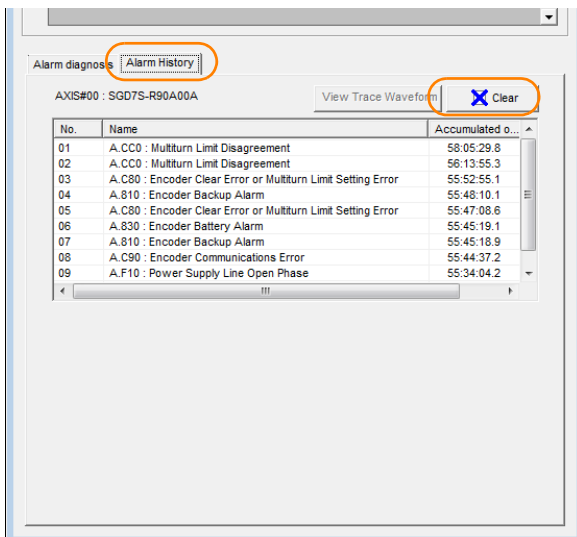

This concludes the procedure to reset the alarm history.

15.2.7 Resetting Alarms Detected in Option Modules

If any Option Modules are attached to the SERVOPACK, the SERVOPACK detects the presence and models of the connected Option Modules. If it finds any errors, it outputs alarms.

You can delete those alarms with this operation.

- Information**
 - This operation is the only way to reset alarms for Option Modules. The alarms are not reset when you reset other alarms or when you turn OFF the power supply to the SERVOPACK.
 - Always remove the cause of an alarm before you reset the alarm.

Preparations

Always check the following before you clear an alarm detected in an Option Module.

- The parameters must not be write prohibited.

Applicable Tools

The following table lists the tools that you can use to reset Option Module configuration errors.

Tool	Fn No./Function Name	Reference
Digital Operator	Fn014	Σ-7-Series Digital Operator Operating Manual (Manual No.: SIEP S800001 33)
SigmaWin+	<i>Troubleshooting – Display Alarm</i>	<i>Operating Procedure on page 15-53</i>

Operating Procedure

Use the following procedure to reset alarms detected in Option Modules.

- Click the Servo Drive Button in the workspace of the Main Window of the SigmaWin+.
- Select **Display Alarm** in the Menu Dialog Box. The Display Alarm Dialog Box will be displayed.
- Click the **Reset axes** Button.

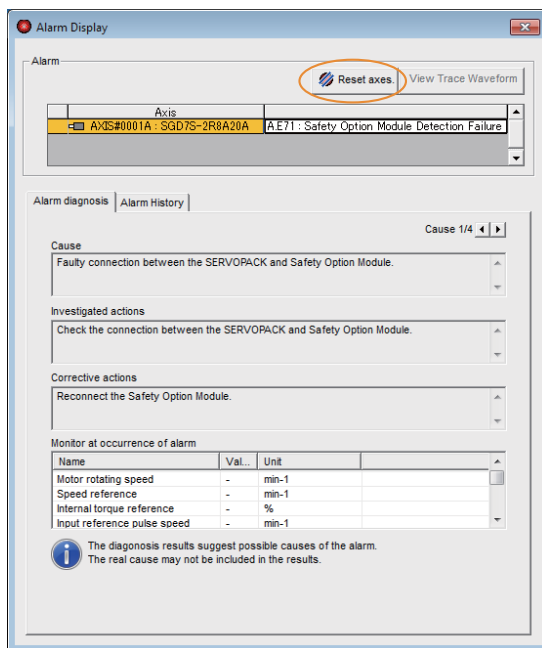

The Reset Option Module Configuration Error Dialog Box will be displayed.

4. Select the **Clear Check Box** for the Option Module for which to reset the alarm and then click the **Execute Button**.

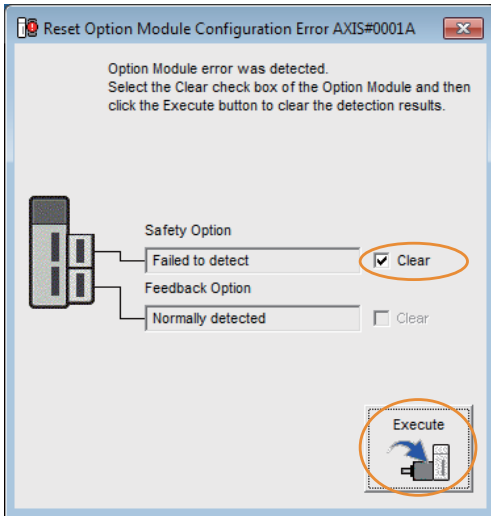

5. Read the precaution and then click the **OK Button**.

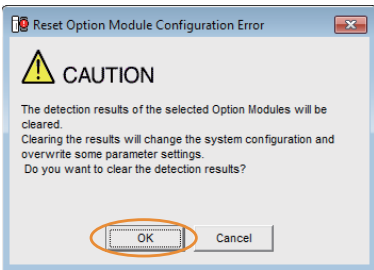

6. Read the precaution and then click the **OK Button**.

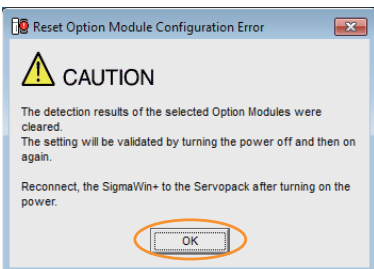

7. Turn the power supply to the **SERVOPACK OFF** and **ON** again.

This concludes the procedure to reset alarms detected in Option Modules.

15.2.8 Resetting Motor Type Alarms

The SERVOPACK automatically determines the type of Servomotor that is connected to it. If the type of Servomotor that is connected is changed, an A.070 alarm (Motor Type Change Detected) will occur the next time the SERVOPACK is started. If an A.070 alarm occurs, you must set the parameters to match the new type of Servomotor.

An A.070 alarm is reset by executing the Reset Motor Type Alarm utility function.

- Information**
1. This utility function is the only way to reset an A.070 alarm (Motor Type Change Detected). The errors are not reset when you reset alarms or turn OFF the power supply to the SERVOPACK.
 2. If an A.070 alarm occurs, first set the parameters according to the newly connected Servomotor type and then execute the Reset Motor Type Alarm utility function.



Preparations

Always check the following before you reset a motor type alarm.

- The parameters must not be write prohibited.

Applicable Tools

The following table lists the tools that you can use to clear the motor type alarm.

Tool	Fn No./Function Name	Reference
Digital Operator	Fn021	 Σ -7-Series Digital Operator Operating Manual (Manual No.: SIEP S800001 33)
SigmaWin+	Troubleshooting – Reset Motor Type Alarm	 Operating Procedure on page 15-55

Operating Procedure

Use the following procedure to reset Motor Type alarm.

1. Click the  Servo Drive Button in the workspace of the Main Window of the SigmaWin+.
2. Select **Reset Motor Type Alarm** in the Menu Dialog Box.
The Reset Motor Type Alarm Dialog Box will be displayed.
3. Click the **Reset** Button.

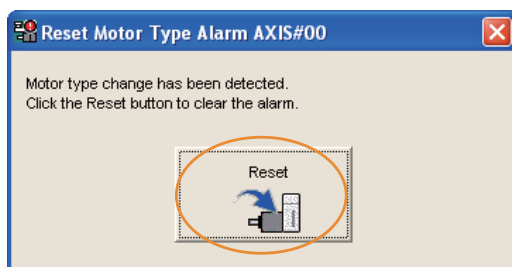

4. Read the precaution and then click the **OK** Button.

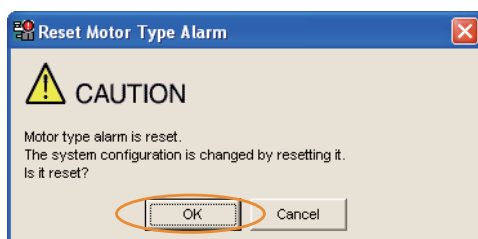

5. Read the precaution and then click the OK Button.

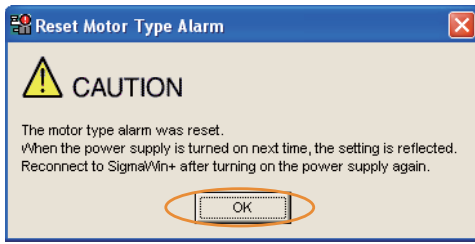



6. Turn the power supply to the SERVOPACK OFF and ON again.

This concludes the procedure to reset Motor Type alarms.

15.3 Warning Displays

Warnings are displayed to warn you before an alarm occurs. If a warning occurs in the SERVOPACK, the status is displayed as described below.

◆ Status Display

SERVOPACK Panel Display	The alarm number will be displayed. Refer to the following section for details.  1.5.1 Panel Display on page 1-10
Indicator	Green indicator: Remains unlit Red indicator: Remains lit Refer to the following section for details.  1.5.2 Indicators on page 1-11
Digital Operator	When a warning occurs, the warning code is displayed at the top left of the screen.
Response to the Alarm or Warning Read Command (ALM)	Warning code
Response to the Most Recent Error Read Command (ERR)	No change
ALM Signal	No change
/WARN Signal	Turns ON.

A list of warnings and the causes of and corrections for warnings are given below.

15.3.1 List of Warnings

This section gives the warning names, warning meanings, and warning code outputs in order of the warning numbers.

List of Warnings

Warning Number	Warning Name	Meaning	Warning Code Output		
			/AL01	/AL02	/AL03
A.900	Position Deviation Overflow	The position deviation exceeded the percentage set with the following formula: (Pn520 × Pn51E/100)	H	H	H
A.901	Position Deviation Overflow Alarm at Servo ON	The position deviation when the servo was turned ON exceeded the percentage set with the following formula: (Pn526 × Pn528/100)			
A.910	Overload	This warning occurs before an overload alarm (A.710 or A.720) occurs. If the warning is ignored and operation is continued, an alarm may occur.	L	H	H
A.911	Vibration	Abnormal vibration was detected during motor operation. The detection level is the same as A.520. Set whether to output an alarm or a warning by setting Pn310 (Vibration Detection Switch).			

Continued on next page.

Continued from previous page.

Warning Number	Warning Name	Meaning	Warning Code Output		
			/ALO1	/ALO2	/ALO3
A.912	Internal Temperature Warning 1 (Control Board Temperature Error)	The surrounding temperature of the control PCB is abnormal.			
A.913	Internal Temperature Warning 2 (Power Board Temperature Error)	The surrounding temperature of the power PCB is abnormal.			
A.920	Regenerative Overload	This warning occurs before an A.320 alarm (Regenerative Overload) occurs. If the warning is ignored and operation is continued, an alarm may occur.	H	L	H
A.921	Dynamic Brake Overload	This warning occurs before an A.731 alarm (Dynamic Brake Overload) occurs. If the warning is ignored and operation is continued, an alarm may occur.			
A.923	SERVOPACK Built-in Fan Stopped	The fan inside the SERVOPACK stopped.			
A.930	Absolute Encoder Battery Error	This warning occurs when the voltage of absolute encoder's battery is low.			
A.93B	Overheat Warning	The input voltage (temperature) for the overheat protection input (TH) signal exceeded the setting of Pn61C (Overheat Warning Level).	L	L	H
A.942	Speed Ripple Compensation Information Disagreement	The speed ripple compensation information stored in the encoder does not agree with the speed ripple compensation information stored in the SERVOPACK.	H	H	L
A.971	Undervoltage	This warning occurs before an A.410 alarm (Undervoltage) occurs. If the warning is ignored and operation is continued, an alarm may occur.	L	L	L
A.9A0	Overtravel	Overtravel was detected while the servo was ON.	H	L	L
A.9b0	Preventative Maintenance Warning	One of the consumable parts has reached the end of its service life.	H	L	H
A.A9F	Error	Some kind of error has occurred at the INDEXER Module.*	L	H	H

* Refer to the following sections for details.

 15.3.3 INDEXER Module Error Displays and Troubleshooting

Note: 1. A warning code is not output unless you set Pn001 to n.1□□□ (Output both alarm codes and warning codes).

2. Use Pn008 = n.□X□□ (Warning Detection Selection) to control warning detection. However, the following warnings are not affected by the setting of Pn008 = n.□X□□ and other parameter settings are required in addition to Pn008 = n.□X□□.

Warning	Parameters That Must Be Set to Select Warning Detection	Reference
A.911	Pn310 = n.□□□X (Vibration Detection Setting)	page 6-32
A.930	Pn008 = n.□□□X (Low Battery Voltage Alarm/Warning Selection)	page 15-3
A.942	Pn423 = n.□□X□ (Speed Ripple Compensation Information Disagreement Warning Detection Selection)	page 8-58
A.971	Pn008 = n.□□X□ (Function Selection for Undervoltage) (Not affected by the setting of Pn008 = n.□X□□.)	page 6-12
A.9A0	Pn00D = n.X□□□ (Overtravel Warning Detection Selection) (Not affected by the setting of Pn008 = n.□X□□.)	page 5-27
A.9b0	Pn00F = n.□□□X (Preventative Maintenance Selection)	page 9-16

15.3.2 Troubleshooting Warnings

The causes of and corrections for the warnings are given in the following table. Contact your Yaskawa representative if you cannot solve a problem with the correction given in the table.

Warning Number: Warning Name	Possible Cause	Confirmation	Correction	Reference
A.900: Position Deviation Overflow	The Servomotor U, V, and W wiring is not correct.	Check the wiring of the Servomotor's Main Circuit Cables.	Make sure that there are no faulty connections in the wiring for the Servomotor and encoder.	–
	A SERVOPACK gain is too low.	Check the SERVO-PACK gains.	Increase the servo gain, e.g., by using autotuning without a host reference.	page 8-23
	The acceleration of the position reference is too high.	Reduce the reference acceleration and try operating the SERVO-PACK.	Reduce the acceleration of the position reference with one of the following methods. <ul style="list-style-type: none"> • Reduce the acceleration rate (ACC) and deceleration rate (DEC) in the program table. • Reduce the settings of PnB29 (Acceleration Rate) and PnB2B (Deceleration Rate). 	–
	The excessive position deviation alarm level (Pn520 × Pn51E/100) is too low for the operating conditions.	Check excessive position deviation alarm level (Pn520 × Pn51E/100) to see if it is set to an appropriate value.	Optimize the settings of Pn520 and Pn51E.	page 8-7
	A failure occurred in the SERVO-PACK.	–	Turn the power supply to the SERVOPACK OFF and ON again. If an alarm still occurs, the SERVOPACK may be faulty. Replace the SERVOPACK.	–
A.901: Position Deviation Overflow Alarm at Servo ON	The position deviation when the servo was turned ON exceeded the percentage set with the following formula: (Pn526 × Pn528/100)	–	Optimize the setting of Pn528 (Excessive Position Error Warning Level at Servo ON).	–

Continued on next page.

15.3 Warning Displays

15.3.2 Troubleshooting Warnings

Continued from previous page.

Warning Number: Warning Name	Possible Cause	Confirmation	Correction	Reference
A.910: Overload (warning before an A.710 or A.720 alarm occurs)	The wiring is not correct or there is a faulty connection in the motor or encoder wiring.	Check the wiring.	Make sure that the Servomotor and encoder are correctly wired.	–
	Operation was performed that exceeded the overload protection characteristics.	Check the motor overload characteristics and Run command.	Reconsider the load and operating conditions. Or, increase the motor capacity.	–
	An excessive load was applied during operation because the Servomotor was not driven because of mechanical problems.	Check the operation reference and motor speed.	Remove the mechanical problem.	–
	The overload warning level (Pn52B) is not suitable.	Check that the overload warning level (Pn52B) is suitable.	Set a suitable overload warning level (Pn52B).	page 5-39
	A failure occurred in the SERVOPACK.	–	The SERVOPACK may be faulty. Replace the SERVOPACK.	–
A.911: Vibration	Abnormal vibration was detected during motor operation.	Check for abnormal motor noise, and check the speed and torque waveforms during operation.	Reduce the motor speed. Or, reduce the servo gain with custom tuning.	page 8-41
	The setting of Pn103 (Moment of Inertia Ratio) is greater than the actual moment of inertia or was greatly changed.	Check the moment of inertia ratio or mass ratio.	Set Pn103 (Moment of Inertia Ratio) to an appropriate value.	page 8-15
	The vibration detection level (Pn312 or Pn384) is not suitable.	Check that the vibration detection level (Pn312 or Pn384) is suitable.	Set a suitable vibration detection level (Pn312 or Pn384).	page 6-32

Continued on next page.

Continued from previous page.

Warning Number: Warning Name	Possible Cause	Confirmation	Correction	Reference
A.912: Internal Temperature Warning 1 (Control Board Temperature Error)	The surrounding temperature is too high.	Check the surrounding temperature using a thermometer. Or, check the operating status with the SERVOPACK installation environment monitor.	Decrease the surrounding temperature by improving the SERVOPACK installation conditions.	page 3-7
	An overload alarm was reset by turning OFF the power supply too many times.	Check the alarm display to see if there is an overload alarm.	Change the method for resetting the alarm.	–
	There was an excessive load or operation was performed that exceeded the regenerative processing capacity.	Use the accumulated load ratio to check the load during operation, and use the regenerative load ratio to check the regenerative processing capacity.	Reconsider the load and operating conditions.	–
	The SERVOPACK installation orientation is not correct or there is insufficient space around the SERVOPACK.	Check the SERVOPACK installation conditions.	Install the SERVOPACK according to specifications.	page 3-4, page 3-7
	A failure occurred in the SERVOPACK.	–	The SERVOPACK may be faulty. Replace the SERVOPACK.	–
A.913: Internal Temperature Warning 2 (Power Board Temperature Error)	The surrounding temperature is too high.	Check the surrounding temperature using a thermometer. Or, check the operating status with the SERVOPACK installation environment monitor.	Decrease the surrounding temperature by improving the SERVOPACK installation conditions.	page 3-7
	An overload alarm was reset by turning OFF the power supply too many times.	Check the alarm display to see if there is an overload alarm.	Change the method for resetting the alarm.	–
	There was an excessive load or operation was performed that exceeded the regenerative processing capacity.	Use the accumulated load ratio to check the load during operation, and use the regenerative load ratio to check the regenerative processing capacity.	Reconsider the load and operating conditions.	–
	The SERVOPACK installation orientation is not correct or there is insufficient space around the SERVOPACK.	Check the SERVOPACK installation conditions.	Install the SERVOPACK according to specifications.	page 3-4, page 3-7
	A failure occurred in the SERVOPACK.	–	The SERVOPACK may be faulty. Replace the SERVOPACK.	–

Continued on next page.

Continued from previous page.

Warning Number: Warning Name	Possible Cause	Confirmation	Correction	Reference
A.920: Regenerative Overload (warning before an A.320 alarm occurs)	The power supply voltage exceeded the specified range.	Measure the power supply voltage.	Set the power supply voltage within the specified range.	–
	There is insufficient external regenerative resistance, regenerative resistor capacity, or SERVOPACK capacity, or there has been a continuous regeneration state.	Check the operating conditions or the capacity using the SigmaJunmaSize+ Capacity Selection Software or another means.	Change the regenerative resistance value, regenerative resistance capacity, or SERVOPACK capacity. Reconsider the operating conditions using the SigmaJunmaSize+ Capacity Selection Software or other means.	–
	There was a continuous regeneration state because a negative load was continuously applied.	Check the load applied to the Servomotor during operation.	Reconsider the system including the servo, machine, and operating conditions.	–
A.921: Dynamic Brake Overload (warning before an A.731 alarm occurs)	The Servomotor was rotated by an external force.	Check the operation status.	Implement measures to ensure that the motor will not be rotated by an external force.	–
	When the Servomotor was stopped with the dynamic brake, the rotational or linear kinetic energy exceeded the capacity of the dynamic brake resistor.	Check the power consumed by the DB resistor to see how frequently the DB is being used.	Reconsider the following: <ul style="list-style-type: none"> • Reduce the Servomotor command speed. • Decrease the moment of inertia or mass. • Reduce the frequency of stopping with the dynamic brake. 	–
	A failure occurred in the SERVOPACK.	–	The SERVOPACK may be faulty. Replace the SERVOPACK.	–
A.923: SERVOPACK Built-in Fan Stopped	The fan inside the SERVOPACK stopped.	Check for foreign matter inside the SERVOPACK.	Remove foreign matter from the SERVOPACK. If an alarm still occurs, the SERVOPACK may be faulty. Replace the SERVOPACK.	–
A.930: Absolute Encoder Battery Error (The absolute encoder battery voltage was lower than the specified level.) (Detected only when an absolute encoder is connected.)	The battery connection is faulty or a battery is not connected.	Check the battery connection.	Correct the battery connection.	page 4-27
	The battery voltage is lower than the specified value (2.7 V).	Measure the battery voltage.	Replace the battery.	page 15-3
	A failure occurred in the SERVOPACK.	–	The SERVOPACK may be faulty. Replace the SERVOPACK.	–

Continued on next page.

Continued from previous page.

Warning Number: Warning Name	Possible Cause	Confirmation	Correction	Reference
A.93B: Overheat Warning	The surrounding temperature is too high.	Check the surrounding temperature using a thermometer.	Lower the surrounding temperature by improving the installation conditions of the Linear Servomotor or the machine.	–
	Operation was performed under an excessive load.	Use the accumulated load ratio to check the load during operation.	Reconsider the load and operating conditions.	–
	A failure occurred in the SERVOPACK.	–	The SERVOPACK may be faulty. Replace the SERVOPACK.	–
	The temperature detection circuit in the Linear Servomotor is faulty or the sensor attached to the machine is faulty.	–	The temperature detection circuit in the Linear Servomotor may be faulty or the sensor attached to the machine may be faulty. Replace the Linear Servomotor or repair the sensor attached to the machine.	–
A.942: Speed Ripple Compensation Information Disagreement	The speed ripple compensation information stored in the encoder does not agree with the speed ripple compensation information stored in the SERVOPACK.	–	Reset the speed ripple compensation value on the SigmaWin+.	page 8-58
		–	Set Pn423 to n.□□1□ (Do not detect A.942 alarms). However, changing the setting may increase the speed ripple.	page 8-58
		–	Set Pn423 to n.□□□0 (Disable torque ripple compensation). However, changing the setting may increase the speed ripple.	page 8-58
A.971: Undervoltage	For a 200-V SERVOPACK, the AC power supply voltage dropped below 140 V.	Measure the power supply voltage.	Set the power supply voltage within the specified range.	–
	For a 100-V SERVOPACK, the AC power supply voltage dropped below 60 V.	Measure the power supply voltage.	Set the power supply voltage within the specified range.	–
	A momentary power interruption occurred.	Measure the power supply voltage.	If you have changed the setting of Pn509 (Momentary Power Interruption Hold Time), decrease the setting.	page 6-11
	The SERVOPACK fuse is blown out.	–	Replace the SERVOPACK and connect a reactor.	page 4-25
	A failure occurred in the SERVOPACK.	–	The SERVOPACK may be faulty. Replace the SERVOPACK.	–

Continued on next page.

Continued from previous page.

Warning Number: Warning Name	Possible Cause	Confirmation	Correction	Reference
A.9A0: Overtravel (Overtravel status was detected.)	Overtravel was detected while the servo was ON.	Check the status of the overtravel signals on the input signal monitor.	Even if an overtravel signal is not shown by the input signal monitor, momentary overtravel may have been detected. Take the following precautions. <ul style="list-style-type: none"> • Do not specify movements that would cause overtravel from the host controller. • Check the wiring of the overtravel signals. • Implement countermeasures against noise. 	page 5-29
A.9b0: Preventative Maintenance Warning	One of the consumable parts has reached the end of its service life.	–	Replace the part. Contact your Yaskawa representative for replacement.	page 9-16
A.A9F: Error	An error occurred in the INDEXER Module.	Use the SigmaWin+ to check the serial command negative response of the INDEXER Module.	Follow the correction for a serial command negative response from the INDEXER Module.	page 15-65

15.3.3 INDEXER Module Error Displays and Troubleshooting

Negative responses (error responses) to input signals, serial commands, or operations from the Digital Operator are known as errors.

The servo will not be turned OFF when an error occurs.

◆ Status Displays

SERVOPACK Panel Display	"A.A9F" is displayed for 2 seconds.
Indicator	Red indicator: Flashes for 2 seconds. Refer to the following section for details.  1.5.2 Indicators on page 1-11
Digital Operator	"A.A9F" is displayed for 2 seconds at the top left of the screen.
Response to the Alarm or Warning Read Command (ALM)	No change
Response to the Most Recent Error Read Command (ERR)	Error code (the most recent (closest) error code)
ALM Signal	No change
/WARN Signal	The signal is valid for 2 seconds.

The INDEXER Module error displays and the corrective actions are shown below.

Serial Command Negative Response	Alarm Number	Error Name	Meaning	Corrective Action
E41E	A.A9F	Program Table Save Failure Error	While writing data to the flash memory, a failure occurred during one of the following operation. <ul style="list-style-type: none"> • While saving a program table by using a PGMSTORE command • While saving a program table by using FnB03 • While initializing a program table by using a PGMINIT command • While initializing a program table by using FnB06 	Repair the hardware.
E42E	A.A9F	ZONE Table Save Failure Error	While writing data to the flash memory, a failure occurred during one of the following operation. <ul style="list-style-type: none"> • While saving a ZONE table by using a ZONESTORE command • While saving a ZONE table by using FnB04 • While initializing a ZONE table by using a ZONEINIT command • While initializing a ZONE table by using FnB07 	Repair the hardware.

Continued on next page.

Continued from previous page.

Serial Command Negative Response	Alarm Number	Error Name	Meaning	Corrective Action
E43E	A.A9F	JOG Speed Table Save Failure Error	<p>While writing data to the flash memory, a failure occurred during one of the following operation.</p> <ul style="list-style-type: none"> • While saving a JOG speed table by using a JSPDSTORE command • While saving a JOG speed table by using FnB05 • While initializing a JOG speed table by using a JSPDINIT command • While initializing a JOG speed table by using FnB08 	Repair the hardware.
E44E	A.A9F	Canceled Program Table Error	There was a request to start program table operation even though an E19A or E1BA alarm occurred when the control power supply was turned ON.	Eliminate the cause of the alarm.
E46E	A.A9F	Canceled JOG Speed Table Error	There was a request to start JOG speed table operation even though an E1FA or E22A alarm occurred when the control power supply was turned ON.	Eliminate the cause of the alarm.
E47E	A.A9F	Serial Communications Receiving Buffer Overflow Error	<p>There was an overflow in the reception buffer used for serial commands.</p> <ul style="list-style-type: none"> • An error will occur if too many serial commands are sent consecutively without waiting for the responses. (Normally, the reception buffer will not overflow if there is command/response handshaking.) • When an overflow has occurred, error code E47E will be returned and all of the data that has accumulated in the reception buffer will be discarded. 	Wait for a response to be received before sending the next command. The reception buffer can contain up to 100 commands.
E48E	A.A9F	Serial Communications Parity Error	<p>A parity check error occurred with the serial command.</p> <ul style="list-style-type: none"> • This error will occur if even parity is not being used. • The command that caused this error will be discarded and no response will be returned. • There will be no response, but the /WARN output and LED indicators will indicate that an error has occurred. 	<ul style="list-style-type: none"> • Check the serial communications protocol (PnB00) and bit rate (PnB01) settings. • Check the wiring. • If noise may be causing the problem, take steps to reduce noise such as using communications cables with ferrite cores.

Continued on next page.

Continued from previous page.

Serial Command Negative Response	Alarm Number	Error Name	Meaning	Corrective Action
E49E	A.A9F	Serial Communications Framing Error	<p>A stop bit detection error occurred with the serial command.</p> <ul style="list-style-type: none"> The command that caused this error will be discarded and no response will be returned. There will be no response, but the /WARN output and LED indicators will indicate that an error has occurred. 	<ul style="list-style-type: none"> Check the serial communications protocol (PnB00) and bit rate (PnB01) settings. Check the wiring. If noise may be causing the problem, take steps to reduce noise such as using communications cables with ferrite cores.
E4AE	A.A9F	Serial Communications Overrun Error	<p>Serial command reception failed.</p> <ul style="list-style-type: none"> The hardware's reception buffer was overwritten with the subsequent data. (Normally, data is read before it is overwritten, so this error does not occur.) 	Repair the hardware.
E4BE	A.A9F	Moving Disabled Error due to P-OT	<p>Travel in the forward direction was requested when P-OT was in effect. (Forward movement is disabled when P-OT (forward overtravel) is in effect.)</p>	<ul style="list-style-type: none"> When P-OT is being used, move to a position where the P-OT is not in effect. When P-OT is not being used, disable P-OT in the parameter (PnB0F = 3).
E4CE	A.A9F	Moving Disabled Error due to N-OT	<p>Travel in the reverse direction was requested when N-OT was in effect. (Reverse movement is disabled when N-OT (reverse overtravel) is in effect.)</p>	<ul style="list-style-type: none"> When N-OT is being used, move to a position where the N-OT is not in effect. When N-OT is not being used, disable N-OT in the parameter (PnB10 = 3).

Continued on next page.

Continued from previous page.

Serial Command Negative Response	Alarm Number	Error Name	Meaning	Corrective Action
E4DE	A.A9F	Moving Disabled Error due to P-LS	The specified target position exceeds the position reference of forward software limit set in PnB21.	<ul style="list-style-type: none"> • Check the target position specification. • Check the forward software limit in PnB21. • Check the moving mode (rotary or linear) set in PnB20. • If software limits are not being used, either select a rotary moving mode in PnB20 or disable the software limits by setting PnB21 = PnB23 = 0.
E4EE	A.A9F	Moving Disabled Error due to N-LS	The specified target position exceeds the position reference of reverse software limit set in PnB23.	<ul style="list-style-type: none"> • Check the target position specification. • Check the reverse software limit in PnB23. • Check the moving mode (rotary or linear) set in PnB20. • If software limits are not being used, either select a rotary moving mode in PnB20 or disable the software limits by setting PnB21 = PnB23 = 0.
E4FE	A.A9F	Position Reference Out-of-range Error	The moving method is set to rotary (PnB20 = 1, 2, or 3) and the target position specification exceeds the position reference limits in PnB21 and PnB23.	<ul style="list-style-type: none"> • Check the target position specification. • Check the positioning range set with PnB21 and PnB23. • Check the moving method (rotary or linear) set in PnB20.

Continued on next page.

Continued from previous page.

Serial Command Negative Response	Alarm Number	Error Name	Meaning	Corrective Action
E51E	A.A9F	Target Position Unspecified Error	Even though the target position was not specified even once, there was a request by the ST command to start positioning or a request by the RS command to start registration positioning.	Specify a target position with a command such as the POS command, STnnnnn- nnn command, or RSnnnnnnnn command.
E52E	A.A9F	Registration Distance Unspecified Error	Even though the registration distance was not specified even once, there was a request by the RS command to start registration positioning.	Specify a registration distance with the RDST command.
E53E	A.A9F	Move Reference Duplication Error	There was a new move reference requested even though the system was already moving in a positioning or other traveling operation.	<ul style="list-style-type: none"> Send the next move reference request only after the current movement is completed (Position reference distribution is completed). A movement can be interrupted or canceled with the HOLD or SKIP commands. Also, STOP can be specified in the target position specification (POS) with the program table.

Continued on next page.

Continued from previous page.

Serial Command Negative Response	Alarm Number	Error Name	Meaning	Corrective Action
E54E	A.A9F	Servo ON Incomplete Error	<p>The servo is not ON.</p> <ul style="list-style-type: none"> There was a positioning request or other move reference request in servo OFF status. <p>The servo went OFF during program table operation. (Program table operation will be interrupted while just the step that was being executed is canceled (If LOOP ≠ 1, the first LOOP is canceled.))</p>	<p>Send the move reference request only after turning the servo ON by turning ON the /S-ON signal, setting PnBOE = 2 so that the /S-ON signal is always ON, or executing the SVON command. There are two possibilities.</p> <ul style="list-style-type: none"> The program can be canceled with the /PGMRES signal or PGMRES command. The servo can be turned ON and the program can be restarted with the /START-STOP signal or the START command.
E55E	A.A9F	Servo ON Failure Error	<p>The servo could not be turned ON within 2 s after turning ON the /S-ON signal or executing the SVON command.</p> <ul style="list-style-type: none"> The motor is rotating during servo ON execution. The main power supply went OFF during servo ON execution. Hard wire base block status (HWBB status) <p>Error E5BE will occur if there was an alarm when the servo ON request was sent using the SVON command. Error E5CE will occur if the main power supply was OFF when the servo ON request was sent.</p>	<ul style="list-style-type: none"> Turn the servo ON when the motor is stopped. Check the main power supply. Turn ON signals /HWBB1, /HWBB2. After that, temporarily establish the servo OFF status by turning the /S-ON signal OFF or sending the SVOFF command, then turn the servo ON again.
E56E	A.A9F	Undefined Serial Command Error	<ul style="list-style-type: none"> There was a syntax error in the serial command. There was a number in the serial command longer than 8 digits or 10 digits. 	<p>Check the serial command's character string.</p>
E57E	A.A9F	Address Out-of-range Error	<p>The specified address was incorrect for a parameter, program table, ZONE table, JOG speed table, alarm history, or monitor read/write command.</p>	<p>Check the address.</p>

Continued on next page.

Continued from previous page.

Serial Command Negative Response	Alarm Number	Error Name	Meaning	Corrective Action
E58E	A.A9F	Data Out-of-range Error	The specified setting was incorrect in a parameter or program table write command.	Check the setting.
E59E	A.A9F	Communication Failure Error between INDEXER Module and SERVOPACK	Communications between the INDEXER Module and the SERVOPACK have failed.	Check the version of the SERVOPACK.
E5AE	A.A9F	Execution Disabled while Servo ON Error	Some of the utility functions, such as parameter initialization, has been requested while still in the servo ON status. For safety, the following functions cannot be executed in the servo ON status. <ul style="list-style-type: none"> Serial commands: Parameter initialization, absolute encoder reset, motor current zero adjustment SigmaWin+: Parameter initialization 	Execute these functions after turning the servo OFF.
E5BE	A.A9F	Execution Disabled while Alarm Activated Error	Servo ON was requested (the SVON command was executed) while there was an alarm.	Turn the servo ON after eliminating the cause of the alarm and clearing the alarm.
E5CE	A.A9F	Execution Disabled while Main Power OFF Error	Servo ON was requested (the SVON command was executed) while the main power supply was OFF.	Turn the servo ON after turning ON the main power supply.
E5DE	A.A9F	Homing Method Unspecified Error	The homing method is not specified. <ul style="list-style-type: none"> Homing start was requested (/HOME signal was turned ON or ZRN command was executed) without setting the homing method. 	Specify the homing method in PnB31.
E5EE	A.A9F	Execution Disabled during Program Table Operation Error	<ul style="list-style-type: none"> There was a request to execute a process that is not allowed during program table operation while program table operation was in progress or on hold. There was an attempt to change the program table while program table operation was in progress or on hold. There was a request to start positioning by a serial command while program table operation was in progress or on hold. 	Request execution of the process again after canceling program table operation by turning the /PGMRES signal ON.
E5FE	A.A9F	Session Conflict Error	There was a request that could not be executed at the same time as the function that was being executed. Example: There was a request to start program table operation while the program table was being initialized.	Execute the operation again after the execution of the current function is completed.

Continued on next page.

Continued from previous page.

Serial Command Negative Response	Alarm Number	Error Name	Meaning	Corrective Action
E61E	A.A9F	Encoder Mismatch Error	<p>There was a request that was incompatible with the connected encoder.</p> <p>Examples:</p> <ul style="list-style-type: none"> An Absolute Encoder Reset (ABSPGRES command) was requested when an incremental encoder is connected. Homing start was requested (/HOME signal was turned ON or ZRN command was executed) when an absolute encoder is connected. <p>(An absolute encoder can be used as an incremental encoder if parameter Pn002.2 = 1.)</p>	Check the encoder.
E62E	A.A9F	No A.CC0 Alarm Occurred Error	<p>A Multi-turn Limit Setting (MLTLIMSET command) was requested even though alarm A.CC0 has not occurred.</p> <p>(Alarm A.CC0 indicates that Pn205 does not match the setting in the encoder after the multiturn limit setting in Pn205 was changed and the control power supply was turned OFF and ON.)</p>	Use the Multi-turn Limit Setting operation to adjust the setting in the encoder to match Pn205 only after alarm A.CC0 has occurred.
E63E	A.A9F	Continuous Stop Execution Disabled Error	<p>An attempt was made to execute a continuous stop under conditions where it could not be executed.</p> <p>Examples:</p> <ul style="list-style-type: none"> The coordinates have been set to linear moving method. The immediately-preceding table target position is not ±INFINITE. The immediately-preceding table target position is ±INFINITE, but the registration distance is set. A value other than 1 has been set for the execution count. 	Execute a continuous stop under conditions where it can be executed.

15.4 Troubleshooting Based on the Operation and Conditions of the Servomotor

This section provides troubleshooting based on the operation and conditions of the Servomotor, including causes and corrections.

Problem	Possible Cause	Confirmation	Correction	Reference
Servomotor Does Not Start	The control power supply is not turned ON.	Measure the voltage between control power supply terminals.	Turn OFF the power supply to the servo system. Correct the wiring so that the control power supply is turned ON.	–
	The main circuit power supply is not turned ON.	Measure the voltage across the main circuit power input terminals.	Turn OFF the power supply to the servo system. Correct the wiring so that the main circuit power supply is turned ON.	–
	The I/O signal connector (CN1) pins are not wired correctly or are disconnected.	Turn OFF the power supply to the servo system. Check the wiring condition of the I/O signal connector (CN1) pins.	Correct the wiring of the I/O signal connector (CN1) pins.	page 4-36, page 9-5
	The wiring for the Servomotor Main Circuit Cables or Encoder Cable is disconnected.	Check the wiring conditions.	Turn OFF the power supply to the servo system. Wire the cable correctly.	–
	There is an overload on the Servomotor.	Operate the Servomotor with no load and check the load status.	Turn OFF the power supply to the servo system. Reduce the load or replace the Servomotor with a larger capacity.	–
	The type of encoder that is being used does not agree with the setting of Pn002 = n.□X□□ (Encoder Usage).	Check the type of the encoder that is being used and the setting of Pn002 = n.□X□□.	Set Pn002 = n.□X□□ according to the type of the encoder that is being used.	page 6-23
	Settings for input signals PnB03 to PnB12 are incorrect.	Check settings of input signals PnB03 to PnB12.	Correct the settings of input signals PnB03 to PnB12.	page 6-3, page 9-5
	The /S-ON (Servo ON) signal was not received.	Check the commands sent from the host controller.	Turn ON the /S-ON signal from the host controller.	page 9-5
	The P-OT (Forward Drive Prohibit) or N-OT (Reverse Drive Prohibit) signal is still OFF.	Check the P-OT and N-OT signals.	Turn ON the P-OT and N-OT signals.	page 9-5
	The current position of the servomotor is outside the software limit setting range.	Check the error at the INDEXER Module.	Check the motor position and software limit setting (PnB21, PnB23), then move the servomotor into the software limit setting range.	–
There is no position reference, or it is incorrect.	Check the error at the INDEXER Module.	Set the program table correctly.	–	

Continued on next page.

Continued from previous page.

Problem	Possible Cause	Confirmation	Correction	Reference
Servomotor Does Not Start	The safety input signals (/HWBB1 or /HWBB2) were not turned ON.	Check the /HWBB1 and /HWBB2 input signals.	Turn ON the /HWBB1 and /HWBB2 input signals. If you are not using the safety function, connect the Safety Jumper Connector (provided as an accessory) to CN8.	page 9-5
	A failure occurred in the SERVOPACK.	–	Turn OFF the power supply to the servo system. Replace the SERVOPACK.	–
	The polarity detection was not executed.	Check the setting of Pn080 = n.□□□X (Polarity Sensor Selection).	Correct the parameter setting.	page 5-23
		Check the /S-ON (Servo ON) signal.	<ul style="list-style-type: none"> If you are using an incremental linear encoder, input the /S-ON signal from the host controller. If you are using an absolute linear encoder, execute polarity detection. 	page 5-24
Servomotor Moves Instantaneously, and Then Stops	There is a mistake in the Servomotor wiring.	Turn OFF the power supply to the servo system. Check the wiring.	Wire the Servomotor correctly.	–
	There is a mistake in the wiring of the encoder or Serial Converter Unit.	Turn OFF the power supply to the servo system. Check the wiring.	Wire the Serial Converter Unit correctly.	–
	There is a mistake in the linear encoder wiring.	Turn OFF the power supply to the servo system. Check the wiring.	Wire the cable correctly.	–
	The setting of Pn282 (Linear Encoder Pitch) is not correct.	Check the setting of Pn282.	Correct the setting of Pn282.	page 5-16
	The count-up direction of the linear encoder does not match the forward direction of the Moving Coil in the motor.	Check the directions.	Change the setting of Pn080 = n.□□X□ (Motor Phase Selection). Place the linear encoder and motor in the same direction.	page 5-21
	Polarity detection was not performed correctly.	Check to see if electrical angle 2 (electrical angle from polarity origin) at any position is between $\pm 10^\circ$.	Correct the settings for the polarity detection-related parameters.	–
Servomotor Speed Is Unstable	There is a faulty connection in the Servomotor wiring.	The connector connections for the power line (U, V, and W phases) and the encoder or Serial Converter Unit may be unstable. Turn OFF the power supply to the servo system. Check the wiring.	Tighten any loose terminals or connectors and correct the wiring.	–

Continued on next page.

Continued from previous page.

Problem	Possible Cause	Confirmation	Correction	Reference
Servomotor Moves without a Reference Input	A failure occurred in the SERVOPACK.	–	Turn OFF the power supply to the servo system. Replace the SERVOPACK.	–
	The count-up direction of the linear encoder does not match the forward direction of the Moving Coil in the motor.	Check the directions.	Change the setting of Pn080 = n.□□X□ (Motor Phase Selection). Match the linear encoder direction and Servomotor direction.	page 5-21
	Polarity detection was not performed correctly.	Check to see if electrical angle 2 (electrical angle from polarity origin) at any position is between ±10°.	Correct the settings for the polarity detection-related parameters.	–
Dynamic Brake Does Not Operate	The setting of Pn001 = n.□□□X (Servo OFF or Alarm Group 1 Stopping Method) is not suitable.	Check the setting of Pn001 = n.□□□X.	Set Pn001 = n.□□□X correctly.	–
	The dynamic brake resistor is disconnected.	Check the moment of inertia, motor speed, and dynamic brake frequency of use. If the moment of inertia, motor speed, or dynamic brake frequency of use is excessive, the dynamic brake resistance may be disconnected.	Turn OFF the power supply to the servo system. Replace the SERVOPACK. To prevent disconnection, reduce the load.	–
	There was a failure in the dynamic brake drive circuit.	–	There is a defective component in the dynamic brake circuit. Turn OFF the power supply to the servo system. Replace the SERVOPACK.	–
Abnormal Noise from Servomotor	The Servomotor vibrated considerably while performing the tuning-less function with the default settings.	Check the waveform of the motor speed.	Reduce the load so that the moment of inertia ratio or mass ratio is within the allowable value, or increase the load level or reduce the rigidity level in the tuning-less level settings. If the situation is not improved, disable the tuning-less function (i.e., set Pn170 to n.□□□0) and execute autotuning either with or without a host reference.	page 8-11

Continued on next page.

Continued from previous page.

Problem	Possible Cause	Confirmation	Correction	Reference
Abnormal Noise from Servomotor	The machine mounting is not secure.	Turn OFF the power supply to the servo system. Check to see if there are any loose mounting screws.	Tighten the mounting screws.	–
		Turn OFF the power supply to the servo system. Check to see if there is misalignment in the coupling.	Align the coupling.	–
		Turn OFF the power supply to the servo system. Check to see if the coupling is balanced.	Balance the coupling.	–
	The bearings are defective.	Turn OFF the power supply to the servo system. Check for noise and vibration around the bearings.	Replace the Servomotor.	–
	There is a vibration source at the driven machine.	Turn OFF the power supply to the servo system. Check for any foreign matter, damage, or deformation in the machine's moving parts.	Consult with the machine manufacturer.	–
	Noise interference occurred because of incorrect I/O signal cable specifications.	Turn OFF the power supply to the servo system. Check the I/O signal cables to see if they satisfy specifications. Use shielded twisted-pair wire cables or screened twisted-pair cables with conductors of at least 0.12 mm ² .	Use cables that satisfy the specifications.	–
Noise interference occurred because an I/O signal cable is too long.	Turn OFF the power supply to the servo system. Check the lengths of the I/O signal cables.	The I/O signal cables must be no longer than 3 m.	–	
Noise interference occurred because of incorrect Encoder Cable specifications.	Turn OFF the power supply to the servo system. Check the Encoder Cable to see if it satisfies specifications. Use shielded twisted-pair cables or screened twisted-pair cables with conductors of at least 0.12 mm ² (stranded wire).	Use cables that satisfy the specifications.	–	

Continued on next page.

Continued from previous page.

Problem	Possible Cause	Confirmation	Correction	Reference
Abnormal Noise from Servomotor	Noise interference occurred because the Encoder Cable is too long.	Turn OFF the power supply to the servo system. Check the length of the Encoder Cable.	<ul style="list-style-type: none"> Rotary Servomotors: The Encoder Cable length must be 50 m max. Linear Servomotors: Make sure that the Serial Converter Unit cable is no longer than 20 m and that the Linear Encoder Cable and the Sensor Cable are no longer than 15 m each. 	—
	Noise interference occurred because the Encoder Cable is damaged.	Turn OFF the power supply to the servo system. Check the Encoder Cable to see if it is pinched or the sheath is damaged.	Replace the Encoder Cable and correct the cable installation environment.	—
	The Encoder Cable was subjected to excessive noise interference.	Turn OFF the power supply to the servo system. Check to see if the Encoder Cable is bundled with a high-current line or installed near a high-current line.	Correct the cable layout so that no surge is applied by high-current lines.	—
	There is variation in the FG potential because of the influence of machines on the Servomotor side, such as a welder.	Turn OFF the power supply to the servo system. Check to see if the machines are correctly grounded.	Properly ground the machines to separate them from the FG of the encoder.	—
	There is a SERVOPACK pulse counting error due to noise.	Check to see if there is noise interference on the signal line from the encoder.	Turn OFF the power supply to the servo system. Implement counter-measures against noise for the encoder wiring.	—
	The encoder was subjected to excessive vibration or shock.	Turn OFF the power supply to the servo system. Check to see if vibration from the machine occurred. Check the Servomotor installation (mounting surface precision, securing state, and alignment). Check the linear encoder installation (mounting surface precision and securing method).	Reduce machine vibration. Improve the mounting state of the Servomotor or linear encoder.	—
	A failure occurred in the encoder.	—	Turn OFF the power supply to the servo system. Replace the Servomotor.	—
	A failure occurred in the Serial Converter Unit.	—	Turn OFF the power supply to the servo system. Replace the Serial Converter Unit.	—
	A failure occurred in the linear encoder.	—	Turn OFF the power supply to the servo system. Replace the linear encoder.	—

Continued on next page.

Continued from previous page.

Problem	Possible Cause	Confirmation	Correction	Reference
Servomotor Vibrates at Frequency of Approx. 200 to 400 Hz.	The servo gains are not balanced.	Check to see if the servo gains have been correctly tuned.	Perform autotuning without a host reference.	page 8-23
	The setting of Pn100 (Speed Loop Gain) is too high.	Check the setting of Pn100. The default setting is Kv = 40.0 Hz.	Set Pn100 to an appropriate value.	—
	The setting of Pn102 (Position Loop Gain) is too high.	Check the setting of Pn102. The default setting is Kp = 40.0/s.	Set Pn102 to an appropriate value.	—
	The setting of Pn101 (Speed Loop Integral Time Constant) is not appropriate.	Check the setting of Pn101. The default setting is Ti = 20.0 ms.	Set Pn101 to an appropriate value.	—
	The setting of Pn103 (Moment of Inertia Ratio or Mass Ratio) is not appropriate.	Check the setting of Pn103.	Set Pn103 to an appropriate value.	—
Large Motor Speed Overshoot on Starting and Stopping	The servo gains are not balanced.	Check to see if the servo gains have been correctly tuned.	Perform autotuning without a host reference.	page 8-23
	The setting of Pn100 (Speed Loop Gain) is too high.	Check the setting of Pn100. The default setting is Kv = 40.0 Hz.	Set Pn100 to an appropriate value.	—
	The setting of Pn102 (Position Loop Gain) is too high.	Check the setting of Pn102. The default setting is Kp = 40.0/s.	Set Pn102 to an appropriate value.	—
	The setting of Pn101 (Speed Loop Integral Time Constant) is not appropriate.	Check the setting of Pn101. The default setting is Ti = 20.0 ms.	Set Pn101 to an appropriate value.	—
	The setting of Pn103 (Moment of Inertia Ratio or Mass Ratio) is not appropriate.	Check the setting of Pn103.	Set Pn103 to an appropriate value.	—
	The torque reference is saturated.	Check the waveform of the torque reference.	Use the mode switch.	—
	The force limits (Pn483 and Pn484) are set to the default values.	The default values of the force limits and Pn483 = 30% and Pn484 = 30%.	Set Pn483 and Pn484 to appropriate values.	page 6-22

Continued on next page.

Continued from previous page.

Problem	Possible Cause	Confirmation	Correction	Reference
Absolute Encoder Position Deviation Error (The position that was saved in the host controller when the power was turned OFF is different from the position when the power was next turned ON.)	Noise interference occurred because of incorrect Encoder Cable specifications.	Turn OFF the power supply to the servo system. Check the Encoder Cable to see if it satisfies specifications. Use a shielded twisted-pair wire cable or a screened twisted-pair cable with conductors of at least 0.12 mm ² .	Use cables that satisfy the specifications.	—
	Noise interference occurred because the Encoder Cable is too long.	Turn OFF the power supply to the servo system. Check the length of the Encoder Cable.	<ul style="list-style-type: none"> Rotary Servomotors: The Encoder Cable length must be 50 m max. Linear Servomotors: Make sure that the Serial Converter Unit cable is no longer than 20 m and that the Linear Encoder Cable and the Sensor Cable are no longer than 15 m each. 	—
	Noise interference occurred because the Encoder Cable is damaged.	Turn OFF the power supply to the servo system. Check the Encoder Cable to see if it is pinched or the sheath is damaged.	Replace the Encoder Cable and correct the cable installation environment.	—
	The Encoder Cable was subject to excessive noise interference.	Turn OFF the power supply to the servo system. Check to see if the Encoder Cable is bundled with a high-current line or installed near a high-current line.	Correct the cable layout so that no surge is applied by high-current lines.	—
	There is variation in the FG potential because of the influence of machines on the Servomotor side, such as a welder.	Turn OFF the power supply to the servo system. Check to see if the machines are correctly grounded.	Properly ground the machines to separate them from the FG of the encoder.	—
	There is a SERVOPACK pulse counting error due to noise.	Turn OFF the power supply to the servo system. Check to see if there is noise interference on the I/O signal line from the encoder or Serial Converter Unit.	Implement countermeasures against noise for the encoder or Serial Converter Unit wiring.	—
	The encoder was subjected to excessive vibration or shock.	Turn OFF the power supply to the servo system. Check to see if vibration from the machine occurred. Check the Servomotor installation (mounting surface precision, securing state, and alignment). Check the linear encoder installation (mounting surface precision and securing method).	Reduce machine vibration. Improve the mounting state of the Servomotor or linear encoder.	—

Continued on next page.

Continued from previous page.

Problem	Possible Cause	Confirmation	Correction	Reference
Absolute Encoder Position Deviation Error (The position that was saved in the host controller when the power was turned OFF is different from the position when the power was next turned ON.)	A failure occurred in the encoder.	–	Turn OFF the power supply to the servo system. Replace the Servomotor or linear encoder.	–
	A failure occurred in the SERVOPACK.	–	Turn OFF the power supply to the servo system. Replace the SERVOPACK.	–
Overtravel Occurred	The P-OT/N-OT (Forward Drive Prohibit or Reverse Drive Prohibit) signal was input.	Check the external power supply (+24 V) voltage for the input signals.	Correct the external power supply (+24 V) voltage for the input signals.	–
		Check the operating condition of the overtravel limit switches.	Make sure that the overtravel limit switches operate correctly.	–
		Check the wiring of the overtravel limit switches.	Correct the wiring of the overtravel limit switches.	page 5-27
		Check the settings of PnB0F and PnB10.	Set the parameters to correct values.	page 5-27
	The P-OT/N-OT (Forward Drive Prohibit or Reverse Drive Prohibit) signal malfunctioned.	Check for fluctuation in the external power supply (+24 V) voltage for the input signals.	Eliminate fluctuation from the external power supply (+24 V) voltage for the input signals.	–
		Check to see if the operation of the overtravel limit switches is unstable.	Stabilize the operating condition of the overtravel limit switches.	–
		Check the wiring of the overtravel limit switches (e.g., check for cable damage and loose screws).	Correct the wiring of the overtravel limit switches.	–
The selection of the Servomotor stopping method is not correct.	Check the servo OFF stopping method set in Pn001 = n.□□□X or PnB1F.	Select a Servomotor stopping method other than coasting to a stop.	page 5-28	
Improper Stop Position for Overtravel (OT) Signal	The limit switch position and dog length are not appropriate.	–	Install the limit switch at the appropriate position.	–
	The overtravel limit switch position is too close for the coasting distance.	–	Install the overtravel limit switch at the appropriate position.	–

Continued on next page.

Continued from previous page.

Problem	Possible Cause	Confirmation	Correction	Reference
Position Deviation (without Alarm)	Noise interference occurred because of incorrect Encoder Cable specifications.	Turn OFF the power supply to the servo system. Check the Encoder Cable to see if it satisfies specifications. Use a shielded twisted-pair wire cable or a screened twisted-pair cable with conductors of at least 0.12 mm ² .	Use cables that satisfy the specifications.	–
	Noise interference occurred because the Encoder Cable is too long.	Turn OFF the power supply to the servo system. Check the length of the Encoder Cable.	<ul style="list-style-type: none"> Rotary Servomotors: The Encoder Cable length must be 50 m max. Linear Servomotors: Make sure that the Serial Converter Unit cable is no longer than 20 m and that the Linear Encoder Cable and the Sensor Cable are no longer than 15 m each. 	–
	Noise interference occurred because the Encoder Cable is damaged.	Turn OFF the power supply to the servo system. Check the Encoder Cable to see if it is pinched or the sheath is damaged.	Replace the Encoder Cable and correct the cable installation environment.	–
	The Encoder Cable was subjected to excessive noise interference.	Turn OFF the power supply to the servo system. Check to see if the Encoder Cable is bundled with a high-current line or installed near a high-current line.	Correct the cable layout so that no surge is applied by high-current lines.	–
	There is variation in the FG potential because of the influence of machines on the Servomotor side, such as a welder.	Turn OFF the power supply to the servo system. Check to see if the machines are correctly grounded.	Properly ground the machines to separate them from the FG of the encoder.	–
	There is a SERVOPACK pulse counting error due to noise.	Turn OFF the power supply to the servo system. Check to see if there is noise interference on the I/O signal line from the encoder or Serial Converter Unit.	Implement counter-measures against noise for the encoder wiring or Serial Converter Unit wiring.	–

Continued on next page.

Continued from previous page.

Problem	Possible Cause	Confirmation	Correction	Reference
Position Deviation (without Alarm)	The encoder was subjected to excessive vibration or shock.	Turn OFF the power supply to the servo system. Check to see if vibration from the machine occurred. Check the Servomotor installation (mounting surface precision, securing state, and alignment). Check the linear encoder installation (mounting surface precision and securing method).	Reduce machine vibration. Improve the mounting state of the Servomotor or linear encoder.	—
	The coupling between the machine and Servomotor is not suitable.	Turn OFF the power supply to the servo system. Check to see if position offset occurs at the coupling between machine and Servomotor.	Correctly secure the coupling between the machine and Servomotor.	—
	Noise interference occurred because of incorrect I/O signal cable specifications.	Turn OFF the power supply to the servo system. Check the I/O signal cables to see if they satisfy specifications. Use a shielded twisted-pair wire cable or a screened twisted-pair cable with conductors of at least 0.12 mm ² .	Use cables that satisfy the specifications.	—
	Noise interference occurred because an I/O signal cable is too long.	Turn OFF the power supply to the servo system. Check the lengths of the I/O signal cables.	The I/O signal cables must be no longer than 3 m.	—
	An encoder fault occurred. (The pulse count does not change.)	—	Turn OFF the power supply to the servo system. Replace the Servomotor or linear encoder.	—
	A failure occurred in the SERVOPACK.	—	Turn OFF the power supply to the servo system. Replace the SERVOPACK.	—
Servomotor Overheated	The surrounding air temperature is too high.	Measure the surrounding air temperature around the Servomotor.	Reduce the surrounding air temperature to 40°C or less.	—
	The surface of the Servomotor is dirty.	Turn OFF the power supply to the servo system. Visually check the surface for dirt.	Clean dirt, dust, and oil from the surface.	—
	There is an overload on the Servomotor.	Check the load status with a monitor.	If the Servomotor is overloaded, reduce the load or replace the Servo Drive with a SERVOPACK and Servomotor with larger capacities.	—
	Polarity detection was not performed correctly.	Check to see if electrical angle 2 (electrical angle from polarity origin) at any position is between ±10°.	Correct the settings for the polarity detection-related parameters.	—

Parameter Lists

16

This chapter provides information on the parameters.

16.1	Parameter Configurations	16-2
16.2	List of Parameters	16-3
16.2.1	Interpreting the Parameter Lists	16-3
16.2.2	List of Parameters	16-4
16.3	Parameter Recording Table	16-31

16.1 Parameter Configurations

Parameters are comprised of the types shown in the following table.

Type	Parameter No.	Parameter No.
Function Selection Parameters	Pn000 to Pn081 PnB1F	Select basic and application functions such as the type of control mode or the stop method when an alarm occurs.
Servo Gain and Other Parameters	Pn100 to Pn170	Set numerical values such as speed and position loop gains.
Position Control Parameters	Pn205 to Pn217	Set position control parameters such as average movement time.
Speed Control Parameters	Pn304 to Pn324	Set speed control parameters such as the speed feedback filter.
Torque Control Parameters	Pn401 to Pn460	Set torque control parameters such as the torque limit values.
Sequence Parameters	Pn502 to Pn561 PnB03 to PnB1E PnB4F PnB51 to PnB52	Set conditions for the sequence I/O signals.
Positioning Parameters	PnB20 to PnB2F PnB50	Set parameters related to positioning.
Homing Parameters	PnB31 to PnB39	Set parameters related to homing.
Others	Pn600 to Pn604	Set other parameters.
Serial Communications Parameters	PnB00 to PnB02	Set parameters related to serial communications (CN12).
Setup Information Parameters	PnB3B to PnB4D	Do not change these parameters. These are reserved parameters.
Fully-closed Loop Control Parameters	Pn20A, Pn22A, Pn281 Pn51B, Pn52A	Set parameters related to fully-closed loop control.
Linear Servomotor Parameters	Pn080 Pn181 to Pn182 Pn281 to Pn282 Pn383 to Pn385 Pn480 to Pn49F Pn581 to Pn587	Set parameters related to linear servomotors.

16.2 List of Parameters

16.2.1 Interpreting the Parameter Lists

The types of Servomotors to which the parameter applies.

- All: The parameter is used for both Rotary Servomotors and Linear Servomotors.
- Rotary: The parameter is used for only Rotary Servomotors.
- Linear: The parameter is used for only Linear Servomotors.

Rotary Servomotor terms are used for parameters that are applicable to all Servomotors. If you are using a Linear Servomotor, you need to interpret the terms accordingly. Refer to the following section for details.

◆ Differences in Terms for Rotary Servomotors and Linear Servomotors on page xi

Indicates when a change to the parameter will be effective.

Parameter No.	Size	Name	Setting Range	Setting Unit	Default Setting	Applicable Motors	When Enabled	Classification	Reference	
Pn000	2	Basic Function Selections 0	0000h to 10B1h	–	0000h	All	After restart	Setup	–	
			<p>If there are differences in the parameters for Rotary Servomotor and Linear Servomotor, information is provided for both.</p> <ul style="list-style-type: none"> • Top row: For Rotary Servomotors • Bottom row: For Linear Servomotors 				<p>There are the following two classifications.</p> <ul style="list-style-type: none"> • Setup • Tuning <p>Refer to the following section for details.</p> <p> 5.1.1 Parameter Classification on page 5-3</p>			
			<p>Rotation Direction Selection</p> <p>Movement Direction Selection</p>				Reference			
	n.□□□X		0	Use CCW as the forward direction.			page 5-15			
				Use the direction in which the linear encoder counts up as the forward direction.						
			1	Use CW as the forward direction. (Reverse Rotation Mode)						
				Use the direction in which the linear encoder counts down as the forward direction. (Reverse Movement Mode)						
	n.□□X□		Reserved parameter (Do not change.)							
	n.□X□□		Reserved parameter (Do not change.)							
			<p>Rotary/Linear Servomotor Startup Selection When Encoder Is Not Connected</p>				Reference			
n.X□□□		0	When an encoder is not connected, start as SERVOPACK for Rotary Servomotor.			page 5-14				
		1	When an encoder is not connected, start as SERVOPACK for Linear Servomotor.							

16.2.2 List of Parameters

The following table lists the parameters.

Note: Do not change the following parameters from their default settings.

- Reserved parameters
- Parameters not given in this manual
- Parameters that are not valid for the Servomotor that you are using, as given in the parameter table



Note

- The following parameters will be set automatically when the INDEXER Module is mounted. Do not change the settings of these parameters.
Pn002 = n.□□□X, Pn205, Pn207 = n.X□□□, Pn50A to Pn512, Pn517, and Pn522
- Parameters that are unique to the INDEXER Module will be set automatically the first time the power supply is turned on after the INDEXER Module is mounted. Up to 10 s may be required for the SERVOPACK to start.

Parameter No.	Bit No.	Name	Setting Range	Setting Unit	Default Setting	Applicable Motors	When Enabled	Classification	Reference											
Pn000	2	Basic Function Selections 0	0000h to 10B1h	–	0000h	All	After restart	Setup	–											
	n.□□□X	<table border="1" style="width: 100%;"> <tr> <th colspan="2">Rotation Direction Selection</th> <th rowspan="2">Reference</th> </tr> <tr> <th colspan="2">Movement Direction Selection</th> </tr> <tr> <td rowspan="2">0</td> <td>Use CCW as the forward direction.</td> <td rowspan="4">page 5-15</td> </tr> <tr> <td>Use the direction in which the linear encoder counts up as the forward direction.</td> </tr> <tr> <td rowspan="2">1</td> <td>Use CW as the forward direction. (Reverse Rotation Mode)</td> </tr> <tr> <td>Use the direction in which the linear encoder counts down as the forward direction. (Reverse Movement Mode)</td> </tr> </table>							Rotation Direction Selection		Reference	Movement Direction Selection		0	Use CCW as the forward direction.	page 5-15	Use the direction in which the linear encoder counts up as the forward direction.	1	Use CW as the forward direction. (Reverse Rotation Mode)	Use the direction in which the linear encoder counts down as the forward direction. (Reverse Movement Mode)
		Rotation Direction Selection		Reference																
		Movement Direction Selection																		
		0	Use CCW as the forward direction.	page 5-15																
	Use the direction in which the linear encoder counts up as the forward direction.																			
	1	Use CW as the forward direction. (Reverse Rotation Mode)																		
		Use the direction in which the linear encoder counts down as the forward direction. (Reverse Movement Mode)																		
	n.□□X□	Reserved parameter (Do not change.)																		
	n.□X□□	Reserved parameter (Do not change.)																		
n.X□□□	<table border="1" style="width: 100%;"> <tr> <th colspan="2">Rotary/Linear Servomotor Startup Selection When Encoder Is Not Connected</th> <th rowspan="2">Reference</th> </tr> <tr> <td>0</td> <td>When an encoder is not connected, start as SERVOPACK for Rotary Servomotor.</td> </tr> <tr> <td>1</td> <td>When an encoder is not connected, start as SERVOPACK for Linear Servomotor.</td> </tr> </table>							Rotary/Linear Servomotor Startup Selection When Encoder Is Not Connected		Reference	0	When an encoder is not connected, start as SERVOPACK for Rotary Servomotor.	1	When an encoder is not connected, start as SERVOPACK for Linear Servomotor.	page 5-14					
	Rotary/Linear Servomotor Startup Selection When Encoder Is Not Connected		Reference																	
0	When an encoder is not connected, start as SERVOPACK for Rotary Servomotor.																			
1	When an encoder is not connected, start as SERVOPACK for Linear Servomotor.																			

Continued on next page.

Continued from previous page.

Parameter No.	Size	Name	Setting Range	Setting Unit	Default Setting	Applicable Motors	When Enabled	Classification	Reference
Pn001	2	Application Function Selections 1	0000h to 1142h	–	0000h	All	After restart	Setup	–
	n.□□□X	Motor Stopping Method for Servo OFF and Group 1 Alarms							Reference
		0	Stop the motor by applying the dynamic brake.						page 5-35
		1	Stop the motor by the applying dynamic brake and then release the dynamic brake.						
	2	Coast the motor to a stop without the dynamic brake.							
	n.□□X□	Reserved parameter (Do not change.)							
	n.□X□□	Main Circuit Power Supply AC/DC Input Selection							Reference
		0	Input AC power as the main circuit power supply using the L1, L2, and L3 terminals (do not use shared converter).						page 5-12
	1	Input DC power as the main circuit power supply using the B1/⊕ and ⊖ 2 terminals or the B1 and ⊖ 2 terminals (use an external converter or the shared converter).							
	n.X□□□	Warning Code Output Selection							Reference
0		Output only alarm codes on the /ALO1 to /ALO3 terminals.						page 6-8	
1	Output both warning codes and alarm codes on the /ALO1 to /ALO3 terminals. If there is an alarm, the alarm code is output.								
Pn002	2	Application Function Selections 2	0000h to 4213h	–	0000h*1	–	After restart	Setup	–
	n.□□□X	Reserved parameter (Do not change.)							
	n.□□X□	Reserved parameter (Do not change.)							
	n.□X□□	Encoder Usage					Applicable Motors	Reference	
		0	Use the encoder according to encoder specifications.				All	page 6-23	
		1	Use the encoder as an incremental encoder.						
	2	Use the encoder as a single-turn absolute encoder.				Rotary			
	n.X□□□	External Encoder Usage					Applicable Motors	Reference	
		0	Do not use an external encoder.				Rotary	page 10-6	
		1	The external encoder moves in the forward direction for CCW motor rotation.						
2		Reserved parameter (Do not change.)							
3		The external encoder moves in the reverse direction for CCW motor rotation.							
4	Reserved parameter (Do not change.)								

Continued on next page.

Continued from previous page.

Parameter No.	Size	Name	Setting Range	Setting Unit	Default Setting	Applicable Motors	When Enabled	Classification	Reference	
Pn006	2	Application Function Selections 6	0000h to 105Fh	–	0002h	All	Immediately	Setup	page 9-10	
	n.□□XX	Analog Monitor 1 Signal Selection								
		00	Motor speed (1 V/1,000 min ⁻¹)							
			Motor speed (1 V/1,000 mm/s)							
		01	Speed reference (1 V/1,000 min ⁻¹)							
			Speed reference (1 V/1,000 mm/s)							
		02	Torque reference (1 V/100% rated torque)							
			Force reference (1 V/100% rated force)							
		03	Position deviation (0.05 V/reference unit)							
		04	Position amplifier deviation (after electronic gear) (0.05 V/encoder pulse unit)							
			Position amplifier deviation (after electronic gear) (0.05 V/linear encoder pulse unit)							
		05	Position reference speed (1 V/1,000 min ⁻¹)							
			Position reference speed (1 V/1,000 mm/s)							
		06	Reserved parameter (Do not change.)							
		07	Load-motor position deviation (0.01 V/reference unit)							
		08	Positioning completion (positioning completed: 5 V, positioning not completed: 0 V)							
		09	Speed feedforward (1 V/1,000 min ⁻¹)							
			Speed feedforward (1 V/1,000 mm/s)							
		0A	Torque feedforward (1 V/100% rated torque)							
			Force feedforward (1 V/100% rated force)							
		0B	Active gain (1st gain: 1 V, 2nd gain: 2 V)							
		0C	Completion of position reference distribution (completed: 5 V, not completed: 0 V)							
		0D	External encoder speed (1 V/1,000 min ⁻¹ : value at the motor shaft)							
		0E	Reserved parameter (Do not change.)							
		0F	Reserved parameter (Do not change.)							
		10	Main circuit DC voltage							
		11 to 5F	Reserved parameters (Do not change.)							
		n.□□□□	Reserved parameter (Do not change.)							
n.X□□□		Reserved parameter (Do not change.)								

Continued on next page.

Continued from previous page.

Parameter No.	Size	Name	Setting Range	Setting Unit	Default Setting	Applicable Motors	When Enabled	Classification	Reference	
Pn007	2	Application Function Selections 7	0000h to 105Fh	–	0000h	All	Immediately	Setup	page 9-10	
	n.□□XX	Analog Monitor 2 Signal Selection								
		00	Motor speed (1 V/1,000 min ⁻¹)							
			Motor speed (1 V/1,000 mm/s)							
		01	Speed reference (1 V/1,000 min ⁻¹)							
			Speed reference (1 V/1,000 mm/s)							
		02	Torque reference (1 V/100% rated torque)							
			Force reference (1 V/100% rated force)							
		03	Position deviation (0.05 V/reference unit)							
		04	Position amplifier deviation (after electronic gear) (0.05 V/encoder pulse unit)							
			Position amplifier deviation (after electronic gear) (0.05 V/linear encoder pulse unit)							
		05	Position reference speed (1 V/1,000 min ⁻¹)							
			Position reference speed (1 V/1,000 mm/s)							
		06	Reserved parameter (Do not change.)							
		07	Load-motor position deviation (0.01 V/reference unit)							
		08	Positioning completion (positioning completed: 5 V, positioning not completed: 0 V)							
		09	Speed feedforward (1 V/1,000 min ⁻¹)							
			Speed feedforward (1 V/1,000 mm/s)							
		0A	Torque feedforward (1 V/100% rated torque)							
			Force feedforward (1 V/100% rated force)							
		0B	Active gain (1st gain: 1 V, 2nd gain: 2 V)							
		0C	Completion of position reference distribution (completed: 5 V, not completed: 0 V)							
		0D	External encoder speed (1 V/1,000 min ⁻¹ : value at the motor shaft)							
		0E	Reserved parameter (Do not change.)							
		0F	Reserved parameter (Do not change.)							
		10	Main circuit DC voltage							
		11 to 5F	Reserved parameters (Do not change.)							
		n.□X□□	Reserved parameter (Do not change.)							
		n.X□□□	Reserved parameter (Do not change.)							

Continued on next page.

Continued from previous page.

Parameter No.	Size	Name	Setting Range	Setting Unit	Default Setting	Applicable Motors	When Enabled	Classification	Reference	
Pn008	2	Application Function Selections 8	0000h to 7121h	–	4000h	Rotary	After restart	Setup	–	
	n.□□□X		Low Battery Voltage Alarm/Warning Selection						Reference	
		0	Output alarm (A.830) for low battery voltage.						page 15-2	
		1	Output warning (A.930) for low battery voltage.							
	n.□□X□		Function Selection for Undervoltage						Reference	
		0	Do not detect undervoltage.						page 6-12	
		1	Detect undervoltage warning and limit torque at host controller.							
		2	Detect undervoltage warning and limit torque with Pn424 and Pn425 (i.e., only in SERVOPACK).							
	n.□X□□		Warning Detection Selection						Reference	
		0	Detect warnings.						page 15-57	
	1	Do not detect warnings except for A.971.								
n.X□□□		Reserved parameter (Do not change.)								
Pn009	2	Application Function Selections 9	0000h to 0121h	–	0010h	All	After restart	Tuning	–	
	n.□□□X		Reserved parameter (Do not change.)							
	n.□□X□		Current Control Mode Selection						Reference	
		1	<ul style="list-style-type: none"> SERVOPACK Models SGD7S-R70A, -R90A, -1R6A, -2R8A, -3R8A, -5R5A, and -7R6A: Use current control mode 1. SERVOPACK Models SGD7S-120A, -180A, -200A, -330A, -470A, -550A, -590A, and -780A: Use current control mode 2. 						page 8-70	
		2	Use current control mode 2.							
	n.□X□□		Speed Detection Method Selection						Reference	
		0	Use speed detection 1.						page 8-71	
		1	Use speed detection 2.							
	n.X□□□		Reserved parameter (Do not change.)							

Continued on next page.

Continued from previous page.

Parameter No.	Size	Name	Setting Range	Setting Unit	Default Setting	Applicable Motors	When Enabled	Classification	Reference	
Pn00A	2	Application Function Selections A	0000h to 1044h	–	0001h	All	After restart	Setup	–	
			Motor Stopping Method for Group 2 Alarms							Reference
	n.□□□X		0	Apply the dynamic brake or coast the motor to a stop (use the stopping method set in Pn001 = n.□□□X).						page 5-36
			1	Decelerate the motor to a stop using the torque set in Pn406 as the maximum torque. Use the setting of Pn001 = n.□□□X for the status after stopping.						
			2	Decelerate the motor to a stop using the torque set in Pn406 as the maximum torque and then let the motor coast.						
			3	Decelerate the motor to a stop using the deceleration time set in Pn30A. Use the setting of Pn001 = n.□□□X for the status after stopping.						
			4	Decelerate the motor to a stop using the deceleration time set in Pn30A and then let the motor coast.						
	n.□□X□		Reserved parameter (Do not change.)							
	n.□X□□		Reserved parameter (Do not change.)							
	n.X□□□		Reserved parameter (Do not change.)							
Pn00B	2	Application Function Selections B	0000h to 1121h	–	0000h	All	After restart	Setup	–	
	n.□□□X		Operator Parameter Display Selection							Reference
			0	Display only setup parameters.						page 5-3
			1	Display all parameters.						
	n.□□X□		Motor Stopping Method for Group 2 Alarms							Reference
			0	Stop the motor by setting the speed reference to 0.						page 5-36
			1	Apply the dynamic brake or coast the motor to a stop (use the stopping method set in Pn001 = n.□□□X).						
			2	Set the stopping method with Pn00A = n.□□□X.						
	n.□X□□		Power Input Selection for Three-phase SERVOPACK							Reference
			0	Use a three-phase power supply input.						page 5-13
		1	Use a three-phase power supply input and as a single-phase power supply input.							
n.X□□□		Reserved parameter (Do not change.)								

Continued on next page.

Continued from previous page.

Parameter No.	Size	Name	Setting Range	Setting Unit	Default Setting	Applicable Motors	When Enabled	Classification	Reference	
Pn00C	2	Application Function Selections C	0000h to 0131h	–	0000h	–	After restart	Setup	page 7-21	
	n.□□□X		Function Selection for Test without a Motor						Applicable Motors	
			0	Disable tests without a motor.					All	
			1	Enable tests without a motor.						
	n.□□X□		Encoder Resolution for Tests without a Motor						Applicable Motors	
			0	Use 13 bits.					Rotary	
			1	Use 20 bits.						
			2	Use 22 bits.						
			3	Use 24 bits.						
	n.□X□□		Encoder Type Selection for Tests without a Motor						Applicable Motors	
		0	Use an incremental encoder.					All		
		1	Use an absolute encoder.							
n.X□□□		Reserved parameter (Do not change.)								
Pn00D	2	Application Function Selections D	0000h to 2001h	–	0000h	All	Immediately	Setup	–	
	n.□□□X		Stand-alone Mode (Test Operation) Selection							
			0	Enable connection with the Command Option Module.						
			1	Disable connection with the Command Option Module.						
	n.□□X□		Reserved parameter (Do not change.)							
	n.□X□□		Reserved parameter (Do not change.)							
	n.X□□□		Overtravel Warning Detection Selection						Reference	
			0	Do not detect overtravel warnings.					page 5-29	
			1	Detect overtravel warnings.						
			2	Reserved parameter (Do not change.)						
Pn00E	2	Reserved parameter (Do not change.)	–	–	0000h	All	–	–	–	
Pn00F	2	Application Function Selections F	0000h to 2011h	–	0000h	All	After restart	Setup	–	
	n.□□□X		Preventative Maintenance Warning Selection						Reference	
			0	Do not detect preventative maintenance warnings.					page 9-16	
			1	Detect preventative maintenance warnings.						
	n.□□X□		Reserved parameter (Do not change.)							
	n.□X□□		Reserved parameter (Do not change.)							
	n.X□□□		Reserved parameter (Do not change.)							
Pn010	2	Axis Address Selection (For UART/USB communications)	0000h to 007Fh	–	0001h	All	After restart	Setup	–	
Pn021	2	Reserved parameter (Do not change.)	–	–	0000h	All	–	–	–	

Continued on next page.

Continued from previous page.

Parameter No.	Size	Name	Setting Range	Setting Unit	Default Setting	Applicable Motors	When Enabled	Classification	Reference	
Pn022	2	Reserved parameter (Do not change.)	–	–	0000h	All	–	–	–	
Pn040	2	Σ-V Compatible Function Switch	0000h to 2111h	–	0000h	–	After restart	Setup	–	
	n.□□□X		Reserved parameter (Do not change.)							
	n.□□□□		Encoder Resolution Compatibility Selection						Applicable Motors	
			0	Use the encoder resolution of the Servomotor.					Rotary	
			1	Use a resolution of 20 bits when connected to an SGM7J, SGM7A, SGM7P, SGM7G, SGM7E, or SGM7F Servomotor.						
n.□X□□		Reserved parameter (Do not change.)								
n.X□□□		Reserved parameter (Do not change.)								
Pn080	2	Application Function Selections 80	0000h to 1111h	–	0000h	Linear	After restart	Setup	–	
	n.□□□X		Polarity Sensor Selection						Reference	
			0	Use polarity sensor.					page 5-23	
			1	Do not use polarity sensor.						
	n.□□X□		Motor Phase Sequence Selection						Reference	
		0	Set a phase-A lead as a phase sequence of U, V, and W.					page 5-21		
		1	Set a phase-B lead as a phase sequence of U, V, and W.							
n.□X□□		Reserved parameter (Do not change.)								
n.X□□□		Calculation Method for Maximum Speed or Encoder Output Pulses						Reference		
		0	Calculate the encoder output pulse setting for a fixed maximum speed.					page 17-4		
		1	Calculate the maximum speed for a fixed encoder output pulse setting.							
Pn081	2	Application Function Selections 81	0000h to 1111h	–	0000h	All	After restart	Setup	page 6-17	
	n.□□□X		Phase-C Pulse Output Selection							
			0	Output phase-C pulses only in the forward direction.						
			1	Output phase-C pulses in both the forward and reverse directions.						
	n.□□X□		Reserved parameter (Do not change.)							
n.□X□□		Reserved parameter (Do not change.)								
n.X□□□		Reserved parameter (Do not change.)								
Pn100	2	Speed Loop Gain	10 to 20,000	0.1 Hz	400	All	Immediately	Tuning	page 8-73	
Pn101	2	Speed Loop Integral Time Constant	15 to 51,200	0.01 ms	2000	All	Immediately	Tuning	page 8-73	
Pn102	2	Position Loop Gain	10 to 20,000	0.1/s	400	All	Immediately	Tuning	page 8-73	
Pn103	2	Moment of Inertia Ratio	0 to 20,000	1%	100	All	Immediately	Tuning	page 8-73	
Pn104	2	Second Speed Loop Gain	10 to 20,000	0.1 Hz	400	All	Immediately	Tuning	page 8-64	

Continued on next page.

16.2 List of Parameters

16.2.2 List of Parameters

Continued from previous page.

Parameter No.	Size	Name	Setting Range	Setting Unit	Default Setting	Applicable Motors	When Enabled	Classification	Reference	
Pn105	2	Second Speed Loop Integral Time Constant	15 to 51,200	0.01 ms	2000	All	Immediately	Tuning	page 8-64	
Pn106	2	Second Position Loop Gain	10 to 20,000	0.1/s	400	All	Immediately	Tuning	page 8-64	
Pn109	2	Feedforward	0 to 100	1%	0	All	Immediately	Tuning	page 8-84	
Pn10A	2	Feedforward Filter Time Constant	0 to 6,400	0.01 ms	0	All	Immediately	Tuning	page 8-84	
Pn10B	2	Gain Application Selections	0000h to 5334h	–	0000h	All	–	Setup	–	
	n.□□□X	Mode Switching Selection						When Enabled	Reference	page 8-84
		0	Use the internal torque reference as the condition (level setting: Pn10C).					Immediately		
		1	Use the speed reference as the condition (level setting: Pn10D).							
			Use the speed reference as the condition (level setting: Pn181).							
		2	Use the acceleration reference as the condition (level setting: Pn10E).							
			Use the acceleration reference as the condition (level setting: Pn182).							
	3	Use the position deviation as the condition (level setting: Pn10F).								
	4	Do not use mode switching.								
	n.□□□□	Speed Loop Control Method						When Enabled	Reference	page 8-79
0		PI control					After restart			
1		I-P control								
2, 3		Reserved parameters (Do not change.)								
n.□X□□	Reserved parameter (Do not change.)									
n.X□□□	Reserved parameter (Do not change.)									
Pn10C	2	Mode Switching Level for Torque Reference	0 to 800	1%	200	All	Immediately	Tuning	page 8-84	
Pn10D	2	Mode Switching Level for Speed Reference	0 to 10,000	1 min ⁻¹	0	Rotary	Immediately	Tuning	page 8-84	
Pn10E	2	Mode Switching Level for Acceleration	0 to 30,000	1 min ⁻¹ /s	0	Rotary	Immediately	Tuning	page 8-84	
Pn10F	2	Mode Switching Level for Position Deviation	0 to 10,000	1 reference unit	0	All	Immediately	Tuning	page 8-84	
Pn11F	2	Position Integral Time Constant	0 to 50,000	0.1 ms	0	All	Immediately	Tuning	page 8-87	
Pn121	2	Friction Compensation Gain	10 to 1,000	1%	100	All	Immediately	Tuning	page 8-64, page 8-67	
Pn122	2	Second Friction Compensation Gain	10 to 1,000	1%	100	All	Immediately	Tuning	page 8-64, page 8-67	
Pn123	2	Friction Compensation Coefficient	0 to 100	1%	0	All	Immediately	Tuning	page 8-67	
Pn124	2	Friction Compensation Frequency Correction	-10,000 to 10,000	0.1 Hz	0	All	Immediately	Tuning	page 8-67	
Pn125	2	Friction Compensation Gain Correction	1 to 1,000	1%	100	All	Immediately	Tuning	page 8-67	

Continued on next page.

Continued from previous page.

Parameter No.	Size	Name	Setting Range	Setting Unit	Default Setting	Applicable Motors	When Enabled	Classification	Reference
Pn131	2	Gain Switching Time 1	0 to 65,535	1 ms	0	All	Immediately	Tuning	page 8-64
Pn132	2	Gain Switching Time 2	0 to 65,535	1 ms	0	All	Immediately	Tuning	page 8-64
Pn135	2	Gain Switching Waiting Time 1	0 to 65,535	1 ms	0	All	Immediately	Tuning	page 8-64
Pn136	2	Gain Switching Waiting Time 2	0 to 65,535	1 ms	0	All	Immediately	Tuning	page 8-64
Pn139	2	Automatic Gain Switching Selections 1	0000h to 0052h	–	0000h	All	Immediately	Tuning	page 8-64
	n.□□□X	Gain Switching Selection							
		0	Disable automatic gain switching.						
		1	Reserved parameter (Do not change.)						
	n.□□□□	Gain Switching Condition A							
		0	/COIN (Positioning Completion Output) signal turns ON.						
		1	/COIN (Positioning Completion Output) signal turns OFF.						
2		/NEAR (Near Output) signal turns ON.							
3		/NEAR (Near Output) signal turns OFF.							
n.□□□□	4	Position reference filter output is 0 and position reference input is OFF.							
	5	Position reference input is ON.							
n.□□□□	Reserved parameter (Do not change.)								
n.X□□□	Reserved parameter (Do not change.)								
Pn13D	2	Current Gain Level	100 to 2,000	1%	2000	All	Immediately	Tuning	page 8-70
Pn140	2	Model Following Control-Related Selections	0000h to 1121h	–	0100h	All	Immediately	Tuning	–
	n.□□□X	Model Following Control Selection							Reference
		0	Do not use model following control.						page 8-81
	1	Use model following control.							
	n.□□□□	Vibration Suppression Selection							Reference
		0	Do not perform vibration suppression.						page 8-81
		1	Perform vibration suppression for a specific frequency.						
2	Perform vibration suppression for two specific frequencies.								
n.□□□□	Vibration Suppression Adjustment Selection							Reference	
	0	Do not adjust vibration suppression automatically during execution of autotuning without a host reference, autotuning with a host reference, and custom tuning.						page 8-32	
1	Adjust vibration suppression automatically during execution of autotuning without a host reference, autotuning with a host reference, and custom tuning.								
n.X□□□	Reserved parameter (Do not change.)								
Pn141	2	Model Following Control Gain	10 to 20,000	0.1/s	500	All	Immediately	Tuning	page 8-81
Pn142	2	Model Following Control Gain Correction	500 to 2,000	0.1%	1000	All	Immediately	Tuning	–

Continued on next page.

16.2 List of Parameters

16.2.2 List of Parameters

Continued from previous page.

Parameter No.	Size	Name	Setting Range	Setting Unit	Default Setting	Applicable Motors	When Enabled	Classification	Reference	
Pn143	2	Model Following Control Bias in the Forward Direction	0 to 10,000	0.1%	1000	All	Immediately	Tuning	page 8-81	
Pn144	2	Model Following Control Bias in the Reverse Direction	0 to 10,000	0.1%	1000	All	Immediately	Tuning	page 8-81	
Pn145	2	Vibration Suppression 1 Frequency A	10 to 2,500	0.1 Hz	500	All	Immediately	Tuning	page 8-57	
Pn146	2	Vibration Suppression 1 Frequency B	10 to 2,500	0.1 Hz	700	All	Immediately	Tuning	page 8-57	
Pn147	2	Model Following Control Speed Feedforward Compensation	0 to 10,000	0.1%	1000	All	Immediately	Tuning	page 8-81	
Pn148	2	Second Model Following Control Gain	10 to 20,000	0.1/s	500	All	Immediately	Tuning	–	
Pn149	2	Second Model Following Control Gain Correction	500 to 2,000	0.1%	1000	All	Immediately	Tuning	–	
Pn14A	2	Vibration Suppression 2 Frequency	10 to 2,000	0.1 Hz	800	All	Immediately	Tuning	page 8-57	
Pn14B	2	Vibration Suppression 2 Correction	10 to 1,000	1%	100	All	Immediately	Tuning	page 8-57	
Pn14F	2	Control-Related Selections	0000h to 0021h	–	0021h	All	After restart	Tuning	–	
	n.□□□X		Model Following Control Type Selection						Reference	
			0	Use model following control type 1.						page 8-83
			1	Use model following control type 2.						
	n.□□X□		Tuning-less Type Selection						Reference	
			0	Use tuning-less type 1.						page 8-12
		1	Use tuning-less type 2.							
		2	Use tuning-less type 3.							
n.□X□□		Reserved parameter (Do not change.)								
n.X□□□		Reserved parameter (Do not change.)								
Pn160	2	Anti-Resonance Control-Related Selections	0000h to 0011h	–	0010h	All	Immediately	Tuning	–	
	n.□□□X		Anti-Resonance Control Selection						Reference	
			0	Do not use anti-resonance control.						page 8-49
			1	Use anti-resonance control.						
	n.□□X□		Anti-Resonance Control Adjustment Selection						Reference	
			0	Do not adjust anti-resonance control automatically during execution of autotuning without a host reference, autotuning with a host reference, and custom tuning.						page 8-31
		1	Adjust anti-resonance control automatically during execution of autotuning without a host reference, autotuning with a host reference, and custom tuning.							
n.□X□□		Reserved parameter (Do not change.)								
n.X□□□		Reserved parameter (Do not change.)								
Pn161	2	Anti-Resonance Frequency	10 to 20,000	0.1 Hz	1000	All	Immediately	Tuning	page 8-49	
Pn162	2	Anti-Resonance Gain Correction	1 to 1,000	1%	100	All	Immediately	Tuning	page 8-49	

Continued on next page.

Continued from previous page.

Parameter No.	Size	Name	Setting Range	Setting Unit	Default Setting	Applicable Motors	When Enabled	Classification	Reference										
Pn163	2	Anti-Resonance Damping Gain	0 to 300	1%	0	All	Immediately	Tuning	page 8-49										
Pn164	2	Anti-Resonance Filter Time Constant 1 Correction	-1,000 to 1,000	0.01 ms	0	All	Immediately	Tuning	page 8-49										
Pn165	2	Anti-Resonance Filter Time Constant 2 Correction	-1,000 to 1,000	0.01 ms	0	All	Immediately	Tuning	page 8-49										
Pn166	2	Anti-Resonance Damping Gain 2	0 to 1,000	1%	0	All	Immediately	Tuning	page 8-52										
Pn170	2	Tuning-less Function-Related Selections	0000h to 2711h	–	1401h	All	–	Setup	page 8-11										
		<table border="1"> <thead> <tr> <th>n.□□□X</th> <th colspan="2">Tuning-less Selection</th> <th>When Enabled</th> </tr> </thead> <tbody> <tr> <td>0</td> <td colspan="2">Disable tuning-less function.</td> <td rowspan="2">After restart</td> </tr> <tr> <td>1</td> <td colspan="2">Enable tuning-less function.</td> </tr> </tbody> </table>							n.□□□X	Tuning-less Selection		When Enabled	0	Disable tuning-less function.		After restart	1	Enable tuning-less function.	
	n.□□□X	Tuning-less Selection		When Enabled															
	0	Disable tuning-less function.		After restart															
	1	Enable tuning-less function.																	
		n.□□X□	Reserved parameter (Do not change.)																
	n.□X□□	<table border="1"> <thead> <tr> <th colspan="2">Rigidity Level</th> <th>When Enabled</th> </tr> </thead> <tbody> <tr> <td>0 to 7</td> <td colspan="2">Set the rigidity level.</td> <td>Immediately</td> </tr> </tbody> </table>							Rigidity Level		When Enabled	0 to 7	Set the rigidity level.		Immediately				
Rigidity Level		When Enabled																	
0 to 7	Set the rigidity level.		Immediately																
	n.X□□□	<table border="1"> <thead> <tr> <th colspan="2">Tuning-less Load Level</th> <th>When Enabled</th> </tr> </thead> <tbody> <tr> <td>0 to 2</td> <td colspan="2">Set the load level for the tuning-less function.</td> <td>Immediately</td> </tr> </tbody> </table>							Tuning-less Load Level		When Enabled	0 to 2	Set the load level for the tuning-less function.		Immediately				
Tuning-less Load Level		When Enabled																	
0 to 2	Set the load level for the tuning-less function.		Immediately																
Pn181	2	Mode Switching Level for Speed Reference	0 to 10,000	1 mm/s	0	Linear	Immediately	Tuning	page 8-85										
Pn182	2	Mode Switching Level for Acceleration	0 to 30,000	1 mm/s ²	0	Linear	Immediately	Tuning	page 8-85										
Pn205	2	Multiturn Limit	0 to 65,535	1 rev	65535*2	Rotary	After restart	Setup	page 6-25										
Pn207	2	Reserved parameter (Do not change.)	–	–	0010h*1	All	–	–	–										
Pn20A	4	Number of External Encoder Scale Pitches	4 to 1,048,576	1 scale pitch/revolution	32768	Rotary	After restart	Setup	page 10-6										
Pn20E	4	Electronic Gear Ratio (Numerator)	1 to 1,073,741,824	1	64	All	After restart	Setup	page 5-42										
Pn210	4	Electronic Gear Ratio (Denominator)	1 to 1,073,741,824	1	1	All	After restart	Setup	page 5-42										
Pn212	4	Number of Encoder Output Pulses	16 to 1,073,741,824	1 P/Rev	2048	Rotary	After restart	Setup	page 6-20										
Pn217	2	Average Movement Time of Position Reference	0 to 10,000	0.1 ms	0	All	After the change and also after the motor has stopped	Setup	–										

Continued on next page.

16.2 List of Parameters

16.2.2 List of Parameters

Continued from previous page.

Parameter No.	Size	Name	Setting Range	Setting Unit	Default Setting	Applicable Motors	When Enabled	Classification	Reference
Pn22A	2	Fully-closed Control Selections	0000h to 1003h	–	0000h	Rotary	After restart	Setup	page 10-10
	n.□□□X		Reserved parameter (Do not change.)						
	n.□□X□		Reserved parameter (Do not change.)						
	n.□X□□		Reserved parameter (Do not change.)						
	n.X□□□		Fully-closed Control Speed Feedback Selection						
		0	Use motor encoder speed.						
		1	Use external encoder speed.						
Pn230	2	Reserved parameter (Do not change.)	–	–	0000h	All	–	–	–
Pn231	4	Reserved parameter (Do not change.)	–	–	0	All	–	–	–
Pn233	2	Reserved parameter (Do not change.)	–	–	0	All	–	–	–
Pn281	2	Encoder Output Resolution	1 to 4,096	1 edge/pitch	20	All	After restart	Setup	page 6-21
Pn282	4	Linear Encoder Scale Pitch	0 to 6,553,600	0.01 μm	0	Linear	After restart	Setup	page 5-16
Pn304	2	Jog Operation Speed	0 to 10,000	Rotary: 1 min ⁻¹ Direct Drive: 0.1 min ⁻¹	500	Rotary	Immediately	Setup	page 7-6
Pn305	2	Soft Start Acceleration Time	0 to 10,000	1 ms	0	All	Immediately	Setup	page 7-6
Pn306	2	Soft Start Deceleration Time	0 to 10,000	1 ms	0	All	Immediately	Setup	page 7-6
Pn308	2	Speed Feedback Filter Time Constant	0 to 65,535	0.01 ms	0	All	Immediately	Setup	page 8-79
Pn30A	2	Deceleration Time for Servo OFF and Forced Stops	0 to 10,000	1 ms	0	All	Immediately	Setup	page 5-38
Pn30C	2	Reserved parameter (Do not change.)	–	–	0	All	–	–	–
Pn310	2	Vibration Detection Selections	0000h to 0002h	–	0000h	All	Immediately	Setup	page 6-32
	n.□□□X		Vibration Detection Selection						
		0	Do not detect vibration.						
		1	Output a warning (A.911) if vibration is detected.						
		2	Output an alarm (A.520) if vibration is detected.						
n.□□X□		Reserved parameter (Do not change.)							
n.□X□□		Reserved parameter (Do not change.)							
n.X□□□		Reserved parameter (Do not change.)							
Pn311	2	Vibration Detection Sensitivity	50 to 500	1%	100	All	Immediately	Tuning	page 6-32
Pn312	2	Vibration Detection Level	0 to 5,000	1 min ⁻¹	50	Rotary	Immediately	Tuning	page 6-32
Pn316	2	Maximum Motor Speed	0 to 65,535	1 min ⁻¹	10000	Rotary	After restart	Setup	page 6-14

Continued on next page.

Continued from previous page.

Parameter No.	Size	Name	Setting Range	Setting Unit	Default Setting	Applicable Motors	When Enabled	Classification	Reference	
Pn324	2	Moment of Inertia Calculation Starting Level	0 to 20,000	1%	300	All	Immediately	Setup	page 8-30	
Pn383	2	Jog Operation Speed	0 to 10,000	1 mm/s	50	Linear	Immediately	Setup	page 7-6	
Pn384	2	Vibration Detection Level	0 to 5,000	1 mm/s	10	Linear	Immediately	Tuning	page 6-32	
Pn385	2	Maximum Motor Speed	1 to 100	100 mm/s	50	Linear	After restart	Setup	page 6-14	
Pn401	2	First Stage First Torque Reference Filter Time Constant	0 to 65,535	0.01 ms	100	All	Immediately	Tuning	page 8-76	
Pn402	2	Forward Torque Limit	0 to 800	1%*3	800	Rotary	Immediately	Setup	page 6-22	
Pn403	2	Reverse Torque Limit	0 to 800	1%*3	800	Rotary	Immediately	Setup	page 6-22	
Pn404	2	Reserved parameter (Do not change.)	–	–	100	All	–	–	–	
Pn405	2	Reserved parameter (Do not change.)	–	–	100	All	–	–	–	
Pn406	2	Emergency Stop Torque	0 to 800	1%*3	800	All	Immediately	Setup	page 5-37	
Pn407	2	Reserved parameter (Do not change.)	–	–	10000	Rotary	–	–	–	
Pn408	2	Torque-Related Function Selections	0000h to 1111h	–	0000h	All	–	Setup	–	
	n.□□□X		Notch Filter Selection 1				When Enabled	Reference		
			0	Disable first stage notch filter.			Immediately	page 8-76		
			1	Enable first stage notch filter.						
	n.□□X□		Reserved parameter (Do not change.)							
	n.□X□□		Notch Filter Selection 2				When Enabled	Reference		
			0	Disable second stage notch filter.			Immediately	page 8-76		
		1	Enable second stage notch filter.							
n.X□□□		Friction Compensation Function Selection				When Enabled	Reference			
		0	Disable friction compensation.			Immediately	page 8-67			
		1	Enable friction compensation.							
Pn409	2	First Stage Notch Filter Frequency	50 to 5,000	1 Hz	5000	All	Immediately	Tuning	page 8-76	
Pn40A	2	First Stage Notch Filter Q Value	50 to 1,000	0.01	70	All	Immediately	Tuning	page 8-76	
Pn40B	2	First Stage Notch Filter Depth	0 to 1,000	0.001	0	All	Immediately	Tuning	page 8-76	
Pn40C	2	Second Stage Notch Filter Frequency	50 to 5,000	1 Hz	5000	All	Immediately	Tuning	page 8-76	
Pn40D	2	Second Stage Notch Filter Q Value	50 to 1,000	0.01	70	All	Immediately	Tuning	page 8-76	
Pn40E	2	Second Stage Notch Filter Depth	0 to 1,000	0.001	0	All	Immediately	Tuning	page 8-76	
Pn40F	2	Second Stage Second Torque Reference Filter Frequency	100 to 5,000	1 Hz	5000	All	Immediately	Tuning	page 8-76	
Pn410	2	Second Stage Second Torque Reference Filter Q Value	50 to 100	0.01	50	All	Immediately	Tuning	page 8-76	

Continued on next page.

Continued from previous page.

Parameter No.	Size	Name	Setting Range	Setting Unit	Default Setting	Applicable Motors	When Enabled	Classification	Reference	
Pn412	2	First Stage Second Torque Reference Filter Time Constant	0 to 65,535	0.01 ms	100	All	Immediately	Tuning	page 8-64	
Pn416	2	Torque-Related Function Selections 2	0000h to 1111h	–	0000h	All	Immediately	Setup	page 8-78	
	n.□□□X		Notch Filter Selection 3							
			0	Disable third stage notch filter.						
			1	Enable third stage notch filter.						
	n.□□X□		Notch Filter Selection 4							
			0	Disable fourth stage notch filter.						
			1	Enable fourth stage notch filter.						
	n.□X□□		Notch Filter Selection 5							
			0	Disable fifth stage notch filter.						
			1	Enable fifth stage notch filter.						
n.X□□□		Reserved parameter (Do not change.)								
Pn417	2	Third Stage Notch Filter Frequency	50 to 5,000	1 Hz	5000	All	Immediately	Tuning	page 8-78	
Pn418	2	Third Stage Notch Filter Q Value	50 to 1,000	0.01	70	All	Immediately	Tuning	page 8-78	
Pn419	2	Third Stage Notch Filter Depth	0 to 1,000	0.001	0	All	Immediately	Tuning	page 8-78	
Pn41A	2	Fourth Stage Notch Filter Frequency	50 to 5,000	1 Hz	5000	All	Immediately	Tuning	page 8-78	
Pn41B	2	Fourth Stage Notch Filter Q Value	50 to 1,000	0.01	70	All	Immediately	Tuning	page 8-78	
Pn41C	2	Fourth Stage Notch Filter Depth	0 to 1,000	0.001	0	All	Immediately	Tuning	page 8-78	
Pn41D	2	Fifth Stage Notch Filter Frequency	50 to 5,000	1 Hz	5000	All	Immediately	Tuning	page 8-78	
Pn41E	2	Fifth Stage Notch Filter Q Value	50 to 1,000	0.01	70	All	Immediately	Tuning	page 8-78	
Pn41F	2	Fifth Stage Notch Filter Depth	0 to 1,000	0.001	0	All	Immediately	Tuning	page 8-77	
Pn423	2	Speed Ripple Compensation Selections	0000h to 1111h	–	0000h	Rotary	–	Setup	page 8-62	
	n.□□□X		Speed Ripple Compensation Function Selection						When Enabled	
			0	Disable speed ripple compensation.						Immediately
			1	Enable speed ripple compensation.						
	n.□□X□		Speed Ripple Compensation Information Disagreement Warning Detection Selection						When Enabled	
			0	Detect A.942 alarms.						After restart
			1	Do not detect A.942 alarms.						
	n.□X□□		Speed Ripple Compensation Enable Condition Selection						When Enabled	
			0	Speed reference						After restart
			1	Motor speed						
n.X□□□		Reserved parameter (Do not change.)								

Continued on next page.

Continued from previous page.

Parameter No.	Size	Name	Setting Range	Setting Unit	Default Setting	Applicable Motors	When Enabled	Classification	Reference		
Pn424	2	Torque Limit at Main Circuit Voltage Drop	0 to 100	1%*3	50	All	Immediately	Setup	page 6-13		
Pn425	2	Release Time for Torque Limit at Main Circuit Voltage Drop	0 to 1,000	1 ms	100	All	Immediately	Setup	page 6-13		
Pn426	2	Reserved parameter (Do not change.)	–	–	0	All	–	–	–		
Pn427	2	Speed Ripple Compensation Enable Speed	0 to 10,000	1 min ⁻¹	0	Rotary	Immediately	Tuning	page 8-62		
Pn456	2	Sweep Torque Reference Amplitude	1 to 800	1%	15	All	Immediately	Tuning	page 8-93		
Pn460	2	Notch Filter Adjustment Selections 1		0000h to 0101h	–	0101h	All	Immediately	Tuning	page 8-14, page 8-31	
		n.□□□X	Notch Filter Adjustment Selection 1								
			0	Do not adjust the first stage notch filter automatically during execution of autotuning without a host reference, autotuning with a host reference, and custom tuning.							
			1	Adjust the first stage notch filter automatically during execution of autotuning without a host reference, autotuning with a host reference, and custom tuning.							
		n.□□X□	Reserved parameter (Do not change.)								
		n.□X□□	Notch Filter Adjustment Selection 2								
			0	Do not adjust the second stage notch filter automatically when the tuning-less function is enabled or during execution of autotuning without a host reference, autotuning with a host reference, and custom tuning.							
	1	Adjust the second stage notch filter automatically when the tuning-less function is enabled or during execution of autotuning without a host reference, autotuning with a host reference, and custom tuning.									
n.X□□□	Reserved parameter (Do not change.)										
Pn475	2	Gravity Compensation-Related Selections		0000h to 0001h	–	0000h	All	After restart	Setup	page 8-69	
		n.□□□X	Gravity Compensation Selection								
			0	Disable gravity compensation.							
			1	Enable gravity compensation.							
		n.□□X□	Reserved parameter (Do not change.)								
		n.□X□□	Reserved parameter (Do not change.)								
n.X□□□	Reserved parameter (Do not change.)										
Pn476	2	Gravity Compensation Torque	-1,000 to 1,000	0.1%	0	All	Immediately	Tuning	page 8-69		
Pn480	2	Reserved parameter (Do not change.)	–	–	10000	Linear	–	–	–		
Pn481	2	Polarity Detection Speed Loop Gain	10 to 20,000	0.1 Hz	400	Linear	Immediately	Tuning	–		
Pn482	2	Polarity Detection Speed Loop Integral Time Constant	15 to 51,200	0.01 ms	3000	Linear	Immediately	Tuning	–		
Pn483	2	Forward Force Limit	0 to 800	1%*3	30	Linear	Immediately	Setup	page 6-22		
Pn484	2	Reverse Force Limit	0 to 800	1%*3	30	Linear	Immediately	Setup	page 6-22		
Pn485	2	Polarity Detection Reference Speed	0 to 100	1 mm/s	20	Linear	Immediately	Tuning	–		

Continued on next page.

16.2 List of Parameters

16.2.2 List of Parameters

Continued from previous page.

Parameter No.	Size	Name	Setting Range	Setting Unit	Default Setting	Applicable Motors	When Enabled	Classification	Reference
Pn486	2	Polarity Detection Reference Acceleration/Deceleration Time	0 to 100	1 ms	25	Linear	Immediately	Tuning	–
Pn487	2	Polarity Detection Constant Speed Time	0 to 300	1 ms	0	Linear	Immediately	Tuning	–
Pn488	2	Polarity Detection Reference Waiting Time	50 to 500	1 ms	100	Linear	Immediately	Tuning	–
Pn48E	2	Polarity Detection Range	1 to 65,535	1 mm	10	Linear	Immediately	Tuning	–
Pn490	2	Polarity Detection Load Level	0 to 20,000	1%	100	Linear	Immediately	Tuning	–
Pn495	2	Polarity Detection Confirmation Force Reference	0 to 200	1%	100	Linear	Immediately	Tuning	–
Pn498	2	Polarity Detection Allowable Error Range	0 to 30	1 deg	10	Linear	Immediately	Tuning	–
Pn49F	2	Speed Ripple Compensation Enable Speed	0 to 10,000	1 mm/s	0	Linear	Immediately	Tuning	page 8-62
Pn502	2	Rotation Detection Level	0 to 10,000	1 min ⁻¹	20	Rotary	Immediately	Setup	page 1-10
Pn503	2	Reserved parameter (Do not change.)	–	–	10	Rotary	–	–	–
Pn506	2	Brake Reference-Servo OFF Delay Time	0 to 50	10 ms	0	All	Immediately	Setup	page 5-31
Pn507	2	Brake Reference Output Speed Level	0 to 10,000	1 min ⁻¹	100	Rotary	Immediately	Setup	page 5-31
Pn508	2	Servo OFF-Brake Command Waiting Time	10 to 100	10 ms	50	All	Immediately	Setup	page 5-31
Pn509	2	Momentary Power Interruption Hold Time	20 to 50,000	1 ms	20	All	Immediately	Setup	page 6-11
Pn50A	2	Reserved parameter (Do not change.)	–	–	1881h*1	All	–	–	–
Pn50B	2	Reserved parameter (Do not change.)	–	–	8882h*1	All	–	–	–
Pn50E	2	Reserved parameter (Do not change.)	–	–	0000h*4	All	–	–	–
Pn50F	2	Reserved parameter (Do not change.)	–	–	0100h*5	All	–	–	–
Pn510	2	Reserved parameter (Do not change.)	–	–	0000h*1	All	–	–	–
Pn511	2	Reserved parameter (Do not change.)	–	–	6543h*6	All	–	–	–
Pn512	2	Reserved parameter (Do not change.)	–	–	0000h*7	All	–	–	–
Pn514	2	Reserved parameter (Do not change.)	–	–	0000h	All	–	–	–
Pn516	2	Reserved parameter (Do not change.)	–	–	8888h	All	–	–	–
Pn517	2	Reserved parameter (Do not change.)	–	–	0000h*8	All	–	–	–
Pn518	–	Safety Module-Related Parameters	–	–	–	All	–	–	–
Pn51B	4	Motor-Load Position Deviation Overflow Detection Level	0 to 1,073,741,824	1 reference unit	1000	Rotary	Immediately	Setup	page 10-9
Pn51E	2	Position Deviation Overflow Warning Level	10 to 100	1%	100	All	Immediately	Setup	page 8-8
Pn520	4	Position Deviation Overflow Alarm Level	1 to 1,073,741,823	1 reference unit	5242880	All	Immediately	Setup	page 8-7, page 8-83
Pn522	4	Reserved parameter (Do not change.)	–	–	7*9	All	–	–	–
Pn524	4	Reserved parameter (Do not change.)	–	–	1073741824	All	–	–	–

Continued on next page.

Continued from previous page.

Parameter No.	Size	Name	Setting Range	Setting Unit	Default Setting	Applicable Motors	When Enabled	Classification	Reference														
Pn526	4	Position Deviation Overflow Alarm Level at Servo ON	1 to 1,073,741,823	1 reference unit	5242880	All	Immediately	Setup	page 8-9														
Pn528	2	Position Deviation Overflow Warning Level at Servo ON	10 to 100	1%	100	All	Immediately	Setup	page 8-9														
Pn529	2	Speed Limit Level at Servo ON	0 to 10,000	1 min ⁻¹	10000	Rotary	Immediately	Setup	page 8-9														
Pn52A	2	Multiplier per Fully-closed Rotation	0 to 100	1%	20	Rotary	Immediately	Tuning	page 10-9														
Pn52B	2	Overload Warning Level	1 to 100	1%	20	All	Immediately	Setup	page 5-39														
Pn52C	2	Base Current Derating at Motor Overload Detection	10 to 100	1%	100	All	After restart	Setup	page 5-40														
Pn530	2	Program Jog Operation-Related Selections	0000h to 0005h	–	0000h	All	Immediately	Setup	page 7-13														
			<table border="1"> <thead> <tr> <th colspan="2">Program Jog Operation Pattern</th> </tr> </thead> <tbody> <tr> <td>0</td> <td>(Waiting time in Pn535 → Forward by travel distance in Pn531) × Number of movements in Pn536</td> </tr> <tr> <td>1</td> <td>(Waiting time in Pn535 → Reverse by travel distance in Pn531) × Number of movements in Pn536</td> </tr> <tr> <td>2</td> <td>(Waiting time in Pn535 → Forward by travel distance in Pn531) × Number of movements in Pn536 (Waiting time in Pn535 → Reverse by travel distance in Pn531) × Number of movements in Pn536</td> </tr> <tr> <td>3</td> <td>(Waiting time in Pn535 → Reverse by travel distance in Pn531) × Number of movements in Pn536 (Waiting time in Pn535 → Forward by travel distance in Pn531) × Number of movements in Pn536</td> </tr> <tr> <td>4</td> <td>(Waiting time in Pn535 → Forward by travel distance in Pn531 → Waiting time in Pn535 → Reverse by travel distance in Pn531) × Number of movements in Pn536</td> </tr> <tr> <td>5</td> <td>(Waiting time in Pn535 → Reverse by travel distance in Pn531 → Waiting time in Pn535 → Forward by travel distance in Pn531) × Number of movements in Pn536</td> </tr> </tbody> </table>							Program Jog Operation Pattern		0	(Waiting time in Pn535 → Forward by travel distance in Pn531) × Number of movements in Pn536	1	(Waiting time in Pn535 → Reverse by travel distance in Pn531) × Number of movements in Pn536	2	(Waiting time in Pn535 → Forward by travel distance in Pn531) × Number of movements in Pn536 (Waiting time in Pn535 → Reverse by travel distance in Pn531) × Number of movements in Pn536	3	(Waiting time in Pn535 → Reverse by travel distance in Pn531) × Number of movements in Pn536 (Waiting time in Pn535 → Forward by travel distance in Pn531) × Number of movements in Pn536	4	(Waiting time in Pn535 → Forward by travel distance in Pn531 → Waiting time in Pn535 → Reverse by travel distance in Pn531) × Number of movements in Pn536	5	(Waiting time in Pn535 → Reverse by travel distance in Pn531 → Waiting time in Pn535 → Forward by travel distance in Pn531) × Number of movements in Pn536
	Program Jog Operation Pattern																						
	0	(Waiting time in Pn535 → Forward by travel distance in Pn531) × Number of movements in Pn536																					
	1	(Waiting time in Pn535 → Reverse by travel distance in Pn531) × Number of movements in Pn536																					
	2	(Waiting time in Pn535 → Forward by travel distance in Pn531) × Number of movements in Pn536 (Waiting time in Pn535 → Reverse by travel distance in Pn531) × Number of movements in Pn536																					
	3	(Waiting time in Pn535 → Reverse by travel distance in Pn531) × Number of movements in Pn536 (Waiting time in Pn535 → Forward by travel distance in Pn531) × Number of movements in Pn536																					
	4	(Waiting time in Pn535 → Forward by travel distance in Pn531 → Waiting time in Pn535 → Reverse by travel distance in Pn531) × Number of movements in Pn536																					
	5	(Waiting time in Pn535 → Reverse by travel distance in Pn531 → Waiting time in Pn535 → Forward by travel distance in Pn531) × Number of movements in Pn536																					
		n.□□□□	Reserved parameter (Do not change.)																				
	n.□X□□	Reserved parameter (Do not change.)																					
	n.X□□□	Reserved parameter (Do not change.)																					
Pn531	4	Program Jog Operation Travel Distance	1 to 1,073,741,824	1 reference unit	32768	All	Immediately	Setup	page 7-13														
Pn533	2	Program Jog Operation Movement Jog Operation	1 to 10,000	Rotary: 1 min ⁻¹ Direct Drive: 0.1 min ⁻¹	500	Rotary	Immediately	Setup	page 7-13														
Pn534	2	Program Jog Operation Acceleration/Deceleration Time	2 to 10,000	1 ms	100	All	Immediately	Setup	page 7-13														
Pn535	2	Program Jog Operation Waiting Time	0 to 10,000	1 ms	100	All	Immediately	Setup	page 7-13														
Pn536	2	Program Jog Operation Number of Movements	0 to 1,000	Times	1	All	Immediately	Setup	page 7-13														
Pn550	2	Analog Monitor 1 Offset Voltage	-10,000 to 10,000	0.1 V	0	All	Immediately	Setup	page 9-11														
Pn551	2	Analog Monitor 2 Offset Voltage	-10,000 to 10,000	0.1 V	0	All	Immediately	Setup	page 9-11														

Continued on next page.

16.2 List of Parameters

16.2.2 List of Parameters

Continued from previous page.

Parameter No.	Size	Name	Setting Range	Setting Unit	Default Setting	Applicable Motors	When Enabled	Classification	Reference
Pn552	2	Analog Monitor 1 Magnification	-10,000 to 10,000	× 0.01	100	All	Immediately	Setup	page 9-11
Pn553	2	Analog Monitor 2 Magnification	-10,000 to 10,000	× 0.01	100	All	Immediately	Setup	page 9-11
Pn55A	2	Power Consumption Monitor Unit Time	1 to 1,440	1 min	1	All	Immediately	Setup	—
Pn560	2	Residual Vibration Detection Width	1 to 3,000	0.1%	400	All	Immediately	Setup	page 8-54
Pn561	2	Overshoot Detection Level	0 to 100	1%	100	All	Immediately	Setup	page 8-30, page 8-39
Pn581	2	Zero Speed Level	1 to 10,000	1 mm/s	20	Linear	Immediately	Setup	page 1-10
Pn582	2	Reserved parameter (Do not change.)	—	—	10	Linear	—	—	—
Pn583	2	Brake Reference Output Speed Level	0 to 10,000	1 mm/s	10	Linear	Immediately	Setup	page 5-31
Pn584	2	Speed Limit Level at Servo ON	0 to 10,000	1 mm/s	10000	Linear	Immediately	Setup	page 8-9
Pn585	2	Program Jog Operation Movement Speed	1 to 10,000	1 mm/s	50	Linear	Immediately	Setup	page 7-13
Pn586	2	Motor Running Cooling Ratio	0 to 100	1%/Max. speed	0	Linear	Immediately	Setup	—
Pn587	2	Reserved parameters (Do not change.)	—	—	0000h	Linear	—	—	—
Pn600	2	Regenerative Resistor Capacity*10	Depends on model.*11	10 W	0	All	Immediately	Setup	page 5-54
Pn601	2	Dynamic Brake Resistor Allowable Energy Consumption	0 to 65,535	10 J	0	All	After restart	Setup	*12
Pn603	2	Regenerative Resistance	0 to 65,535	10 mΩ	0	All	Immediately	Setup	page 5-54
Pn604	2	Dynamic Brake Resistance	0 to 65,535	10 mΩ	0	All	After restart	Setup	*12
Pn61A	2	Overheat Protection Selections	0000h to 0003h	—	0000h	All	After restart	Setup	page 6-42
		n.□□□X	Overheat Protection Selection						
		0	Disable overheat protection.						
		1	Use overheat protection in the Yaskawa Linear Servomotor.*13						
		2	Monitor a negative voltage input from a sensor attached to the machine and use overheat protection.						
		3	Monitor a positive voltage input from a sensor attached to the machine and use overheat protection.						
n.□□□□	Reserved parameter (Do not change.)								
n.□□□□	Reserved parameter (Do not change.)								
n.X□□□	Reserved parameter (Do not change.)								
Pn61B*14	2	Overheat Alarm Level	0 to 500	0.01 V	250	All	Immediately	Setup	page 6-42
Pn61C*14	2	Overheat Warning Level	0 to 100	1%	100	All	Immediately	Setup	page 6-42
Pn61D*14	2	Overheat Alarm Filter Time	0 to 65,535	1 s	0	All	Immediately	Setup	page 6-42

Continued on next page.

Continued from previous page.

Parameter No.	Size	Name	Setting Range	Setting Unit	Default Setting	Applicable Motors	When Enabled	Classification	Reference	
PnB00	2	Serial Communication Protocol	0 to 9	–	1	All	After restart	Setup	page 14-6	
		0	Full-duplex wiring is used for communications method.							
		1	Full-duplex wiring is used for communications method. Echoback is performed for each character.							
		2	Half-duplex wiring is used for communications method. CR is used as delimiter.							
		3	Half-duplex wiring is used for communications method. CR is used as delimiter. Echoback is performed for each character.							
		4	Half-duplex wiring is used for communications method. CR is used as delimiter. Echoback is performed for each command.							
		5	Half-duplex wiring is used for communications method. CRLF is used as delimiter.							
		6	Half-duplex wiring is used for communications method. CRLF is used as delimiter. Echoback is performed for each character.							
		7	Half-duplex wiring is used for communications method. CRLF is used as delimiter. Echoback is performed for each command.							
8, 9	Reserved parameter									
PnB01	2	Bit rate	0 to 2	–	0	All	After restart	Setup	page 14-6	
		0	Sets bit rate at 9600 bps.							
		1	Sets bit rate at 19200 bps.							
		2	Sets bit rate at 38400 bps.							
PnB02	2	Response "OK"	0 or 1	–	1	All	Immediately	Setup	page 14-6	
		0	Does not return OK answer.							
		1	Returns OK answer.							
PnB03	2	/MODE 0/1	0 to 3	–	0	All	After restart	Setup	page 6-4	
		0	When input signal is ON (closed), mode is set to Mode 0.							
		1	When input signal is OFF (open), mode is set to Mode 0.							
		2	Always Mode 0.							
		3	Always Mode 1.							
PnB04	2	/START-STOP; /HOME	0 to 3	–	0	All	After restart	Setup	page 6-4	
		0	<ul style="list-style-type: none"> When /MODE signal is ON (closed) (mode 0): Starts program table operation when the /START-STOP signal turns ON (closes). Stops program table operation when the /START-STOP signal turns OFF (opens). When /MODE signal is OFF (open) (mode 1): Starts homing when the /HOME signal turns ON (closes). 							
		1	<ul style="list-style-type: none"> When /MODE signal is ON (closed) (mode 0): Starts program table operation when the /START-STOP signal turns OFF (opens). Stops program table operation when the /START-STOP signal turns ON (closes). When /MODE signal is OFF (open) (mode 1): Starts homing when the /HOME signal turns OFF (opens). 							
		2, 3	<ul style="list-style-type: none"> When /MODE signal is ON (closed) (mode 0): The /START-STOP signal is not used. When /MODE signal is OFF (open) (mode 1): The /HOME signal is not used. 							

Continued on next page.

16.2 List of Parameters

16.2.2 List of Parameters

Continued from previous page.

Parameter No.	Size	Name	Setting Range	Setting Unit	Default Setting	Applicable Motors	When Enabled	Classification	Reference
PnB05	2	/PGMRES; /JOGP	0 to 3	–	0	All	After restart	Setup	page 6-5
	0	<ul style="list-style-type: none"> When /MODE signal is ON (closed) (mode 0): Resets and cancels program table operation by switching the /PGMRES signal from OFF (open) to ON (closed). When /MODE signal is OFF (open) (mode 1): Executes JOG operation in the forward direction while the /JOGP signal is ON (closed). 							
	1	<ul style="list-style-type: none"> When /MODE signal is ON (closed) (mode 0): Resets and cancels program table operation by switching the /PGMRES signal from ON (closed) to OFF (open). When /MODE signal is OFF (open) (mode 1): Executes JOG operation in the forward direction while the /JOGP signal is OFF (open). 							
	2, 3	<ul style="list-style-type: none"> When /MODE signal is ON (closed) (mode 0): Program table operation is not reset. When /MODE signal is OFF (open) (mode 1): Does not execute JOG operation. 							
PnB06	2	/SEL0; /JOGN	0 to 3	–	0	All	After restart	Setup	page 6-6
	0	<ul style="list-style-type: none"> When /MODE signal is ON (closed) (mode 0): The /SEL0 signal is active when ON (closed). When /MODE signal is OFF (open) (mode 1): Executes JOG operation in the reverse direction while the /JOGN signal is ON (closed). 							
	1	<ul style="list-style-type: none"> When /MODE signal is ON (closed) (mode 0): The /SEL0 signal is active when OFF (open). When /MODE signal is OFF (open) (mode 1): Executes JOG operation in the reverse direction while the /JOGN signal is OFF (open). 							
	2	<ul style="list-style-type: none"> When /MODE signal is ON (closed) (mode 0): The /SEL0 signal is always active. When /MODE signal is OFF (open) (mode 1): Does not execute JOG operation. 							
	3	<ul style="list-style-type: none"> When /MODE signal is ON (closed) (mode 0): The /SEL0 signal is always inactive. When /MODE signal is OFF (open) (mode 1): Does not execute JOG operation. 							
PnB07	2	/SEL1; /JOG0	0 to 3	–	0	All	After restart	Setup	page 6-6
	0	<ul style="list-style-type: none"> When /MODE signal is ON (closed) (mode 0): The /SEL1 signal is active when ON (closed). When /MODE signal is OFF (open) (mode 1): The /JOG0 signal is active when ON (closed). 							
	1	<ul style="list-style-type: none"> When /MODE signal is ON (closed) (mode 0): The /SEL1 signal is active when OFF (open). When /MODE signal is OFF (open) (mode 1): The /JOG0 signal is active when OFF (open). 							
	2	<ul style="list-style-type: none"> When /MODE signal is ON (closed) (mode 0): The /SEL1 signal is always active. When /MODE signal is OFF (open) (mode 1): The /JOG0 signal is always active. 							
	3	<ul style="list-style-type: none"> When /MODE signal is ON (closed) (mode 0): The /SEL1 signal is always inactive. When /MODE signal is OFF (open) (mode 1): The /JOG0 signal is always inactive. 							
PnB08	2	/SEL2; /JOG1	0 to 3	–	0	All	After restart	Setup	page 6-6
	0	<ul style="list-style-type: none"> When /MODE signal is ON (closed) (mode 0): The /SEL2 signal is active when ON (closed). When /MODE signal is OFF (open) (mode 1): The /JOG1 signal is active when ON (closed). 							
	1	<ul style="list-style-type: none"> When /MODE signal is ON (closed) (mode 0): The /SEL2 signal is active when OFF (open). When /MODE signal is OFF (open) (mode 1): The /JOG1 signal is active when OFF (open). 							
	2	<ul style="list-style-type: none"> When /MODE signal is ON (closed) (mode 0): The /SEL2 signal is always active. When /MODE signal is OFF (open) (mode 1): The /JOG1 signal is always active. 							
	3	<ul style="list-style-type: none"> When /MODE signal is ON (closed) (mode 0): The /SEL2 signal is always inactive. When /MODE signal is OFF (open) (mode 1): The /JOG1 signal is always inactive. 							

Continued on next page.

Continued from previous page.

Parameter No.	Size	Name	Setting Range	Setting Unit	Default Setting	Applicable Motors	When Enabled	Classification	Reference
PnB09	2	/SEL3; /JOG2	0 to 3	–	0	All	After restart	Setup	page 6-6
	0	<ul style="list-style-type: none"> When /MODE signal is ON (closed) (mode 0): The /SEL3 signal is active when ON (closed). When /MODE signal is OFF (open) (mode 1): The /JOG2 signal is active when ON (closed). 							
	1	<ul style="list-style-type: none"> When /MODE signal is ON (closed) (mode 0): The /SEL3 signal is active when OFF (open). When /MODE signal is OFF (open) (mode 1): The /JOG2 signal is active when OFF (open). 							
	2	<ul style="list-style-type: none"> When /MODE signal is ON (closed) (mode 0): The /SEL3 signal is always active. When /MODE signal is OFF (open) (mode 1): The /JOG2 signal is always active. 							
	3	<ul style="list-style-type: none"> When /MODE signal is ON (closed) (mode 0): The /SEL3 signal is always inactive. When /MODE signal is OFF (open) (mode 1): The /JOG2 signal is always inactive. 							
PnB0A	2	/SEL4; /JOG3	0 to 3	–	0	All	After restart	Setup	page 6-6
	0	<ul style="list-style-type: none"> When /MODE signal is ON (closed) (mode 0): The /SEL4 signal is active when ON (closed). When /MODE signal is OFF (open) (mode 1): The /JOG3 signal is active when ON (closed). 							
	1	<ul style="list-style-type: none"> When /MODE signal is ON (closed) (mode 0): The /SEL4 signal is active when OFF (open). When /MODE signal is OFF (open) (mode 1): The /JOG3 signal is active when OFF (open). 							
	2	<ul style="list-style-type: none"> When /MODE signal is ON (closed) (mode 0): The /SEL4 signal is always active. When /MODE signal is OFF (open) (mode 1): The /JOG3 signal is always active. 							
	3	<ul style="list-style-type: none"> When /MODE signal is ON (closed) (mode 0): The /SEL4 signal is always inactive. When /MODE signal is OFF (open) (mode 1): The /JOG3 signal is always inactive. 							
PnB0B	2	/SEL5	0 to 3	–	0	All	After restart	Setup	page 6-7
	0	The /SEL5 signal is active when ON (closed).							
	1	The /SEL5 signal is active when OFF (open).							
	2	The /SEL5 signal is always active.							
	3	The /SEL5 signal is always inactive.							
PnB0C	2	/SEL6	0 to 3	–	0	All	After restart	Setup	page 6-7
	0	The /SEL6 signal is active when ON (closed).							
	1	The /SEL6 signal is active when OFF (open).							
	2	The /SEL6 signal is always active.							
	3	The /SEL6 signal is always inactive.							
PnB0D	2	/SEL7	0 to 3	–	0	All	After restart	Setup	page 6-7
	0	The /SEL7 signal is active when ON (closed).							
	1	The /SEL7 signal is active when OFF (open).							
	2	The /SEL7 signal is always active.							
	3	The /SEL7 signal is always inactive.							
PnB0E	2	/S-ON	0 to 3	–	0	All	After restart	Setup	page 6-3
	0	The system changes to the SERVO ON state (power is supplied) and operation is enabled when the /S-ON signal turns ON (closes).							
	1	The system changes to the SERVO ON state (power is supplied) and operation is enabled when the /S-ON signal turns OFF (opens).							
	2	Always servo ON							
	3	Always servo OFF							

Continued on next page.

16.2 List of Parameters

16.2.2 List of Parameters

Continued from previous page.

Parameter No.	Size	Name	Setting Range	Setting Unit	Default Setting	Applicable Motors	When Enabled	Classification	Reference
PnB0F	2	P-OT	0 to 3	–	0	All	After restart	Setup	page 5-28
	0	Forward drive is prohibited (forward overtravel) when P-OT is OFF (open).							
	1	Forward drive is prohibited (forward overtravel) when P-OT is ON (closed).							
	2	Forward run is always prohibited (forward overtravel).							
	3	Forward run is always enabled. (P-OT signal is not used.)							
PnB10	2	N-OT	0 to 3	–	0	All	After restart	Setup	page 5-28
	0	Reverse drive is prohibited (reverse overtravel) when N-OT is OFF (open).							
	1	Reverse drive is prohibited (reverse overtravel) when N-OT is ON (closed).							
	2	Reverse run is always prohibited (reverse overtravel).							
	3	Reverse run is always enabled. (N-OT signal is not used.)							
PnB11	2	/DEC	0 to 3	–	0	All	After restart	Setup	page 6-3
	0	Starts deceleration during homing when the /DEC signal turns ON (closes).							
	1	Starts deceleration during homing when the /DEC signal turns OFF (opens).							
	2	Sets the homing limit switch always ON.							
	3	Sets the homing limit switch always OFF.							
PnB12	2	/RGRT	0 to 3	–	0	All	After restart	Setup	page 6-4
	0	Starts registration by switching the /RGRT signal from OFF (open) to ON (closed).							
	1	Starts registration by switching the /RGRT signal from ON (closed) to OFF (open).							
	2, 3	Does not start registration.							
PnB13	2	/INPOSITION	0 to 3	–	0	All	After restart	Setup	page 6-9
	0	When positioning has been completed, the /INPOSITION signal turns ON (closes).							
	1	When positioning has been completed, the /INPOSITION signal turns OFF (opens).							
	2, 3	Reserved settings							
PnB14	2	/POUT0	0 or 1	–	0	All	After restart	Setup	page 6-10
	0	The /POUT0 signal turns ON (opens) when programmable output 0 is active.							
	1	The /POUT0 signal turns OFF (closes) when programmable output 0 is active.							
PnB15	2	/POUT1	0 or 1	–	0	All	After restart	Setup	page 6-10
	0	The /POUT1 signal turns ON (opens) when programmable output 1 is active.							
	1	The /POUT1 signal turns OFF (closes) when programmable output 1 is active.							
PnB16	2	/POUT2	0 or 1	–	0	All	After restart	Setup	page 6-10
	0	The /POUT2 signal turns ON (opens) when programmable output 2 is active.							
	1	The /POUT2 signal turns OFF (closes) when programmable output 2 is active.							
PnB17	2	/POUT3	0 or 1	–	0	All	After restart	Setup	page 6-10
	0	The /POUT3 signal turns ON (opens) when programmable output 3 is active.							
	1	The /POUT3 signal turns OFF (closes) when programmable output 3 is active.							

Continued on next page.

Continued from previous page.

Parameter No.	Size	Name	Setting Range	Setting Unit	Default Setting	Applicable Motors	When Enabled	Classification	Reference	
PnB18	2	/POUT4	0 or 1	–	0	All	After restart	Setup	page 6-10	
		0	The /POUT4 signal turns ON (opens) when programmable output 4 is active.							
		1	The /POUT4 signal turns OFF (closes) when programmable output 4 is active.							
PnB19	2	/POUT5	0 or 1	–	0	All	After restart	Setup	page 6-10	
		0	The /POUT5 signal turns ON (opens) when programmable output 5 is active.							
		1	The /POUT5 signal turns OFF (closes) when programmable output 5 is active.							
PnB1A	2	/POUT6	0 or 1	–	0	All	After restart	Setup	page 6-10	
		0	The /POUT6 signal turns ON (opens) when programmable output 6 is active.							
		1	The /POUT6 signal turns OFF (closes) when programmable output 6 is active.							
PnB1B	2	/POUT7	0 or 1	–	0	All	After restart	Setup	page 6-10	
		0	The /POUT7 signal turns ON (opens) when programmable output 7 is active.							
		1	The /POUT7 signal turns OFF (closes) when programmable output 7 is active.							
PnB1C	2	/WARN	0 or 1	–	0	All	After restart	Setup	page 6-8	
		0	When an error/warning occurs (error/warning status), the /WARN signal turns ON (closes).							
		1	When an error/warning occurs (error/warning status), the /WARN signal turns OFF (opens).							
PnB1D	2	/BK	0 or 1	–	0	All	After restart	Setup	page 5-32	
		0	When braking signal /BK is ON (closed), brake is released.							
		1	When braking signal /BK is OFF (open), brake is released.							
PnB1E	2	/S-RDY	0 or 1	–	0	All	After restart	Setup	page 6-8	
		0	When the SERVOPACK is ready, the /S-RDY signal turns ON (closes).							
		1	When the SERVOPACK is ready, the /S-RDY signal turns OFF (opens).							
PnB1F	2	Overtravel (OT) Stop Method	0 to 2	–	0	All	After restart	Setup	page 5-28	
		0	Stops the motor with the same method as when the servo is turned OFF (according to setting of Pn001 = n.□□□X).							
		1	Stops motor immediately, and then changes motor state to servo lock.							
		2	Decelerates motor to a stop at deceleration rate set with PnB2B, and then changes motor state to servo lock.							
PnB20	2	Moving Mode	0 to 3	–	0	All	After restart	Setup	page 12-2	
		0	Sets coordinates to linear type.							
		1	Sets coordinates to rotary type. Moving mode is set as shortest path.							
		2	Sets coordinates to rotary type. Moving mode is always set as forward.							
		3	Sets coordinates to rotary type. Moving mode is always set as reverse.							
PnB21	4	Linear coordinates (PnB20 = 0): Forward Software Limit (P-LS) Rotational coordinates (PnB20 ≠ 0): Last Rotational Coordinate	-99999999 to +99999999*15	1 reference unit	+99999999	All	After restart	Setup	page 12-2	

Continued on next page.

16.2 List of Parameters

16.2.2 List of Parameters

Continued from previous page.

Parameter No.	Size	Name	Setting Range	Setting Unit	Default Setting	Applicable Motors	When Enabled	Classification	Reference		
PnB23	4	Linear coordinates (PnB20 = 0): Reverse Software Limit (N-LS) Rotational coordinates (PnB20 ≠ 0): First Rotational Coordinate	-99999999 to +99999999*15	1 reference unit	-99999999	All	After restart	Setup	page 12-2		
PnB25	4	When using an incremental encoder: Origin When using an absolute encoder: Absolute Encoder Offset	-99999999 to +99999999*15	1 reference unit	0	All	After restart	Setup	page 12-2, page 12-6, page 13-5, page 14-12		
PnB27	4	Positioning/Registration Speed	1 to 99999999*15	1000 Reference units/min	1000	All	After restart	Setup	page 12-4		
PnB29	4	Acceleration rate	1 to 99999999*15	1000 (Reference units/min)/ms	1000	All	Immediately	Setup	page 12-4		
PnB2B	4	Deceleration rate	1 to 99999999*15	1000 (Reference units/min)/ms	1000	All	Immediately	Setup			
PnB2D	4	/INPOSITION Width	1 to 99999	Reference unit	1	All	Immediately	Setup	page 6-9		
PnB2F	4	/NEAR Width	1 to 99999	Reference unit	1	All	Immediately	Setup	page 13-12		
PnB31	2	Homing Method	0 to 3	–	0	All	After restart	Setup	page 13-5, page 14-12		
		0	Homing is not executed.								
		1	/DEC and phase C are used for homing.								
		2	Only /DEC is used for homing.								
PnB32	2	Homing Direction	0 or 1	–	0	All	Immediately	Setup	page 13-5, page 14-12		
		0	/HOME or ZRN command is used for homing in forward direction.								
		1	/HOME or ZRN command is used for homing in reverse direction.								
PnB33	4	Homing Moving Speed	1 to 99999999*15	1000 Reference units/min	1000	All	Immediately	Setup	page 13-5, page 14-12		
PnB35	4	Homing Approach Speed	1 to 99999999*15	1000 Reference units/min	1000	All	Immediately	Setup	page 13-6, page 14-12		
PnB37	4	Homing Creep Speed	1 to 99999999*15	1000 Reference units/min	1000	All	Immediately	Setup	page 13-6, page 14-12		

Continued on next page.

Continued from previous page.

Parameter No.	Size	Name	Setting Range	Setting Unit	Default Setting	Applicable Motors	When Enabled	Classification	Reference	
PnB39	4	Homing Final Move Distance	-99999999 to +99999999*15	1 reference unit	0	All	Immediately	Setup	page 13-6, page 14-12	
PnB3B to PnB4D	4	Reserved parameters (Do not change.)	–	–	0	All	–	Setup	–	
PnB4F	2	ZONE Signal Setting	0000h or 0001h	–	0000h	All	After restart	Setup	page 13-54	
		0000h	When the control power supply is turned ON or the SERVOPACK is reset, the /POUT0 to /POUT7 signals are disabled.							
		0001h	When control power is turned ON or SERVOPACK is reset, the /POUT0 to /POUT7 signals are the ZONE signals.							
PnB50	2	Backlash Compensation	-1000 to +1000	Reference unit	0	All	Immediately	Setup	page 8-71	
PnB51	2	/ALO Output Selection	0, 1	–	0	All	After restart	Setup	page 6-7	
		0	Does not output /ALO1 to /ALO3. (/WARN, /BK, and /S-RDY are output.)							
		1	Outputs /ALO1 to /ALO3. (/WARN, /BK, and /S-RDY are not output.)							
PnB52	2	/ALM-RST	0 to 3	–	0	All	After restart	Setup	page 15-50	
		0	Resets an alarm by switching the /ALM-RST signal from OFF (open) to ON (closed).							
		1	Resets an alarm by switching the /ALM-RST signal from ON (closed) to OFF (open).							
		2, 3	Does not reset alarms. (Signal is ignored.)							
PnB53	2	Input Signal Monitor IN1 Polarity Selection	0000h to 00FFh	–	0050h	All	After restart	Setup	–	
		Bit 0	Input Signal Monitor IN1 Bit 0 (/SVON) (0: Do not invert the data (default setting), 1: Invert the data.)							
		Bit 1	Input Signal Monitor IN1 Bit 1 (/ALM-RST) (0: Do not invert the data (default setting), 1: Invert the data.)							
		Bit 2	Input Signal Monitor IN1 Bit 2 (/P-OT) (0: Do not invert the data (default setting), 1: Invert the data.)							
		Bit 3	Input Signal Monitor IN1 Bit 3 (/N-OT) (0: Do not invert the data (default setting), 1: Invert the data.)							
		Bit 4	Input Signal Monitor IN1 Bit 4 (/DEC) (0: Do not invert the data, 1: Invert the data (default setting).)							
		Bit 5	Input Signal Monitor IN1 Bit 5 (not used) (0: Do not invert the data (default setting), 1: Invert the data.)							
		Bit 6	Input Signal Monitor IN1 Bit 6 (/RGRT) (0: Do not invert the data, 1: Invert the data (default setting).)							
		Bit 7	Input Signal Monitor IN1 Bit 7 (not used) (0: Do not invert the data (default setting), 1: Invert the data.)							
PnB54	2	Speed/Position Expansion Function Selection	0, 1	–	0	All	After restart	Setup	–	

*1. The following parameters are automatically set when the INDEXER Module is mounted to the SERVOPACK. Do not change the setting.
 • Pn002 = n.□□□0
 • Pn207 = n.1□□□
 • Pn50A = 8881h
 • Pn50B = 8888h
 • Pn510 = 0000h

*2. This parameter is automatically set to 0 if a single-turn absolute encoder is used and Pn002 is set to n.□0□□.

*3. Set a percentage of the motor rated torque.

*4. When the INDEXER Module is mounted to the SERVOPACK, Pn50E is set to 0000h or 3000h according to the setting of PnB51. Do not change the setting.

*5. When the INDEXER Module is mounted to the SERVOPACK, Pn50F is set to 0000h or 1200h according to the setting of PnB51. Do not change the setting.

*6. When the INDEXER Module is mounted to the SERVOPACK, this parameter is automatically set according to the settings of PnB11 and PnB12. (Pn511 = n.8□■8, where □ = 4, 8, or D and ■ = 6, 8, or F) Do not change the setting.

16.2 List of Parameters

16.2.2 List of Parameters

- *7. When the INDEXER Module is mounted to the SERVOPACK, this parameter is automatically set according to the settings of PnB1C, PnB1D, PnB1E, and PnB51. (Pn512 = n.0□□□, where □ = 0 or 1) Do not change the setting.
- *8. When the INDEXER Module is mounted to the SERVOPACK, Pn517 is set to 0000h or 0321h according to the setting of PnB51. Do not change the setting.
- *9. When the INDEXER Module is mounted to the SERVOPACK, this parameter is automatically set to between 0 and 99,999 according to the setting of PnB2D. Do not change the setting.
- *10. Normally set this parameter to 0. If you use an External Regenerative Resistor, set the capacity (W) of the External Regenerative Resistor.
- *11. The upper limit is the maximum output capacity (W) of the SERVOPACK.
- *12. These parameters are for SERVOPACKs with the Dynamic Brake Hardware Option. Refer to the following manual for details.
 Σ -7-Series AC Servo Drive Σ -7S/ Σ -7W SERVOPACK with Dynamic Brake Hardware Option Specifications Product Manual (Manual No.: SIEP S800001 73)
- *13. The SGLFW2 is the only Yaskawa Linear Servomotor that supports this function.
- *14. Enabled only when Pn61A is set to n.□□□2 or n.□□□3.
- *15. If you set PnB54 to 1 (Enable Expansion Mode), the following setting ranges will change.

Parameter No.	Name	Setting Range
PnB21	<ul style="list-style-type: none"> • Linear coordinates (PnB20 = 0): Forward Software Limit (P-LS) • Rotational coordinates (PnB20 ≠ 0): Last Rotational Coordinate 	-536,870,911 to +536,870,911
PnB23	<ul style="list-style-type: none"> • Linear coordinates (PnB20 = 0): Reverse Software Limit (N-LS) • Rotational coordinates (PnB20 ≠ 0): First Rotational Coordinate 	-536,870,911 to +536,870,911
PnB25	<ul style="list-style-type: none"> • When using an incremental encoder: Origin • When using an absolute encoder: Absolute Encoder Offset 	-1,073,741,823 to +1,073,741,823
PnB27	Positioning/Registration Speed	1 to 199,999,999
PnB29	Acceleration Rate	1 to 199,999,999
PnB2B	Deceleration Rate	1 to 199,999,999
PnB33	Homing Movement Speed	1 to 199,999,999
PnB35	Homing Approach Speed	1 to 199,999,999
PnB37	Homing Creep Speed	1 to 199,999,999
PnB39	Homing Final Travel Distance	-1,073,741,823 to +1,073,741,823

16.3 Parameter Recording Table

Use the following table to record the settings of the parameters.

Parameter No.	Default Setting					Name	When Enabled
Pn000	0000h					Basic Function Selections 0	After restart
Pn001	0000h					Application Function Selections 1	After restart
Pn002	0000h* ¹					Application Function Selections 2	After restart
Pn006	0002h					Application Function Selections 6	Immediately
Pn007	0000h					Application Function Selections 7	Immediately
Pn008	4000h					Application Function Selections 8	After restart
Pn009	0010h					Application Function Selections 9	After restart
Pn00A	0001h					Application Function Selections A	After restart
Pn00B	0000h					Application Function Selections B	After restart
Pn00C	0000h					Application Function Selections C	After restart
Pn00D	0000h					Application Function Selections D	Immediately
Pn00E	0000h					Reserved parameter	–
Pn00F	0000h					Application Function Selections F	After restart
Pn010	0001h					Axis Address Selection (For UART/USB communications)	After restart
Pn021	0000					Reserved parameter	–
Pn022	0000h					Reserved parameter	–
Pn040	0000h					Σ-V Compatible Function Switch	After restart
Pn080	0000h					Application Function Selections 80	After restart
Pn081	0000h					Application Function Selections 81	After restart
Pn100	400					Speed Loop Gain	Immediately
Pn101	2000					Speed Loop Integral Time Constant	Immediately
Pn102	400					Position Loop Gain	Immediately
Pn103	100					Moment of Inertia Ratio	Immediately
Pn104	400					Second Speed Loop Gain	Immediately
Pn105	2000					Second Speed Loop Integral Time Constant	Immediately
Pn106	400					Second Position Loop Gain	Immediately
Pn109	0					Feedforward	Immediately
Pn10A	0					Feedforward Filter Time Constant	Immediately
Pn10B	0000h					Gain Application Selections	* ²

Continued on next page.

Continued from previous page.

Parameter No.	Default Setting						Name	When Enabled
Pn10C	200						Mode Switching Level for Torque Reference	Immediately
Pn10D	0						Mode Switching Level for Speed Reference	Immediately
Pn10E	0						Mode Switching Level for Acceleration	Immediately
Pn10F	0						Mode Switching Level for Position Deviation	Immediately
Pn11F	0						Position Integral Time Constant	Immediately
Pn121	100						Friction Compensation Gain	Immediately
Pn122	100						Second Friction Compensation Gain	Immediately
Pn123	0						Friction Compensation Coefficient	Immediately
Pn124	0						Friction Compensation Frequency Correction	Immediately
Pn125	100						Friction Compensation Gain Correction	Immediately
Pn131	0						Gain Switching Time 1	Immediately
Pn132	0						Gain Switching Time 2	Immediately
Pn135	0						Gain Switching Waiting Time 1	Immediately
Pn136	0						Gain Switching Waiting Time 2	Immediately
Pn139	0000h						Automatic Gain Switching Selections 1	Immediately
Pn13D	2000						Current Gain Level	Immediately
Pn140	0100h						Model Following Control-Related Selections	Immediately
Pn141	500						Model Following Control Gain	Immediately
Pn142	1000						Model Following Control Gain Correction	Immediately
Pn143	1000						Model Following Control Bias in the Forward Direction	Immediately
Pn144	1000						Model Following Control Bias in the Reverse Direction	Immediately
Pn145	500						Vibration Suppression 1 Frequency A	Immediately
Pn146	700						Vibration Suppression 1 Frequency B	Immediately
Pn147	1000						Model Following Control Speed Feedforward Compensation	Immediately
Pn148	500						Second Model Following Control Gain	Immediately
Pn149	1000						Second Model Following Control Gain Correction	Immediately
Pn14A	800						Vibration Suppression 2 Frequency	Immediately
Pn14B	100						Vibration Suppression 2 Correction	Immediately

Continued on next page.

Continued from previous page.

Parameter No.	Default Setting						Name	When Enabled
Pn14F	0011h						Control-Related Selections	After restart
Pn160	0010h						Anti-Resonance Control-Related Selections	Immediately
Pn161	1000						Anti-Resonance Frequency	Immediately
Pn162	100						Anti-Resonance Gain Correction	Immediately
Pn163	0						Anti-Resonance Damping Gain	Immediately
Pn164	0						Anti-Resonance Filter Time Constant 1 Correction	Immediately
Pn165	0						Anti-Resonance Filter Time Constant 2 Correction	Immediately
Pn166	0						Anti-Resonance Damping Gain 2	Immediately
Pn170	1401h						Tuning-less Function-Related Selections	*2
Pn181	0						Mode Switching Level for Speed Reference	Immediately
Pn182	0						Mode Switching Level for Acceleration	Immediately
Pn205	65535*1						Multiturn Limit	After restart
Pn207	0010h*1						Reserved parameter (Do not change.)	After restart
Pn20A	32768						Number of External Scale Pitches	After restart
Pn20E	64						Electronic Gear Ratio (Numerator)	After restart
Pn210	1						Electronic Gear Ratio (Denominator)	After restart
Pn212	2048						Number of Encoder Output Pulses	After restart
Pn217	0						Average Movement Time of Position Reference	Immediately after the motor stops
Pn22A	0000h						Fully-closed Control Selections	After restart
Pn230	0000h						Reserved parameter (Do not change.)	-
Pn231	0						Reserved parameter (Do not change.)	-
Pn233	0						Reserved parameter (Do not change.)	-
Pn281	20						Encoder Output Resolution	After restart
Pn282	0						Linear Encoder Pitch	After restart
Pn304	500						Jog Operation Speed	Immediately
Pn305	0						Soft Start Acceleration Time	Immediately
Pn306	0						Soft Start Deceleration Time	Immediately
Pn308	0						Speed Feedback Filter Time Constant	Immediately
Pn30A	0						Deceleration Time for Servo OFF and Forced Stops	Immediately

Continued on next page.

Continued from previous page.

Parameter No.	Default Setting						Name	When Enabled
Pn30C	0						Reserved parameter (Do not change.)	-
Pn310	0000h						Vibration Detection Selections	Immediately
Pn311	100						Vibration Detection Sensitivity	Immediately
Pn312	50						Vibration Detection Level	Immediately
Pn316	10000						Maximum Motor Speed	After restart
Pn324	300						Moment of Inertia Calculation Starting Level	Immediately
Pn383	50						Jog Operation Speed	Immediately
Pn384	10						Vibration Detection Level	Immediately
Pn385	50						Maximum Motor Speed	After restart
Pn401	100						First Stage First Torque Reference Filter Time Constant	Immediately
Pn402	800						Forward Torque Limit	Immediately
Pn403	800						Reverse Torque Limit	Immediately
Pn404	100						Reserved parameter (Do not change.)	-
Pn405	100						Reserved parameter (Do not change.)	-
Pn406	800						Emergency Stop Torque	Immediately
Pn407	10000						Reserved parameter (Do not change.)	-
Pn408	0000h						Torque-Related Function Selections	*2
Pn409	5000						First Stage Notch Filter Frequency	Immediately
Pn40A	70						First Stage Notch Filter Q Value	Immediately
Pn40B	0						First Stage Notch Filter Depth	Immediately
Pn40C	5000						Second Stage Notch Filter Frequency	Immediately
Pn40D	70						Second Stage Notch Filter Q Value	Immediately
Pn40E	0						Second Stage Notch Filter Depth	Immediately
Pn40F	5000						Second Stage Second Torque Reference Filter Frequency	Immediately
Pn410	50						Second Stage Second Torque Reference Filter Q Value	Immediately
Pn412	100						First Stage Second Torque Reference Filter Time Constant	Immediately
Pn416	0000h						Torque-Related Function Selections 2	Immediately
Pn417	5000						Third Stage Notch Filter Frequency	Immediately
Pn418	70						Third Stage Notch Filter Q Value	Immediately
Pn419	0						Third Stage Notch Filter Depth	Immediately

Continued on next page.

Continued from previous page.

Parameter No.	Default Setting						Name	When Enabled
Pn41A	5000						Fourth Stage Notch Filter Frequency	Immediately
Pn41B	70						Fourth Stage Notch Filter Q Value	Immediately
Pn41C	0						Fourth Stage Notch Filter Depth	Immediately
Pn41D	5000						Fifth Stage Notch Filter Frequency	Immediately
Pn41E	70						Fifth Stage Notch Filter Q Value	Immediately
Pn41F	0						Fifth Stage Notch Filter Depth	Immediately
Pn423	0000h						Speed Ripple Compensation Selections	*2
Pn424	50						Torque Limit at Main Circuit Voltage Drop	Immediately
Pn425	100						Release Time for Torque Limit at Main Circuit Voltage Drop	Immediately
Pn426	0						Reserved parameter	–
Pn427	0						Speed Ripple Compensation Enable Speed	Immediately
Pn456	15						Sweep Torque Reference Amplitude	Immediately
Pn460	0101h						Notch Filter Adjustment Selections 1	Immediately
Pn475	0000h						Gravity Compensation-Related Selections	After restart
Pn476	0						Gravity Compensation Torque	Immediately
Pn480	10000						Reserved parameter	–
Pn481	400						Polarity Detection Speed Loop Gain	Immediately
Pn482	3000						Polarity Detection Speed Loop Integral Time Constant	Immediately
Pn483	30						Forward Force Limit	Immediately
Pn484	30						Reverse Force Limit	Immediately
Pn485	20						Polarity Detection Reference Speed	Immediately
Pn486	25						Polarity Detection Reference Acceleration/Deceleration Time	Immediately
Pn487	0						Polarity Detection Constant Speed Time	Immediately
Pn488	100						Polarity Detection Reference Waiting Time	Immediately
Pn48E	10						Polarity Detection Range	Immediately
Pn490	100						Polarity Detection Load Level	Immediately
Pn495	100						Polarity Detection Confirmation Force Reference	Immediately
Pn498	10						Polarity Detection Allowable Error Range	Immediately
Pn49F	0						Speed Ripple Compensation Enable Speed	Immediately

Continued on next page.

Continued from previous page.

Parameter No.	Default Setting						Name	When Enabled
Pn502	20						Rotation Detection Level	Immediately
Pn503	10						Reserved parameter	–
Pn506	0						Brake Reference-Servo OFF Delay Time	Immediately
Pn507	100						Brake Reference Output Speed Level	Immediately
Pn508	50						Servo OFF-Brake Command Waiting Time	Immediately
Pn509	20						Momentary Power Interruption Hold Time	Immediately
Pn50A	1881h ^{*1}						Reserved parameter	–
Pn50B	8882h ^{*1}						Reserved parameter	–
Pn50E	0000h ^{*1}						Reserved parameter	–
Pn50F	0100h ^{*1}						Reserved parameter	–
Pn510	0000h ^{*1}						Reserved parameter	–
Pn511	6543h ^{*1}						Reserved parameter	–
Pn512	0000h ^{*1}						Reserved parameter	–
Pn514	0000h						Reserved parameter	–
Pn516	8888h						Reserved parameter	–
Pn517	0000h ^{*1}						Reserved parameter	–
Pn51B	1000						Motor-Load Position Deviation Overflow Detection Level	Immediately
Pn51E	100						Position Deviation Overflow Warning Level	Immediately
Pn520	5242880						Position Deviation Overflow Alarm Level	Immediately
Pn522	7 ^{*1}						Reserved parameter	–
Pn524	1073741824						Reserved parameter	–
Pn526	5242880						Position Deviation Overflow Alarm Level at Servo ON	Immediately
Pn528	100						Position Deviation Overflow Warning Level at Servo ON	Immediately
Pn529	10000						Speed Limit Level at Servo ON	Immediately
Pn52A	20						Multiplier per Fully-closed Rotation	Immediately
Pn52B	20						Overload Warning Level	Immediately
Pn52C	100						Base Current Derating at Motor Overload Detection	After restart
Pn530	0000h						Program Jog Operation-Related Selections	Immediately
Pn531	32768						Program Jog Operation Travel Distance	Immediately
Pn533	500						Program Jog Operation Movement Speed	Immediately
Pn534	100						Program Jog Operation Acceleration/Deceleration Time	Immediately
Pn535	100						Program Jog Operation Waiting Time	Immediately

Continued on next page.

Continued from previous page.

Parameter No.	Default Setting						Name	When Enabled
Pn536	1						Program Jog Operation Number of Movements	Immediately
Pn550	0						Analog Monitor 1 Offset Voltage	Immediately
Pn551	0						Analog Monitor 2 Offset Voltage	Immediately
Pn552	100						Analog Monitor 1 Magnification	Immediately
Pn553	100						Analog Monitor 2 Magnification	Immediately
Pn55A	1						Power Consumption Monitor Unit Time	Immediately
Pn560	400						Residual Vibration Detection Width	Immediately
Pn561	100						Overshoot Detection Level	Immediately
Pn581	20						Zero Speed Level	Immediately
Pn582	10						Reserved parameter	–
Pn583	10						Brake Reference Output Speed Level	Immediately
Pn584	10000						Speed Limit Level at Servo ON	Immediately
Pn585	50						Program Jog Operation Movement Speed	Immediately
Pn586	0						Motor Running Cooling Ratio	Immediately
Pn587	0000h						Reserved parameter	–
Pn600	0						Regenerative Resistor Capacity	Immediately
Pn601	0						Dynamic Brake Resistor Allowable Energy Consumption	After restart
Pn603	0						Regenerative Resistance	Immediately
Pn604	0						Dynamic Brake Resistance	After restart
Pn61A	0000h						Overheat Protection Selections	After restart
Pn61B	250						Overheat Alarm Level	Immediately
Pn61C	100						Overheat Warning Level	Immediately
Pn61D	0						Overheat Alarm Filter Time	Immediately
PnB00	1						Serial Communication Protocol	After restart
PnB01	0						Bit rate	After restart
PnB02	1						Response "OK"	Immediately
PnB03	0						/MODE 0/1	After restart
PnB04	0						/START-STOP; /HOME	After restart
PnB05	0						/PGMRES; /JOGP	After restart
PnB06	0						/SEL0; /JOGN	After restart
PnB07	0						/SEL1; /JOG0	After restart
PnB08	0						/SEL2; /JOG1	After restart
PnB09	0						/SEL3; /JOG2	After restart
PnB0A	0						/SEL4; /JOG3	After restart
PnB0B	0						/SEL5	After restart
PnB0C	0						/SEL6	After restart
PnB0D	0						/SEL7	After restart

Continued on next page.

Continued from previous page.

Parameter No.	Default Setting						Name	When Enabled
PnB0E	0						/S-ON	After restart
PnB0F	0						P-OT	After restart
PnB10	0						N-OT	After restart
PnB11	0						/DEC	After restart
PnB12	0						/RGRT	After restart
PnB13	0						/INPOSITION	After restart
PnB14	0						/POUT0	After restart
PnB15	0						/POUT1	After restart
PnB16	0						/POUT2	After restart
PnB17	0						/POUT3	After restart
PnB18	0						/POUT4	After restart
PnB19	0						/POUT5	After restart
PnB1A	0						/POUT6	After restart
PnB1B	0						/POUT7	After restart
PnB1C	0						/WARN	After restart
PnB1D	0						/BK	After restart
PnB1E	0						/S-RDY	After restart
PnB1F	0						Overtravel (OT) Stop Method	After restart
PnB20	0						Moving Mode	After restart
PnB21	+99999999						<ul style="list-style-type: none"> Linear coordinates (PnB20 = 0): Forward Software Limit (P-LS) Rotational coordinates (PnB20 ≠ 0): Last Rotational Coordinate 	After restart
PnB23	-99999999						<ul style="list-style-type: none"> Linear coordinates (PnB20 = 0): Reverse Software Limit (N-LS) Rotational coordinates (PnB20 ≠ 0): First Rotational Coordinate 	After restart
PnB25	0						<ul style="list-style-type: none"> When using an incremental encoder: Origin When using an absolute encoder: Absolute Encoder Offset 	After restart
PnB27	1000						Positioning/Registration Speed	After restart
PnB29	1000						Acceleration rate	Immediately
PnB2B	1000						Deceleration rate	Immediately
PnB2D	1						/INPOSITION Width	Immediately
PnB2F	1						/NEAR Width	Immediately
PnB31	0						Homing Method	After restart
PnB32	0						Homing Direction	Immediately
PnB33	1000						Homing Moving Speed	Immediately
PnB35	1000						Homing Approach Speed	Immediately
PnB37	1000						Homing Creep Speed	Immediately
PnB39	0						Homing Final Move Distance	Immediately
PnB3B to PnB4D	0						Reserved parameters	–
PnB4F	0000h						ZONE Signal Setting	After restart
PnB50	0						Backlash Compensation	Immediately

Continued on next page.

Continued from previous page.

Parameter No.	Default Setting						Name	When Enabled
PnB51	0						/ALO Output Selection	After restart
PnB52	0						/ALM-RST	After restart
PnB53	0050h						Input Signal Monitor IN1 Polarity Selection	After restart
PnB54	0						Speed/Position Expansion Function Selection	After restart

*1. This parameter is automatically set when the INDEXER Module is mounted to the SERVOPACK. Do not change the setting. Refer to the following sections for details.

 16.2 List of Parameters on page 16-3

*2. The enable timing depends on the digit that is changed. Refer to the following section for details.

 16.2 List of Parameters on page 16-3

Appendices

17

The appendix provides information on compatibility between SERVOPACK functions and SigmaWin+ functions, Digital Operator procedures, an alphabetized list of serial commands, and a table of corresponding parameter numbers.

17.1	Corresponding SERVOPACK and SigmaWin+ Function Names . .	17-2
17.1.1	Corresponding SERVOPACK Utility Function Names	17-2
17.1.2	Corresponding SERVOPACK Monitor Display Function Names	17-4
17.2	Operation of Digital Operator	17-8
17.2.1	Overview	17-8
17.2.2	Operation of Utility Functions	17-10
17.3	Alphabetical List of Serial Commands	17-31
17.4	Corresponding Parameter Numbers	17-34

17.1 Corresponding SERVOPACK and SigmaWin+ Function Names

This section gives the names and numbers of the utility functions and monitor display functions used by the SERVOPACKs and the names used by the SigmaWin+.

17.1.1 Corresponding SERVOPACK Utility Function Names

SigmaWin+		SERVOPACK			
Button in Menu Dialog Box	Function Name	Fn No.	Function Name	Serial Command	
Basic Functions	Initialize	FnB0B	Initialize INDEXER Parameter Settings	PRMINIT	
	Software Reset	Fn030	Software Reset	-	
	Setup Wizard	-	-	-	
	I/O Signal Allocation	-	-	-	
	Product Information		Fn011	Display Servomotor Model	MTTYPE, MTSIZE, PGTYPE, SVYSPEC
			Fn012	Display Software Version	SVVER, PGVER, VER
			Fn01E	Display SERVOPACK and Servomotor IDs	TYPE
Fn01F			Display Servomotor ID from Feedback Option Module	-	
Encoder Setting	Reset Absolute Encoder	Fn008	Reset Absolute Encoder	ABSPGRES	
	Multi-turn Limit Setup	Fn013	Multiturn Limit Setting after Multiturn Limit Disagreement Alarm	MLTLIMSET	
	Search Origin	Fn003	Origin Search	-	
	Zero Point Position Setting	Fn020	Set Absolute Linear Encoder Origin	-	
	Polarity Detection	Fn080	Polarity Detection	-	
	Motor Parameter Scale Write	-	-	-	
	-	FnB09	Set Absolute Encoder Origin	ZSET	
Table Editing	Edit Program Table	FnB03	Edit/Save Program Table	PGMSTORE	
		FnB06	Initialize Program Table	PGMINIT	
	Edit ZONE Table	FnB04	Edit/Save ZONE Table	ZONESTORE	
		FnB07	Initialize ZONE Table	ZONEINIT	
	Edit Jog Speed Table	FnB05	Edit/Save Jog Speed Table	JSPDSTORE	
		FnB08	Initialize Jog Speed Table	JSPDINIT	
Trouble-shooting	Display Alarm	FnB0D	Display INDEXER Alarm History	ALMn	
		FnB0C	Reset INDEXER Alarm History	ALMTRCCLR	
			Reset INDEXER Alarm	ARES	
	Fn014	Reset Option Module Configuration Error	-		
	Alarm Trace	-	-	-	
Reset Motor Type Alarm	Fn021	Reset Motor Type Alarm	-		
Operation	Jog	Fn002	Jog	-	
	Program JOG Operation	Fn004	Jog Program	-	

Continued on next page.

Continued from previous page.

SigmaWin+		SERVOPACK		
Button in Menu Dialog Box	Function Name	Fn No.	Function Name	Serial Command
Monitor	Trace	-	-	-
	Real Time Trace	-	-	-
	Monitor	FnB0A	INDEXER Status Monitor	ALM, ERR, IN2, OUT2, STS, PUN, PFB, POS, DST, RPOS, RDST, PGMSTEP, EVTIME, LOOP
	Life Monitor	-	-	-
Tuning	Tuning - Autotuning without Host Reference	Fn201	Advanced Autotuning without Reference	
	Tuning - Autotuning with Host Reference	Fn202	Advanced Autotuning with Reference	
	Tuning - Custom Tuning	Fn203	One-Parameter Tuning	-
	Tuning - Custom Tuning - Adjust Anti-resonance Control	Fn204	Adjust Anti-resonance Control	
	Tuning - Custom Tuning - Vibration Suppression	Fn205	Vibration Suppression	
	System Tuning	-	-	-
	Response Level Setting	Fn200	Tuning-less Level Setting	-
	Edit Online Parameters	-	-	-
Diagnostic	Mechanical Analysis	-	-	-
	Easy FFT	Fn206	Easy FFT	-
	Ripple Compensation	-	-	-
	Online Vibration Monitor	-	-	-
Others	Adjust the Analog Monitor Output	Fn00C	Adjust Analog Monitor Output Offset	-
		Fn00D	Adjust Analog Monitor Output Gain	-
	Adjust the Motor Current Detection Offsets	Fn00E	Autotune Motor Current Detection Signal Offset	CURZERO
		Fn00F	Manually Adjust Motor Current Detection Signal Offset	-
	Initialize Vibration Detection Level	Fn01B	Initialize Vibration Detection Level	-
	Parameter Converter	-	-	-
	SERVOPACK Axis Name Setting	-	-	-
	Write Prohibited Setting	Fn010	Write Prohibition Setting	-
Motor Parameter SERVOPACK Write	-	-	-	

17.1.2 Corresponding SERVOPACK Monitor Display Function Names

SigmaWin+		SERVOPACK		
Button in Menu Dialog Box	Name [Unit]	Un No.	Name [Unit]	Serial Command
Motion Monitor	Motor Speed [min^{-1}]	Un000	Motor Speed [min^{-1}]	NFB
	Speed Reference [min^{-1}]	Un001	Speed Reference [min^{-1}]	-
	Torque Reference [%]	Un002	Torque Reference [%] (percentage of rated torque)	TREF
	<ul style="list-style-type: none"> Rotary Servomotors: Rotational Angle 1 [encoder pulses] (number of encoder pulses from encoder phase C) Linear Servomotors: Electrical Angle 1 [linear encoder pulses] (linear encoder pulses from the polarity origin) 	Un003	<ul style="list-style-type: none"> Rotary Servomotors: Rotational Angle 1 [encoder pulses] (number of encoder pulses from encoder phase C displayed in decimal) Linear Servomotors: Electrical Angle 1 [linear encoder pulses] (linear encoder pulses from the polarity origin displayed in decimal) 	-
	<ul style="list-style-type: none"> Rotary Servomotors: Rotational Angle 2 [deg] (electrical angle from polarity origin) Linear Servomotors: Electrical Angle 2 [deg] (electrical angle from polarity origin) 	Un004	<ul style="list-style-type: none"> Rotary Servomotors: Rotational Angle 2 [deg] (electrical angle from polarity origin) Linear Servomotors: Electrical Angle 2 [deg] (electrical angle from polarity origin) 	-
	Input Reference Pulse Speed [min^{-1}]	Un007	Input Reference Pulse Speed [min^{-1}] (displayed only during position control)	NREF
	Position Deviation [reference units]	Un008	Position Error Amount [reference units] (displayed only during position control)	PER
	Accumulated Load Ratio [%]	Un009	Accumulated Load Ratio [%] (percentage of rated torque: effective torque in cycles of 10 seconds)	TRMS
	Regenerative Load Ratio [%]	Un00A	Regenerative Load Ratio [%] (percentage of processable regenerative power: regenerative power consumption in cycles of 10 seconds)	RGRMS
Dynamic Brake Resistor Power Consumption [%]	Un00B	Power Consumed by DB Resistance [%] (percentage of processable power at DB activation: displayed in cycles of 10 seconds)	DBRMS	

Continued on next page.

Continued from previous page.

SigmaWin+		SERVOPACK		
Button in Menu Dialog Box	Name [Unit]	Un No.	Name [Unit]	Serial Command
Motion Monitor	Input Reference Pulse Counter [reference units]	Un00C	Input Reference Pulse Counter [reference units]	-
	Feedback Pulse Counter [encoder pulses]	Un00D	Feedback Pulse Counter [encoder pulses]	
	Fully-closed Loop Feedback Pulse Counter [external encoder resolution]	Un00E	Fully-closed Loop Feedback Pulse Counter [external encoder resolution]	
	Upper Limit Setting of Motor Maximum Speed/Upper Limit Setting of Encoder Output Resolution	Un010*1	Upper Limit Setting of Motor Maximum Speed/Upper Limit Setting of Encoder Output Resolution	
	Total Operation Time [100 ms]	Un012	Total Operation Time [100 ms]	
	Feedback Pulse Counter [reference units]	Un013	Feedback Pulse Counter [reference units]	
	Overheat Protection Input [0.01 V]	Un02F	Overheat Protection Input [0.01 V]	
	Current Backlash Compensation Value [0.1 reference units]	Un030	Current Backlash Compensation Value [0.1 reference units]	
	Backlash Compensation Value Setting Limit [0.1 reference units]	Un031	Backlash Compensation Value Setting Limit [0.1 reference units]	
	Power Consumption [W]	Un032	Power Consumption [W]	
	Consumed Power [0.001 Wh]	Un033	Consumed Power [0.001 Wh]	
	Cumulative Power Consumption [Wh]	Un034	Cumulative Power Consumption [Wh]	
	Absolute Encoder Multiturn Data	Un040	Absolute Encoder Multiturn Data	
	Position within One Rotation of Absolute Encoder [encoder pulses]	Un041	Position within One Rotation of Absolute Encoder [encoder pulses]	
	Lower Bits of Absolute Encoder Position [encoder pulses]	Un042	Lower Bits of Absolute Encoder Position [encoder pulses]	
Upper Bits of Absolute Encoder Position [encoder pulses]	Un043	Upper Bits of Absolute Encoder Position [encoder pulses]		

Continued on next page.

17.1 Corresponding SERVOPACK and SigmaWin+ Function Names

17.1.2 Corresponding SERVOPACK Monitor Display Function Names

Continued from previous page.

SigmaWin+		SERVOPACK		
Button in Menu Dialog Box	Name [Unit]	Un No.	Name [Unit]	Serial Command
Motion Monitor	Error Monitor	FnB0A	INDEXER Status Monitor	ALM, ERR, IN2, OUT2, STS, PUN, PFB, POS, DST, RPOS, RDST, PGM-STEP, EVTIME, and LOOP
	Current issue position			
	Current motor position			
	Target position			
	Target distance			
	Registration target position			
	Registration target distance			
	Program step			
	Program event lapse time			
	Program loop pass through time			
	Number of serial command receipt letter			
	Number of serial command transmission error letter			
Number of serial command transmission letter				
Status Monitor	Polarity Sensor Signal Monitor	Un011	Polarity Sensor Signal Monitor	HALLSENS
	Active Gain Monitor	Un014	Effective Gain Monitor (gain settings 1 = 1, gain settings 2 = 2)	-
	Safety I/O Signal Monitor	Un015	Safety I/O Signal Monitor	
Input Signal Monitor	Input Signal Monitor	Un005	Input Signal Monitor	IN1
Output Signal Monitor	Output Signal Monitor	Un006	Output Signal Monitor	OUT1

Continued from previous page.

SigmaWin+		SERVOPACK		
Button in Menu Dialog Box	Name [Unit]	Un No.	Name [Unit]	Serial Command
Service Life Monitor	Installation Environment Monitor – SERVOPACK	Un025	SERVOPACK Installation Environment Monitor [%]	–
	Installation Environment Monitor – Servomotor*2	Un026	Servomotor Installation Environment Monitor [%]	
	Service Life Prediction Monitor – Built-in Fan	Un027	Built-in Fan Remaining Life Ratio [%]	
	Service Life Prediction Monitor – Capacitor	Un028	Capacitor Remaining Life Ratio [%]	
	Service Life Prediction Monitor – Surge Prevention Circuit	Un029	Surge Prevention Circuit Remaining Life Ratio [%]	
	Service Life Prediction Monitor – Dynamic Brake Circuit	Un02A	Dynamic Brake Circuit Remaining Life Ratio [%]	
Product Information	Motor – Resolution	Un084	Linear Encoder Pitch (Scale pitch = $Un084 \times 10^{Un085}$ [µm])	–
		Un085	Linear Encoder Pitch Exponent (Scale pitch = $Un084 \times 10^{Un085}$ [µm])	
–	–	Un020	Rated Motor Speed [min^{-1}]	–
	–	Un021	Maximum Motor Speed [min^{-1}]	

*1. You can use Un010 to monitor the upper limit setting for the maximum motor speed or the upper limit setting for the encoder output resolution.

You can monitor the upper limit of the encoder output resolution setting (Pn281) for the current maximum motor speed setting (Pn385), or you can monitor the upper limit of the maximum motor speed setting for the current encoder output resolution setting.

Select which signal to monitor with Pn080 = n.X□□□ (Calculation Method for Maximum Speed or Divided Output Pulses).

- If Pn080 = n.0□□□, the encoder output resolution (Pn281) that can be set is displayed.
- If Pn080 = n.1□□□, the maximum motor speed (Pn385) that can be set is displayed in mm/s.

*2. This applies to the following motors. The display will show 0 for all other models.

SGM7M, SGM7J, SGM7A, SGM7P, SGM7G, SGMMV, SGM7E, SGM7F, and SGMCV

17.2 Operation of Digital Operator

17.2.1 Overview

Functions List

The table below shows whether functions of the digital operator can or cannot be used when an INDEXER Module is installed.

This chapter describes the operating procedures for the functions indicated with the thick-bordered frame in the table below. Refer to the following manual for information on functions that are not marked with bold lines.

📖 Σ -7-Series Servo Drive Digital Operator Operating Manual (Manual No.: SIEP S800001 33)

	Parameters/Monitoring Functions			Utility Functions		Parameter Copy Functions	
	SERVOPACK Parameters	SERVOPACK Monitor Display	INDEXER Module Parameters	SERVOPACK Utility Functions	INDEXER Module Utility Functions	SERVOPACK Parameters	INDEXER Module Parameters
	Pn000 to Pn95F	Un000 to Un085	PnB00 to PnB52	Fn000 to Fn207	FnB03 to FnB0D	Pn000 to Pn95F	PnB00 to PnB52
When an INDEXER Module is installed	✓	✓	✓	✓*1	✓*1	✓	—*2
When no INDEXER Module is installed	✓	✓	—	✓	—	✓	—

✓: Supported

—: Not supported

*1. Refer to the following section for details.

📖 17.2.2 Operation of Utility Functions on page 17-10

*2. To copy the INDEXER Module parameters (PnB00 to PnB52), use the SigmaWin+ parameter editing function.

Changing the Function

Connect the digital operator to the SERVOPACK, and turn ON the power to the SERVOPACK. The initial display appears, and then the Parameter/Monitoring Function screen appears. Press the  key to change the function.

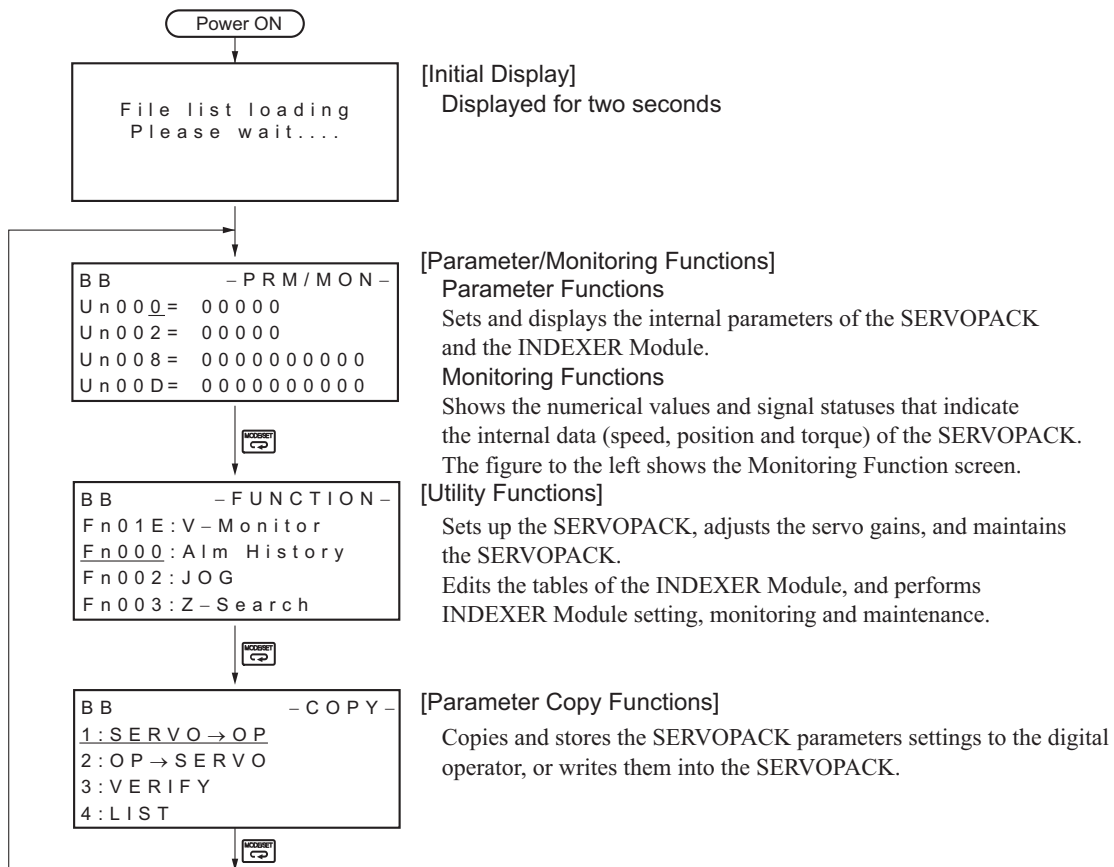

Reading the Screen

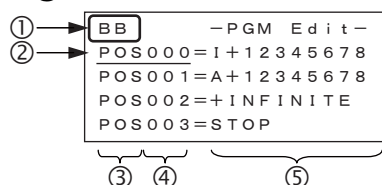

- The SERVOPACK status is always displayed at the top left of the screen (①).
BB: Base blocked
RUN: Servomotor is ON
A.□□□ : Alarm/warning is in effect (□□□ is the alarm/warning code).
PT NT: Forward run and reverse run prohibited (Over travel)
P-OT: Forward run prohibited (Over travel)
N-OT: Reverse run prohibited (Over travel)
P-LS: Forward software limit
N-LS: Reverse software limit
NO-OP: Setting disabled or setting error
HBB: During hard wire base block
- The figure of editing screen used in the program tables, ZONE tables and JOG speed tables has the following elements.
 - ②: The article and table number currently selected
 - ③: The article of the table
 - ④: The table number
 - ⑤: The table settings

Note: The line beneath POS000 shows that this indication is flashing. This line does not appear on the actual screen. Note also that the part that flashes is referred to as the cursor in this document.

17.2.2 Operation of Utility Functions

Utility Functions

The following table shows whether utility functions can be set or not with the digital operator.

Fn No.	Function	Possible/Not Possible	Remarks and Reference
Fn000	Alarm history display	×	This utility function cannot be used. Execute FnB0D instead.
Fn002	JOG operation	○	Σ-7-Series Servo Drive Digital Operator Operating Manual (Manual No.: S1EP S800001 33)
Fn003	Origin search	○	
Fn004	Program JOG operation	○	
Fn005	Initializing parameter settings	×	
Fn006	Clearing alarm history	×	This utility function cannot be used. Execute FnB0C instead.
Fn008	Absolute encoder multiturn reset and encoder alarm reset	○	Σ-7-Series Servo Drive Digital Operator Operating Manual (Manual No.: S1EP S800001 33)
Fn00C	Offset adjustment of analog monitor output	○	
Fn00D	Gain adjustment of analog monitor output	○	
Fn00E	Automatic offset-signal adjustment of motor current detection signal	○	
Fn00F	Manual offset-signal adjustment of motor current detection signal	○	
Fn010	Write prohibited setting	○	
Fn011	Servomotor model display	○	
Fn012	SERVOPACK software version display	○	
Fn013	Multiturn limit value setting change when a multiturn limit disagreement alarm (A.CC0) occurs	○	
Fn014	Resetting configuration error in option module	○	
Fn01B	Vibration detection level initialization	○	
Fn01E	Display of SERVOPACK and servomotor ID	○	
Fn01F	Display of servomotor ID in feedback option module	○	
Fn020	Origin setting	○	
Fn030	Software reset	○	
Fn080	Polarity detection	○	
Fn200	Tuning-less levels setting	○	
Fn201	Advanced autotuning	○	
Fn202	Advanced autotuning by reference	○	
Fn203	One-parameter tuning	○	
Fn204	Anti-resonance control adjustment function	○	
Fn205	Vibration suppression function	○	
Fn206	EasyFFT	○	
Fn207	Online vibration monitor	○	
FnB03	Program table edit/save	○	<i>Program Table Edit/Save (FnB03) on page 17-11</i>
FnB04	ZONE table edit/save	○	<i>ZONE Table Edit/Save (FnB04) on page 17-17</i>

○: Possible ×: Not possible

Continued on next page.

Continued from previous page.

Fn No.	Function	Possible/Not Possible	Remarks and Reference
FnB05	JOG speed table edit/save	○	<i>JOG Speed Table Edit/Save (FnB05)</i> on page 17-19
FnB06	Program table initialization	○	<i>Program Table Initialization (FnB06)</i> on page 17-21
FnB07	ZONE table initialization	○	<i>ZONE Table Initialization (FnB07)</i> on page 17-22
FnB08	JOG speed table initialization	○	<i>JOG Speed Table Initialization (FnB08)</i> on page 17-23
FnB09	Absolute encoder origin setting	○	<i>Absolute Encoder Origin Setting (FnB09)</i> on page 17-24
FnB0A	INDEXER status monitor	○	<i>INDEXER Status Monitor (FnB0A)</i> on page 17-25
FnB0B	INDEXER parameter setting initialization	○	<i>INDEXER Parameter Setting Initialization (FnB0B)</i> on page 17-28
FnB0C	INDEXER alarm reset	○	<i>INDEXER Alarm Reset (FnB0C)</i> on page 17-29
FnB0D	INDEXER alarm history display	○	<i>INDEXER Alarm History Display (FnB0D)</i> on page 17-30

○: Possible ×: Not possible

Program Table Edit/Save (FnB03)

This function edits and saves program tables. Saving a program table to flash memory after editing it ensures that the data will be retained even after the control power has been turned off.

■ Codes Displayed on the Program Table Editing Screen

Refer to the following section for information on interpreting the displays.

 *Reading the Screen* on page 17-9

PGM STEP	POS	SPD	RDST	RSPD	ACC	DEC	POUT	EVENT	LOOP	NEXT
0	POS000	SPD000	RDST000	RSPD000	ACC000	DEC000	POUT000	EVT000	LOOP000	NEXT000
1	POS001	SPD001	RDST001	RSPD001	ACC001	DEC001	POUT001	EVT001	LOOP001	NEXT001
⋮	⋮	⋮	⋮	⋮	⋮	⋮	⋮	⋮	⋮	⋮
255	POS255	SPD255	RDST255	RSPD255	ACC255	DEC255	POUT255	EVT255	LOOP255	NEXT255







































◆ Preparation

The following conditions must be met to edit and save program tables.

- The write-prohibited setting (Fn010) must not be set to write-protect parameters.
- The program must not be running or on hold.
- A program table save operation must not be in progress for any means other than the digital operator.
- Execution of the RES command must not be in progress.

◆ Editing Program Table

The operating procedure when setting the acceleration (ACC) in program step 5 is explained here.

Step	Display after Operation	Keys	Operation
1	<pre>BB -FUNCTION- Fn207 V-Monitor FnB03 PGM Edit FnB04 ZONE Edit FnB05 JSPD Edit</pre>	  	Press the  key to open the Utility Function Mode main menu, and move the cursor with the   keys to select FnB03.
2	<pre>BB -PGM Edit- POS000=STOP POS001=STOP POS002=STOP POS003=STOP</pre>		Press the  key to view the FnB03 operation screen.
3	<pre>BB -PGM Edit- ACC002=: ACC003=: ACC004=: ACC005=:</pre>	     +   + 	Move the cursor using the   keys and   keys (or the  +  and  +  keys) to select the article and program step of the program table to be edited. Refer to the following section for details on the methods to move the cursor.  ■ <i>Method for Moving the Cursor</i> on page 17-13
4	<pre>BB -PGM Edit- ACC002=: ACC003=: ACC004=: ACC005=.</pre>		Press the  key to move the cursor to the setting side of the table.
5	<pre>BB -PGM Edit- ACC002=: ACC003=: ACC004=: ACC005=0000<u>1</u>000</pre>	   	Move the cursor with the   keys, and change the table settings with the   keys.* Refer to the following section for detailed setting methods for each item.  ◆ <i>Details on How to Set Table Settings</i> on page 17-14
6	<pre>BB -PGM Edit- ACC002=: ACC003=: ACC004=: ACC005=00001000</pre>		On pressing the  key, the setting is entered and the cursor returns to the program table article and program step side.
7	Repeat steps 3 to 6 to set the program table. On completing the setting of all the program tables to be used, save the program tables to flash memory by following the procedure in ◆ Saving Program Tables on page 17-16.		

* If setting is attempted in an operation prohibited state, it will not be possible to change the setting. In this case, make the setting again by referring to **◆ Preparation** on page 17-11.

■ Method for Moving the Cursor

The values within the frames in the figure below are the articles and steps of the program table displayed at the digital operator.

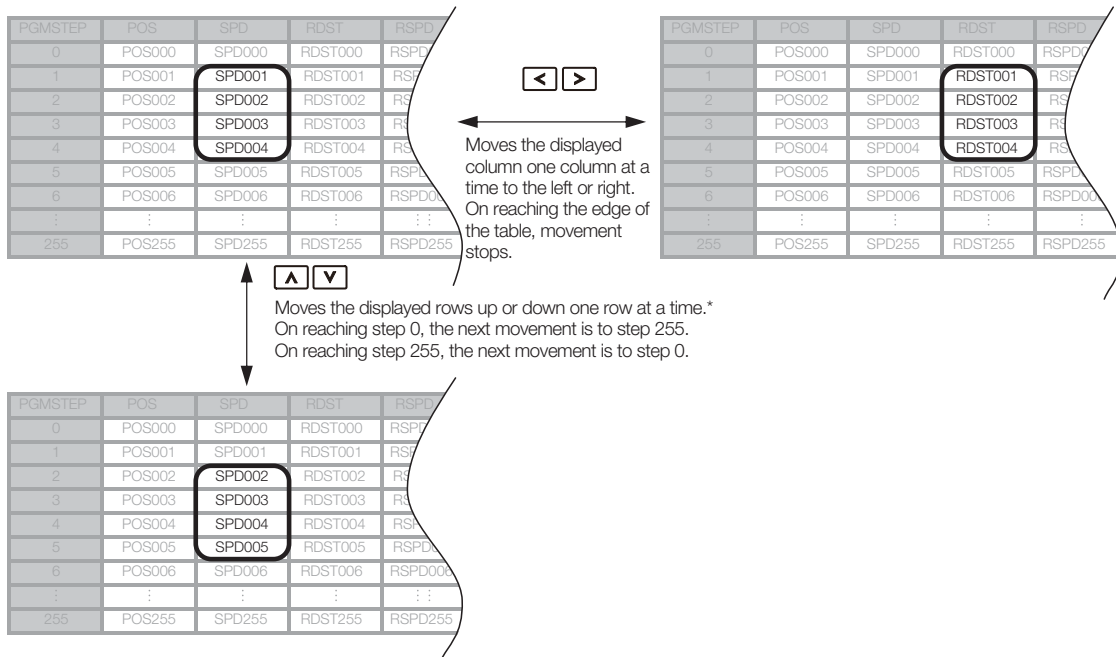

* You can move 4 rows at a time by holding down the <u>^</u> or <u>v</u> key. By using the SCROLL key at the same time as these keys, you can move 30 rows at a time.

◆ Details on How to Set Table Settings

Details on the setting method for step 5 in *Editing Program Table* on page 17-12 are shown below.

If the number of display digits is exceeded when Expansion Mode is enabled (PnB54 = 1), the table name will be abbreviated. Refer to the following section for details.

☞ 12.4.6 *Digital Operator Displays* on page 12-12

■ POS: Target Position

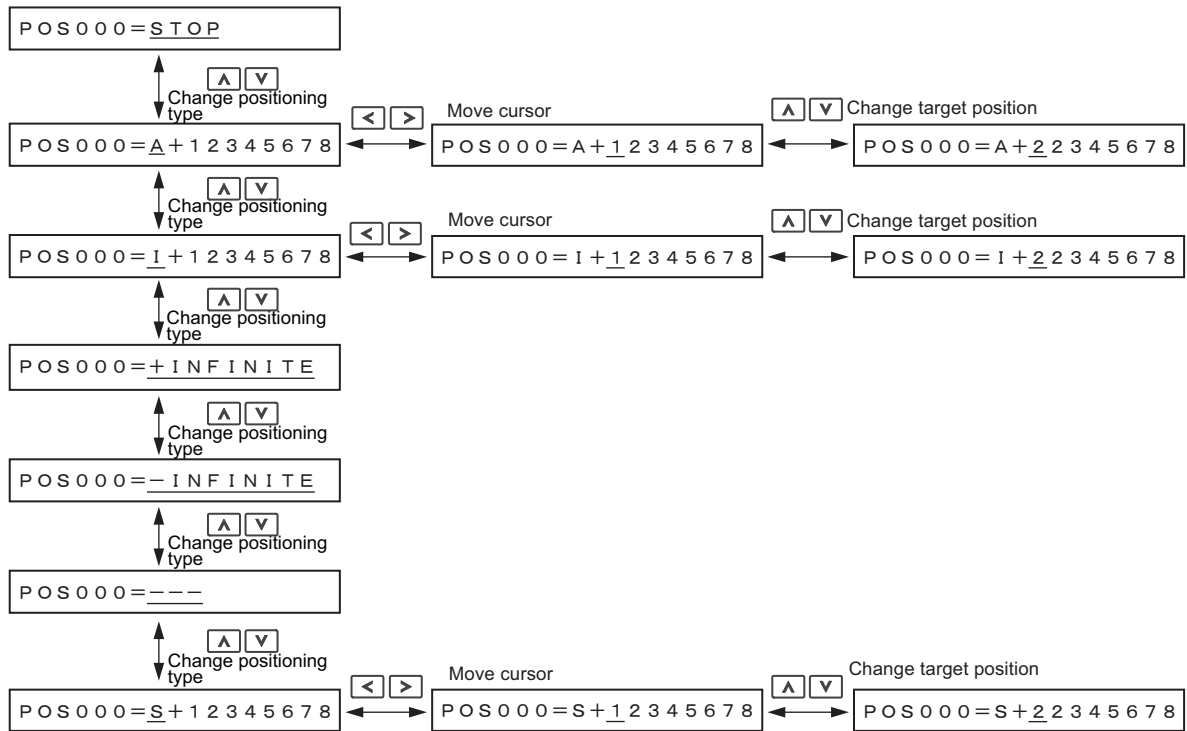

Note: Refer to the following section for details on positioning types and target positions.

☞ 13.3.5 *Settings in the Program Table* on page 13-13

■ SPD: Positioning Speed

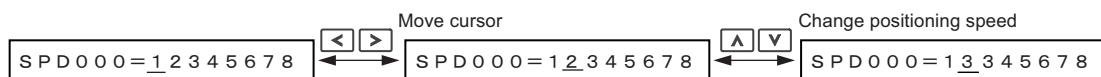

Note: Refer to the following section for details on the positioning speed.

☞ 13.3.5 *Settings in the Program Table* on page 13-13

■ RDST: Registration Distance

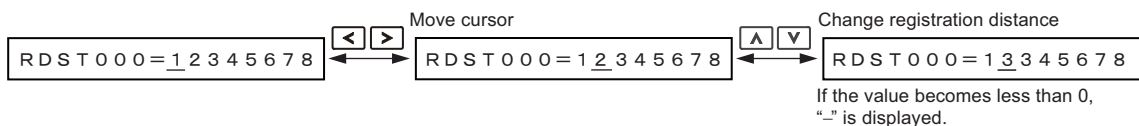

Note: Refer to the following section for details on the registration distance.

☞ 13.3.5 *Settings in the Program Table* on page 13-13

■ RSPD: Registration Speed

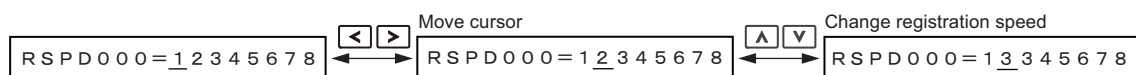

Note: Refer to the following section for details on the registration speed.

☞ 13.3.5 *Settings in the Program Table* on page 13-13

■ ACC: Acceleration

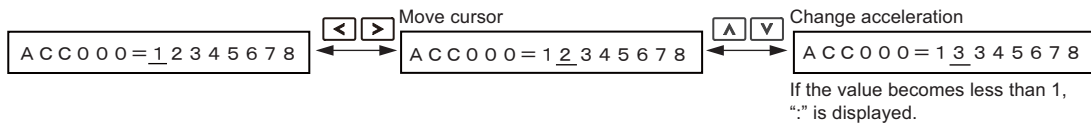

Note: Refer to the following section for details on the acceleration rate.
 13.3.5 Settings in the Program Table on page 13-13

■ DEC: Deceleration

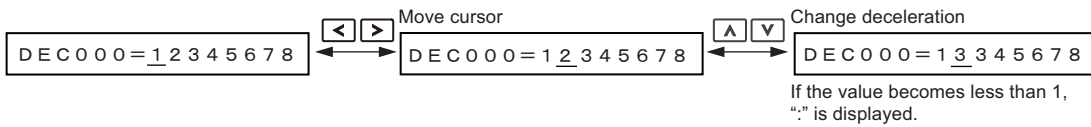

Note: Refer to the following section for details on the deceleration rate.
 13.3.5 Settings in the Program Table on page 13-13

■ POUT: Programmable Output Signals

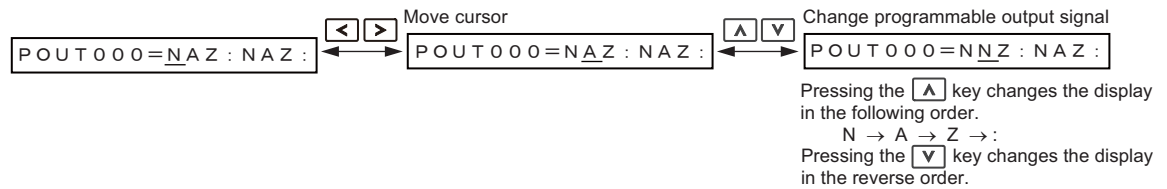

Note: Refer to the following section for details on the programmable output signals.
 13.3.5 Settings in the Program Table on page 13-13

■ EVENT: Pass Condition

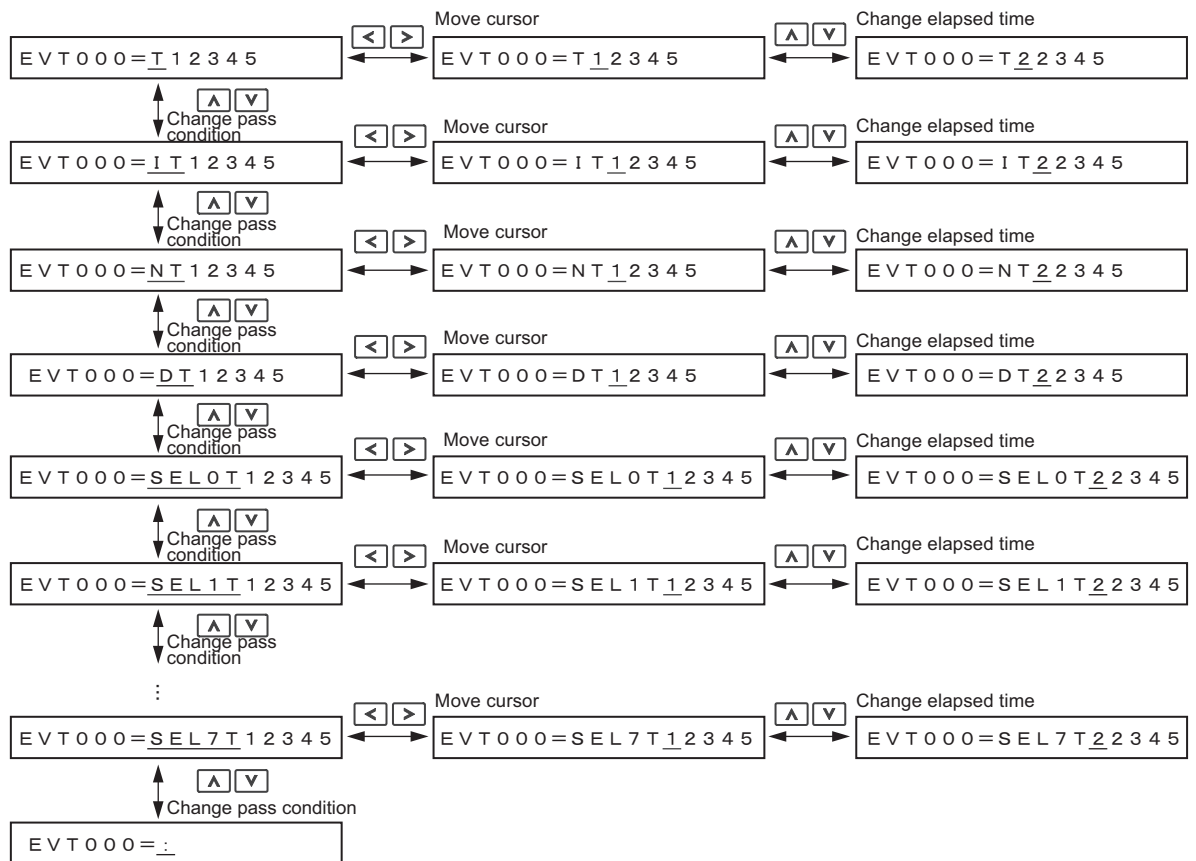

Note: Refer to the following section for details on the pass condition and elapsed time.
 13.3.5 Settings in the Program Table on page 13-13

■ LOOP: Number of Executions

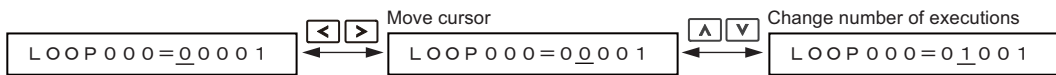

Note: Refer to the following section for details on the number of executions.
 13.3.5 Settings in the Program Table on page 13-13

■ NEXT: PGMSTEP to be Executed Next

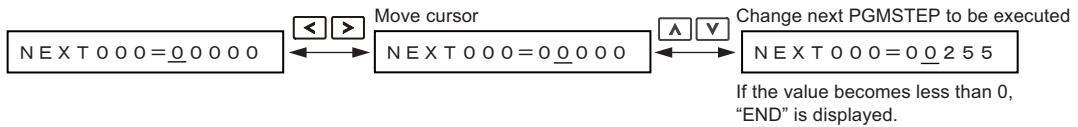

Note: Refer to the following section for details on the program step to execute next.
 13.3.5 Settings in the Program Table on page 13-13

◆ Saving Program Tables

The operating procedure for saving program tables is shown below.

Step	Display after Operation	Keys	Operation
1	<pre>BB -PGM Edit- POS000=STOP POS001=STOP POS002=STOP POS003=STOP</pre>	-	Display the program table editing screen.
2	<pre>BB -PGM Edit- STORE PGM TABLE? CANCEL STORE</pre>	WRITE	Press the key to view the program table save operation screen.
3	<pre>BB -PGM Edit- STORE PGM TABLE? CANCEL STORE</pre>		Move the cursor with the keys to select "STORE". Note: Selecting "CANCEL" and pressing the key will return the display to the program table editing screen.
4	<pre>BB -PGM Edit- Storing now... Please wait.</pre>		Press the key to start saving the program table to flash memory.* Do not turn off the control power supply until saving has been completed normally.
5	<pre>BB -PGM Edit- POS000=STOP POS001=STOP POS002=STOP POS003=STOP</pre>	-	When saving to flash memory has been completed normally, the display returns to the program table editing screen.
6	<pre>BB -FUNCTION- Fn207 V-Monitor FnB03 PGM Edit FnB04 ZONE Edit FnB05 JSPD Edit</pre>		Press the key to return to the Utility Function Mode main menu.

* If the key is pressed in an operation prohibited state, "Error." is displayed for approximately 2 seconds and then the display returns to the program table editing screen. In this case, make the setting again by referring to ◆ Preparation on page 17-11.

ZONE Table Edit/Save (FnB04)

This function edits and saves ZONE tables. Saving a ZONE table to flash memory after editing it ensures that the data will be retained even after the control power has been turned off.

■ Codes Displayed on the ZONE Table Editing Screen

For details on how to read the screen, refer to *Reading the Screen* on page 17-9.

ZONE Number	ZONE P	ZONE N
0	ZP000	ZN000
1	ZP001	ZN001
⋮	⋮	⋮
31	ZP031	ZN031































◆ Preparation

The following conditions must be met to edit and save ZONE tables.

- The write-prohibited setting (Fn010) must not be set to write-protect parameters.
- A ZONE table save operation must not be in progress for any means other than the digital operator.

◆ Editing ZONE Tables

The operating procedure when setting ZONE N in ZONE number 5 is explained here.

Step	Display after Operation	Keys	Operation
1	<pre>BB -FUNCTION- FnB03 PGM Edit FnB04 ZONE Edit FnB05 JSPD Edit FnB06 PGM Init</pre>	  	Press the  key to open the Utility Function Mode main menu, and move the cursor with the   keys to select FnB04.
2	<pre>BB -ZONE Edit- ZP000=+00000000 ZP001=+00000000 ZP002=+00000000 ZP003=+00000000</pre>		Press the  key to view the FnB04 operation screen.
3	<pre>BB -ZONE Edit- ZN002=+00000000 ZN003=+00000000 ZN004=+00000000 ZN005=+00000000</pre>	   	Move the cursor using the   keys and   keys to select the ZONE table number to be edited. Refer to the following section for details on the methods to move the cursor.  ■ <i>Method for Moving the Cursor</i> on page 17-13
4	<pre>BB -ZONE Edit- ZN002=+00000000 ZN003=+00000000 ZN004=+00000000 ZN005=+00000000</pre>		Press the  key to move the cursor to the setting side of the table.
5	<pre>BB -ZONE Edit- ZN002=+00000000 ZN003=+00000000 ZN004=+00000000 ZN005=+12345678</pre>	   	Move the cursor using the   keys and change the ZONE boundary values using the   keys.*
6	<pre>BB -ZONE Edit- ZN002=+00000000 ZN003=+00000000 ZN004=+00000000 ZN005=+12345678</pre>		On pressing the  key, the setting is entered and the cursor returns to the ZONE table number side.
7	Repeat steps 3 to 6 to set the ZONE table. On completing the setting of all the ZONE tables to be used, save the ZONE tables to flash memory by following the procedure in  <i>Saving ZONE Tables</i> on page 17-18.		

* If setting is attempted in an operation prohibited state, it will not be possible to change the setting. In this case, make the setting again by referring to  *Preparation* on page 17-17.

■ Method for Moving the Cursor

The values within the frames in the figure below are the ZONE table numbers displayed at the digital operator.

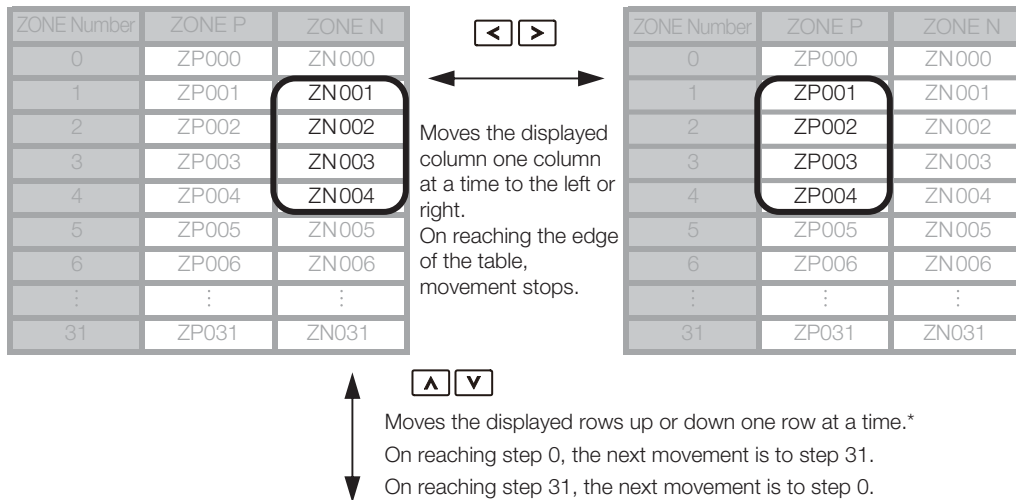

ZONE Number	ZONE P	ZONE N
0	ZP000	ZN000
1	ZP001	ZN001
2	ZP002	ZN002
3	ZP003	ZN003
4	ZP004	ZN004
5	ZP005	ZN005
6	ZP006	ZN006
⋮	⋮	⋮
31	ZP031	ZN031

* You can move 3 rows at a time by holding down the or key.



◆ Saving ZONE Tables



The operating procedure for saving ZONE tables is shown below.

Step	Display after Operation	Keys	Operation
1	<pre> BB -ZONE Edit- ZP000=+00000000 ZP001=+00000000 ZP002=+00000000 ZP003=+00000000 </pre>	-	Display the ZONE table editing screen.
2	<pre> BB -ZONE Edit- STORE ZONE TABLE? CANCEL STORE </pre>		Press the key to view the ZONE table save screen.
3	<pre> BB -ZONE Edit- STORE ZONE TABLE? CANCEL STORE </pre>		Move the cursor with the keys to select "STORE". Note: Selecting "CANCEL" and pressing the key will return the display to the ZONE table editing screen.
4	<pre> BB -ZONE Edit- Storing now... Please wait. </pre>		Press the key to start saving the ZONE table to flash memory.* Do not turn off the control power supply until saving has been completed normally.

Continued on next page.

Continued from previous page.

Step	Display after Operation	Keys	Operation
5	<pre>BB -ZONE Edit- ZP000=+00000000 ZP001=+00000000 ZP002=+00000000 ZP003=+00000000</pre>	-	When saving to flash memory has been completed normally, the display returns to the ZONE table editing screen.
6	<pre>BB -FUNCTION- FnB03 PGM Edit FnB04 ZONE Edit FnB05 JSPD Edit FnB06 PGM Init</pre>		Press the  key to return to the Utility Function Mode main menu.

* If the  key is pressed in an operation prohibited state, "Error." is displayed for approximately 2 seconds and then the display returns to the ZONE table editing screen. In this case, make the setting again by referring to  Preparation on page 17-17.

JOG Speed Table Edit/Save (FnB05)

This function edits and saves JOG speed tables. Saving a JOG speed table to flash memory after editing it ensures that the data will be retained even after the control power has been turned off.

Refer to the following section for information on interpreting the displays.

 Reading the Screen on page 17-9

























◆ Preparation

The following conditions must be met to save and edit JOG speed tables.

- The write-prohibited setting (Fn010) must not be set to write-protect parameters.
- A JOG speed table save operation must not be in progress for any means other than the digital operator.



◆ Editing JOG Speed Tables

The operating procedure when setting the value for JOG speed table number 5 is explained here.

Step	Display after Operation	Keys	Operation
1	<pre>BB -FUNCTION- FnB04 ZONE Edit FnB05 JSPD Edit FnB06 PGM Init FnB07 ZONE Init</pre>	  	Press the  key to open the Utility Function Mode main menu, and move the cursor with the   keys to select FnB05.
2	<pre>BB -JSPD Edit- JSPD000=00001000 JSPD001=00001000 JSPD002=00001000 JSPD003=00001000</pre>		Press the  key to view the FnB05 operation screen.
3	<pre>BB -JSPD Edit- JSPD002=00001000 JSPD003=00001000 JSPD004=00001000 JSPD005=00001000</pre>	 	Move the cursor using the   keys to select the JOG speed table number to be edited. Pressing the  key when the cursor is on JOG speed table number 0 moves it to number 15. Pressing the  key when the cursor is on JOG speed table number 15 moves it to number 0.
4	<pre>BB -JSPD Edit- JSPD002=00001000 JSPD003=00001000 JSPD004=00001000 JSPD005=00001000</pre>		Press the  key to move the cursor to the setting side of the table.
5	<pre>BB -JSPD Edit- JSPD002=00001000 JSPD003=00001000 JSPD004=00001000 JSPD005=12345678</pre>	   	Move the cursor with the   keys, and change the JOG speed setting with the   keys.*

Continued on next page.











Continued from previous page.

Step	Display after Operation	Keys	Operation
6	<pre> BB -JSPD Edit- JSPD002=00001000 JSPD003=00001000 JSPD004=00001000 JSPD005=12345678 </pre>		On pressing the  key, the setting is entered and the cursor returns to the JOG speed table number side.
7	Repeat steps 3 to 6 to set the JOG speed table. On completing the setting of all the JOG speed tables to be used, save the JOG speed tables to flash memory by following the procedure in ◆ Saving JOG Speed Tables on page 17-20.		

* If setting is attempted in an operation prohibited state, it will not be possible to change the setting. In this case, make the setting again by referring to **◆ Preparation** on page 17-19.

◆ Saving JOG Speed Tables

The operating procedure for saving JOG speed tables is shown below.

Step	Display after Operation	Keys	Operation
1	<pre> BB -JSPD Edit- JSPD000=00001000 JSPD001=00001000 JSPD002=00001000 JSPD003=00001000 </pre>	-	Display the JOG speed table editing screen.
2	<pre> BB -JSPD Edit- STORE JSPD TABLE? CANCEL STORE </pre>		Press the  key to view the JOG speed table save screen.
3	<pre> BB -JSPD Edit- STORE JSPD TABLE? CANCEL STORE </pre>	 	Move the cursor with the   keys to select "STORE". Note: Selecting "CANCEL" and pressing the  key will return the display to the JOG speed table editing screen.
4	<pre> BB -JSPD Edit- Storing now... Please wait. </pre>		Press the  key to start saving the JOG speed table to flash memory.* Do not turn off the control power supply until saving has been completed normally.
5	<pre> BB -JSPD Edit- JSPD000=00001000 JSPD001=00001000 JSPD002=00001000 JSPD003=00001000 </pre>	-	When saving to flash memory has been completed normally, the display returns to the JOG speed table editing screen.
6	<pre> BB -FUNCTION- FnB04 ZONE Edit FnB05 JSPD Edit FnB06 PGM Init FnB07 ZONE Init </pre>		Press the  key to return to the Utility Function Mode main menu.

* If the  key is pressed in an operation prohibited state, "Error." is displayed for approximately 2 seconds and then the display returns to the JOG speed table editing screen. In this case, make the setting again by referring to **◆ Preparation** on page 17-19.

Program Table Initialization (FnB06)















This function initializes the program tables and restores the settings on shipment from the factory.

◆ Preparation

The following conditions must be met to initialize the program table.

- The write-prohibited setting (Fn010) must not be set to write-protect parameters.
- The program must not be running or on hold.
- A program table save operation must not be in progress for any means other than the digital operator.
- Execution of the RES command must not be in progress.

◆ Operating Procedure

Step	Display after Operation	Keys	Operation
1	<pre> BB -FUNCTION- FnB05 JSPD Edit FnB06 PGM Init FnB07 ZONE Init FnB08 JSPD Init </pre>	  	Press the  key to open the Utility Function Mode main menu, and move the cursor with the   keys to select FnB06.
2	<pre> BB -PGM Init- Start : [DATA] Return : [SET] </pre>		Press the  key to view the FnB06 operation screen.
3	<pre> BB -PGM Init- Restoring now... Please wait. </pre>		Press the  key to start program table initialization.* Do not turn off the control power supply until initialization has been completed normally. To cancel the FnB06 operation, press the  key before pressing the  key. The display returns to the Utility Function Mode main menu without executing the operation.
4	<pre> BB -PGM Init- Done. Press [SET] key. </pre>	-	When program table initialization has been completed normally, "Done." is displayed.
5	<pre> BB -FUNCTION- FnB05 JSPD Edit FnB06 PGM Init FnB07 ZONE Init FnB08 JSPD Init </pre>		Press the  key to return to the Utility Function Mode main menu.

* If the  key is pressed in an operation prohibited state, "Error." is displayed for approximately 2 seconds and then the display returns to the FnB06 operation screen. In this case, make the setting again by referring to ◆ Preparation on page 17-21.

ZONE Table Initialization (FnB07)















This function initializes ZONE tables and restores the settings on shipment from the factory.

◆ Preparation

The following conditions must be met to initialize ZONE tables.

- The write-prohibited setting (Fn010) must not be set to write-protect parameters.
- A ZONE table save operation must not be in progress for any means other than the digital operator.
- Execution of the RES command must not be in progress.

◆ Operating Procedure

Step	Display after Operation	Keys	Operation
1	<pre> BB -FUNCTION- FnB06 PGM Init FnB07 ZONE Init FnB08 JSPD Init FnB09 ZSET </pre>	  	Press the  key to open the Utility Function Mode main menu, and move the cursor with the   keys to select FnB07.
2	<pre> BB -ZONE Init- Start : [DATA] Return : [SET] </pre>		Press the  key to view the FnB07 operation screen.
3	<pre> BB -ZONE Init- Restoring now... Please wait. </pre>		Press the  key to start ZONE table initialization.* Do not turn off the control power supply until initialization has been completed normally. To cancel the FnB07 operation, press the  key before pressing the  key. The display returns to the Utility Function Mode main menu without executing the operation.
4	<pre> BB -ZONE Init- Done. Press [SET] key. </pre>	-	When ZONE table initialization has been completed normally, "Done." is displayed.
5	<pre> BB -FUNCTION- FnB06 PGM Init FnB07 ZONE Init FnB08 JSPD Init FnB09 ZSET </pre>		Press the  key to return to the Utility Function Mode main menu.

* If the  key is pressed in an operation prohibited state, "Error." is displayed for approximately 2 seconds and then the display returns to the FnB07 operation screen. In this case, make the setting again by referring to ◆ Preparation on page 17-22.

JOG Speed Table Initialization (FnB08)















This function initializes JOG speed tables and restores the default settings.

◆ Preparation

The following conditions must be met to initialize JOG speed tables.

- The write-prohibited setting (Fn010) must not be set to write-protect parameters.
- A JOG speed table save operation must not be in progress for any means other than the digital operator.
- Execution of the RES command must not be in progress.

◆ Operating Procedure

Step	Display after Operation	Keys	Operation
1	<pre>BB -FUNCTION- FnB07 ZONE Init FnB08 JSPD Init FnB09 ZSET FnB0A Monitor</pre>	  	Press the  key to open the Utility Function Mode main menu, and move the cursor with the   keys to select FnB08.
2	<pre>BB -JSPD Init- Start : [DATA] Return: [SET]</pre>		Press the  key to view the FnB08 operation screen.
3	<pre>BB -JSPD Init- Restoring now... Please wait.</pre>		Press the  key to start JOG speed table initialization.* Do not turn off the control power supply until initialization has been completed normally. To cancel the FnB08 operation, press the  key before pressing the  key. The display returns to the Utility Function Mode main menu without executing the operation.
4	<pre>BB -JSPD Init- Done. Press [SET] key.</pre>	-	When JOG speed table initialization has been completed normally, "Done." is displayed.
5	<pre>BB -FUNCTION- FnB07 ZONE Init FnB08 JSPD Init FnB09 ZSET FnB0A Monitor</pre>		Press the  key to return to the Utility Function Mode main menu.

* If the  key is pressed in an operation prohibited state, "Error." is displayed for approximately 2 seconds and then the display returns to the FnB08 operation screen. In this case, make the setting again by referring to **◆ Preparation** on page 17-23.

Absolute Encoder Origin Setting (FnB09)

This utility function replaces the current position with a specified position. Also updates PnB25 with the absolute position offset value to achieve the position specified by this utility function.

DANGER

- This function replaces the coordinates of the reference position and is therefore very dangerous. After executing this function, check that the new coordinates match the reference position before starting operation.

Important

- If the settings for any of parameters Pn20E to Pn210, Pn205, or PnB20 to PnB25 have been changed, turn the control power supply off and back on to bring the settings into effect before executing operation.
- The absolute position offset value is saved in parameter PnB25, so do not rewrite this value.

◆ Preparation

The following conditions must be met to perform the absolute encoder origin setting.

- The write-prohibited setting (Fn010) must not be set to write-protect parameters.
- Distribution of position references must not be in progress.
- The absolute position offset value must not be outside the range for PnB25.
- An absolute encoder must be connected and Pn002 must be set to n.□0□□.

◆ Operating Procedure

Step	Display after Operation	Keys	Operation
1	<pre>BB -FUNCTION- FnB08 JSPD Init FnB09 ZSET FnB0A Monitor FnB0B Prm Init</pre>	 	Press the key to open the Utility Function Mode main menu, and move the cursor with the keys to select FnB09.
2	<pre>BB -ZSET- Pos=+00000000 Start : [DATA] Return: [SET]</pre>		Press the key to view the FnB09 operation screen.
3	<pre>BB -ZSET- Pos=+00001000 Start : [DATA] Return: [SET]</pre>	 	Move the cursor with the keys, and change the setting for the position whose current position is to be replaced with the keys.
4	<pre>BB -ZSET- Storing now...</pre>		Press the key to start origin setting.* Do not turn off the control power supply until origin setting has been completed normally. To cancel the FnB09 operation, press the key before pressing the key. The display returns to the Utility Function Mode main menu without executing the operation.
5	<pre>BB -ZSET- Done. Press [SET] key.</pre>	-	When origin setting has been completed normally, "Done." is displayed.
6	<pre>BB -FUNCTION- FnB08 JSPD Init FnB09 ZSET FnB0A Monitor FnB0B Prm Init</pre>		Press the key to return to the Utility Function Mode main menu.
7	Check that the current distributed position (PUN) and the current (actual) motor position (PFB) have changed to the specified positions by executing FnB0A.		

* If the key is pressed in an operation prohibited state, "Error." is displayed for approximately 2 seconds and then the display returns to the FnB09 operation screen. In this case, make the setting again by referring to ◆ Preparation on page 17-24.

















INDEXER Status Monitor (FnB0A)

This function shows the internal status of the INDEXER Module, such as the current position and input/output signals.

◆ Preparation

None

◆ Operating Procedure





Step	Display after Operation	Keys	Operation
1	<pre> BB -FUNCTION- FnB09 ZSET FnB0A Monitor FnB0B Prm Init FnB0C ALM Reset </pre>	  	Press the  key to open the Utility Function Mode main menu, and move the cursor with the   keys to select FnB0A.
2	<pre> BB -MONITOR- ALM=BB ERR=NONE PFB=+12345678 PGMSTEP=12345 </pre>		Press the  key to view the FnB0A operation screen.
3	<pre> BB -MONITOR- STS=■ ■ ■ ■ ■ ■ ■ ■ ■ ■ PUN=+12345678 PFB=+12345678 POS=+12345678 </pre>	 	Use the   keys to change the monitor display content. Note: Press the  key to change the content being displayed in the following order. ALM → ERR → IN2 → OUT2 → STS → PUN → PFB → POS → DST → RPOS → RDST → PGMSTEP → EVTIME → LOOP Press the  key to change the content being displayed in the reverse order.
4	<pre> BB -FUNCTION- FnB09 ZSET FnB0A Monitor FnB0B Prm Init FnB0C ALM Reset </pre>		Press the  key to return to the Utility Function Mode main menu.

■ Monitor Display Content List

Display Code	Display Content	Display Example	Units	Serial Command
ALM	Alarm or Warning	<ul style="list-style-type: none"> • ALM = A.xxx: A SERVOPACK alarm/warning is in effect (xxx is the alarm/warning code). • ALM = ExxA: An INDEXER Module alarm is in effect (ExxA is the alarm code). • ALM = HBB: During hard wire base block • ALM = P-OT: Forward run prohibited (Over travel) • ALM = N-OT: Reverse run prohibited (Over travel) • ALM = P-LS: Forward software limit • ALM = N-LS: Reverse software limit • ALM = BB: Base blocked • ALM = HOLD: Positioning interrupted • ALM = INPOS: Positioning completed • ALM = NEAR: Near position status reached in positioning • ALM = RUN: Motor running • ALM = . : Status other than above 	-	ALM

Continued on next page.

Continued from previous page.

Display Code	Display Content	Display Example	Units	Serial Command																								
ERR	Most Recent (Closest) Error	<ul style="list-style-type: none"> • ERR = NONE: No error • ERR = ExxE: Error code 	-	ERR																								
IN2	INDEXER Module Input Signal	<p>IN2 = </p> <p> 1110 9 8 7 6 5 4 3 2 1 digit</p> <p>Upper level: Photocoupler ON Lower level: Photocoupler OFF</p> <table border="1"> <thead> <tr> <th>Display Digit Number</th> <th>Signal Name</th> </tr> </thead> <tbody> <tr><td>1</td><td>/MODE0/1</td></tr> <tr><td>2</td><td>/START-STOP; /HOME</td></tr> <tr><td>3</td><td>/PGMRES; /JOGP</td></tr> <tr><td>4</td><td>/SEL0; /JOGN</td></tr> <tr><td>5</td><td>/SEL1; /JOG0</td></tr> <tr><td>6</td><td>/SEL2; /JOG1</td></tr> <tr><td>7</td><td>/SEL3; /JOG2</td></tr> <tr><td>8</td><td>/SEL4; /JOG3</td></tr> <tr><td>9</td><td>/SEL5</td></tr> <tr><td>10</td><td>/SEL6</td></tr> <tr><td>11</td><td>/SEL7</td></tr> </tbody> </table>	Display Digit Number	Signal Name	1	/MODE0/1	2	/START-STOP; /HOME	3	/PGMRES; /JOGP	4	/SEL0; /JOGN	5	/SEL1; /JOG0	6	/SEL2; /JOG1	7	/SEL3; /JOG2	8	/SEL4; /JOG3	9	/SEL5	10	/SEL6	11	/SEL7	-	IN2
Display Digit Number	Signal Name																											
1	/MODE0/1																											
2	/START-STOP; /HOME																											
3	/PGMRES; /JOGP																											
4	/SEL0; /JOGN																											
5	/SEL1; /JOG0																											
6	/SEL2; /JOG1																											
7	/SEL3; /JOG2																											
8	/SEL4; /JOG3																											
9	/SEL5																											
10	/SEL6																											
11	/SEL7																											
OUT2	INDEXER Module Output Signal	<p>OUT2 = </p> <p> 9 8 7 6 5 4 3 2 1 digit</p> <p>Upper level: Photocoupler ON Lower level: Photocoupler OFF</p> <table border="1"> <thead> <tr> <th>Display Digit Number</th> <th>Signal Name</th> </tr> </thead> <tbody> <tr><td>1</td><td>/INPOSITION</td></tr> <tr><td>2</td><td>/POUT0</td></tr> <tr><td>3</td><td>/POUT1</td></tr> <tr><td>4</td><td>/POUT2</td></tr> <tr><td>5</td><td>/POUT3</td></tr> <tr><td>6</td><td>/POUT4</td></tr> <tr><td>7</td><td>/POUT5</td></tr> <tr><td>8</td><td>/POUT6</td></tr> <tr><td>9</td><td>/POUT7</td></tr> </tbody> </table>	Display Digit Number	Signal Name	1	/INPOSITION	2	/POUT0	3	/POUT1	4	/POUT2	5	/POUT3	6	/POUT4	7	/POUT5	8	/POUT6	9	/POUT7	-	OUT2				
Display Digit Number	Signal Name																											
1	/INPOSITION																											
2	/POUT0																											
3	/POUT1																											
4	/POUT2																											
5	/POUT3																											
6	/POUT4																											
7	/POUT5																											
8	/POUT6																											
9	/POUT7																											

Continued on next page.

Continued from previous page.

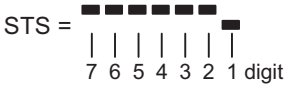
Display Code	Display Content	Display Example	Units	Serial Command																
STS	Status Flag	STS =  Upper level: ON Lower level: OFF	-	STS																
		<table border="1"> <thead> <tr> <th>Display Digit Number</th> <th>Status Flag</th> </tr> </thead> <tbody> <tr> <td>1</td> <td>INPOSITION (Positioning complete)</td> </tr> <tr> <td>2</td> <td>NEAR (Near position)</td> </tr> <tr> <td>3</td> <td>DEN (positioning reference distribution completed)</td> </tr> <tr> <td>4</td> <td>When positioning or program operation is interrupted (on hold)</td> </tr> <tr> <td>5</td> <td>During program operation</td> </tr> <tr> <td>6</td> <td>When the current (torque) is being limited</td> </tr> <tr> <td>7</td> <td>When the main power supply is ON</td> </tr> </tbody> </table>			Display Digit Number	Status Flag	1	INPOSITION (Positioning complete)	2	NEAR (Near position)	3	DEN (positioning reference distribution completed)	4	When positioning or program operation is interrupted (on hold)	5	During program operation	6	When the current (torque) is being limited	7	When the main power supply is ON
		Display Digit Number			Status Flag															
		1			INPOSITION (Positioning complete)															
		2			NEAR (Near position)															
		3			DEN (positioning reference distribution completed)															
		4			When positioning or program operation is interrupted (on hold)															
		5			During program operation															
6	When the current (torque) is being limited																			
7	When the main power supply is ON																			
PUN	Position Reference Current Position	PUN = +12345678	Reference unit	PUN																
PFB	Current (Actual) Motor Position	PFB = +12345678	Reference unit	PFB																
POS	Target Position	POS = +12345678	Reference unit	POS																
DST	Target Distance	DST = +12345678	Reference unit	DST																
RPOS	Registration Target Position	RPOS = +12345678	Reference unit	RPOS																
RDST	Registration Target Distance	RDST = 12345678	Reference unit	RDST																
PGMSTEP	Program Step (PGMSTEP)	PGMSTEP = End: When the program is not running PGMSTEP = 12345: The program step being executed	-	PGMSTEP																
EVTIME	Program EVENT Elapsed Time	EVTIME = 12345	ms	EVTIME																
LOOP	Loop Pass Through	LOOP = 12345	Times	LOOP																

INDEXER Parameter Setting Initialization (FnB0B)

This function restores the default settings and initializes the parameters of both the SERVOPACK and the INDEXER Module.



Important















- Always carry out initialization of the parameter settings in the servo OFF status. It cannot be done in the servo ON status.
- To bring the settings into effect, always turn the SERVOPACK power supply off and back on after this operation.
- When you execute Fn005, only the SERVOPACK parameters are initialized. The INDEXER Module parameters are not initialized. To initialize the INDEXER Module parameters, execute FnB0B.

◆ Preparation

The following conditions must be met to initialize INDEXER parameter settings.

- The write-prohibited setting (Fn010) must not be set to write-protect parameters.
- The servo OFF status must be established.
- Initializing the parameter settings must not be in progress for any tool.
- The RES command must not be executed.

◆ Operating Procedure

Step	Display after Operation	Keys	Operation
1	<pre>BB -FUNCTION- FnB0A Monitor FnB0B Prm Init FnB0C ALM Reset FnB0D Indexer ALM</pre>	  	Press the  key to open the Utility Function Mode main menu, and move the cursor with the   keys to select FnB0B.
2	<pre>BB -Prm Init- Start : [DATA] Return: [SET]</pre>		Press the  key to view the FnB0B operation screen.
3	<pre>BB -Prm Init- Restoring now... Please wait.</pre>		<p>Press the  key to start initialization of the parameters.* Do not turn off the control power supply until initialization has been completed normally.</p> <p>To cancel the FnB0B operation, press the  key before pressing the  key. The display returns to the Utility Function Mode main menu without executing the operation.</p>
4	<pre>BB -Prm Init- Done. Press [SET] key.</pre>	-	When parameter initialization has been completed normally, "Done." is displayed.
5	<pre>BB -FUNCTION- FnB0A Monitor FnB0B Prm Init FnB0C ALM Reset FnB0D Indexer ALM</pre>		Press the  key to return to the Utility Function Mode main menu.
6	To bring the settings into effect, turn the SERVOPACK power supply off and back on.		

* If the  key is pressed in an operation prohibited state, "Error." is displayed for approximately 2 seconds and then the display returns to the FnB0B operation screen. In this case, make the setting again by referring to **◆ Preparation** on page 17-28.

INDEXER Alarm Reset (FnB0C)

This function resets alarms at both the SERVOPACK and INDEXER Module, and clears the alarm history at the INDEXER Module.



Important

- INDEXER Module alarms are not reset by the “ALARM RESET” button of the digital operator. To reset INDEXER Module alarms, execute alarm resetting with FnB0C.
- Eliminate the causes of alarms before resetting them.
- When you execute Fn006, only the SERVOPACK alarm history is cleared. The INDEXER Module alarm history is not cleared. To clear the INDEXER Module alarm history, execute alarm history clearance with FnB0C.

◆ Preparation

■ When Resetting Alarms

None

■ When Clearing the Alarm History

The following conditions must be met to reset INDEXER alarms.



- The write-prohibited setting (Fn010) must not be set to write-protect parameters.
- The ALMTRCCLR command must not be executed.
- The RES command must not be executed.



◆ Operating Procedure

Step	Display after Operation	Keys	Operation
1	A. AEF -FUNCTION- FnB0B Prm Init FnB0C ALM Reset FnB0D Indexer ALM Fn000 Alm History	 	Press the key to open the Utility Function Mode main menu, and move the cursor with the keys to select FnB0C.
2	A. AEF -ALM Reset- Mode=ALM state Start : [DATA] Return : [SET]		Press the key to view the FnB0C operation screen.
3-1	A. AEF -ALM Reset- Mode=ALM state Start : [DATA] Return : [SET]		<p>■ When Resetting Alarms Use the keys to select “ALM state”.</p>
3-2	A. AEF -ALM Reset- Mode=ALM History Start : [DATA] Return : [SET]		<p>■ When Clearing the Alarm History Use the keys to select “ALM History”.</p>
4	A. AEF -ALM Reset- Resetting...		<p>Press the key to reset the alarms or clear the alarm history.*</p> <p>To cancel the FnB0C operation, press the key before pressing the key. The display returns to the Utility Function Mode main menu without executing the operation.</p>
5	BB -ALM Reset- Mode=ALM state Start : [DATA] Return : [SET]	-	When alarm resetting or alarm history clearance is completed, the display returns to the Mode selection screen.

Continued on next page.

Continued from previous page.

Step	Display after Operation	Keys	Operation
6	<pre> BB -FUNCTION- FnB0B Prm Init <u>FnB0C ALM Reset</u> FnB0D Indexer ALM Fn000 Alm History </pre>		Press the  key to return to the Utility Function Mode main menu.

* If the  key is pressed in an operation prohibited state, "Error." is displayed for approximately 2 seconds and then the display returns to the FnB0C operation screen. In this case, make the setting again by referring to  *Preparation*.















INDEXER Alarm History Display (FnB0D)

This function displays the history of alarms that have occurred at the SERVOPACK and INDEXER Module.

◆ Preparation

None

◆ Operating Procedure

Step	Display after Operation	Keys	Operation
1	<pre> BB -FUNCTION- FnB0C ALM Reset <u>FnB0D Indexer ALM</u> Fn000 Alm History Fn002 JOG </pre>	  	Press the  key to open the Utility Function Mode main menu, and move the cursor with the   keys to select FnB0D.
2	<pre> BB -ALM Trace- ALM0=A. F10 ALM1=E19A ALM2=NONE ALM3=NONE </pre>		Press the  key to view the alarm history. If no alarms occur, "NONE" is displayed.
3	<pre> BB -ALM Trace- ALM0=A. F10 ALM1=E19A ALM2=NONE ALM3=NONE ALM4=NONE </pre> <pre> BB -ALM Trace- ALM1=E19A ALM2=NONE ALM3=NONE ALM4=NONE </pre> <pre> BB -ALM Trace- ALM6=NONE ALM7=NONE ALM8=NONE ALM9=NONE </pre>	 	Use the   keys to scroll the alarm history.
4	<pre> BB -FUNCTION- FnB0C ALM Reset <u>FnB0D Indexer ALM</u> Fn000 Alm History Fn002 JOG </pre>		Press the  key to return to the Utility Function Mode main menu.

Information

To clear the alarm history, execute the Reset INDEXER Alarm (FnB0C) utility function with *Mode* set to *ALM History* (clear alarm history). The alarm history is not cleared when you reset an alarm (*Mode* = *ALM* state) or when the control power supply to the SERVOPACK is turned OFF. Refer to the following section for the procedure.

 *INDEXER Alarm Reset (FnB0C)* on page 17-29

17.3 Alphabetical List of Serial Commands

The following table lists the usable serial commands in alphabetical order.

Serial Command	Function	Reference
ABSPGRES	Absolute Encoder Reset	page 14-30
ACCnnnnnnnn	Acceleration Specification	page 14-15
ACCTsss	Program Table ACC Read	page 14-24
ACCTsss=	Program Table ACC Write	page 14-24
ALM	Alarm or Warning Read	page 14-30
ALMn	Alarm History Read	page 14-30
ALMTRCCLR	Alarm Trace Clear	page 14-30
ARES	Alarm Reset	page 14-11
CURZERO	Motor Current Zero Adjustment	page 14-30
DBRMS	Dynamic-Brake Load Ratio Monitor	page 14-30
DECnnnnnnnn	Deceleration Specification	page 14-15
DECTsss	Program Table DEC Read	page 14-24
DECTsss=	Program Table DEC Write	page 14-24
DST or MON9	Target Distance Monitor	page 14-30
ERR	Most Recent Error Read	page 14-30
EVENTTsss	Program Table EVENT Read	page 14-24
EVENTTsss=	Program Table EVENT Write	page 14-24
EVTIME	Program EVENT Elapsed Time Monitor	page 14-30
HALLSENS	Hall Sensor Monitor For Linear Servomotors	page 14-30
HOLD	Positioning Interruption	page 14-15
IN1	SERVOPACK Input Signal Monitor (CN1)	page 14-30
IN2	INDEXER Module Input Signal Monitor (CN11)	page 14-30
IN2TESTbbbbbbbbbb	INDEXER Module Input Signal Specification (CN11)	page 14-30
IN3	Safety Function Input Signal Monitor	page 14-30
JOGPnnnnnnnn	JOG Forward	page 14-15
JOGNnnnnnnnn	JOG Reverse	page 14-15
JSPDINIT	JOG Speed Table Initialization	page 14-29
JSPDSTORE	JOG Speed Table Save	page 14-29
JSPDTdd	JOG Speed Table Read	page 14-29
JSPDTdd=	JOG Speed Table Write	page 14-29
LOOP	Program Table LOOP Pass Through Monitor	page 14-30
LOOPTsss	Program Table LOOP Read	page 14-24
LOOPTsss=	Program Table LOOP Write	page 14-24
MLTLIMSET	Multi-turn Limit Setting	page 14-30
MONn	Monitor Read	page 14-30
MTSIZE	Monitor Capacity Display	page 14-30
MTTYPE	Motor Model Code Display	page 14-30
NEXTTsss	Program Table NEXT Read	page 14-24
NEXTTsss=	Program Table NEXT Write	page 14-24
NFB or MON3	Motor Speed Monitor	page 14-30
NREF or MON4	Speed Reference Monitor	page 14-30
OUT1	SERVOPACK Output Signal Monitor (CN1)	page 14-30
OUT2	INDEXER Module Output Signal Monitor (CN11)	page 14-30
OUT2TESTbbbbbbbbbb	INDEXER Module Output Signal Specification (CN11)	page 14-30
PER or MON2	Position Error Monitor	page 14-30
PFB or MON7	Current (Actual) Motor Position Monitor	page 14-30
PGMINIT	Program Table Initialization	page 14-24

Continued on next page.

Continued from previous page.

Serial Command	Function	Reference
PGMRES	Program Table Operation Reset	page 14-28
PGMSTEP	Program Step (PGMSTEP) Monitor	page 14-30
PGMSTORE	Program Table Save	page 14-24
PGTYPE	Encoder Model Code Display	page 14-30
PGVER	Encoder Firmware Version Display	page 14-30
POS (\pm) nnnnnnnn POSA (\pm) nnnnnnnn	Target Position Specification (Absolute Position)	page 14-15
POS or MON8	Target Position Monitor	page 14-30
POSI (\pm) nnnnnnnn	Target Position Specification (Relative Distance)	page 14-15
POSTsss	Program Table POS Read	page 14-24
POSTsss=	Program Table POS Write	page 14-24
POUT	POUT Monitor	page 14-30
POUTnnnnnnnn	POUT Specification	page 14-15
POUTTsss	Program Table POUT Read	page 14-24
POUTTsss=	Program Table POUT Write	page 14-24
PRMINIT	Parameter Initialization	page 14-30
PRMppp	Parameter Read	page 14-30
PRMppp=	Parameter Write	page 14-30
PUN or MON1	Position Reference Current Position	page 14-30
RDST or MON11	Registration Target Distance Monitor	page 14-30
RDSTnnnnnnnn	Registration Distance Specification	page 14-15
RDSTTsss	Program Table RDST Read	page 14-24
RDSTTsss=	Program Table RDST Write	page 14-24
RES	Reset	page 14-11
RGRMS	Regeneration Load Ratio Monitor	page 14-30
RPOS or MON10	Registration Target Position Monitor	page 14-30
RS	Positioning Start with Registration	page 14-15
RS (\pm) nnnnnnnn RSA (\pm) nnnnnnnn	Positioning Start with Registration (Absolute Position)	page 14-15
RSI (\pm) nnnnnnnn	Positioning Start with Registration (Relative Distance)	page 14-15
RSPDnnnnnnnn	Registration Speed Specification	page 14-15
RSPDTsss	Program Table RSPD Read	page 14-24
RSPDTsss=	Program Table RSPD Write	page 14-24
SKIP	Positioning Stop	page 14-15
SPDnnnnnnnn	Positioning Speed Specification	page 14-15
SPDTsss	Program Table SPD Read	page 14-24
SPDTsss=	Program Table SPD Write	page 14-24
ST	Positioning Start	page 14-15
ST (\pm) nnnnnnnn STA (\pm) nnnnnnnn	Positioning Start (Absolute Position)	page 14-15
START	Program Table Operation Restart	page 14-28
STARTsss	Program Table Operation Start	page 14-28
STI (\pm) nnnnnnnn	Positioning Start (Relative Position)	page 14-15
STOP	Program Table Operation Interruption	page 14-28
STS or MON6	Status Flag Monitor	page 14-30
SVOFF	Servo OFF	page 14-11
SVON	Servo ON	page 14-11
SVTYPE	SERVOPACK Model Code Display	page 14-30
SVVER	SERVOPACK Firmware Version Display	page 14-30
SVYSPEC	SERVOPACK Special Specification No. Display	page 14-30
TREF or MON5	Internal Torque Reference Monitor	page 14-30

Continued on next page.

Continued from previous page.

Serial Command	Function	Reference
TRMppp=	Temporary Parameter Write	page 14-30
TRMS	Cumulative Load Ratio Monitor	page 14-30
TYPE	INDEXER Module Model Code Display	page 14-30
VER	INDEXER Module Firmware Version Display	page 14-30
YSPEC	INDEXER Module Special Specification No. Display	page 14-30
ZONEINIT	ZONE Table Initialization	page 14-29
ZONENTzz	ZONE Table ZONE N Read	page 14-29
ZONENTzz=	ZONE Table ZONE N Write	page 14-29
ZONEPTzz	ZONE table ZONE P Read	page 14-29
ZONEPTzz=	ZONE Table ZONE P Write	page 14-29
ZONESTORE	ZONE Table Save	page 14-29
ZRN	Homing Start	page 14-15
ZSET (±) nnnnnnn	Coordinates Setting	page 14-15

17.4 Corresponding Parameter Numbers

The following table shows the corresponding parameters between the SGD-V-OCA03A INDEXER Module and the INDEXER Module for SGDH SERVOPACKs (JUSP-NS600).

Parameter Name	SGDV-OCA03A Parameter No.	JUSP-NS600 Parameter No.
Axis Address Selection	Pn010 (setting range: 1 to F)	Rotary Switch (ADRS)
Serial Communication Protocol	PnB00	Pn800
Bit rate	PnB01	Pn801
Response "OK"	PnB02	Pn802
/MODE 0/1	PnB03	Pn803
/START-STOP; /HOME	PnB04	Pn804
/PGMRES; /JOGP	PnB05	Pn805
/SEL0; /JOGN	PnB06	Pn806
/SEL1; /JOG0	PnB07	Pn807
/SEL2; /JOG1	PnB08	Pn808
/SEL3; /JOG2	PnB09	Pn809
/SEL4; /JOG3	PnB0A	Pn80A
/SEL5	PnB0B	Pn833
/SEL6	PnB0C	Pn834
/SEL7	PnB0D	–
/S-ON	PnB0E	Pn80B
P-OT	PnB0F	Pn80C
N-OT	PnB10	Pn80D
/DEC	PnB11	Pn80E
/RGRT	PnB12	Pn80F
/INPOSITION	PnB13	Pn810
/POUT0	PnB14	Pn811
/POUT1	PnB15	Pn812
/POUT2	PnB16	Pn813
/POUT3	PnB17	Pn814
/POUT4	PnB18	Pn815
/POUT5	PnB19	–
/POUT6	PnB1A	–
/POUT7	PnB1B	–
/WARN	PnB1C	Pn816
/BK	PnB1D	Pn817
/S-RDY	PnB1E	Pn818
Overtravel (OT) Stop Method	PnB1F	Pn819
Moving Mode	PnB20	Pn81A
<ul style="list-style-type: none"> Linear coordinates (PnB20 = 0): Forward Software Limit (P-LS) Rotational coordinates (PnB20 ≠ 0): Last Rotational Coordinate 	PnB21 (PnB22)	Pn81B
<ul style="list-style-type: none"> Linear coordinates (PnB20 = 0): Reverse Software Limit (N-LS) Rotational coordinates (PnB20 ≠ 0): First Rotational Coordinate 	PnB23 (PnB24)	Pn81C
<ul style="list-style-type: none"> When using an incremental encoder: Origin When using an absolute encoder: Absolute Encoder Offset 	PnB25 (PnB26)	Pn81D
Positioning/Registration Speed	PnB27 (PnB28)	Pn81E

Continued on next page.

Continued from previous page.

Parameter Name	SGDV-OCA03A Parameter No.	JUSP-NS600 Parameter No.
Acceleration rate	PnB29 (PnB2A)	Pn81F
Deceleration rate	PnB2B (PnB2C)	Pn820
/INPOSITION Width	PnB2D (PnB2E)	Pn821
/NEAR Width	PnB2F (PnB30)	Pn822
Homing Method	PnB31	Pn823
Homing Direction	PnB32	Pn824
Homing Moving Speed	PnB33 (PnB34)	Pn825
Homing Approach Speed	PnB35 (PnB36)	Pn826
Homing Creep Speed	PnB37 (PnB38)	Pn827
Homing Final Move Distance	PnB39 (PnB3A)	Pn828
Reserved (setup information)	PnB3B (PnB3C)	Pn829
Reserved (setup information)	PnB3D (PnB3E)	Pn82A
Reserved (setup information)	PnB3F (PnB40)	Pn82B
Reserved (setup information)	PnB41 (PnB42)	Pn82C
Reserved (setup information)	PnB43 (PnB44)	Pn82D
Reserved (setup information)	PnB45 (PnB46)	Pn82E
Reserved (setup information)	PnB47 (PnB48)	Pn82F
Reserved (setup information)	PnB49 (PnB4A)	Pn830
Reserved (setup information)	PnB4B (PnB4C)	Pn831
Reserved (setup information)	PnB4D (PnB4E)	Pn832
ZONE Signal Setting	PnB4F	Pn835
Backlash Compensation	PnB50	Pn836
/ALO Output Selection	PnB51	–
/ALM-RST	PnB52	–
Input Signal Monitor IN1 Polarity Selection	PnB53	–

Index

Symbols

- * (global address) - - - - - 14-8
- /ALM-RST - - - - - 15-50
- /ALO1 to /ALO3- - - - - 6-7
- /BK - - - - - 5-32
- /COIN (Positioning Completion Output) Signal - - - - - 8-65
- /DEC - - - - - 6-3, 14-12
- /HOME- - - - - 4-40, 4-42, 6-5
- /HWBB1 - - - - - 4-49
- /HWBB2 - - - - - 4-49
- /INPOSITION - - - - - 4-41, 4-42, 6-9
- /JOG0 to /JOG3 - - - - - 4-40, 4-42, 6-6
- /JOGN - - - - - 4-40, 6-6
- /JOGP - - - - - 4-40, 4-42, 6-6
- /MODE 0/1 - - - - - 4-40, 4-42, 6-4
- /PGMRES - - - - - 4-40, 4-42, 6-5
- /POUT0 to /POUT7- - - - - 4-41, 4-42, 6-10
- /RGRT - - - - - 6-4, 14-21
- /SEL0 to /SEL7 - - - - - 4-40, 4-42, 6-7
- /S-ON - - - - - 6-3
- /S-RDY- - - - - 6-9
- /START-STOP - - - - - 4-40, 4-42, 6-4
- /WARN - - - - - 6-8
- /Z0 to /Z4 - - - - - 6-10
- +24V/COM - - - - - 4-40

A

- A.CC0 - - - - - 6-26
- absolute encoder - - - - - 6-23, 14-13, 14-14
 - offset- - - - - 12-6
 - origin setting - - - - - 17-24
 - reset - - - - - 14-36
 - resetting - - - - - 5-48
 - wiring - - - - - 4-27
- AC power supply input
 - setting - - - - - 5-12
- AC Reactor
 - wiring - - - - - 4-25
- ACC - - - - - 13-13
- acceleration - - - - - 14-16
- Acceleration Rate- - - - - 12-4
- additional adjustment functions - - - - - 8-64
- alarm code output - - - - - 6-7
- alarm tracing - - - - - 9-17

alarms

- alarm reset - - - - - 14-11, 17-29
- alarm reset possibility - - - - - 15-5
- clearing INDEXER alarm history - - - - - 15-52
- displaying INDEXER alarm history - - - - - 15-51
- INDEXER module alarm displays and
 - troubleshooting - - - - - 15-46
- list of alarms - - - - - 15-5
- resetting INDEXER alarms - - - - - 15-49
- stopping method for servo OFF - - - - - 5-36
- troubleshooting alarms - - - - - 15-13

- ALM - - - - - 6-7
- Analog Monitor Connector - - - - - 4-50
- analog monitor factors- - - - - 9-11
- anti-resonance control- - - - - 8-49
- automatic detection of connected motor - - - - - 5-14
- automatic gain switching - - - - - 8-64
- automatic notch filters - - - - - 8-31
- autotuning with a host reference - - - - - 8-34
- autotuning without a host reference - - - - - 8-23
- Average Position Reference Movement Time - - - - - 12-5
- axis address - - - - - 14-5
 - axis address selection- - - - - 17-34
 - axis address setting - - - - - 14-5
- axis number- - - - - 14-7, 14-8, 14-10, 14-11

B

- backlash compensation - - - - - 8-71
- base block (BB) - - - - - xi
- battery
 - replacement - - - - - 15-3
- bit rate- - - - - 14-4, 14-6, 14-9
- block diagram - - - - - 2-11
- brake operation delay time - - - - - 5-31
- brake output - - - - - 5-32
- brake release delay time- - - - - 5-31

C

- CCW- - - - - 5-15
- clear hold - - - - - 14-12, 14-16, 14-19, 14-21
- CN1 - - - - - 4-36
- CN11 - - - - - 4-40
- CN12 - - - - - 4-45
- CN2 - - - - - 4-26
- CN3 - - - - - 4-50
- CN5 - - - - - 4-50
- CN7 - - - - - 4-50
- CN8 - - - - - 4-48
- coasting - - - - - 5-35
- coefficient of speed fluctuation - - - - - 2-10
- /COIN - - - - - 8-65

- command - - - - - 14-7, 14-10
 command/response format - - - - - 14-7
 communications protocol - - - - - 14-6
 compatible adjustment functions - - - - - 8-84
 Computer Connector - - - - - 4-50
 connecting a safety function device - - - - - 11-12
 consecutive stops - - - - - 13-39
 coordinates
 coordinates setting - - - - - 14-13, 14-14
 countermeasures against noise - - - - - 4-6
 current control mode selection - - - - - 8-70
 current gain level setting - - - - - 8-70
 cursor - - - - - 17-9
 custom tuning - - - - - 8-41
 CW - - - - - 5-15
- D**
- DC power supply input - - - - - 4-13
 setting - - - - - 5-12
 DC Reactor
 terminals - - - - - 4-12
 wiring - - - - - 4-25
 DEC - - - - - 13-13
 decelerating to a stop - - - - - 5-35
 deceleration - - - - - 14-16
 Deceleration Rate - - - - - 12-4
 delimiter - - - - - 14-7, 14-8, 14-9, 14-11
 detection timing for Overload Alarms (A.720) - - - - - 5-40
 detection timing for Overload Warnings (A.910) - - - - - 5-39
 diagnostic output circuits - - - - - 4-49
 diagnostic tools - - - - - 8-88
 Digital Operator - - - - - 17-8
 DTR/DSR control - - - - - 14-4
 dynamic brake - - - - - 5-28
 dynamic brake applied - - - - - 5-35
 dynamic brake stopping - - - - - 5-35
- E**
- EasyFFT - - - - - 8-89
 echoback - - - - - 14-7, 14-9
 echoback response time - - - - - 14-9
 EDM1 (External Device Monitor) signal - - - - - 11-8
 electronic gear - - - - - 5-41
 EMC installation conditions - - - - - 3-9
 encoder divided pulse output - - - - - 6-15, 10-7
 setting - - - - - 6-20
 signals - - - - - 6-15
 encoder resolution - - - - - 5-43, 6-20
 errors
 INDEXER module error displays
 and troubleshooting - - - - - 15-65
 status display - - - - - 15-65
 estimating the moment of inertia - - - - - 8-15
- EVENT - - - - - 13-13
 EVENT examples - - - - - 13-42
 External Regenerative Resistor - - - - - 5-54
- F**
- feedback pulse counter - - - - - 5-22
 feedforward - - - - - 8-84
 feedforward compensation - - - - - 8-84
 FG - - - - - 4-37
 forward direction - - - - - 10-6
 Forward Jog Input - - - - - 6-6
 forward rotation - - - - - 5-15
 framing error - - - - - 14-10
 friction compensation - - - - - 8-32, 8-67
 full-duplex wiring - - - - - 4-46, 14-4, 14-7, 14-9
 fully-closed system - - - - - 10-2
- G**
- gain switching - - - - - 8-64
 global commands - - - - - 14-8
 gravity compensation - - - - - 8-69
 grounding - - - - - 4-9
 group 1 alarms - - - - - 5-36
 group 2 alarms - - - - - 5-36
- H**
- half-duplex wiring - - - - - 4-46, 14-4, 14-7, 14-9
 Hall Sensor - - - - - 14-35
 hard wire base block (HWBB) - - - - - 11-3
 detecting errors in HWBB signal - - - - - 11-5
 hard wire base block (HWBB) state - - - - - 11-4
 HWBB input signal specifications - - - - - 11-5
 resetting - - - - - 11-4
 holding brake - - - - - 5-31
 homing - - - - - 13-4
 approach speed - - - - - 13-6
 creep speed - - - - - 13-6
 final travel distance - - - - - 13-6
 movement speed - - - - - 13-5
 starting - - - - - 14-12
 Homing Deceleration Switch Input - - - - - 6-3
 Homing Input - - - - - 6-5
 HWBB - - - - - 11-3
 detecting errors in HWBB signal - - - - - 11-5
 HWBB input signal specifications - - - - - 11-5
 HWBB state - - - - - 11-4
 HWBB state
 resetting - - - - - 11-4

I

I/O signals
 connection example - - - - - 4-42
 input signals- - - - - 4-36, 4-40
 monitoring - - - - - 9-3, 9-5
 output signals- - - - - 4-36, 4-41
 wiring example - - - - - 4-38
 incremental encoder - - - - - 14-14
 INDEXER
 alarm history display - - - - - 17-30
 parameter setting initialization - - - - - 17-28
 resetting alarms- - - - - 17-29
 status monitor - - - - - 17-25
 INDEXER Module
 indicators - - - - - 1-11
 introduction - - - - - 1-4
 nameplate - - - - - 1-7
 power loss - - - - - 2-5
 initializing the vibration detection level - - - - - 6-32
 INPOSITION Width - - - - - 13-12
 internal torque limits - - - - - 6-22
 I-P control - - - - - 8-80

J

JOG forward/reverse - - - - - 14-20
 jog operation - - - - - 7-6
 JOG speed table - - - - - 13-44, 14-29
 editing JOG speed tables - - - - - 17-19
 jog speed selection - - - - - 13-45
 JOG speed table initialization - - - - - 17-23
 JOG speed table setup commands - - - - - 14-29
 jog speeds - - - - - 13-44
 saving JOG speed tables - - - - - 17-20
 Jog Speed Table Selection Inputs - - - - - 6-6

L

latch - - - - - 14-21
 limiting torque - - - - - 6-22
 linear encoder
 feedback resolution - - - - - 5-44
 scale pitch setting - - - - - 5-16
 wiring example - - - - - 4-27
 Linear Servomotor - - - - - xi
 line-driver output circuits- - - - - 4-44
 list of parameters - - - - - 16-3
 LOOP - - - - - 13-13

M

Main Circuit Cable - - - - - xi
 manual tuning - - - - - 8-73
 mechanical analysis - - - - - 8-88
 Mode Switch Input - - - - - 6-4
 mode switching (changing between proportional
 and PI control) - - - - - 8-84
 Momentary Power Interruption Hold Time- - - - - 6-11
 monitor
 monitor and utility function commands - - - - - 14-32
 monitor display function- - - - - 17-4
 monitor factors - - - - - 9-11
 motor current detection signal
 automatic adjustment - - - - - 6-36
 manual adjustment - - - - - 6-38
 offset - - - - - 6-36
 motor direction setting- - - - - 5-15
 motor maximum speed - - - - - 6-14
 motor overload detection level - - - - - 5-39
 multiturn limit - - - - - 6-25
 Multiturn Limit Disagreement - - - - - 6-26
 multi-turn limit setting - - - - - 14-36

N

/NEAR - - - - - 8-65
 NEAR (Near Output) Signal - - - - - 8-65
 NEAR Width - - - - - 13-12
 negative responses - - - - - 14-10
 NEXT - - - - - 13-13
 Noise Filter - - - - - 4-7
 Noise Filter wiring and connection precautions - - - - - 4-8
 N-OT- - - - - 5-27
 N-OT (Reverse Drive Prohibit) signal - - - - - 5-27
 notch filters - - - - - 8-76

O

OK - - - - - 14-6
 structure of the OK response- - - - - 14-10
 OK response - - - - - 14-10
 operation for momentary power interruptions- - - - - 6-11
 origin- - - - - 13-5
 origin search - - - - - 7-19
 output phase form - - - - - 6-16
 overheat protection - - - - - 6-40
 Overheat Protection Input - - - - - 4-36
 overload warnings - - - - - 5-39
 overrun error - - - - - 14-10
 overtravel - - - - - 5-27, 14-13
 warnings - - - - - 5-29

P

- PAO - - - - - 6-15, 10-7
- parameter settings recording table - - - - - 16-31
- parameters - - - - - 14-30
- classification - - - - - 5-3
 - corresponding parameter numbers - - - - - 17-34
 - initializing parameter settings - - - - - 5-10
 - notation (numeric settings) - - - - - xii, 5-4
 - notation (selecting functions) - - - - - xii, 5-4
 - parameter edit commands - - - - - 14-30
 - setting methods - - - - - 5-5
 - write prohibition setting - - - - - 5-6
- parity - - - - - 14-4
- parity error - - - - - 14-10
- PBO - - - - - 6-15, 10-7
- PCO - - - - - 6-15, 10-7
- PGM STEP - - - - - 13-13
- photocoupler input circuits - - - - - 4-43
- photocoupler output circuits - - - - - 4-44
- PI control - - - - - 8-80
- polarity detection - - - - - 5-24
- polarity sensor - - - - - 5-23
- POS - - - - - 13-13
- position error - - - - - 6-9
- position integral - - - - - 8-87
- position loop gain - - - - - 8-74
- positioning
- positioning completion output signal - - - - - 6-9
 - positioning interruption - - - - - 14-22
 - positioning speed - - - - - 14-15
 - positioning start - - - - - 14-16, 14-17
 - positioning stop - - - - - 14-24
 - target position - - - - - 14-15
- positioning speed - - - - - 12-4
- positioning start - - - - - 14-17
- positioning start with registration - - - - - 14-20
- positive responses - - - - - 14-10
- P-OT - - - - - 5-27
- P-OT (Forward Drive Prohibit) signal - - - - - 5-27
- POUT - - - - - 13-13, 14-24
- program jog operation - - - - - 7-13
- operation pattern - - - - - 7-13
- Program Step Number - - - - - 6-10
- Program Step Selection Inputs - - - - - 6-7
- program table - - - - - 13-9, 14-24
- Acceleration rate - - - - - 13-13
 - Deceleration rate - - - - - 13-13
 - End condition - - - - - 13-13
 - Next program step - - - - - 13-13
 - Number of loops - - - - - 13-13
 - Positioning speed - - - - - 13-13
 - Program step - - - - - 13-13
 - program table edit - - - - - 17-12
 - program table initialization - - - - - 17-21
 - program table operation commands - - - - - 14-28
 - program table setup commands - - - - - 14-24
 - Programmable output specification - - - - - 13-13
 - Registration distance - - - - - 13-13
 - Registration speed - - - - - 13-13
 - saving program tables - - - - - 17-16
 - state transitions - - - - - 13-26
 - Target position - - - - - 13-13
- Program Table Operation Reset Input - - - - - 6-5
- Program Table Operation Start-Stop Input - - - - - 6-4
- programmable output signal - - - - - 14-24

R

- RDST - - - - - 13-13
- reactor
- DC Reactor terminals - - - - - 4-12
 - wiring AC reactors - - - - - 4-25
 - wiring DC reactors - - - - - 4-25
- reference unit - - - - - 5-41
- Regenerative Resistor
- connection - - - - - 4-23
- regenerative resistor - - - - - 5-54
- regenerative resistor capacity - - - - - 5-54
- registration
- JOG forward/reverse with registration - - - - - 14-21
 - positioning start with registration - - - - - 14-19
 - registration distance - - - - - 13-10
 - registration distance specification - - - - - 14-18
 - Registration Input - - - - - 6-4
 - registration operation - - - - - 13-10
 - registration speed specification - - - - - 14-18
- registration speed - - - - - 12-4
- resetting alarms detected in Option Modules - - - - - 15-53
- response - - - - - 14-6, 14-7, 14-8, 14-10, 14-11
- command/response format - - - - - 14-7
 - OK response - - - - - 14-6
 - response data details - - - - - 14-10

reverse direction - - - - - 10-6
 Reverse Jog Input - - - - - 6-6
 risk assessment - - - - - 11-3
 Rotary Servomotor - - - - - xi
 RS-422 - - - - - 4-46, 14-4
 RS-485 - - - - - 4-46, 14-4
 RSPD - - - - - 13-13
 RTS/CTS control - - - - - 14-4

S

Safety Function Signals - - - - - 4-48
 safety functions - - - - - 11-2
 application examples - - - - - 11-9
 precautions - - - - - 11-2
 verification test - - - - - 11-11
 safety input circuits - - - - - 4-48
 scale pitch - - - - - 5-16
 selecting the phase sequence for a Linear
 Servomotor - - - - - 5-21
 selecting torque limits - - - - - 6-22
 SEMI F47 function - - - - - 6-12
 serial commands - - - - - 14-11
 alphabetical list - - - - - 17-31
 command communications - - - - - 14-4
 command/response format - - - - - 14-7
 parameters related to serial communications - - - - - 14-6
 Serial Communications Connector - - - - - 4-50
 serial communications methods - - - - - 2-10
 Serial Converter Unit - - - - - 5-16
 Servo Alarm Output - - - - - 6-7
 Servo Drive - - - - - xi
 servo gains - - - - - 8-73
 servo lock - - - - - xi
 Servo OFF - - - - - xi, 14-11
 Servo ON - - - - - xi, 6-3, 14-11
 Servo Ready - - - - - 6-8
 Servo System - - - - - xi
 Servomotor - - - - - xi
 Servomotor stopping method for alarms - - - - - 5-36
 SERVOPACK - - - - - xi
 inspections and part replacement - - - - - 15-2
 part names - - - - - 1-8
 ratings - - - - - 2-2
 specifications - - - - - 2-7
 status displays - - - - - 1-10
 setting the origin - - - - - 5-51
 setting the position deviation overflow alarm level - - - - - 8-7
 setting the position deviation overflow alarm level
 at servo ON - - - - - 8-9
 setting the vibration detection level - - - - - 8-9
 setting the warning code output - - - - - 6-8
 setup parameters - - - - - 5-3
 SG - - - - - 4-37

SigmaWin+ - - - - - xi
 single-phase, 100-VAC power supply input
 wiring example - - - - - 4-21
 single-phase, 200-VAC power supply input
 setting - - - - - 5-13
 wiring example - - - - - 4-18
 sink circuits - - - - - 4-43
 software limit - - - - - 14-13
 software reset - - - - - 6-30
 source circuits - - - - - 4-43
 SPD - - - - - 13-13
 speed detection method selection - - - - - 8-71
 speed loop gain - - - - - 8-75
 speed loop integral time constant - - - - - 8-75
 Spring Opener - - - - - 4-14
 start bit - - - - - 14-4, 14-9
 status display - - - - - 17-9
 Status Monitor - - - - - 9-3
 stop bit - - - - - 14-4, 14-9
 stopping by applying the dynamic brake - - - - - 5-35
 storage humidity - - - - - 2-7
 storage temperature - - - - - 2-7
 surrounding air humidity - - - - - 2-7
 surrounding air temperature - - - - - 2-7
 switching condition A - - - - - 8-64

T

test without a motor - - - - - 7-21
 TH - - - - - 4-36
 three-phase, 200-VAC power supply input - - - - - 4-12
 setting - - - - - 5-13
 torque reference filter - - - - - 8-76
 trial operation
 digital I/O and serial communications - - - - - 7-9
 tuning parameters - - - - - 5-4
 tuning-less
 load level - - - - - 8-13
 rigidity level - - - - - 8-13
 tuning-less function - - - - - 8-11

U

utility function - - - - - 14-32, 17-2, 17-10

V

vibration suppression - - - - - 8-54

W

Warning - - - - - 6-8
 warning
 list of warnings - - - - - 15-57
 troubleshooting warnings - - - - - 15-59
 writing parameters - - - - - 5-17

X

X-ON/X-OFF control - - - - -14-4

Z

Zero-speed Stopping - - - - -5-35

ZONE

 editing ZONE tables - - - - -17-17

 saving ZONE tables - - - - -17-18

ZONE Output - - - - -6-10, 13-52

ZONE table - - - - -13-52, 14-29

 ZONE N - - - - -13-52

 ZONE P - - - - -13-52

 ZONE signals - - - - -13-52

 ZONE table initialization - - - - -17-22

Revision History

The revision dates and numbers of the revised manuals are given on the bottom of the back cover.

MANUAL NO. SIEP S800001 64I <9>-1
 Web revision number
 Revision number
 Published in Japan February 2020
 Date of publication

Date of Publication	Rev. No.	Web Rev. No.	Section	Revised Contents
November 2024	<16>	0	All chapters	Partly revised.
April 2024	<15>	0	Preface, 3.4, 3.7, 5.5, 5.14.1, 6.5.1	Partly revised.
September 2023	<14>	0	2.1.1, 4.2, 4.4.3, 4.5.4, 15.2.2	Partly revised.
			Back cover	Revision: Address
February 2023	<13>	0	Preface, 1.3, 3.7, 6.12.1, 15.2.2	Partly revised.
September 2022	<12>	0	8.12.1, 9.3.3, 10.3.2, 15.2.1, 15.2.2, 16.2.2	Partly revised.
			Back cover	Revision: Address
February 2022	<11>	0	Preface, 5.16, 6.7.3, 6.11.1, 6.11.2, 7.6.2, 15.2.2	Partly revised.
			Back cover	Revision: Address
August 2021	<10>	0	All chapters	Partly revised.
August 2020	<9>	2	Preface, 2.1.4, 4.1.3, 4.3.1, 5.14.1, 6.5.2, 8.5.1, 8.5.4, 15.2.1	Partly revised.
February 2020		1	4.4.3, 5.14.1, 5.16	Addition: Information on Linear Encoders from Canon Precision Inc.
			Back cover	Revision: Address
October 2019		0	All chapters	Partly revised.
March 2019	<8>	0	5.1.4, 7.6.3	Revision: Information in table of restrictions
			9.2.2, 9.2.3, 15.2.7, 15.2.8, 17.1.1	Partly revised.
			15.2.4	Addition: Reset procedure with the SigmaWin+
			Back cover	Revision: Address
September 2018	<7>	0	All chapters	Partly revised.
			2.1.1	Revision: Built-in regenerative resistor power loss for SGD7S-120A, -180A, -200A
			4.3.1	Revision: Specification of control power supply terminals
			4.4.3, 5.14.1	Addition: Absolute linear encoder from Fagor Automation S. Coop.
			5.1.4, 7.6.2, 7.6.3	Addition: Information on applicable tools regarding Linear Servomotor
			8.11.3	Revision: Enable timing for Pn423 = n.□□□X
			Back cover	Revision: Address

Date of Publication	Rev. No.	Web Rev. No.	Section	Revised Contents
January 2018	<6>	0	Preface, 1.6.3, 1.7.1, 5.11.1, 5.14.1	Addition: Information on Rotary Servomotors (SGM7M models)
			1.2	Revision: Information on nameplate
			1.7.3	Addition: Information on SGLFW2-90A200A□L, SGLFW2-90A560A, and SGLFW2-1DA560A
			5.10, 5.11.2, 6.1, 12.1, 12.3.1, 12.4.1, 13.2, 13.3, 14.3.3, 14.6, 14.7.1, 14.8.2, 15.2.3, 15.3.3, 16.2.2, 16.3, 17.4	Revision: Setting of PnB00 to PnB20, PnB31 and PnB32
			Chapter 15	Deletion: A.F50
			Back cover	Revision: Address
March 2017	<5>	0	Preface, 12.5	Partly revised.
			4.4.3, 5.14.1	Addition: Information on SQ47 and SQ57 Linear Encoders from Magnescale Co., Ltd.
			5.14.1	Addition: Information on LIC2100-Series and LC415 Linear Encoders from Heidenhain Corporation.
			5.14.1, 5.16	Addition: Information on RESOLUTE Linear Encoders from Renishaw PLC.
			15.2.2, 16.2.2	Revision: Reference information
Back cover	Revision: Address			
December 2016	<4>	0	Preface	Partly revised.
			1.6.3, 4.4.2, 4.4.3, 5.14.1, 5.15, 6.7	Addition: Information on Rotary Servomotors with 24-bit batteryless absolute encoders.
November 2016	<3>	0	Preface	Partly revised.
			1.7.2	Addition: Information on Direct Drive Servomotors (SGM7F-□□A, -□□M, -□□N)
			4.4.3, 5.14.1, 5.16	Addition: Information on Renishaw PLC EVOLUTE linear scales
September 2016	<2>	0	All chapters	Addition: Information on Direct Drive Servomotors (SGM7E and SGM7F models) Deletion: Information on Linear Servomotors (SGLC models)
			Preface, 9.1, 9.2	Partly revised.
			2.1.1	Addition: Information on input current from control power supply
			2.1.3, 4.2, 4.5	Revision: "Linear Servomotor overheat protection signal input" changed to "overheat protection input."
			3.7	Addition: EMC installations for single-phase 200-VAC and single-phase 100-VAC models.
			6.14, 8.12.3	Newly added.
			Chapter 15	Addition: A.862 and A.93B
			Chapter 16	Addition: Pn022, Pn475, Pn476, Pn61A, Pn61B, Pn61C, and Pn61D Deletion: Pn52D
			17.1.2	Addition: Un02F
			Back cover	Revision: Address
November 2015	<1>	0	Front cover	Revision: Format
			All chapters	Completely revised
			Back cover	Revision: Format and address
March 2015	-	-	-	First edition

Σ-7-Series AC Servo Drive

Σ-7S SERVOPACK

Command Option Attachable Type with INDEXER Module

Product Manual

IRUMA BUSINESS CENTER (SOLUTION CENTER)

480, Kamifujisawa, Iruma, Saitama, 358-8555, Japan
Phone: +81-4-2962-5151 Fax: +81-4-2962-6138
www.yaskawa.co.jp

YASKAWA AMERICA, INC.

2121, Norman Drive South, Waukegan, IL 60085, U.S.A.
Phone: +1-800-YASKAWA (927-5292) or +1-847-887-7000 Fax: +1-847-887-7310
www.yaskawa.com

YASKAWA ELÉTRICO DO BRASIL LTDA.

777, Avenida Piraporinha, Diadema, São Paulo, 09950-000, Brasil
Phone: +55-11-3585-1100 Fax: +55-11-3585-1187
www.yaskawa.com.br

YASKAWA EUROPE GmbH

Philipp-Reis-Str. 6, 65795 Hattersheim am Main, Germany
Phone: +49-6196-569-300 Fax: +49-6196-569-398
www.yaskawa.eu.com E-mail: info@yaskawa.eu.com

YASKAWA ELECTRIC KOREA CORPORATION

6F, 112, LS-ro, Dongan-gu, Anyang-si, Gyeonggi-do, Korea
Phone: +82-31-8015-4224 Fax: +82-31-8015-5034
www.yaskawa.co.kr

YASKAWA ASIA PACIFIC PTE. LTD.

30A, Kallang Place, #06-01, 339213, Singapore
Phone: +65-6282-3003 Fax: +65-6289-3003
www.yaskawa.com.sg

YASKAWA ELECTRIC (THAILAND) CO., LTD.

59, 1F-5F, Flourish Building, Soi Ratchadapisek 18, Ratchadapisek Road, Huaykwang, Bangkok, 10310, Thailand
Phone: +66-2-017-0099 Fax: +66-2-017-0799
www.yaskawa.co.th

YASKAWA ELECTRIC (CHINA) CO., LTD.

22F, Link Square 1, No.222, Hubin Road, Shanghai, 200021, China
Phone: +86-21-5385-2200 Fax: +86-21-5385-3299
www.yaskawa.com.cn

YASKAWA ELECTRIC (CHINA) CO., LTD. BEIJING OFFICE

Room 1011, Tower W3 Oriental Plaza, No.1, East Chang An Avenue,
Dong Cheng District, Beijing, 100738, China
Phone: +86-10-8518-4086 Fax: +86-10-8518-4082

YASKAWA ELECTRIC TAIWAN CORPORATION

12F, No. 207, Section 3, Beishin Road, Shindian District, New Taipei City 23143, Taiwan
Phone: +886-2-8913-1333 Fax: +886-2-8913-1513 or +886-2-8913-1519
www.yaskawa.com.tw

YASKAWA

YASKAWA ELECTRIC CORPORATION

In the event that the end user of this product is to be the military and said product is to be employed in any weapons systems or the manufacture thereof, the export will fall under the relevant regulations as stipulated in the Foreign Exchange and Foreign Trade Regulations. Therefore, be sure to follow all procedures and submit all relevant documentation according to any and all rules, regulations and laws that may apply. Specifications are subject to change without notice for ongoing product modifications and improvements.

© 2015 YASKAWA ELECTRIC CORPORATION

MANUAL NO. SIEP S800001 64P <16>-0

Published in Japan November 2024

23-4-19

Original instructions